

ILHR 82

APPENDIX

The material contained in this appendix is for clarification purposes only. The notes, illustrations, etc., are numbered to correspond to the number of the rule as it appears in the text of the code.

A-82.11 (29) BRANCH INTERVALS.

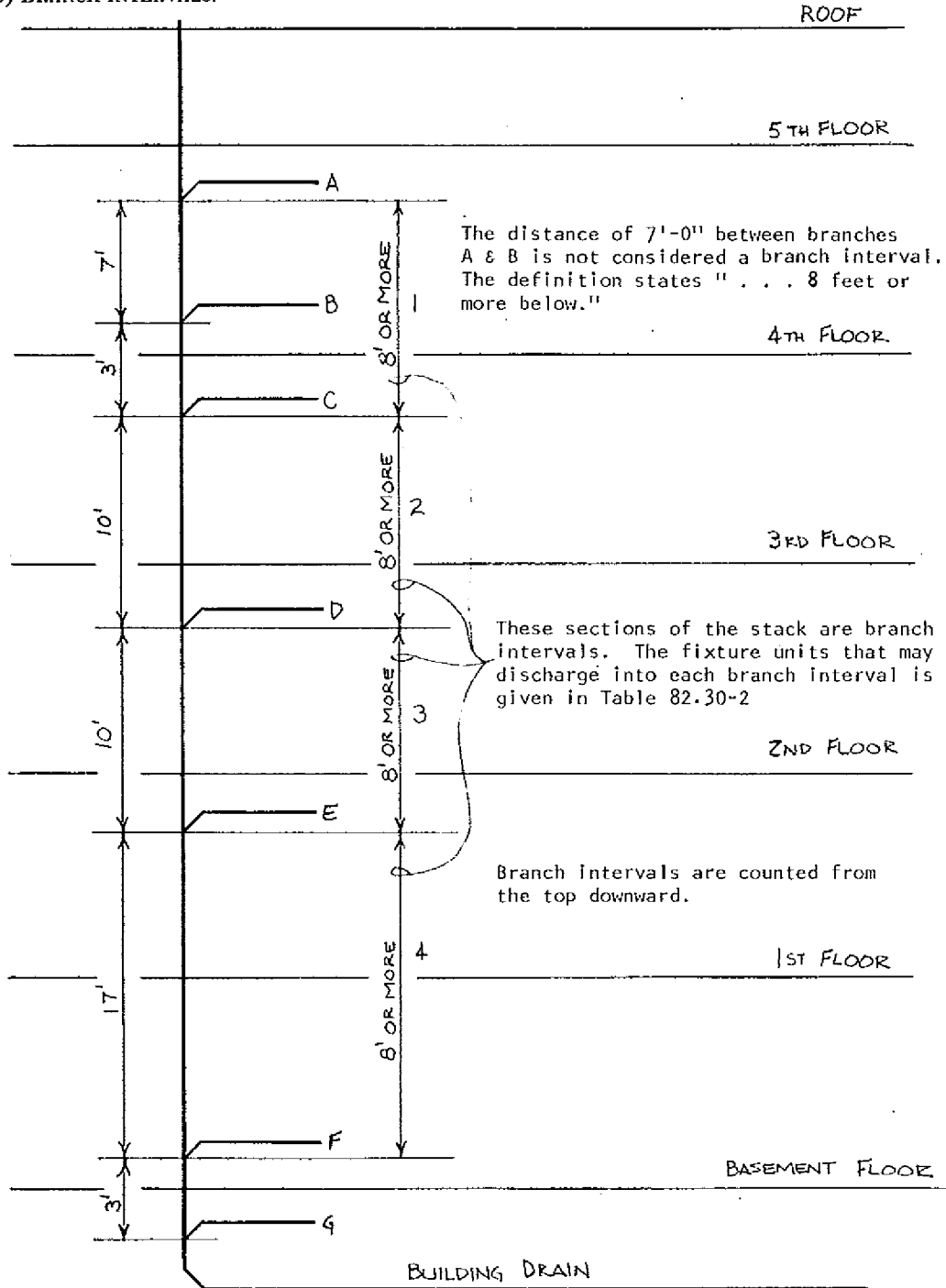

ILHR 82 Appendix

A-82.11 (140) SPRINGLINE OF PIPE.

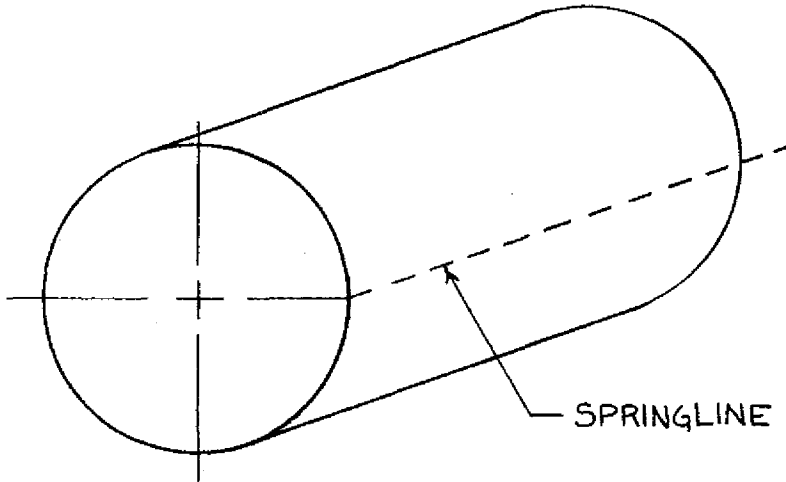

On a round pipe the springline is along the horizontal centerline.

A-82.20 and A-82.21 FORMS. The following forms (DILHR SBD-8, SBD-6154, 6115, 6479 and 6192) are used by the department in administration of this administrative code. Copies of these forms are available from the Division of Safety and Buildings, Bureau of Building Water Systems, P.O. Box 7969, Madison, Wisconsin 53707.

Wisconsin Department of Industry,
Labor and Human Relations
Safety and Buildings Division

**GENERAL PLUMBING
PLAN APPROVAL APPLICATION**

Bureau of Building Water Systems
201 E. Washington Avenue, Rm 141
P.O. Box 7969, Madison, WI 53707-7969
608-266-3815
FAX 608-267-0592

NOTE: Appointments for plan review should be made prior to submittal by calling any one of the offices shown at the bottom of this form.

INSTRUCTIONS: This form is required with each general plumbing plan submittal. Please complete both sides. Examination fees, as determined on this form, must accompany submittal. Data required in submittal is described on the reverse side of form.

| | | | | |
|--|-------|-----|---|-----------------------------------|
| 1. PROJECT INFORMATION (type or print clearly) | | | Plan Review Appointment Date | Plan Identification Number |
| Name of Submitting Party (Plans returned to same) | | | Project Name | |
| Street & No. | | | Project Location - Street & No. | |
| City | State | Zip | City <input type="checkbox"/> | County |
| | | | Village <input type="checkbox"/> OF: | |
| | | | Town <input type="checkbox"/> | |
| Telephone No. (Include area code) | | | Designer (Plumbing) | Telephone No. (Include area code) |
| 2. PLANS FOR: | | | Owners Name | Telephone No. (Include area code) |
| <input type="checkbox"/> New Building | | | <input type="checkbox"/> Addition/Remodel | |
| <input type="checkbox"/> Revision to plumbing plan No. _____ | | | Street & No. (current address) | |
| 2a. Fee For Revisions - \$60.00 | | | City | State |
| | | | Zip | |

| Office Use Only | 3. THIS APPLICATION FOR: | | | 4. FEE SUBMITTED | Office Use Only |
|-----------------|---------------------------|---|---|------------------|-----------------|
| | Check Appropriate Box(es) | | | | |
| 20. | 3a. | <input type="checkbox"/> Sanitary Building Sewer Only (no drain and vent) | Sum of Sanitary Sewer Diameters _____ Inches X \$20.00 = | 4a. | |
| 21. | 3b. | <input type="checkbox"/> Sanitary Drain and Vent, with or w/o Sanitary Sewer | Sum of Sanitary Sewer Diameters _____ Inches x \$35.00 = | 4b. | |
| 22. | 3c. | <input type="checkbox"/> Sanitary Private Interceptor Main Sewer | Sum of Largest Diameters _____ Inches x \$20.00 = | 4c. | |
| 23. | 3d. | <input type="checkbox"/> Building Water Service Only (no water distribution system) | Sum of Water Service Diameters _____ Inches x \$20.00 = | 4d. | |
| 24. | 3e. | <input type="checkbox"/> Water Distribution System with or w/o Water Service | Sum of Water Service Diameters _____ Inches x \$35.00 = | 4e. | |
| 25. | 3f. | <input type="checkbox"/> Private Water Main | Sum of Water Main Diameters _____ Inches x \$20.00 = | 4f. | |
| 27. | 3g. | <input type="checkbox"/> Building Storm and Clear Water Drain System | Sum of Storm Sewer Diameters _____ Inches x \$ 8.00 = | 4g. | |
| 28. | 3h. | <input type="checkbox"/> Storm Private Interceptor Main Sewer | Sum of Largest Diameters _____ Inches x \$ 8.00 = | 4h. | |
| 29. | 3i. | <input type="checkbox"/> Controlled Roof Drainage System (Does Not Include Conventional Building Storm Piping) | \$60.00 Required = | 4i. | |
| 32. | 3j. | <input type="checkbox"/> Reduced Pressure Principle Backflow Preventer | Number of Valves _____ x \$110.00 = | 4j. | |
| 33. | 3k. | <input type="checkbox"/> Reduced Pressure Principle Detector Assembly Backflow Preventer | Number of Valves _____ x \$110.00 = | 4k. | |
| 34. | 3l. | <input type="checkbox"/> Vacuum Breaker - Antisiphon Pressure Type | Number of Valves _____ x \$110.00 = | 4l. | |
| 35. | 3m. | <input type="checkbox"/> Grease Interceptor * (See Note Below) | Number of Grease Interceptors _____ x \$60.00 = | 4m. | |
| 36. | 3n. | <input type="checkbox"/> Chemical Waste System * (See Note Below) | Number of Chemical Waste Systems _____ x \$60.00 = | 4n. | |
| 37. | 3o. | <input type="checkbox"/> Garage Catch Basin * (See Note Below) | Number of Garage Catch Basins _____ x \$60.00 = | 4o. | |
| 38. | 3p. | <input type="checkbox"/> Oil Interceptor * (See Note Below) | Number of Oil Interceptors _____ x \$60.00 = | 4p. | |
| 39. | 3q. | <input type="checkbox"/> Car Wash Interceptor * (See Note Below) | Number of Car Wash Interceptors _____ x \$60.00 = | 4q. | |
| 40. | 3r. | <input type="checkbox"/> Sanitary Dump Station * (See Note Below) | Number of Sanitary Dump Stations _____ x \$60.00 = | 4r. | |
| | 3s. | <input type="checkbox"/> Mobile Home Parks and Campground/Recreational Vehicle Parks | 1-25 Sites \$250.00 26-50 Sites \$300.00 51-125 Sites \$350.00 Over 125 Sites \$400.00 | = | 4s. |
| | 3t. | <input type="checkbox"/> Engineered Plumbing System (Minimum \$225.00- Calculate Fee in Accord with ITEM 8 - See Reverse Side of this Form) | | = | 4t. |
| | 3u. | <input type="checkbox"/> Petition for Variance (must be submitted on form SB-8) | \$225.00 | = | 4u. |
| | | | SUBTOTAL = | | |
| | 3v. | <input type="checkbox"/> Priority Review | Enter Same Amount as Subtotal | = | 4v. |
| | | | TOTAL FEE (Minimum \$60.00) = | | |

NOTE: Appointments for plan review should be made prior to submittal. You may contact one of the offices listed below.

Hayward Office
209 West First Street, Hwy 63
Rt. 8, Box 8072
Hayward, WI 54843
Phone (715) 634-4804
FAX (715) 634-5150

LaCrosse Office
2226 Rose Street
LaCrosse, WI 54603
Phone (608) 785-9352
FAX (608) 785-9330

Madison Office
201 E. Washington Ave.
P.O. Box 7969
Madison, WI 53707-7969
Phone (608) 267-3606
FAX (608) 267-0592

Shawano Office
1053A E. Green Bay Street
P.O. Box 434
Shawano, WI 54166-0434
Phone (715) 524-3627
FAX (715) 524-3633

Waukesha Office
401 Pilot Court, Suite C
Waukesha, WI 53188
Phone (414) 548-8806
FAX (414) 548-8614

- CONTINUED ON REVERSE SIDE -

ILHR 82 Appendix

5. ENCLOSURES

- Enclosed
- Under separate cover, please find the following:
- Two sets of plans and
- Three sets of plans and
- One set of Specifications

Check Number _____ In the amount of _____ Written by: _____

MAKE ALL CHECKS PAYABLE TO DILHR, SAFETY & BUILDINGS DIVISION.

6. BACKFLOW PREVENTER DATA;

REDUCED PRESSURE PRINCIPLE BACKFLOW PREVENTER, REDUCED PRINCIPLE BACKFLOW DETECTOR ASSEMBLY BACKFLOW PREVENTER, AND VACUUM BREAKER-ANTI-SIPHON, PRESSURE TYPE.

Indicate Valve Size, Manufacturer, Model No., and Location in Building (Room No., etc.) for each valve attach additional sheets if necessary.

- 1. _____
- 2. _____
- 3. _____

7. PLAN SUBMITTAL SHALL INCLUDE THE FOLLOWING IN ACCORD WITH CODE SECTION ILHR 82.20.

- A. One complete set of plans and specifications (including materials and fixtures) with one additional copy of all plumbing drawings. Plans Shall Include:
- 1. Plot plan showing sanitary and/or storm sewer and water.
 - 2. Floor plan showing horizontal drains, water distribution mains and all fixtures and equipment to be installed.
 - 3. Isometric/riser diagrams of the drain, vent and water distribution systems, with pipe sizes and fixture unit loads shown.
 - 4. Complete water calculations in accord with s. ILHR 82.20(4)(a).
 - 5. Complete storm drain sizing calculations.
 - 6. Modeling or additions shall include existing loads.
 - 7. Quality Management Letter if required by s. ILHR 82.20(4)(c).
 - 8. All plans must be properly signed as per ILHR 82.20(4)(d) & (e).

8. EXAMINATION FEES FOR ADDITIONS AND REMODELING.

When new or relocated fixtures or both are connected to existing piping inside a building, the fee shall be determined in accordance with the following procedures:

A. 'Sanitary Building Sewer, Drain and Vent.'

- 1. Total all of the drainage fixture units that are being added or relocated using Table 82.30-1, Chapter ILHR 82.
- 2. Refer to Table 82.30-2, Chapter ILHR 82, and determine the horizontal drain size that would be required if all new or relocated fixtures discharged through one pipe.
- 3. Use that pipe size to determine fee based on line 3b which is found on the front of this form.

ILHR Table 2.64-2

| GPM | FEE |
|-----------|----------|
| 1 - 6 | \$17.00 |
| 7 - 12 | \$28.00 |
| 13 - 21 | \$35.00 |
| 22 - 31 | \$43.00 |
| 32 - 46 | \$52.00 |
| 47 - 77 | \$70.00 |
| 78 - 119 | \$87.00 |
| 120 - 170 | \$105.00 |
| 171 - 298 | \$122.00 |

B. 'Building Water Distribution System'

- 1. Total all of the water supply fixture units that are being added or relocated, using ILHR Tables 82.40-1 and 2, and convert to gallons per minute (GPM) in accordance with ILHR Table 82.40-3.
- 2. The fees shall be determined in accordance with the GPM demand of the new or relocated fixtures as specified in ILHR Table 2.64-2.

C. 'Building Storm Sewer and Drainage System.'

- 1. Total each different type of area that the new or relocated drains serve and convert to GPM using Tables 82.36-1, 2, and 3, Chapter ILHR 82. To this add the GPM discharge from any added or relocated clear water drains located inside the building.
- 2. Refer to Table 82.36-4, Chapter ILHR 82, using the column for 1/4" ft. pitch, determine the horizontal drain size that would be required if all new or relocated fixtures discharged through one pipe.
- 3. Use that pipe size to determine the fee based on line 3g which is found on the front of this form.

Wisconsin Department of Industry,
Labor and Human Relations

**PETITION FOR VARIANCE
APPLICATION**

Safety and Buildings Division
P.O. Box 7969
Madison, Wisconsin 53707
(608) 266-1542

Please type or print.

| OFFICE USE ONLY | Amount Paid | Receipt Number | Petition No. | E-Number |
|-------------------------|---------------------------|----------------|--------------------------------------|----------|
| Owner/Petitioner's Name | Building Or Project | | Agent, Architect or Engineering Firm | |
| Company | Tenant's Name, If Any | | Street Address | |
| Street Address | Location - Street Address | | City, State, Zip Code | |
| City, State, Zip Code | City, County | | Telephone Number { } | |
| Telephone Number | Plan Number, If Known | | Contact Person's Name | |

1. The rule being petitioned reads as follows (cite specific rule number and language; one rule per application):

2. The rule being petitioned cannot be entirely satisfied because:

SAMPLE

3. The following alternative(s) and supporting information are proposed as a means of providing an equivalent degree of health, safety or welfare as addressed by the rule:

Note: Please attach any pictures, plans, sketches or required position statements.

VERIFICATION BY OWNER - PETITION IS VALID ONLY IF NOTARIZED WITH AFFIXED SEAL AND ACCOMPANIED BY REVIEW FEE
See Section ILHR 2.52 for complete fee information

Note: Petitioner must be the owner of the building or project. Tenants, agents, designers, contractors, attorneys, etc., shall not sign petition unless Power of Attorney is submitted with the Petition For Variance Application

_____, being duly sworn, I state as petitioner that I have read the foregoing
Petitioner's Name (type or print)
petition and I believe it is true and that I have significant ownership rights to the subject building or project.

| | | | |
|-------------------------|--|---------------|---------------------------|
| Petitioner's Signature: | Subscribed And Sworn To Before Me This Date: | Notary Public | My Commission Expires On: |
|-------------------------|--|---------------|---------------------------|

ILHR 82 Appendix



REDUCED PRESSURE PRINCIPLE BACKFLOW PREVENTER TEST REPORT

Please print or type in all the information and return to Division of Safety & Buildings
 Bureau of Building Water Systems
 P.O. Box 7969, Madison, WI 53707

Plan ID No. _____

Manufacturer _____ Model _____ Size _____ Serial No. _____

Name of Project _____ County _____

Address (street, city, zip) _____

| | Check Valve #1 | Check Valve #2 | Relief Valve | Comments |
|---------------------|---|---|--|----------|
| INITIAL TEST | Leaked _____ Closed tight _____ at _____ psid | Leaked _____ Closed tight _____ at _____ psid | Opened at _____ psid Did not open _____ | |
| REPAIRS | Cleaned _____ Replaced: disc _____ spring _____ guide _____ pin retainer _____ hinge pin _____ seat _____ diaphragm _____ other, _____ describe _____ | Cleaned _____ Replaced: disc _____ spring _____ guide _____ pin retainer _____ hinge pin _____ seat _____ diaphragm _____ other, _____ describe _____ | Cleaned _____ Replaced: disc _____ upper _____ lower _____ ring _____ diaphragm: large: _____ upper _____ lower _____ small _____ seat: _____ upper _____ lower _____ spacer: _____ lower _____ other, _____ describe _____ | |
| FINAL TEST | Closed tight _____ at _____ psid | Closed tight _____ at _____ psid | Opened at _____ psid | |

FOR TESTING OF A REPLACEMENT VALVE: If this test is for a replacement valve, please include all information for the replacement valve on this form, and include the same identifying information for the old valve on the back of this form.

The above report is certified to be true.

Initial test by _____ Tester No. _____ Date _____

Tester telephone no. (____) - _____

Repaired by _____ Repair date _____

Final test by _____ Tester No. _____ Date _____

Tester telephone no. (____) - _____

SBD-6115 (R 03/92)

WATER CALCULATION WORKSHEET

Information Needed for Water Service Sizing

1. _____ Demand of building in gallons per minute.
2. _____ Low pressure at main in street (or at external pressure tank).
3. _____ Difference in elevation from main to meter (or external pressure tank to building control valve).
4. _____ Size of water meter (if applicable).
5. _____ Developed length from main to meter (or external pressure tank to building control valve).

You Must First Find the Available Pressure After the Water Meter (or at building control valve). To obtain this pressure, you must:

6. _____ Find pressure loss due to friction in _____ inch diameter water service.
7. _____ Find pressure loss due to elevation, main to meter (or external pressure tank to building control valve). Multiply the difference in elevation by .434 p.s.i./ft.
8. _____ Find pressure loss due to meter _____ manufacturer or AHWA).
9. _____ Subtract the loss due to friction (Step 6), loss due to elevation (Step 7), and loss due to meter (Step 8) from the low main pressure (or low pressure at external pressure tank)(Step 2). This calculation is the available pressure after the water meter (or at the building control valve). This answer is entered in Line B, below.

Information Needed for Water Distribution Sizing

Using the following formula, find the pressure available for uniform loss (p.s.i./100' of pipe)

$$A = \frac{B - (C + D + E)}{F} \times 100$$

WHERE:

- A. _____ Pressure available for uniform loss (p.s.i./100' of pipe).
- B. _____ Available pressure after water meter (at the building control valve or low pressure at internal pressure tank). (See Step 9, above)
- C. _____ Pressure needed at controlling fixture.
- D. _____ Difference in elevation between water meter (building control valve or internal pressure tank) and controlling fixture in feet _____ x .434 p.s.i./ft.
- E. _____ Pressure loss due to water softeners, water treatment devices, instantaneous water heaters and backflow preventers which serve the controlling fixture. Conventional water heaters usually do not have a pressure loss.
- F. _____ Developed length from water meter (building control valve or internal pressure tank) to controlling fixture in feet _____ x 1.5

With pressure available for uniform loss, go to applicable table for distribution sizing.

ILHR 82 Appendix

Wisconsin Department of Industry,
Labor and Human Relations
Safety & Buildings Division
Bureau of Building Water Systems

**INSPECTION
REPORT**

| | | | |
|---------------------------------|---|--------------------------------------|---------------------|
| Inspection Date | | | |
| Name of Premises | Address or Legal Description | City/Township | County |
| Master Plumber Name and Address | | Master Plumber Firm Name and Address | Plan I.D. No. |
| | | | Sanitary Permit No. |
| Journeyman Plumber/Soil Tester | Licensed Person's Name(s) and License Number(s) | | |
| Owner's Name and Address | | | |

SAMPLE

Page _____ of _____

Signature of Responsible Licensed Person (only one needed)

Signature of Plumbing Consultant/Private Sewage Consultant

Original: District DILHR Plumber Owner County/Local Insp. Other _____

Copies to: (Check all that apply)

A-82.20 (2) AGENT MUNICIPALITIES. The department has designated to the following municipalities, the authority to review and approve plumbing plans and specifications for those plumbing installations to be located within the municipality's boundary limits and which require approval under s. ILHR 82.20 (1) (b).

Appleton

200 N. Appleton Street
Appleton, WI 54911-4799
(414) 832-6411

Eau Claire

203 South Farwell Street
Eau Claire, WI 54701
(715) 839-4947

Green Bay

100 N. Jefferson St., Rm. 403
Green Bay, WI 54301
(414) 448-3295

Greenfield

7325 W. Forest Home Ave.
Greenfield, WI 53220
(414) 543-5500, Ext. 332

Janesville

18 North Jackson Street
P.O. Box 5005
Janesville, WI 53546
(608) 755-3064

Kenosha

Kenosha City Hall
Dept. of Housing and
Neighborhood Development
625 52nd St., Rm. 100
Kenosha, WI 53140
(414) 653-4263

Madison

Building Insp. Dept., Rm. G100
215 M.L. King Jr. Blvd.
Madison, WI 53710
(608) 266-4568

Milwaukee

Municipal Bldg., Rm. 1013
841 N. Broadway Street
Milwaukee, WI 53202
(414) 278-2596

Oshkosh

P.O. Box 1130
Oshkosh, WI 54902
(414) 236-5049

Racine

730 Washington Avenue
Racine, WI 53403
(414) 636-9164

Sheboygan

City Hall - 3rd Floor
828 Center Avenue
Sheboygan, WI 53081
(414) 459-3479

Two Rivers

City Hall
P.O. Box 87
Two Rivers, WI 54241
(414) 793-5580

A-82.20 (4) The following is a list of Designated Management Agencies and the counties they serve.

DESIGNATED MANAGEMENT AGENCY

Clearing House Review Coordinator
East Central Wisconsin Regional Planning
Commission
132 Main Street
Menasha, WI 54952
(414) 751-4770

Dane County Regional Planning
Commission
217 South Hamilton, Room 403
Madison, WI 53703
(608) 266-4417

Brown County Planning Commission
Room 608, City Hall
100 North Jefferson Street
Green Bay, WI 54301
(414) 448-3400

Southeastern Wisconsin Regional Planning
Commission
916 North East Avenue
P.O. Box 1607
Waukesha, WI 53187-1607
(414) 547-6721

COUNTIES SERVED

Menominee, Shawano,
Waupaca, Outagamie,
Waushara, Marquette,
Green Lake, Winnebago,
Calumet, Fond du Lac

Dane

Brown

Washington, Ozaukee,
Waukesha, Milwaukee,
Walworth, Racine, Kenosha

ILHR 82 Appendix

The following is a list of Sewer Service Area Plans approved by the Department of Natural Resources. For each Sewer Service Area Plan the approved Planning Agency and affected communities are shown.

Contacts - Sewer service area plans

Affected Communities

Eau Claire - Chippewa Falls

West Central Wisconsin Regional Planning
Commission
800 Wisconsin Street
Suite D2-401
Eau Claire, WI 54703-3574
(715) 836-2918

City of Eau Claire
City of Altoona
City of Chippewa Falls
Town of Hallie
Town of Seymour
Town of Union
Town of Washington

Hudson

St. Croix County Planning Office
St. Croix Gov. Bldg.
1101 Carmichael Road
Hudson, WI 54016
(715) 386-4673

City of Hudson
Town of Hudson
Town of St. Joseph
Town of Troy
Village of North Hudson

Green Bay

Bay-Lake Regional Planning Commission
211 N. Broadway, Suite 211
Green Bay, WI 54303
(414) 448-2820

City of Marinette
City of Kohler
City of Sheboygan
City of Sheboygan Falls
Town of Peshtigo
Town of Porterfield
Town of Mosel
Town of Wilson
Town of Lima
Town of Herman
Town of Sheboygan
Town of Sheboygan Falls

Janesville

Rock County Planning Development
Agency
51 South Main Street, Courthouse
Janesville, WI 53545
(608) 757-5587

City of Janesville
City of Beloit
City of Edgerton
City of Evansville
City of Milton
Town of Beloit
Town of Harmony
Town of Rock
Town of Janesville
Town of La Prairie
Town of Turtle

La Crosse

Office of City Engineer
400 La Crosse Street
City Hall
La Crosse, WI 54601
(608) 789-7505

City of La Crosse
City of Onalaska
Town of Onalaska
Town of Shelby
Town of Medary
Town of Campbell

Stevens Point

Portage County Planning and Zoning
Department
1516 Church Street
Stevens Point, WI 54481
(715) 346-1334

City of Stevens Point
Town of Hull
Town of Plover
Town of Linwood
Village of Whiting
Village of Plover
Village of Park Ridge

Wausau

Marathon County Planning Department
500 Forest Street
Wausau, WI 54403
(715) 847-5227

City of Wausau
City of Schofield
Town of Weston
Town of Stettin
Town of Rib Mountain
Town of Kronenwetter
Village of Rothschild

Wisconsin Rapids

Office of County Planning & Zoning
400 Market Street
Wisconsin Rapids, WI 54495
(715) 421-8466

City of Wisconsin Rapids
Town of Grand Rapids
Town of Rudolph
Town of Sigel
Town of Seneca
Town of Grant
Village of Biron

A-82.20 (8) FEES. The following reprint of s. ILHR 2.64 (2) may be used to determine the amount of fee required for general plumbing plan review by the department.

ILHR 2.64 Plumbing systems. (1) GENERAL. Plan examination fees for preliminary or complete plans shall accompany the plans and specifications when submitted. If the department determines, upon review of the plans, that inadequate fees were provided, the necessary additional fees shall be provided prior to departmental approval.

(2) EXAMINATION FEES. The plan examination fee shall be determined in accordance with Table 2.64-1. The minimum fee shall be \$60.00 per plan.

Table 2.64-1

| Type of Review | Fee |
|---|--|
| 1. Sanitary drain and vent system | \$35.00 per inch diameter of each bldg. sewer |
| 2. Sanitary building sewer only, no drain and vent | \$20.00 per inch diameter of each bldg. sewer |
| 3. Building water distribution system | \$35.00 per inch diameter of each water service |
| 4. Building water service only, no water distribution system | \$20.00 per inch diameter of each water service |
| 5. Building storm and clear water drain system..... | \$8.00 per inch diameter of each bldg. storm sewer |
| *6. Car wash interceptor | \$60.00 per interceptor |
| *7. Garage catch basin..... | \$60.00 per basin |
| *8. Grease interceptor | \$60.00 per interceptor |
| *9. Oil interceptor | \$60.00 per interceptor |
| *10. Sanitary dump station | \$60.00 per station |
| *11. Chemical waste system..... | \$60.00 per system |
| 12. Controlled roof drainage system, does not include conventional building storm piping | \$60.00 per system |
| 13. Engineered plumbing system | minimum \$225.00 or as determined in sub. (3) |
| 14. Mobile home parks and campground/recreational vehicle parks: | |
| 1-25 sites | \$250.00 |
| 26-50 sites | \$300.00 |
| 51-125 sites | \$350.00 |
| Over 125 sites..... | \$400.00 |
| 15. Private water main | \$20.00 per inch diameter |
| 16. Cross connection control devices: | |
| Reduced pressure principle backflow preventer | \$110.00 per device |
| Reduced pressure detector assembly backflow preventer | \$110.00 per device |
| Vacuum Breaker - anti-siphon, pressure type | \$110.00 per device |
| 17. Sanitary private interceptor main sewers, determined on the largest diameter of each interceptor main sewer | \$20.00 per inch diameter |
| 18. Storm private interceptor main sewers, determined on the largest diameter of each interceptor main sewer | \$8.00 per inch diameter |

*Note: For table entries 6 to 11, no additional fee would be required if submitted with the sanitary drain and vent system.

(3) EXAMINATION FEES FOR ADDITIONS AND REMODELING. When new or relocated fixtures or both are connected to the existing piping inside a building, the fee shall be determined in accordance with the following procedures:

(a) *Sanitary building sewer, drain and vent.* 1. Total all of the drainage fixture units which are being added or relocated.

2. Refer to s. ILHR 82.30, Table 82.30-2, and determine the horizontal drain size which would be required if all new or relocated fixtures discharged through one pipe.

ILHR 82 Appendix

Note: Disregard the asterisk limitation regarding water closets. This pipe size is used for determining the fee only and does not necessarily mean this pipe size is used in actual design or installation.

3. Determine fee based on Table 2.64-1, entry 1.

(b) *Building water distribution system.* 1. Total all of the water supply fixture units which are being added or relocated, using s. ILHR 82.40, Tables 82.40-1 and 2, and convert to gallons per minute (GPM) in accordance with s. ILHR 82.40, Table 82.40-3.

2. The fees shall be determined in accordance with GPM demand of the new or relocated fixtures as specified in Table 2.64-2.

Table 2.64-2

| GPM | FEE |
|---------------|----------|
| 1-6 | \$ 17.00 |
| 7-12 | \$ 26.00 |
| 13-21 | \$ 35.00 |
| 22-31 | \$ 43.00 |
| 32-46 | \$ 52.00 |
| 47-77 | \$ 70.00 |
| 78-119 | \$ 87.00 |
| 120-170 | \$105.00 |
| 171-298 | \$122.00 |

(c) *Building storm sewer and drainage system.* 1. Total each different type of area which the new or relocated drains serve and convert to GPM using ch. ILHR 82, Tables 82.36-1, 2 and 3. To this, add the GPM discharge from any added or relocated clear water drains located inside the building.

2. Refer to ch. ILHR 82, Table 82.36-4, using the column for 1/4 inch per foot pitch, to determine the horizontal drain size which would be required if all new or relocated fixtures discharged through one pipe. Use this pipe size for determining the fee.

3. Determine the fee based on Table 2.64-1, entry 5.

ILHR 2.02 Handling, copying and miscellaneous fees.

(2) **PHOTOCOPYING FEES.** A photocopying fee of \$0.25 per page may be charged.

(3) **PLAN REPRODUCTION FEES.** A fee of \$5.00 per plan sheet shall be charged to the submitting party for plan reproduction on plan sheets larger than legal size. Plan sheets at or smaller than legal size may be charged the normal photocopying fee.

(4) **PLAN APPROVAL - ADDITIONAL COPIES.** (a) *Plumbing.* Upon request, additional copies of approved plumbing plans, with code violations cited and bearing the approval stamp, beyond the minimum amount required by administrative code or the department, shall be provided upon receipt of a \$10.00 fee, plus \$5.00 per plan sheet.

ILHR 2.61 Miscellaneous inspections, reviews and services.

(2) **REVISIONS.** The fee for revisions to previously approved plumbing and private sewage plans shall be \$60.00 per plan. This fee shall apply when plans are revised for reasons other than those which were requested by the department.

(3) **PRIORITY PLAN REVIEW.** An appointment may be made with the department to facilitate the examination of plans. The plans shall comply with the provisions of s. ILHR 82.20, for plumbing, and s. ILHR 83.08, for private sewage. Scheduling of the plans for priority plan review shall be determined in accordance with s. ILHR 82.20, for plumbing, and by appointment for private sewage. The fee for this type of plan examination shall be determined at twice the normal rate.

(4) **PROJECTS WITHOUT APPROVALS.** The fees specified in this subchapter shall be doubled for those projects for which the installation of plumbing has started without departmental approval.

(5) **MISCELLANEOUS SERVICES.** When the department provides goods or services not specifically covered in this section, fees may be charged to organizations requesting such goods and services.

A-82.30 (4) The following tables lists the maximum GPM which can be expected to readily flow through a given size trap where the receptor has a height as indicated.

Also listed is a maximum drainage fixture unit load which a given size receptor trap may be expected to adequately receive.

Note: The department recommends an individual 4-inch diameter minimum trap and drain pipe for a commercial type dishwasher.

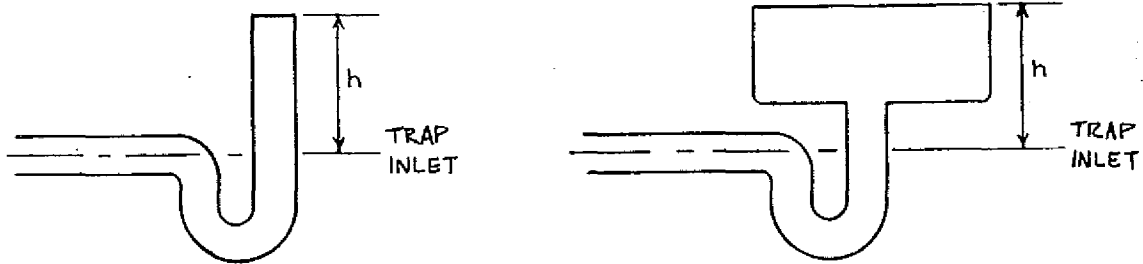

| Receptor Trap size | H Height | GPM | d.f.u. |
|--------------------|----------|-----|--------|
| 1-1/2" | 12" | 4 | 2 |
| 2" | 14" | 8 | 4 |
| 3" | 15" | 12 | 6 |
| 4" | 17" | 40 | 20 |
| 5" | 20" | 70 | 35 |
| 6" | 22" | 120 | 60 |
| 8" | 25" | 250 | 125 |

ILHR 82 Appendix

A-82.30 (6) (b) OFFSETS IN VERTICAL DRAINS.

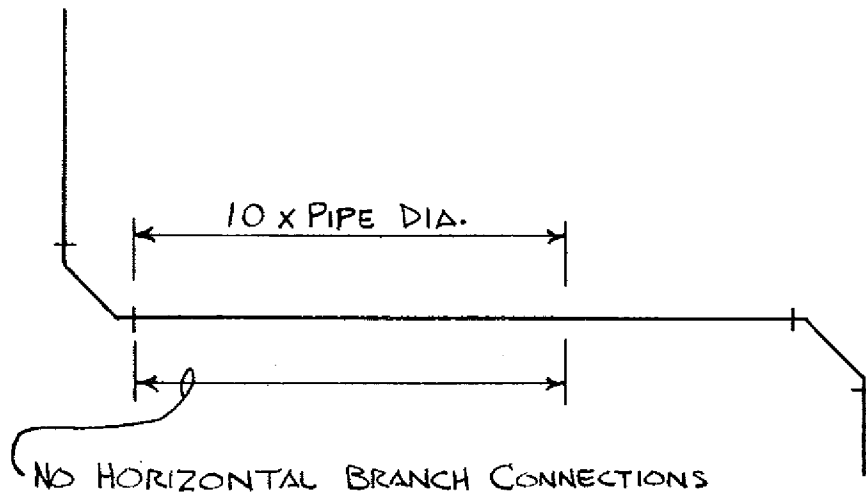
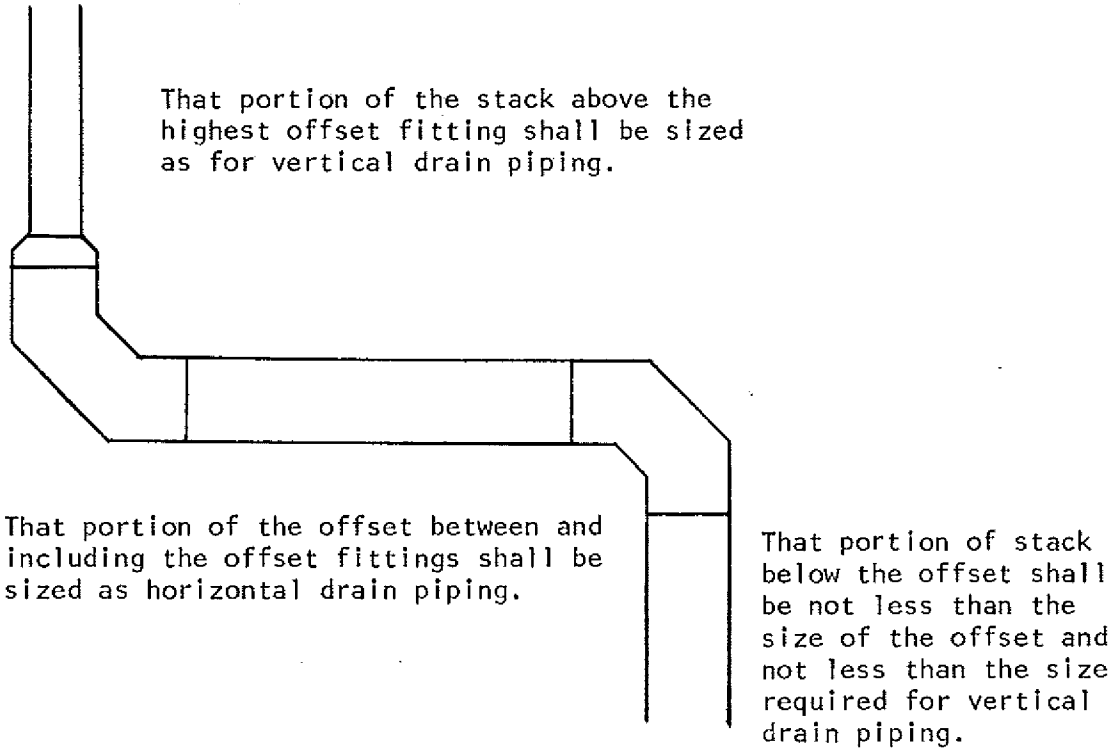

A-82.30 (7) HORIZONTAL BRANCH DRAIN CONNECTION AT BASE OF A STACK.

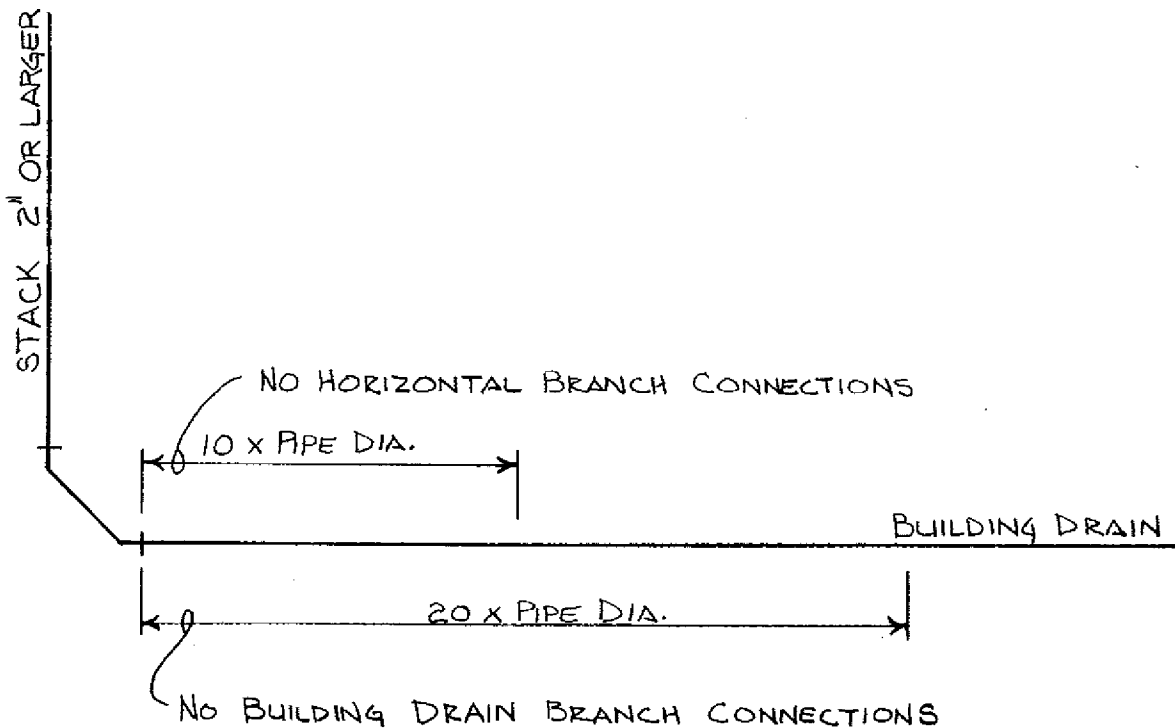

A-82.30 (8) MEASURING RADIUS OF A FITTING.

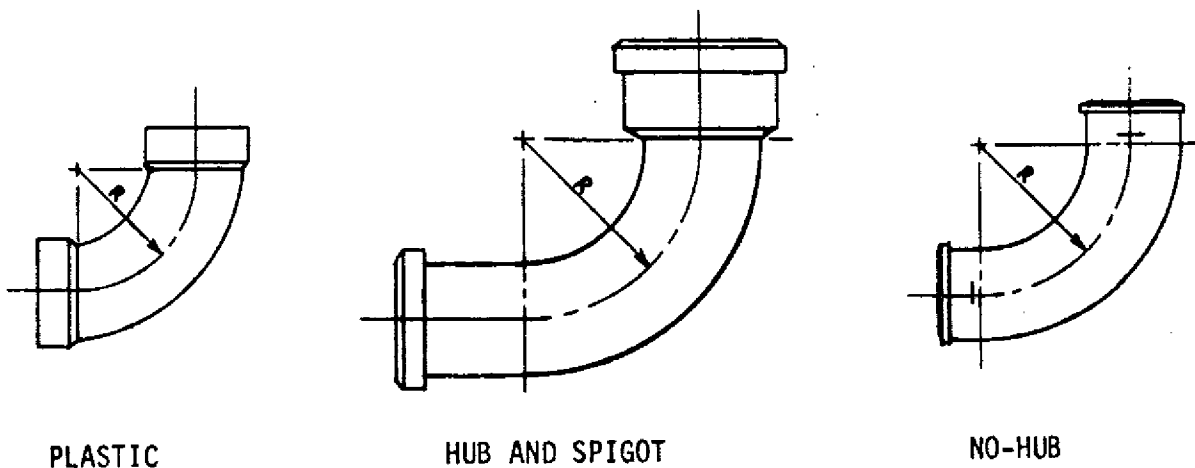

A-82.30 (9) DRAIN FITTINGS AND CONNECTIONS.

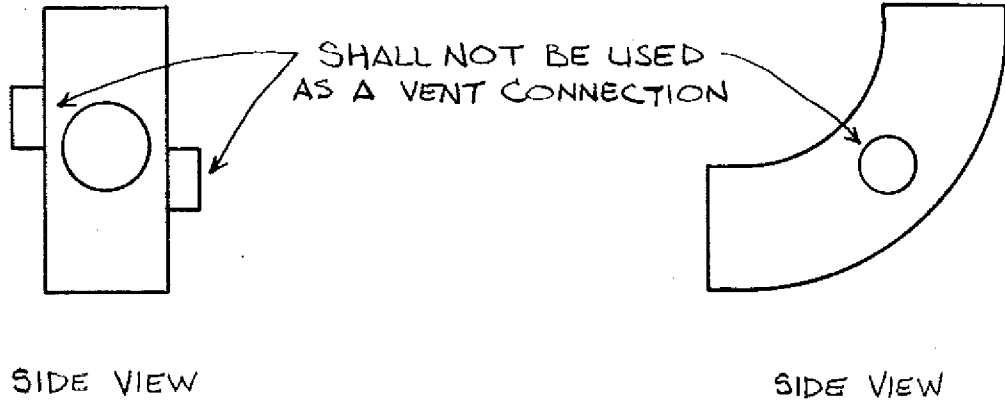

SIDE INLETS

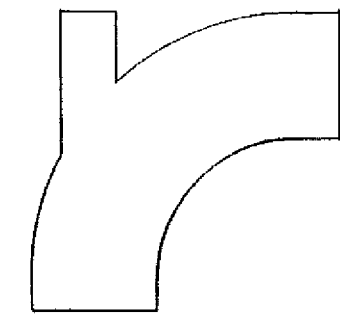

ALLOWED
(SIDE VIEW)

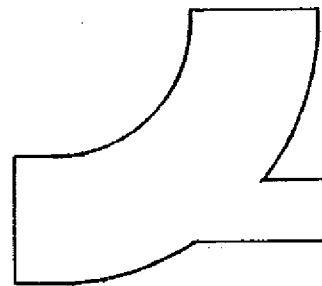

NOT ALLOWED
(TOP VIEW OR SIDE VIEW)

HEEL INLETS

A-82.30 (10) (a) DETERMINING REQUIRED CAPACITY OF SANITARY SUMP.

SANITARY SUMP

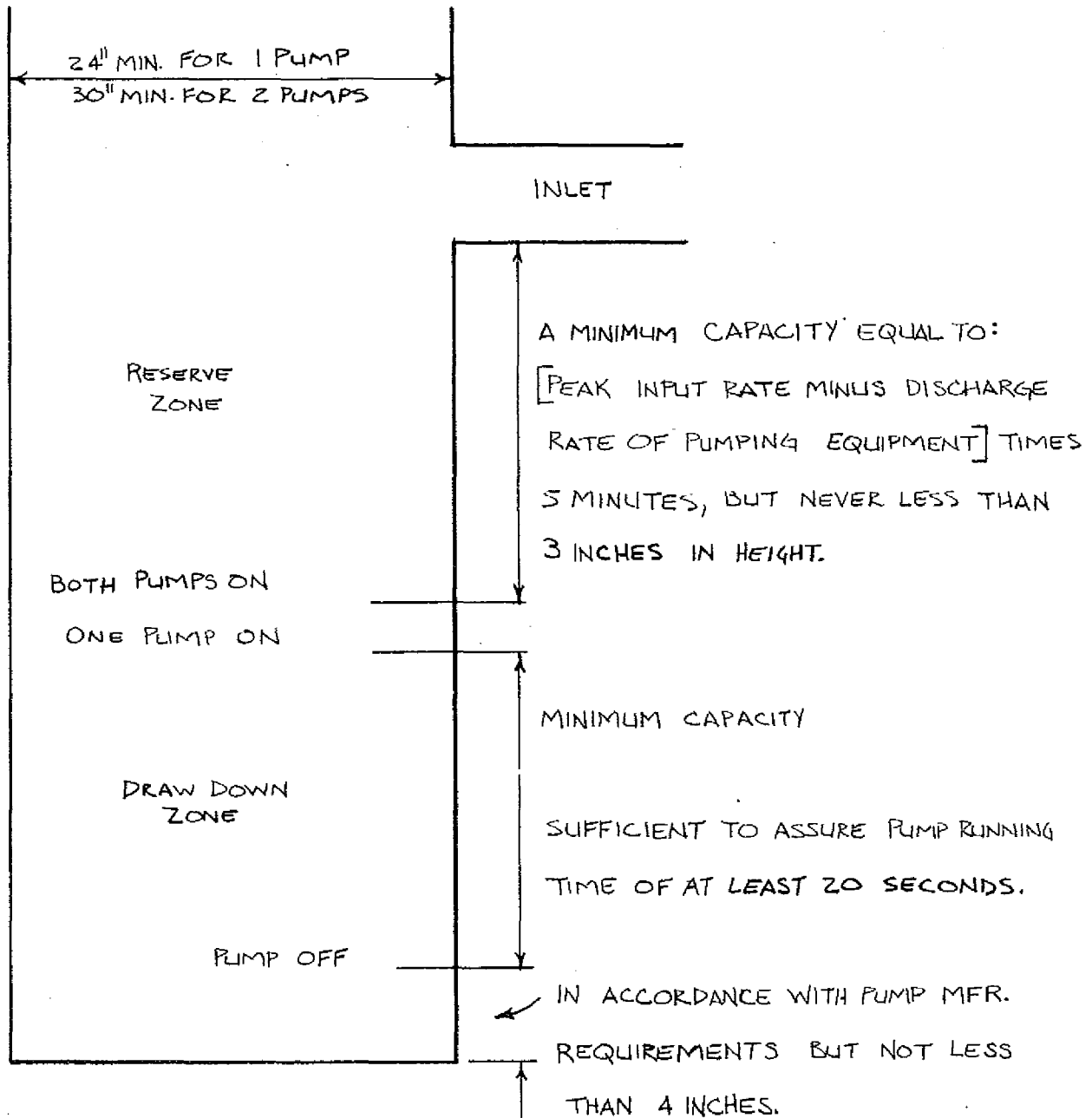

ILHR 82 Appendix

A-82.30 (10) (a)

Capacity of Sumps
(in gallons)

| Diameter of sump in inches | Volume in gal/ft | Diameter of sump in inches | Volume in gal/ft |
|----------------------------|------------------|----------------------------|------------------|
| 24 | 23.5 | 41 | 68.6 |
| 25 | 25.5 | 42 | 72.1 |
| 26 | 27.6 | 43 | 75.5 |
| 27 | 29.7 | 44 | 79.1 |
| 28 | 32.0 | 45 | 82.7 |
| 29 | 34.3 | 46 | 86.5 |
| 30 | 36.8 | 47 | 90.2 |
| 31 | 39.2 | 48 | 94.0 |
| 32 | 41.8 | 54 | 119.0 |
| 33 | 44.5 | 60 | 147.0 |
| 34 | 47.2 | 66 | 178.0 |
| 35 | 50.0 | 72 | 211.5 |
| 36 | 52.8 | 78 | 248.4 |
| 37 | 55.9 | 84 | 288.1 |
| 38 | 59.0 | 90 | 330.8 |
| 39 | 62.1 | 96 | 376.3 |
| 40 | 65.3 | 108 | 477.3 |

A-82.30 (11) (b) BUILDING DRAINS SERVING ANY BUILDING.

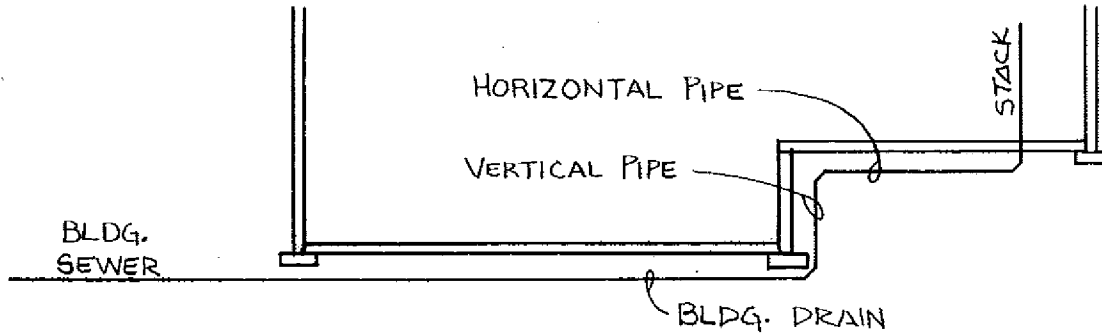
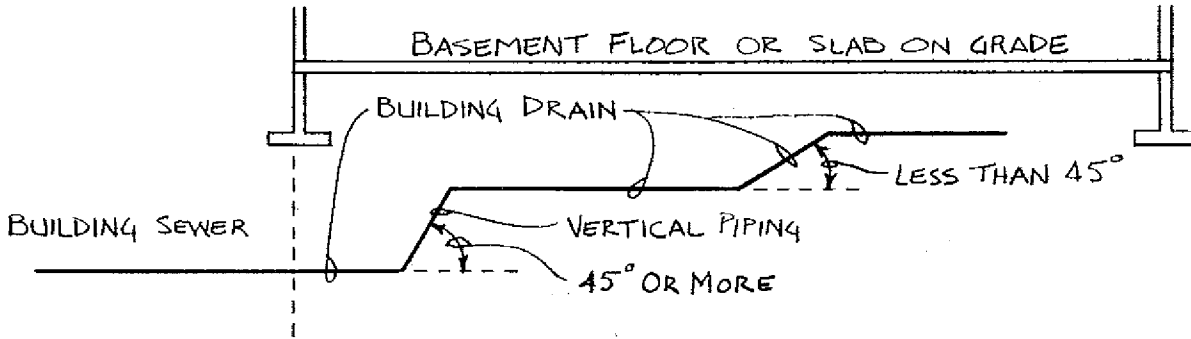

A-82.30 (11) (b) BUILDING DRAINS SERVING DWELLING UNITS.

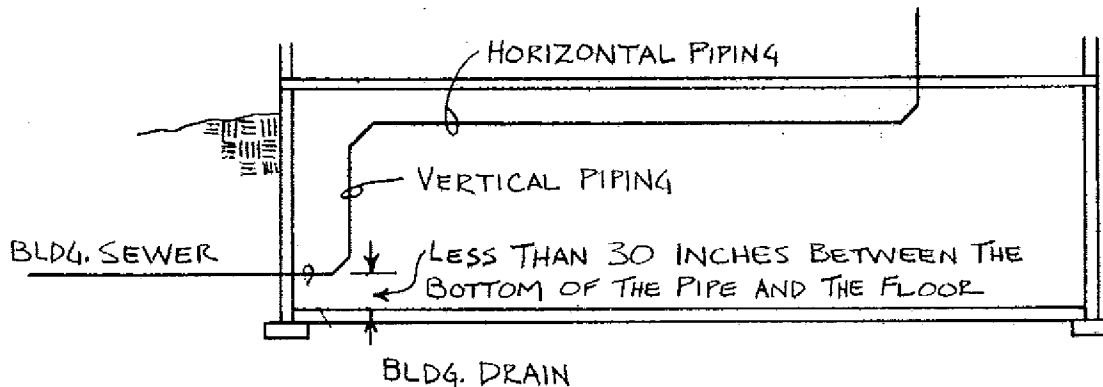
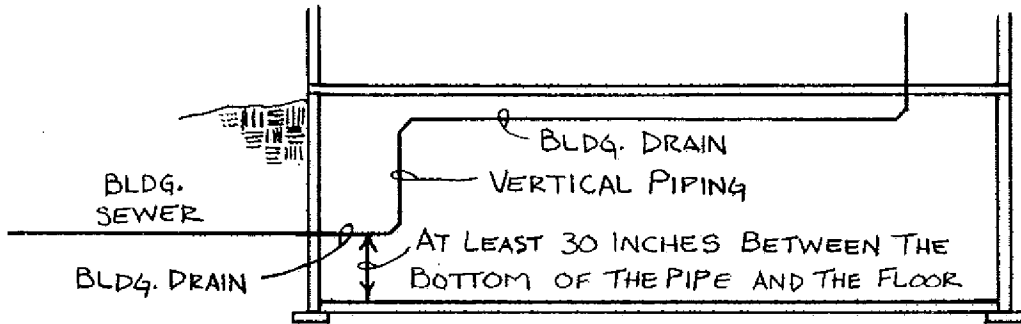

ILHR 82 Appendix

A-82.30 (11) (b) FLOOR DRAIN REQUIRED.

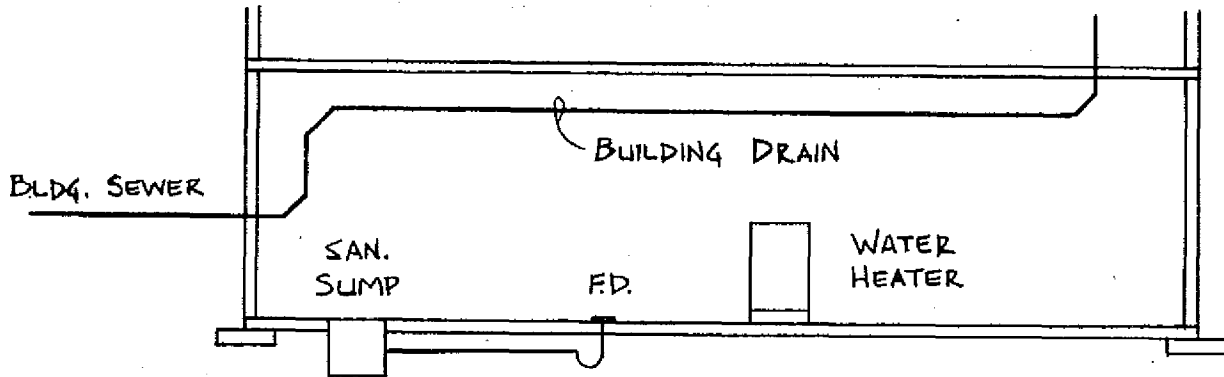

A-82.30 (11) (f) CONNECTION TO PRESSURIZED PUBLIC SEWER.

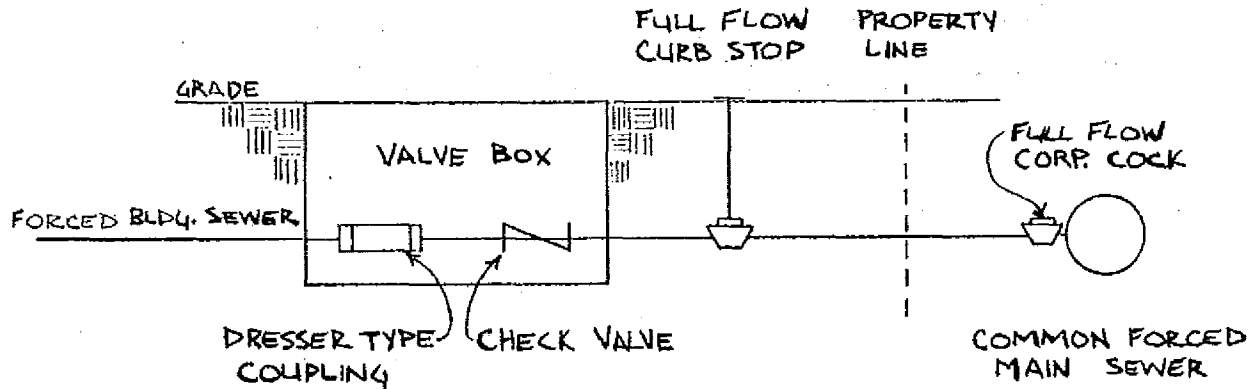

A-82.31 (4) (a) WHERE A VENT STACK AND STACK VENT ARE REQUIRED.

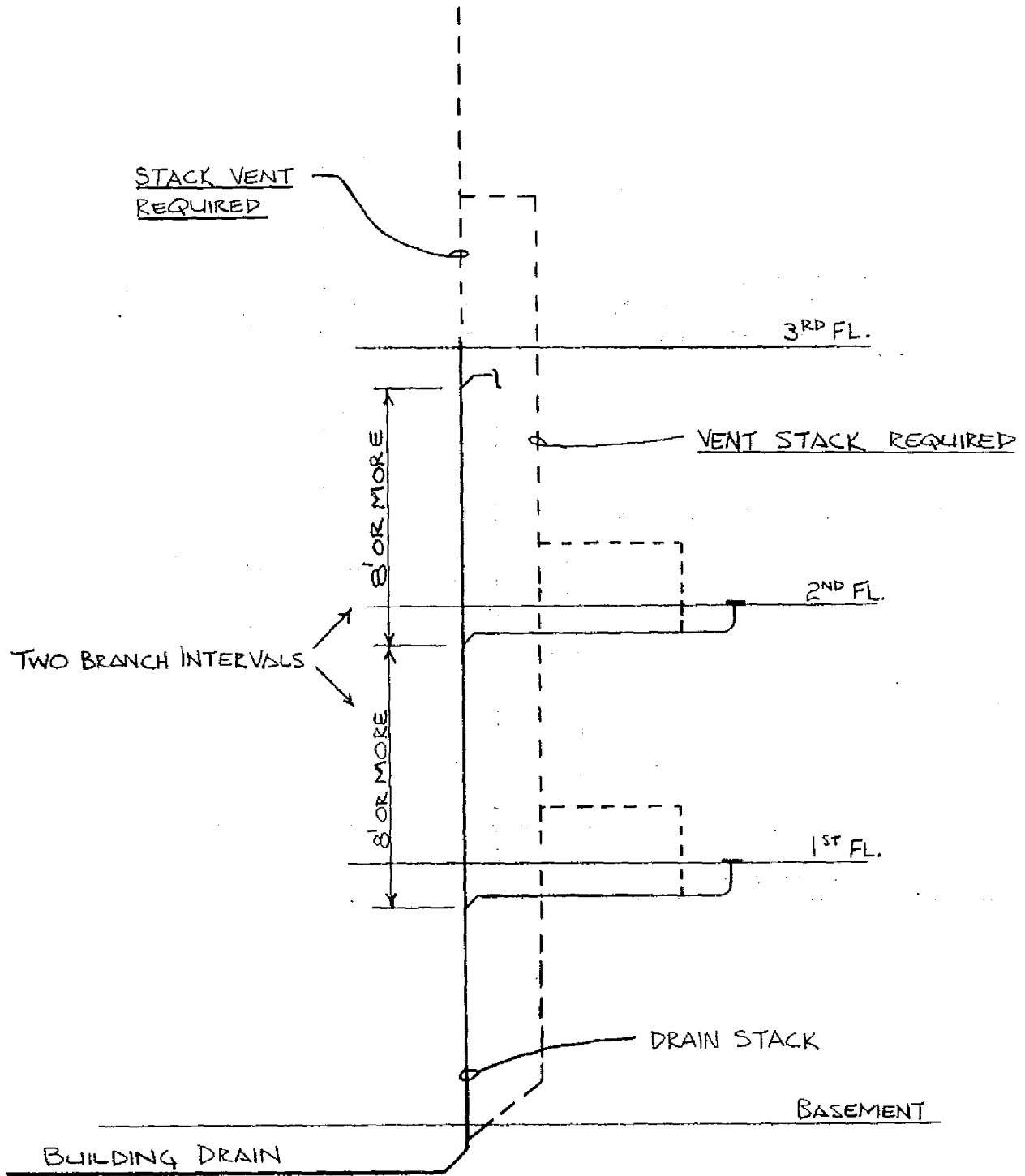

ILHR 82 Appendix

A-82.31 (4) (a) WHERE A VENT STACK AND STACK VENT ARE NOT REQUIRED.

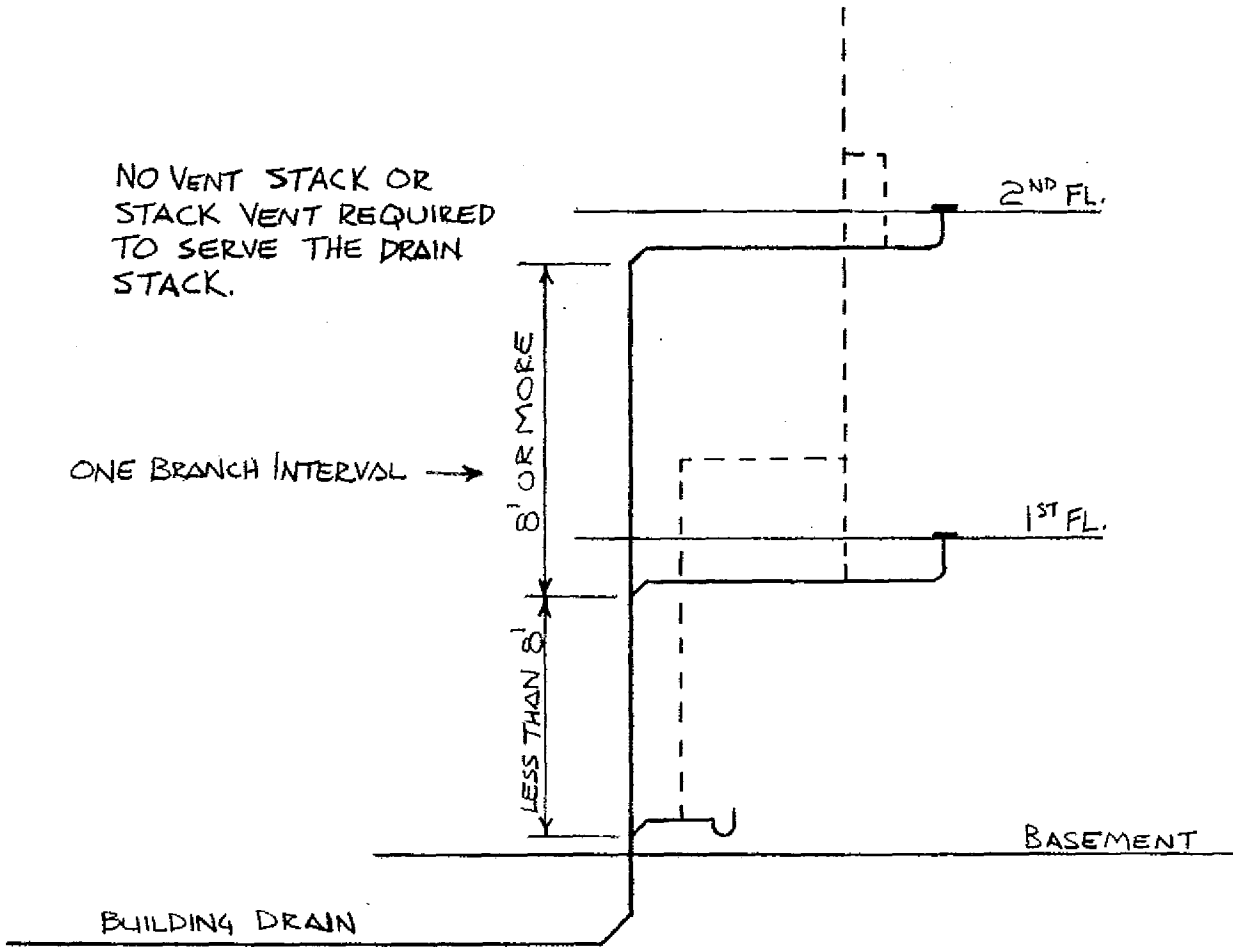

A-82.31 (4) (b) INSTALLATION OF VENT STACK AND STACK VENT.

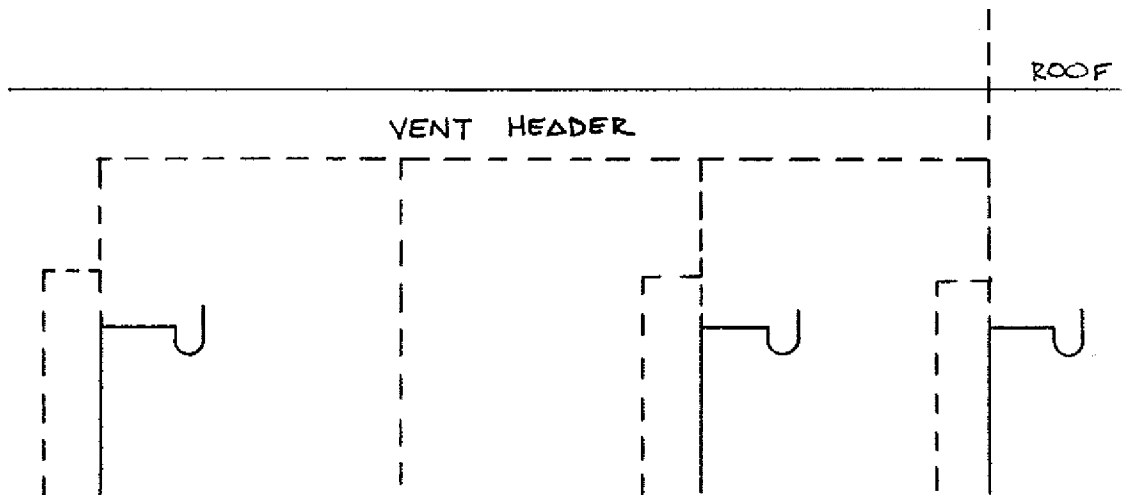
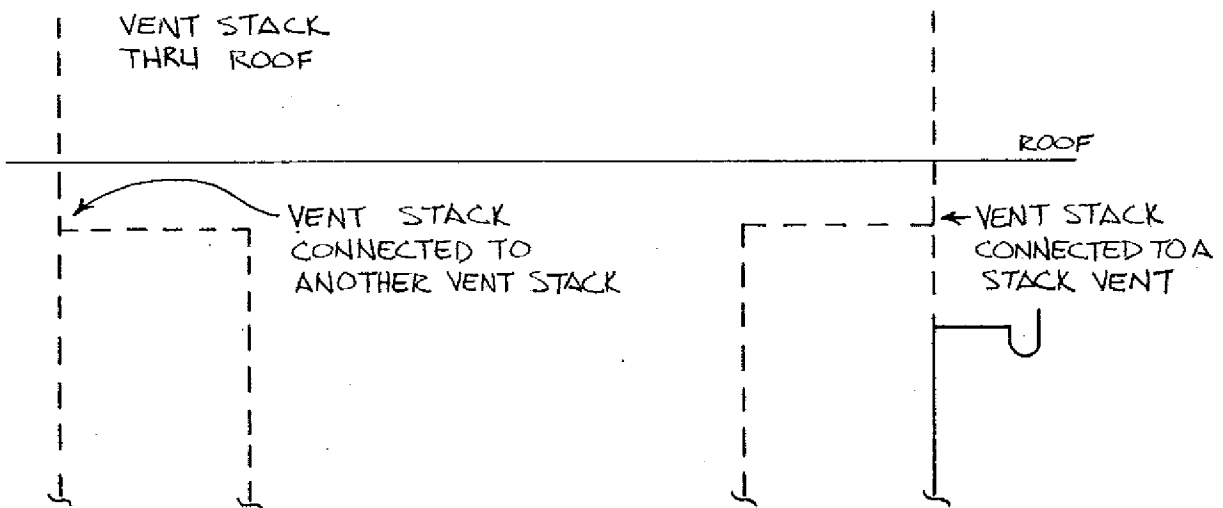
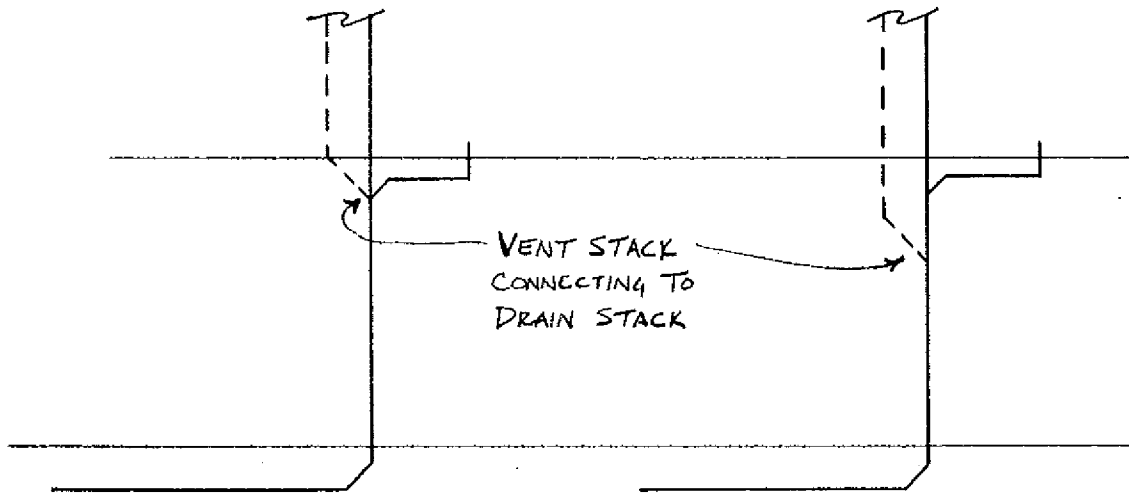

ILHR 82 Appendix

A-82.31 (5) (a) RELIEF VENT FOR OFFSETS OF 30 TO 45 DEGREES.

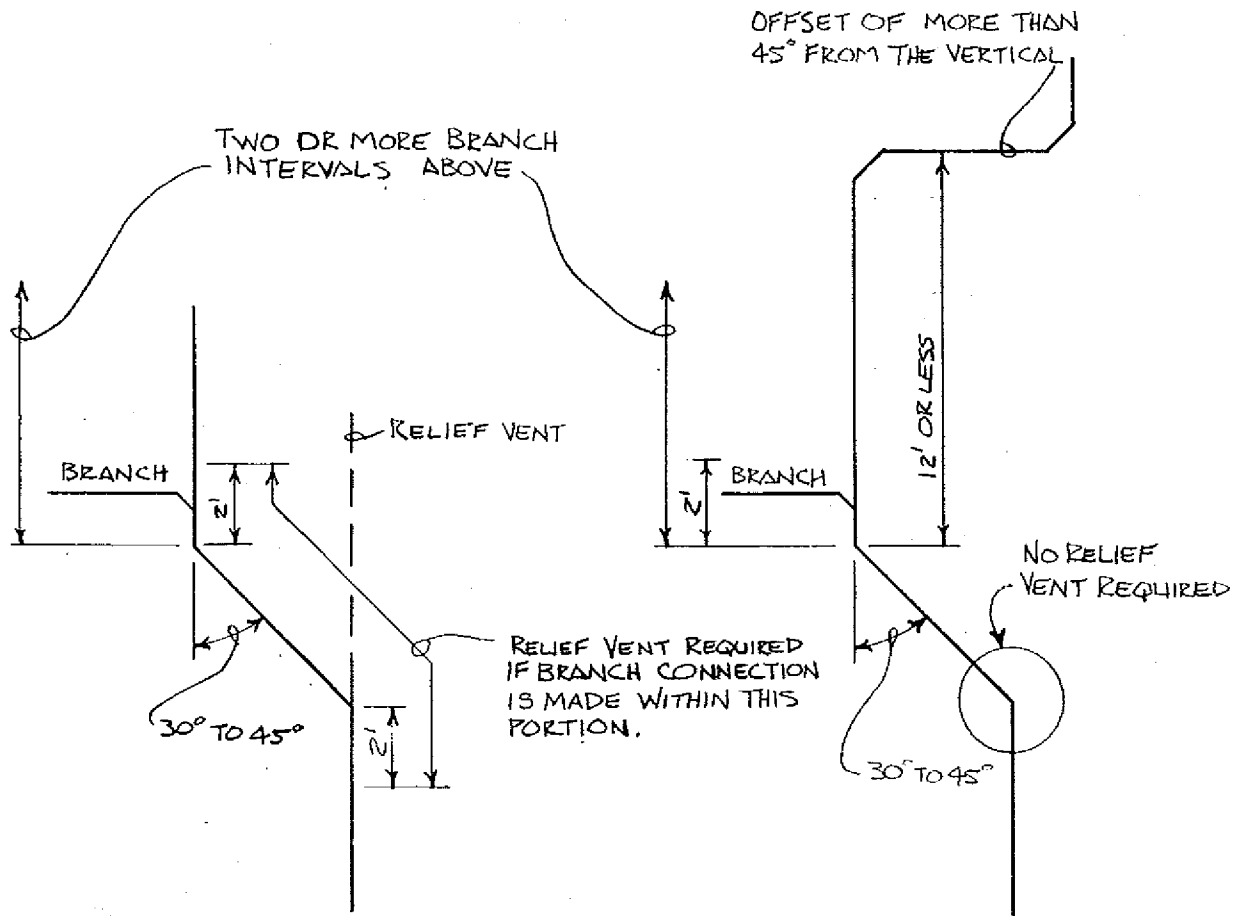

A-82.31 (5) (b) RELIEF AND YOKE VENTS FOR OFFSETS OF MORE THAN 45 DEGREES.

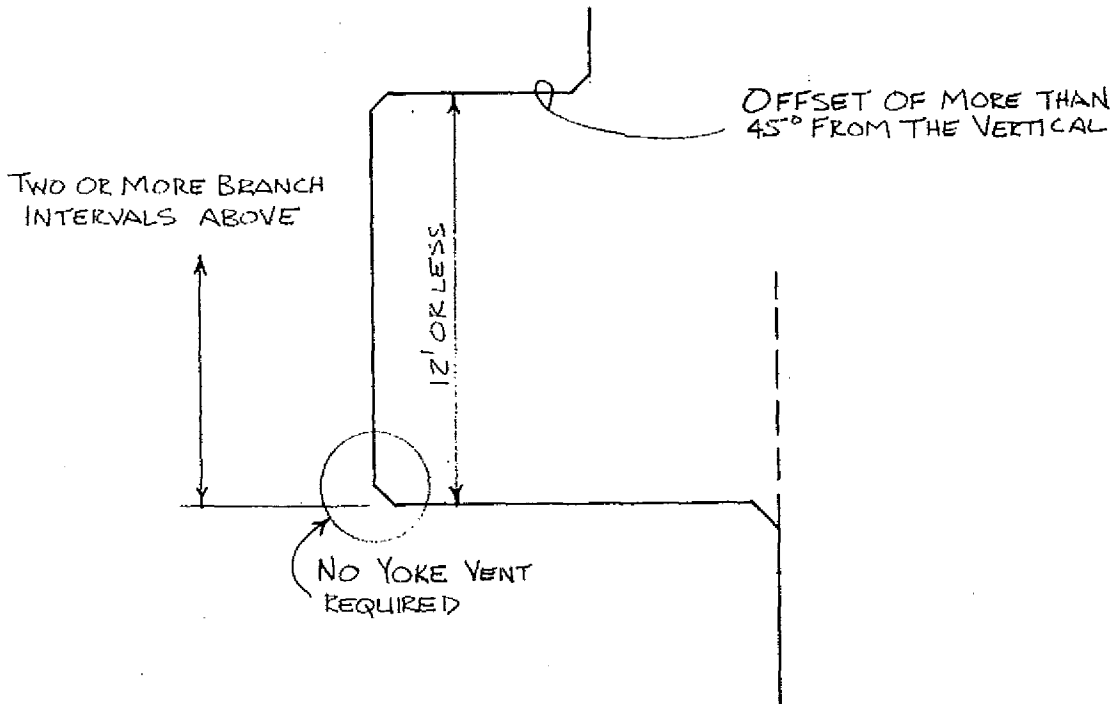
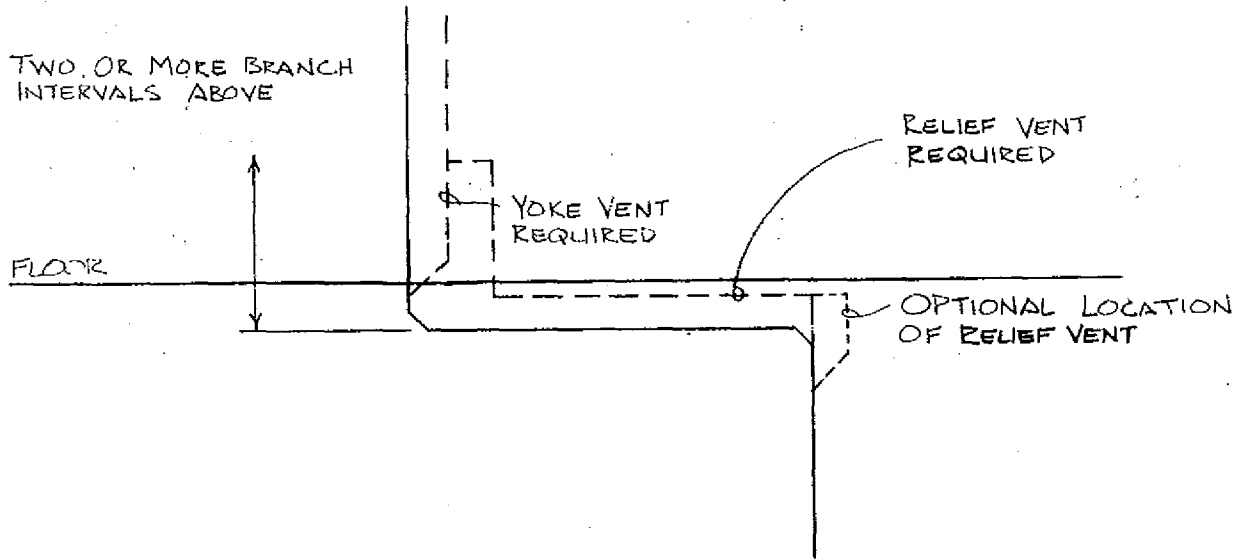

ILHR 82 Appendix

A-82.31 (7) RELIEF VENTS FOR BUILDING DRAINS.

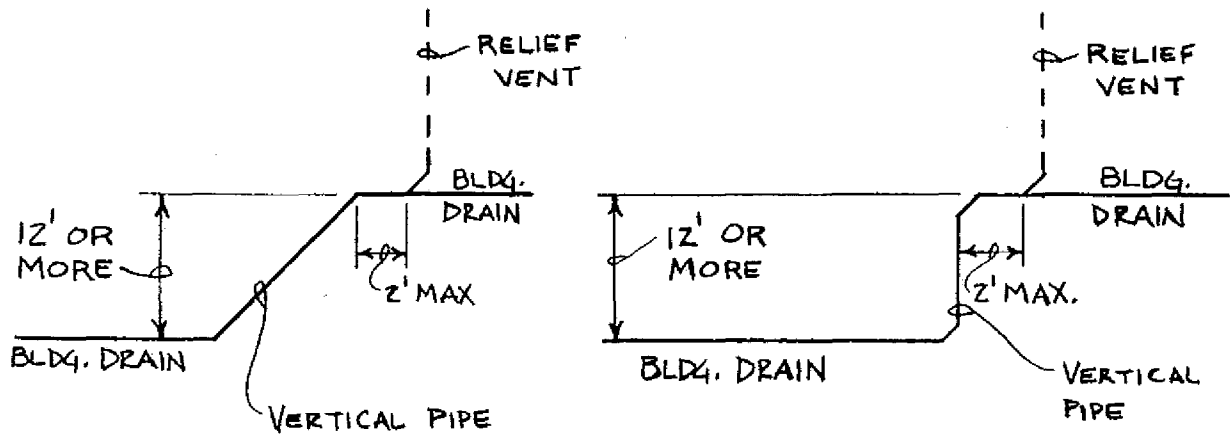

A-82.31 (9) FIXTURE VENTS.

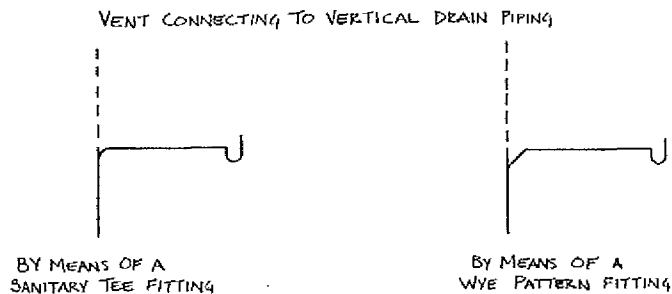
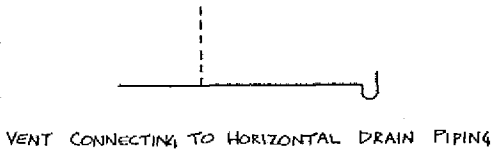
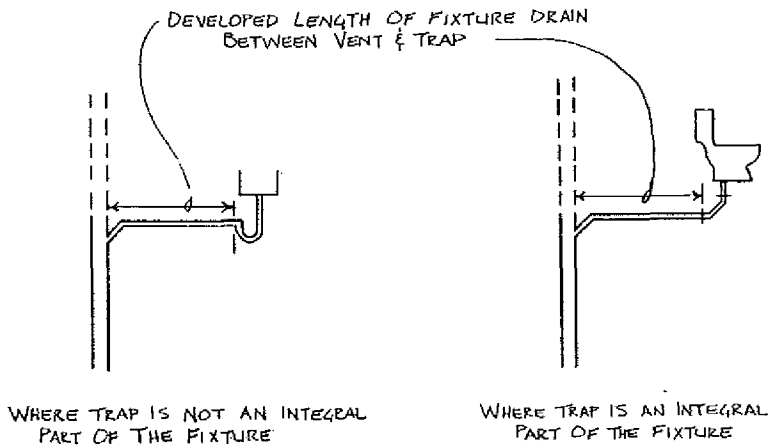

A-82.31 (10) CIRCUIT VENTING.

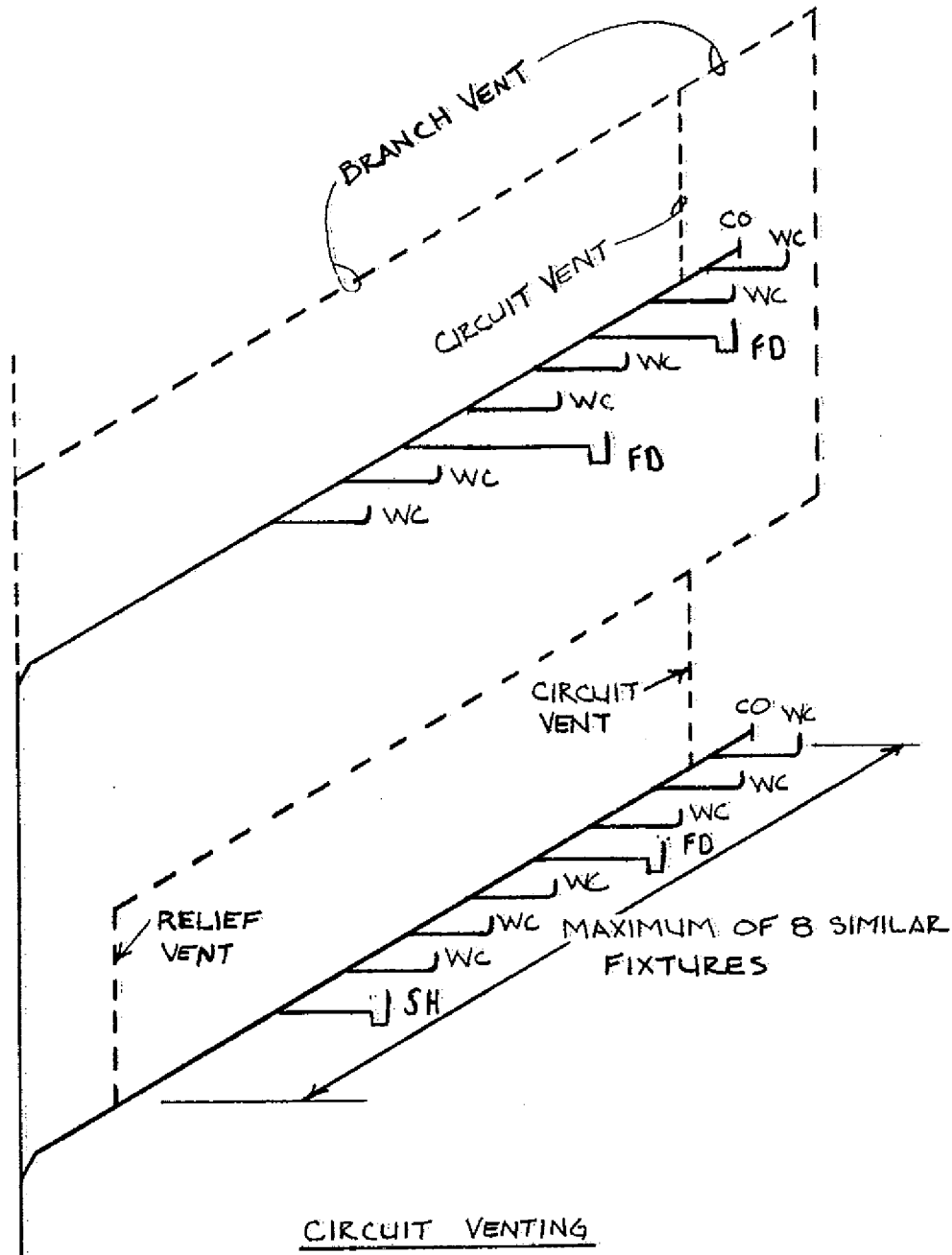

ILHR 82 Appendix

A-82.31 (10) CIRCUIT VENTING.

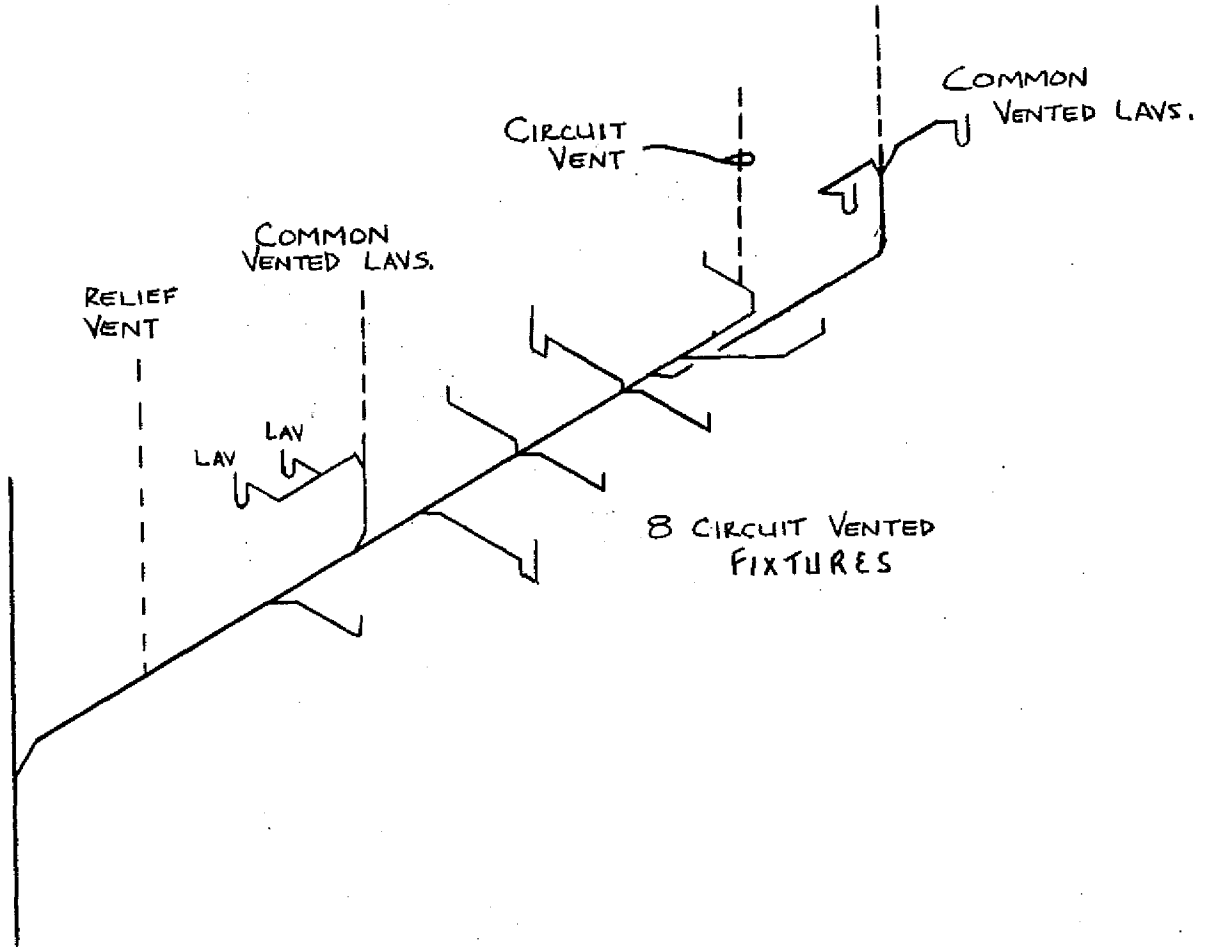

A-82.31 (10) CIRCUIT VENTING.

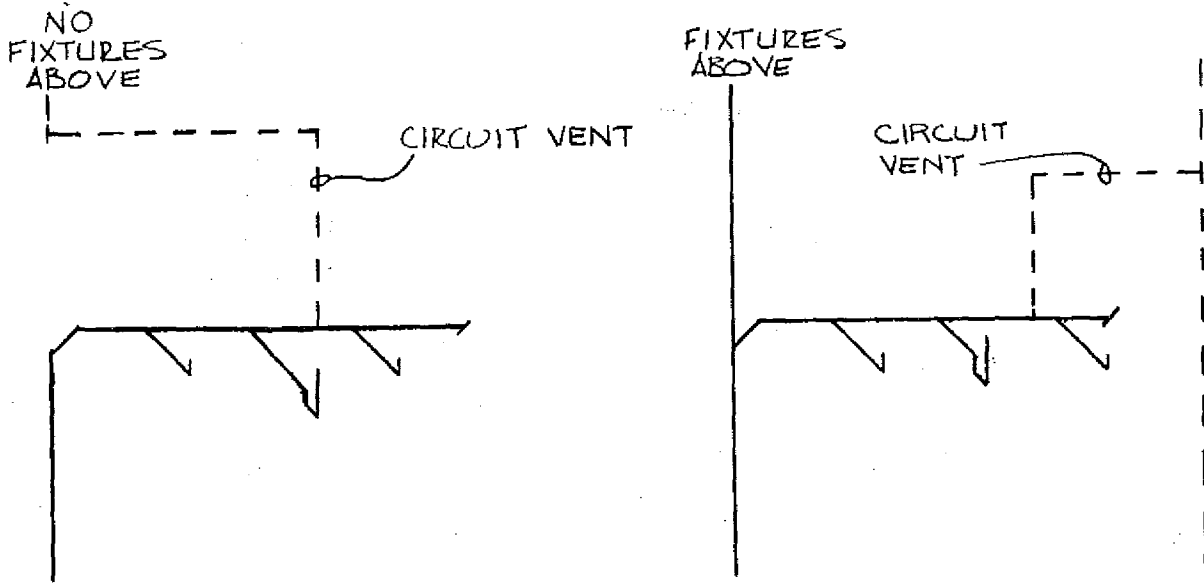

CIRCUIT VENTING
3 FIXTURES

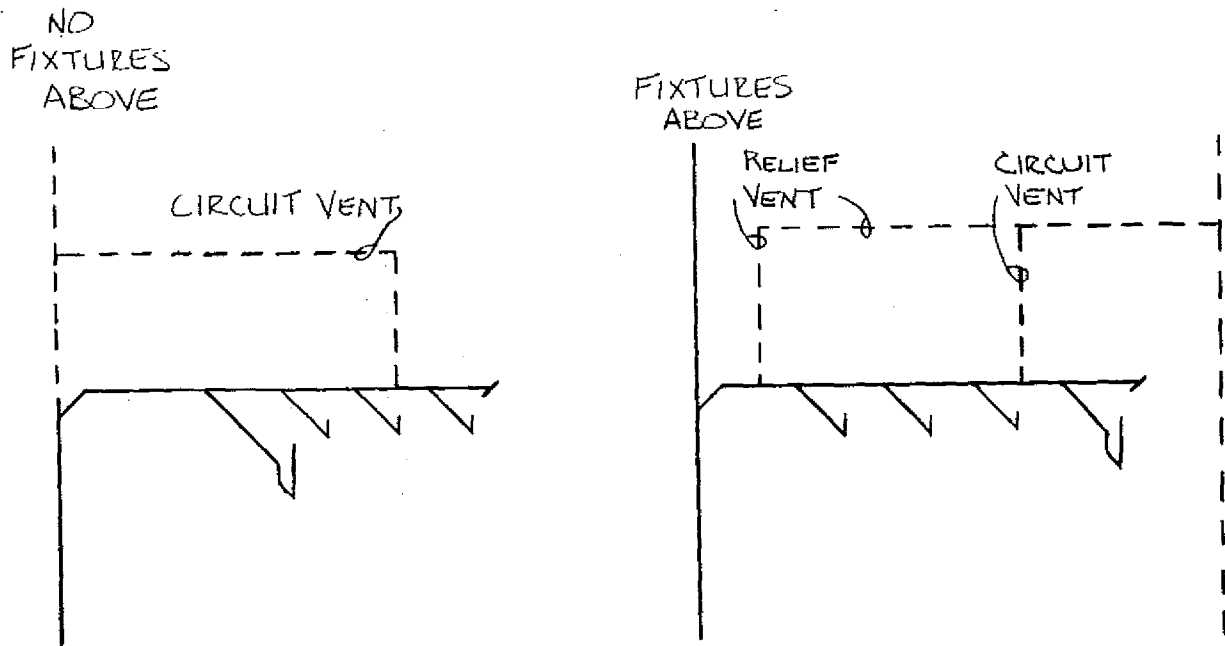

CIRCUIT VENTING 4 OR
MORE FIXTURES

ILHR 82 Appendix

A-82.31 (10) CIRCUIT VENTING.

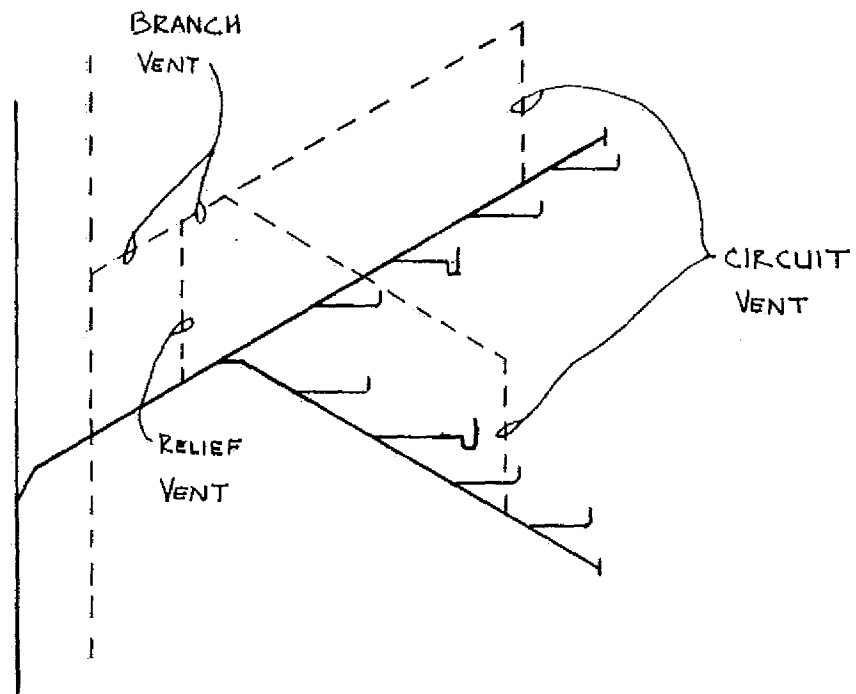
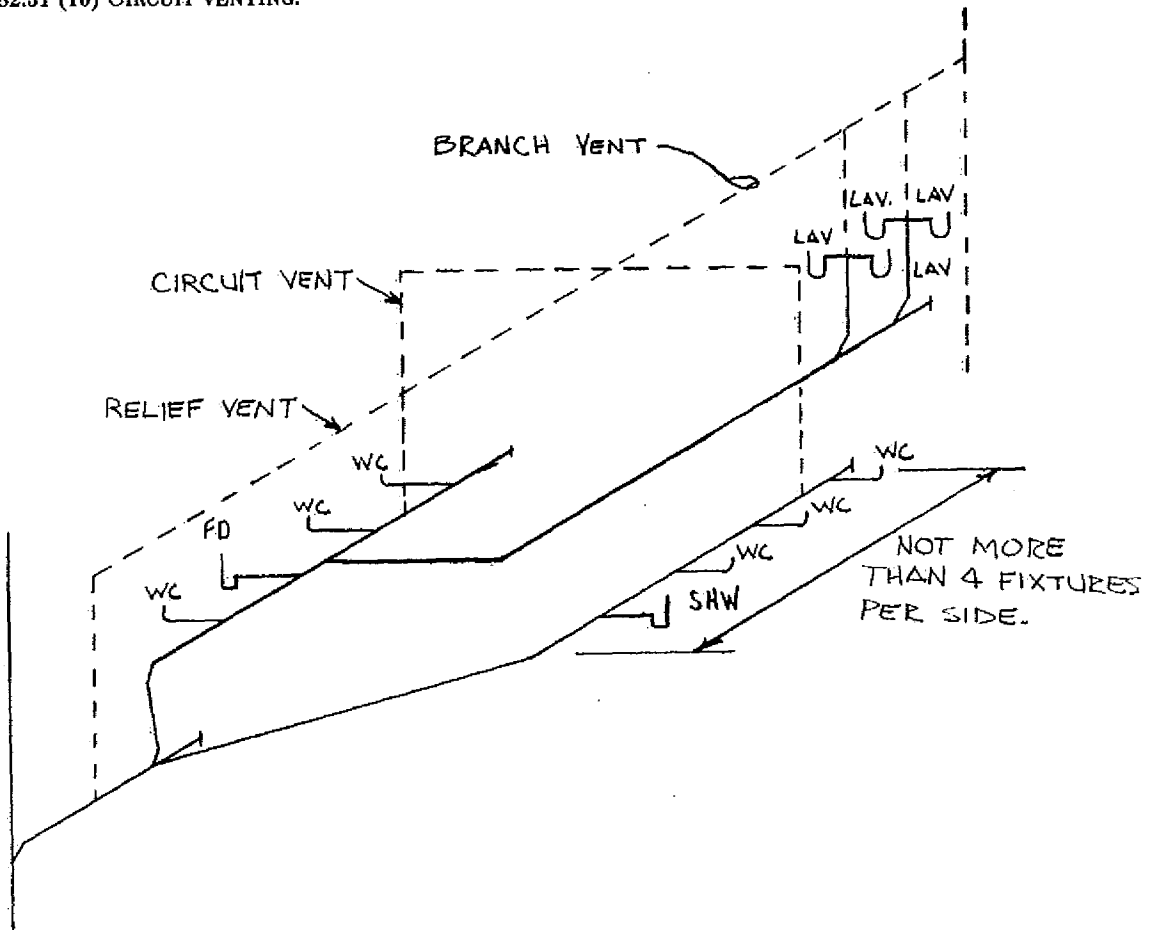

A-82.31 (11) (a) COMMON VENTS, VERTICAL DRAINS.

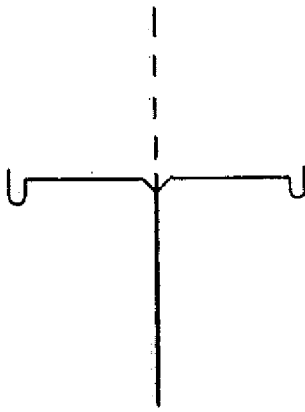

BACK-TO-BACK

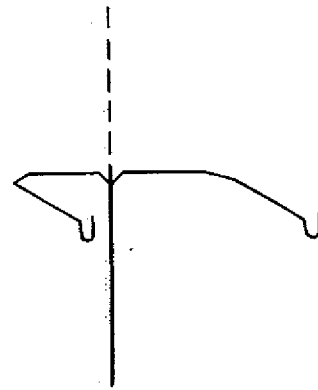

SIDE-BY-SIDE

COMMON VENT SERVING ANY TWO FIXTURES

A-82.31 (11) (b) COMMON VENTS, HORIZONTAL DRAINS.

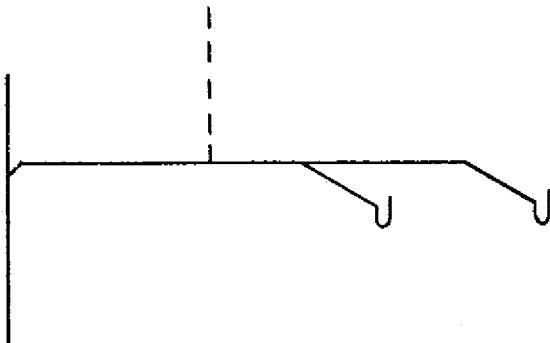
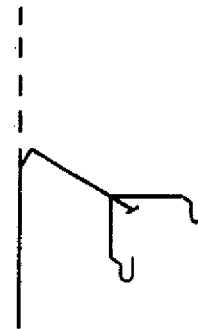
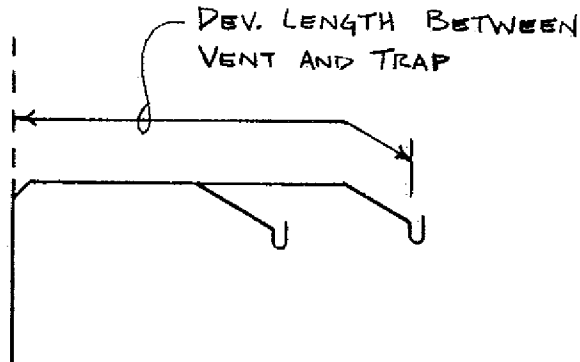

COMMON VENTS SERVING TWO LAVATORIES OR
TWO COMPARTMENTS OF ONE KITCHEN SINK

ILHR 82 Appendix

A-82.31 (12) ISLAND FIXTURE VENTING.

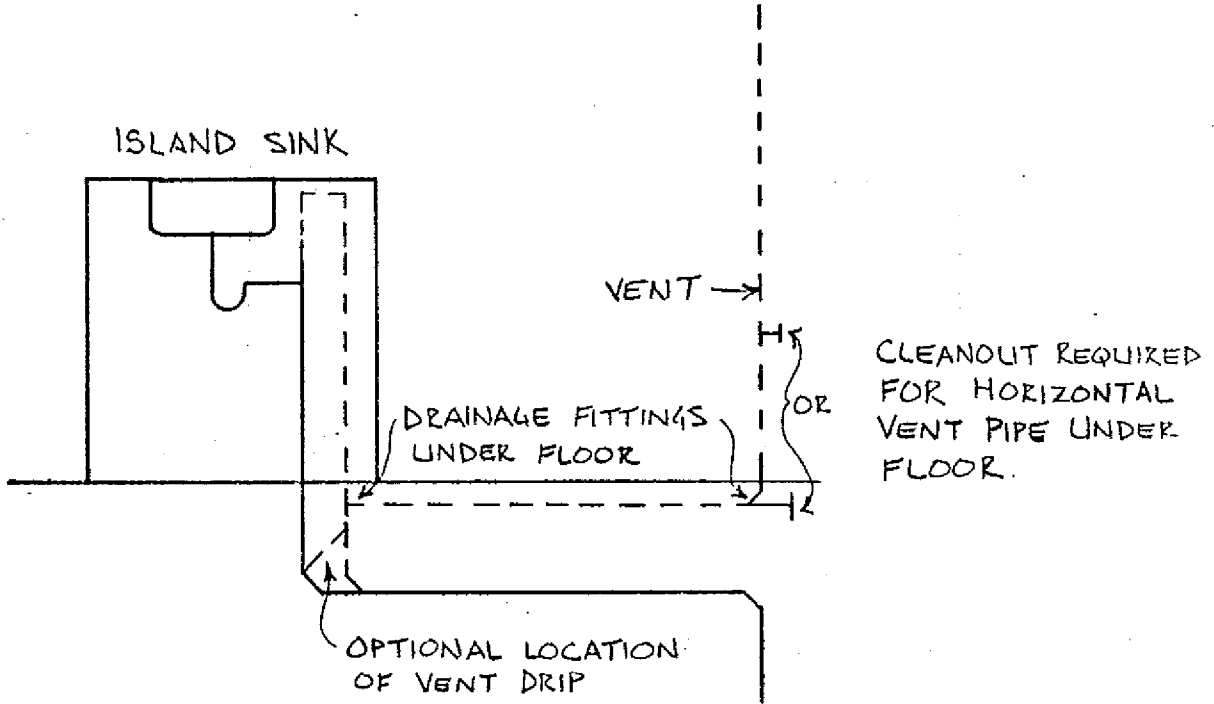

A-82.31 (13) (a) VERTICAL WET VENTS.

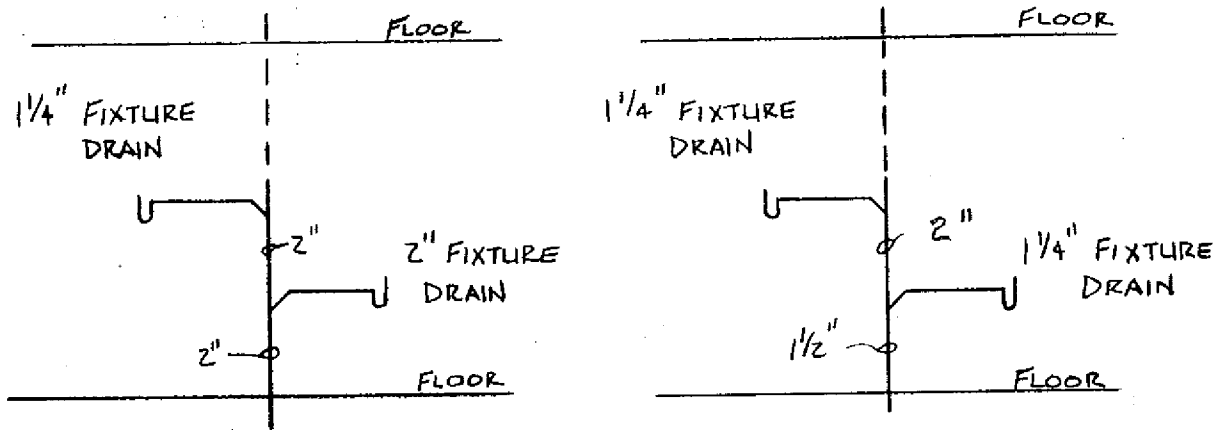

VERTICAL WET VENT

A-82.31 (13) (b) HORIZONTAL WET VENTS.

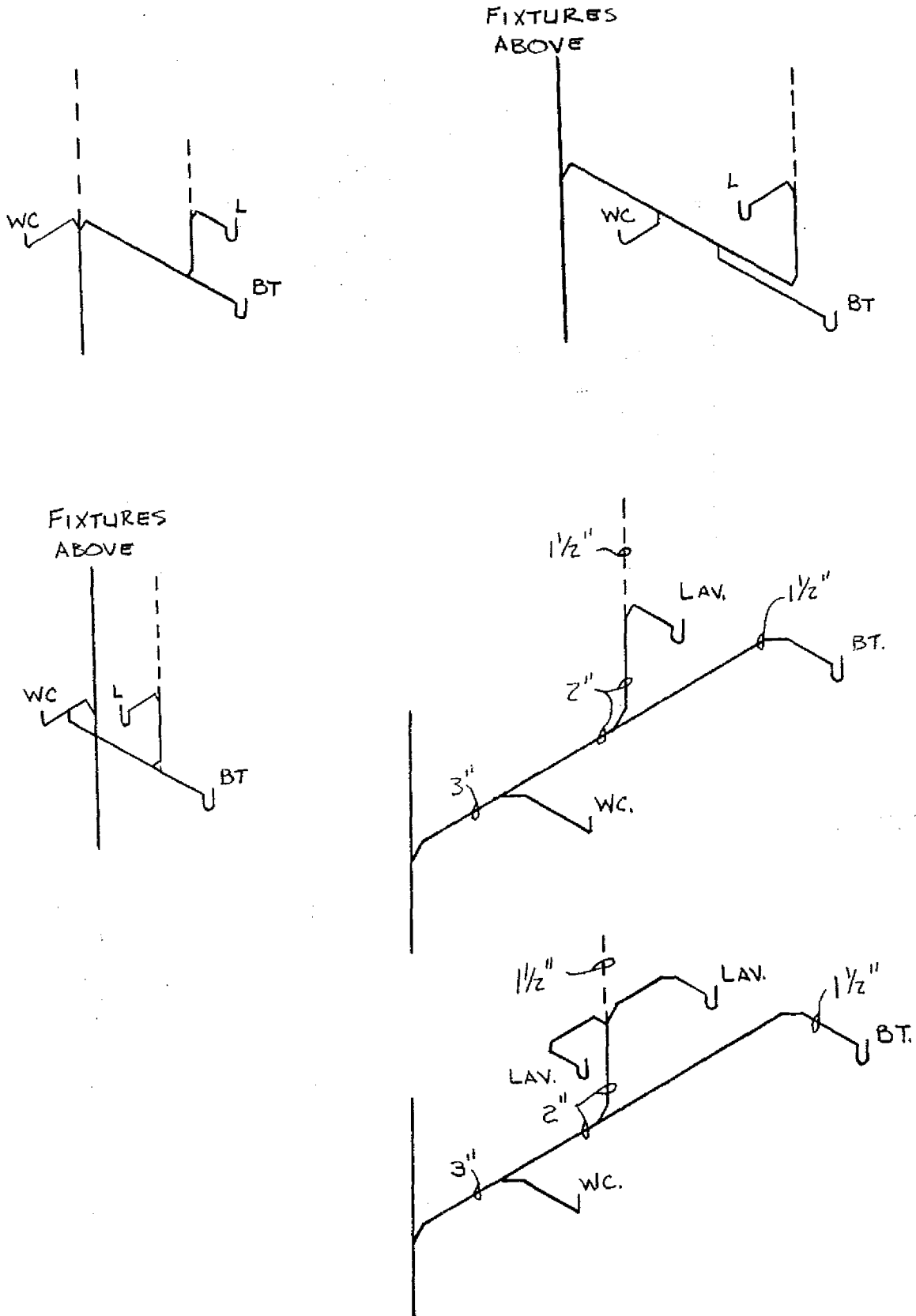

ILHR 82 Appendix

A-82.31 (13) (b) HORIZONTAL WET VENTS.

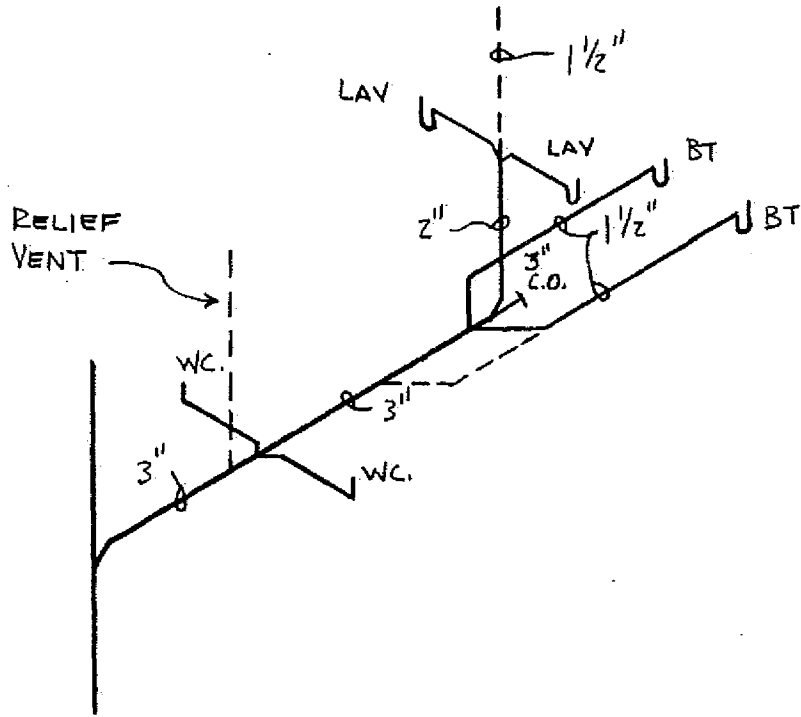

HORIZONTAL WET VENTS

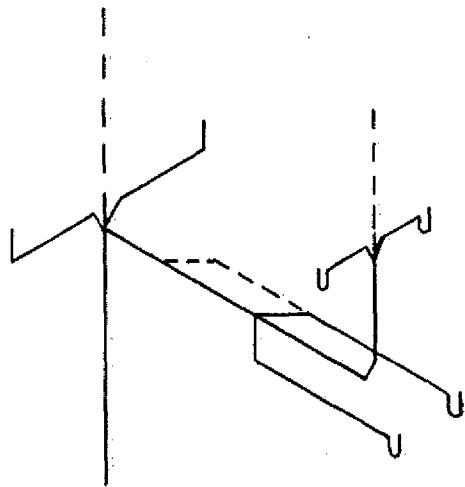

BACK-TO-BACK TOP FLOOR

A-82.31 (13) (c) WET VENTING - FLOOR OUTLET FIXTURES.

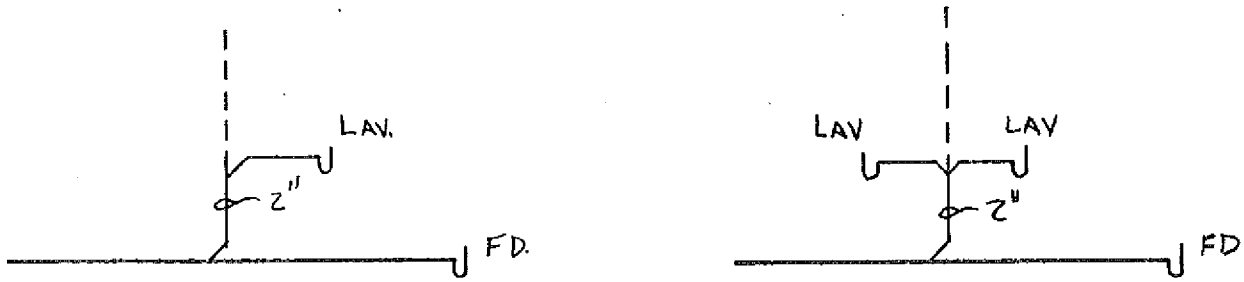

INDIVIDUAL VENT FOR FLOOR OUTLET FIXTURE
SERVING AS A WET VENT

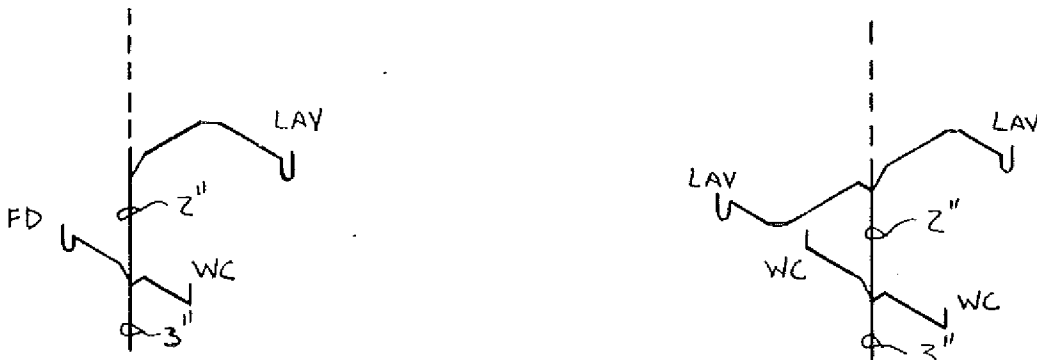

COMMON VENT FOR FLOOR OUTLET FIXTURES
SERVING AS A WET VENT

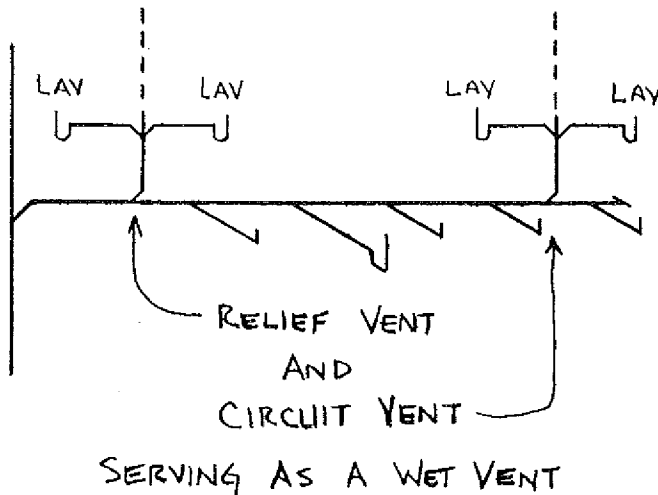

ILHR 82 Appendix

A-82.31 (14) (a) and (b) SIZING VENT STACKS AND STACK VENTS.

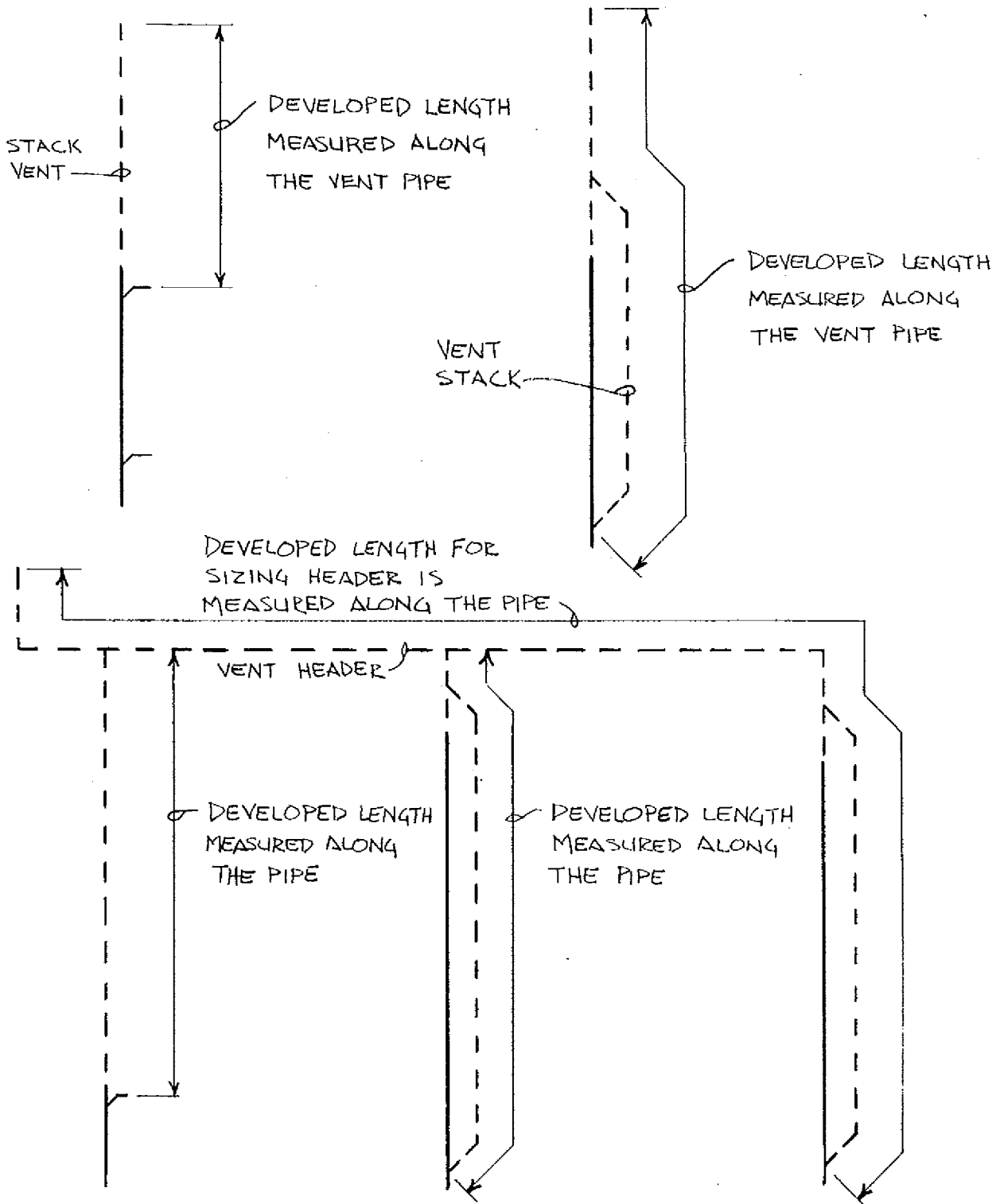

A-82.31 (14) (c) SIZING BRANCH VENTS.

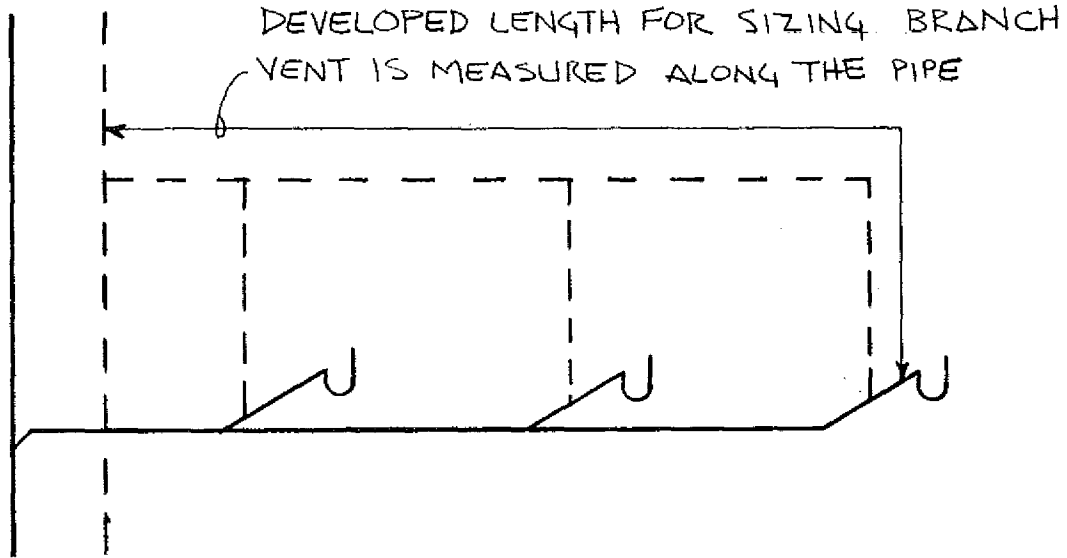

A-82.31 (14) (d) SIZING INDIVIDUAL VENTS.

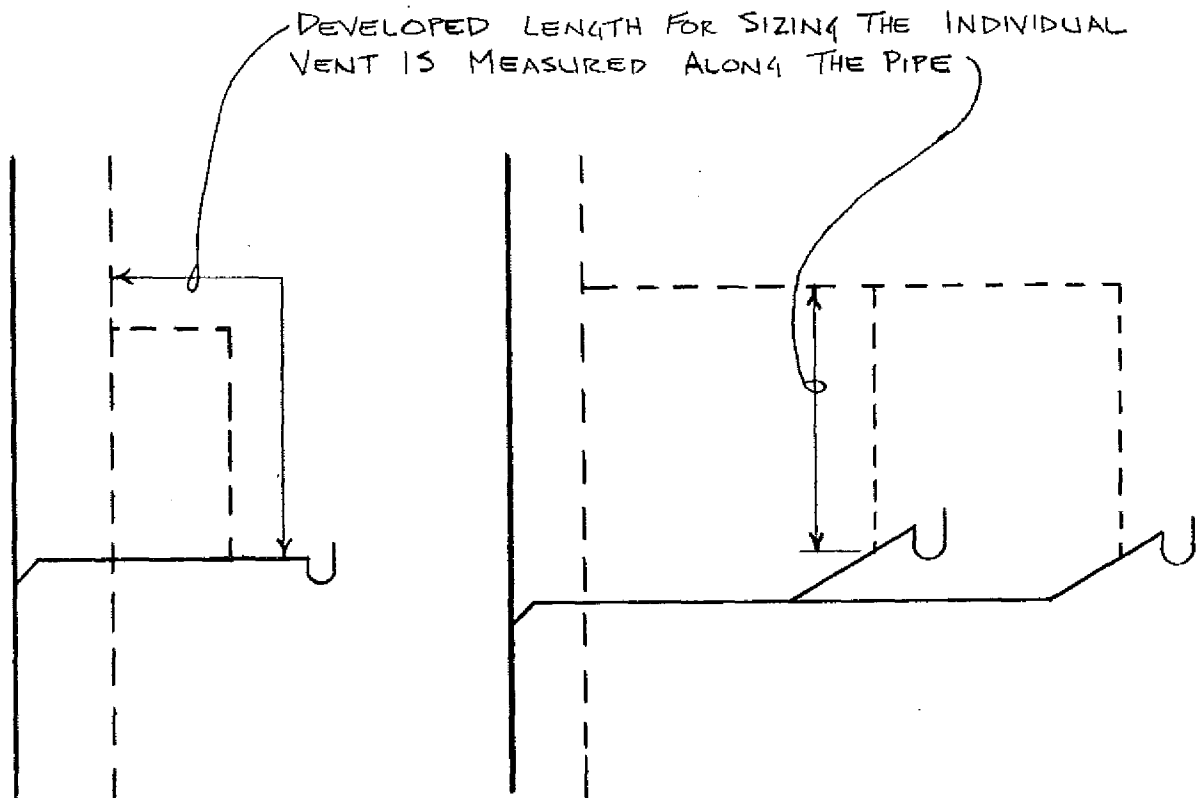

A-82.31 (14) (c) SIZING BRANCH VENTS SERVING A WET VENT.

WHEN SIZING THE BRANCH VENT, THE DEVELOPED LENGTH IS MEASURED ALONG THE VENT PIPE, INCLUDING THE WET VENT PORTION.

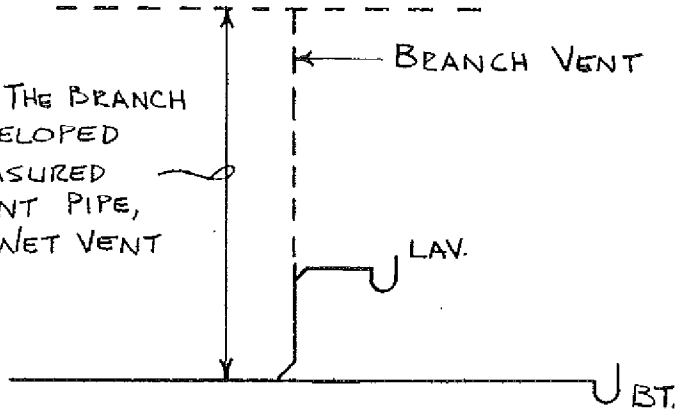

WHEN SIZING THE BRANCH VENT, THE DEVELOPED LENGTH IS MEASURED ALONG THE VENT PIPE, INCLUDING THE WET VENT PORTION.

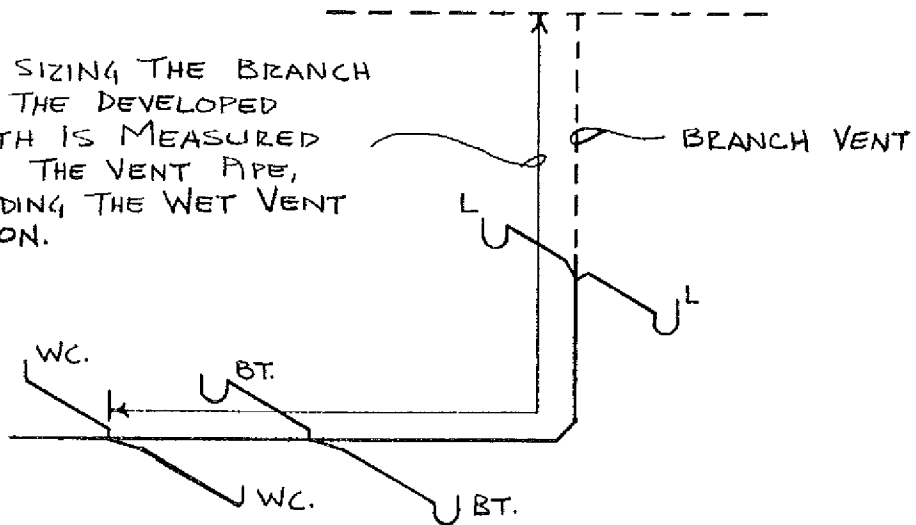

A-82.31 (15) (a) VENT GRADES AND CONNECTIONS.

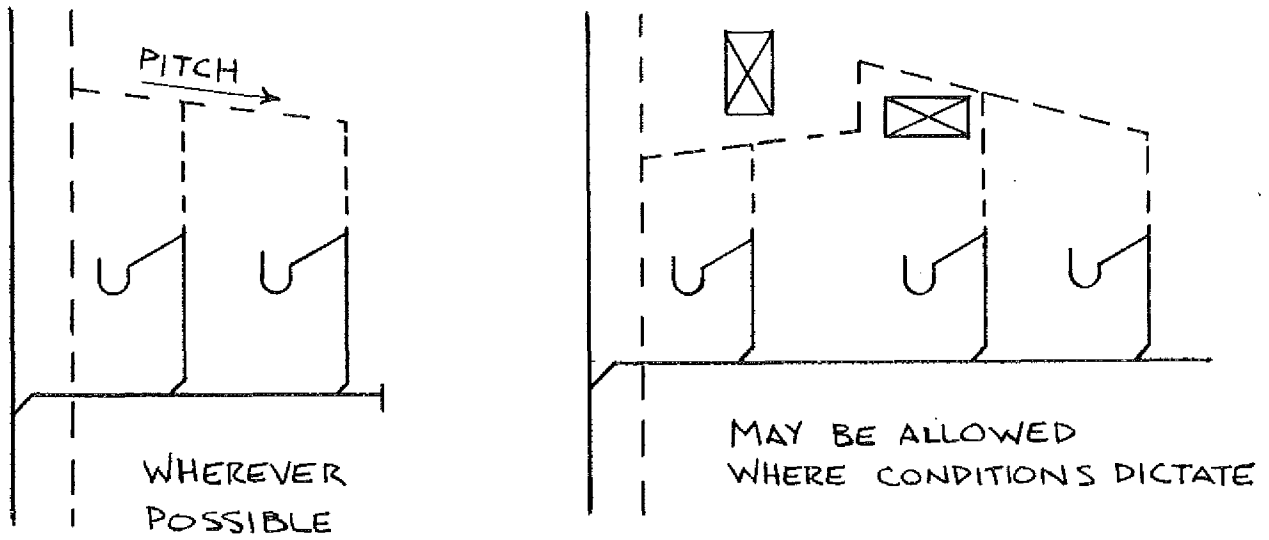

A-82.31 (15) (b) VENT GRADES AND CONNECTIONS.

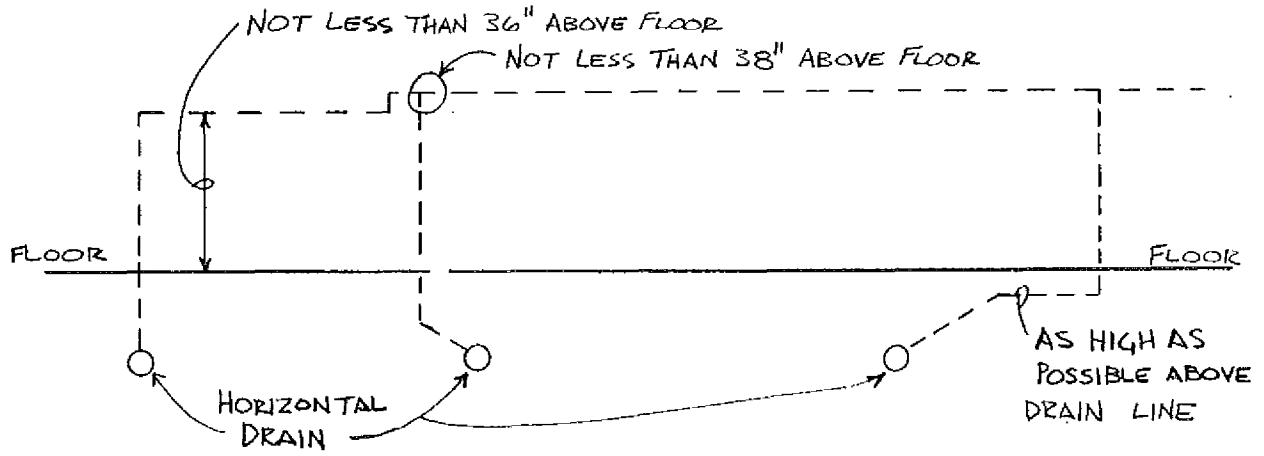

ILHR 82 Appendix

A-82.31 (16) VENT TERMINALS.

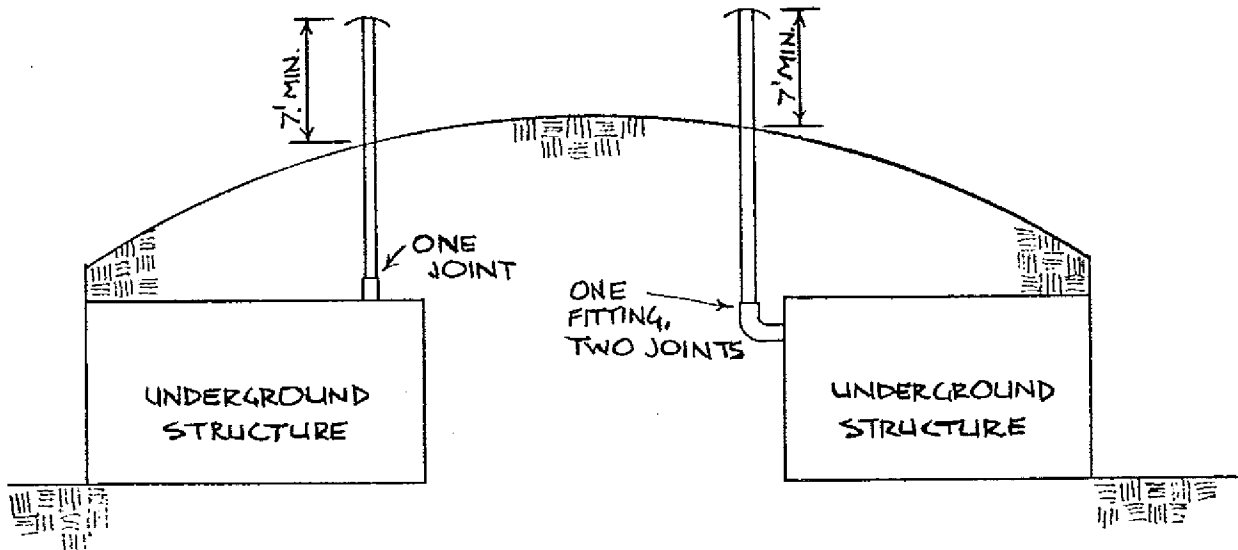
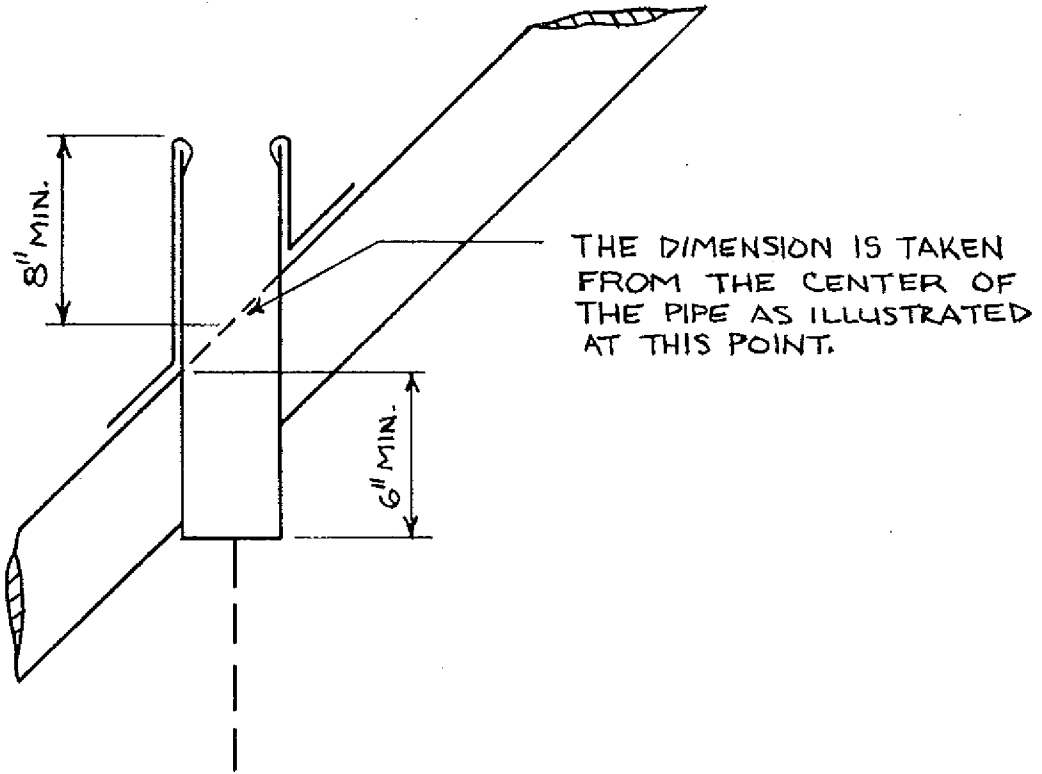

VENT TERMINALS FOR UNDERGROUND STRUCTURES

A-82.31 (17) (a) COMBINATION DRAIN AND VENT STACKS.

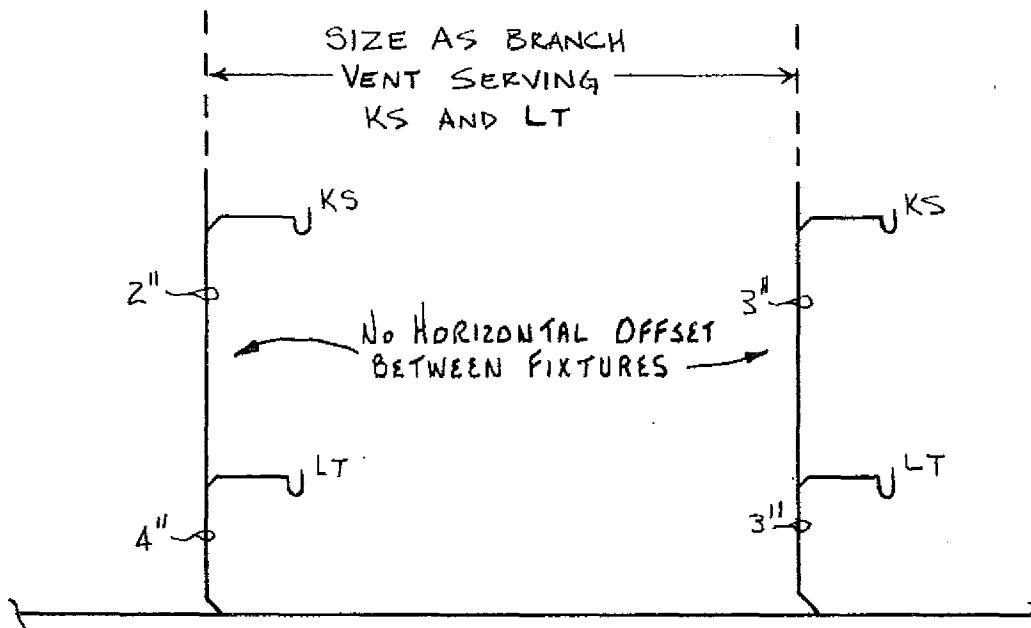
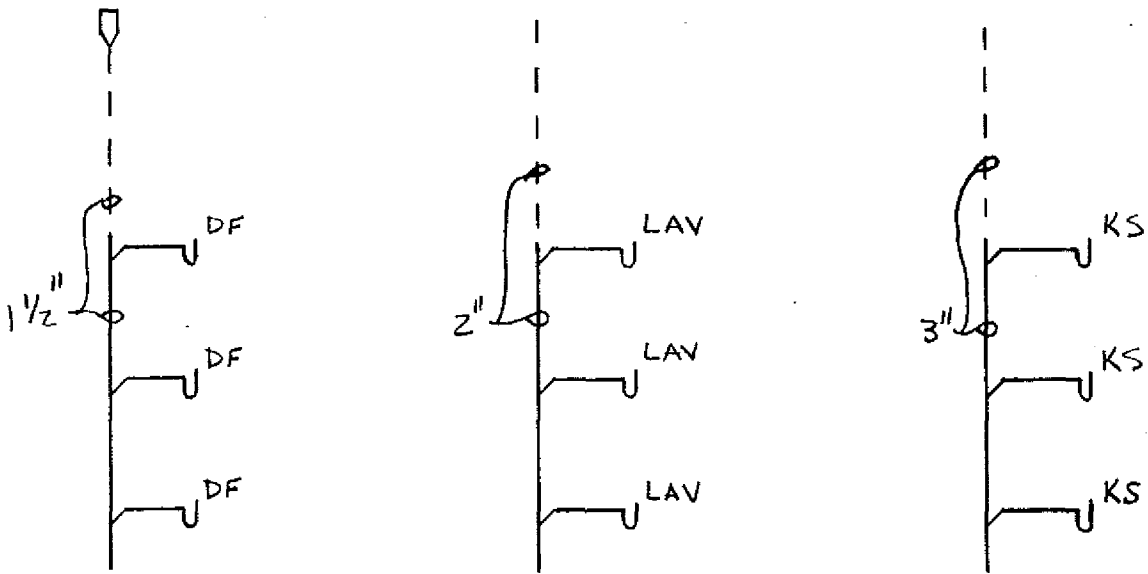

A-82.31 (17) (b) COMBINATION DRAIN AND VENT BUILDING DRAIN.

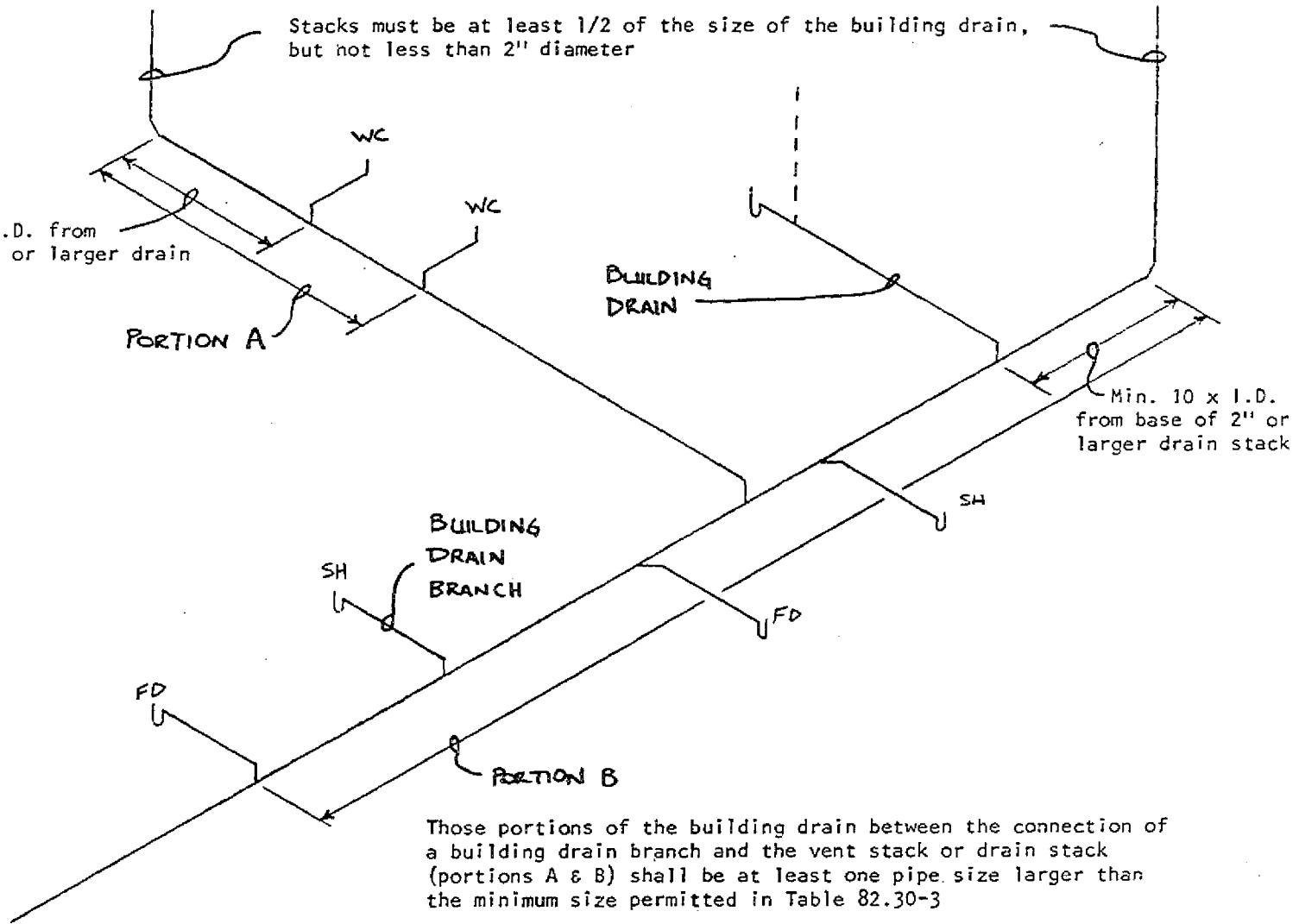

A-82.31 (17) (e) COMBINATION DRAIN AND VENT LABORATORY SINK VENTING.

Stack must be at least 1/2 of the size of the horizontal drain but not less than 2" diameter.

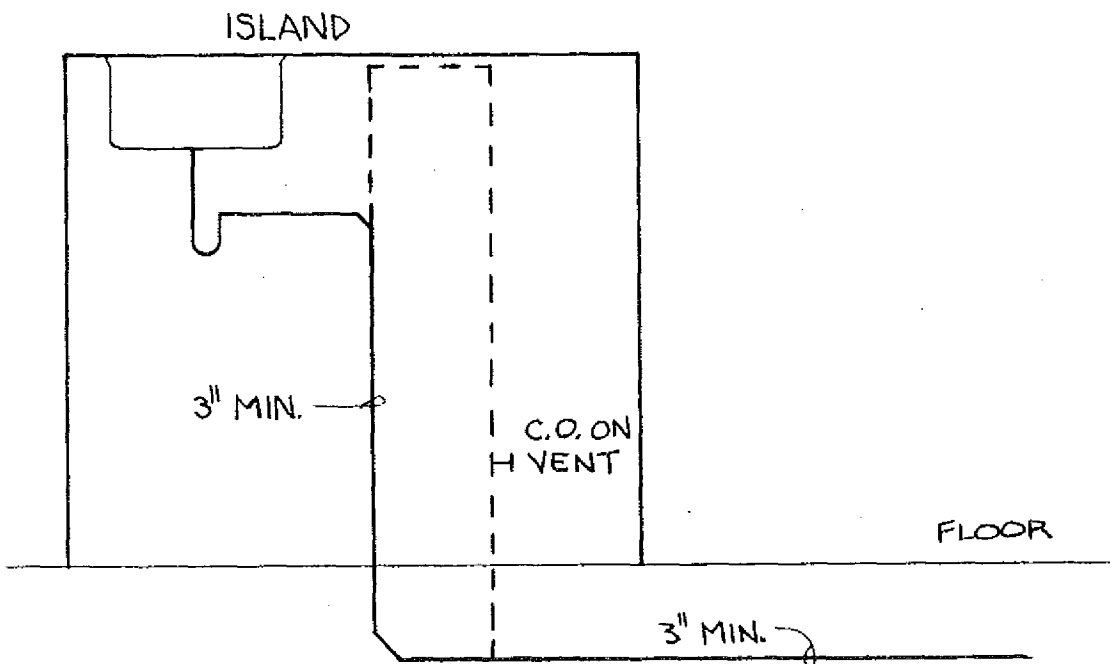
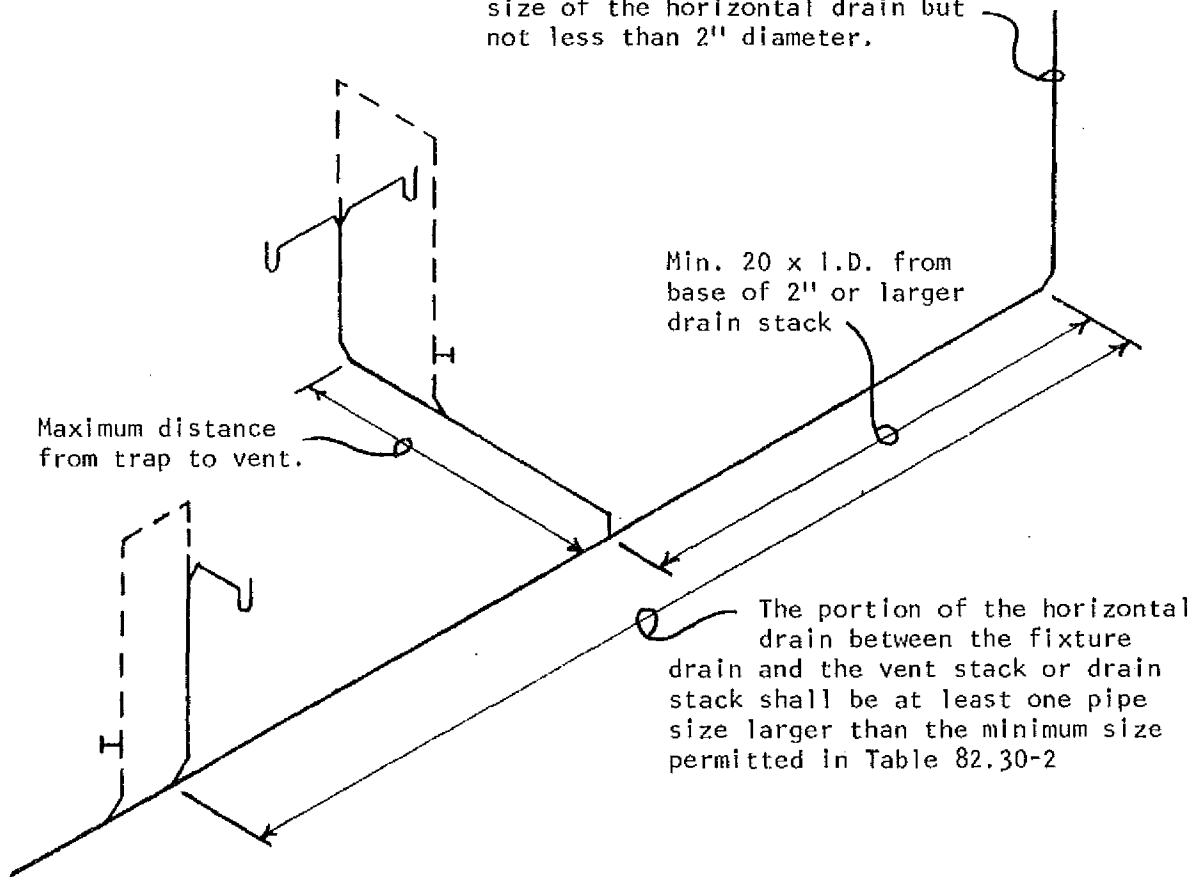

ILHR 82 Appendix

A-82.32 (4) (b) INSTALLATION OF TRAPS.

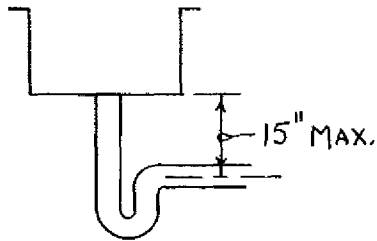

MOST FIXTURES

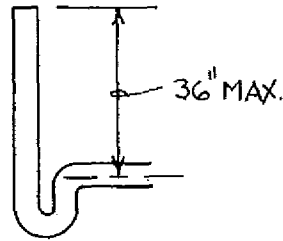

STANDPIPE

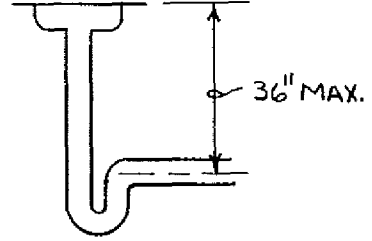

FLOOR DRAIN

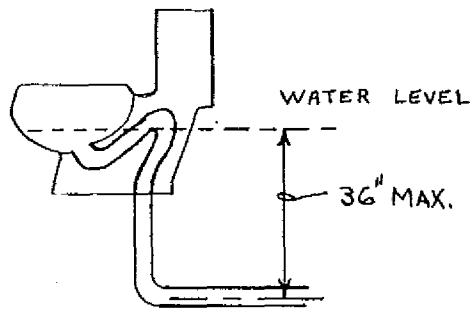

VERTICAL DISTANCE BETWEEN FIXTURE DRAIN OUTLET AND TRAP

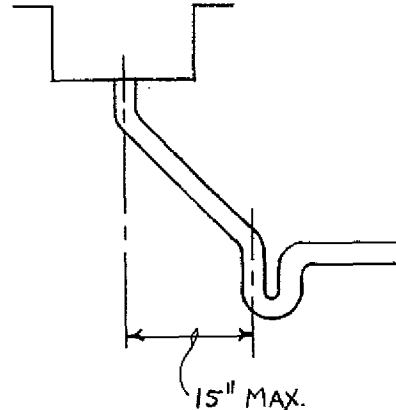
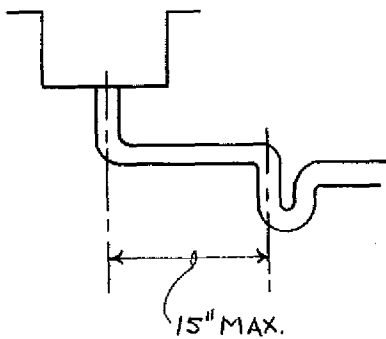

HORIZONTAL DISTANCE BETWEEN FIXTURE DRAIN OUTLET AND TRAP

A-82.33 (6) INDIRECT AND LOCAL WASTE PIPING.

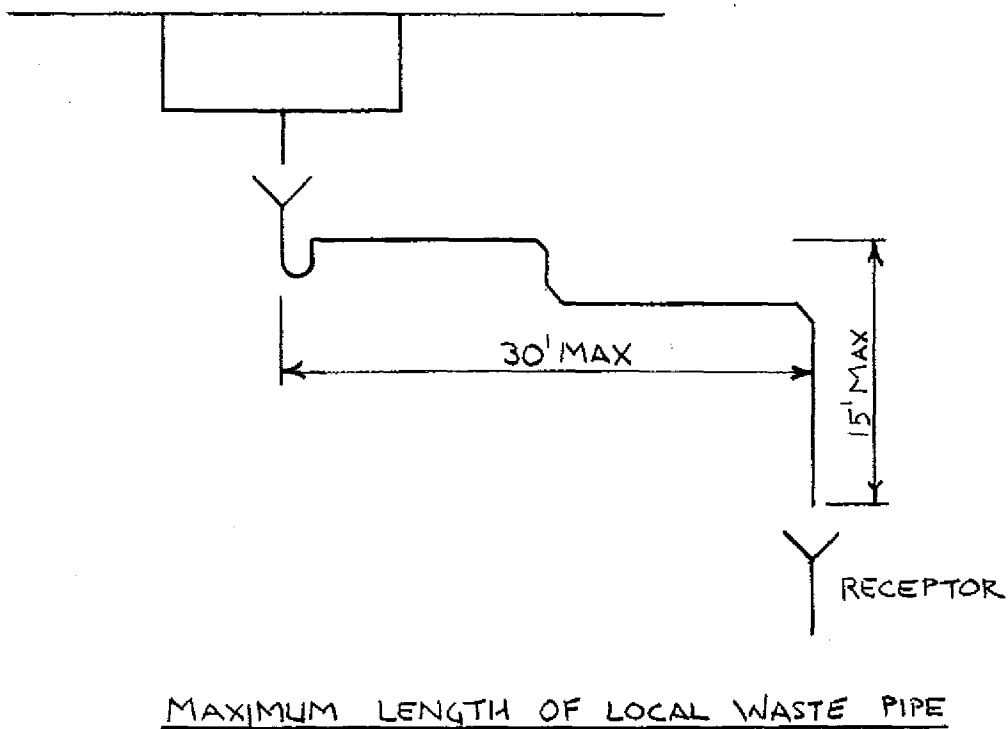
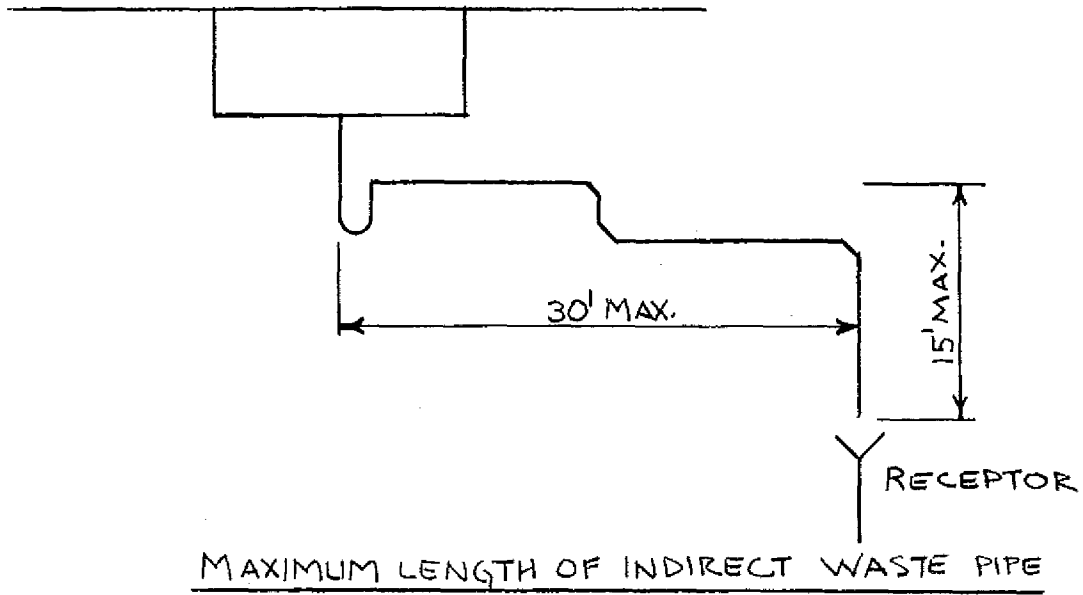

ILHR 82 Appendix

A-82.33 (7) AIR-GAPS AND AIR-BREAKS.

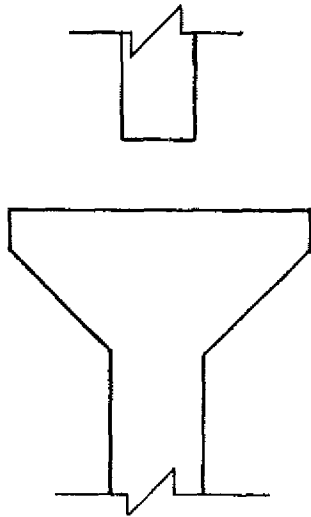

AIR GAP

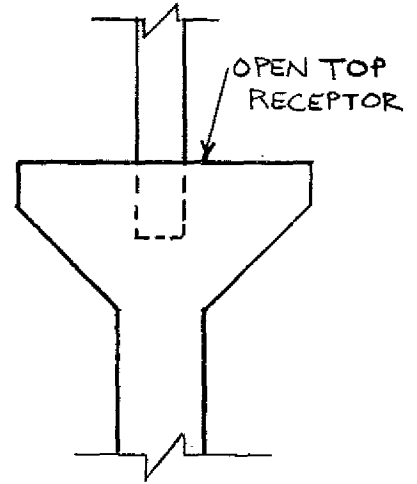

AIR BREAK

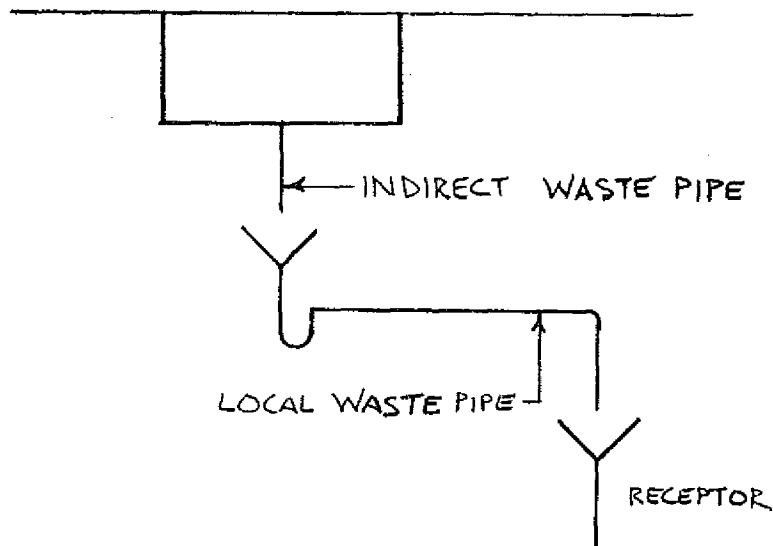

A-82.33 (8) (a) WASTE SINKS AND STANDPIPES.

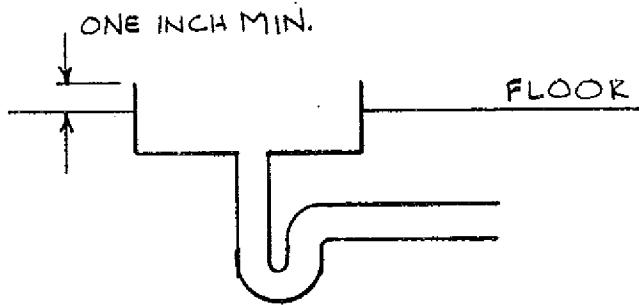

WASTE SINK IN FLOOR

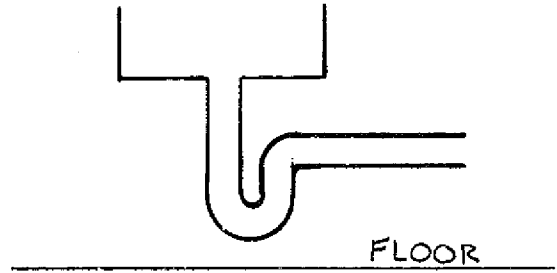

WASTE SINK ABOVE FLOOR

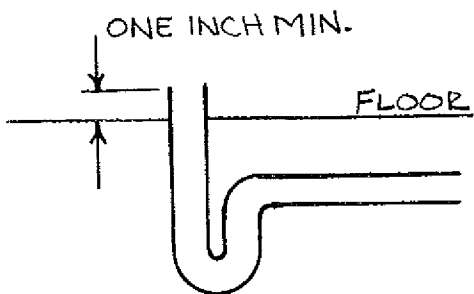

STANDPIPE IN FLOOR

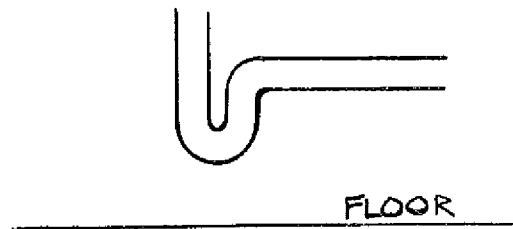

STANDPIPE ABOVE FLOOR

ILHR 82 Appendix

A-82.33 (8) (b) FLOOR SINKS.

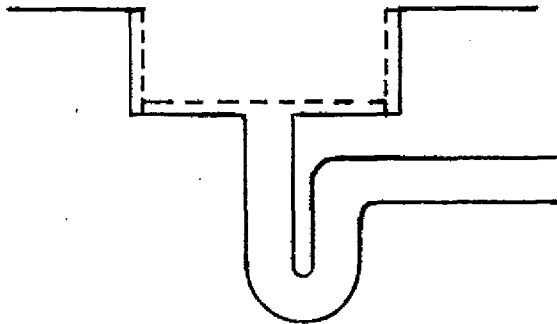

FLOOR SINK WITH BASKET

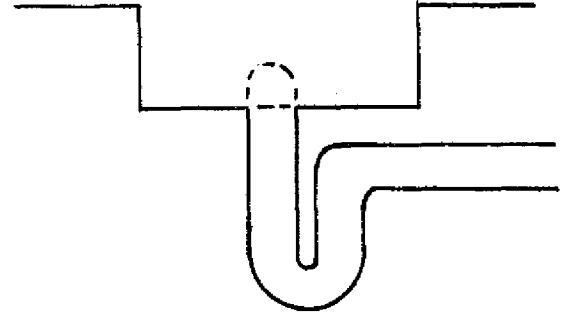

FLOOR SINK WITH DOME STRAINER

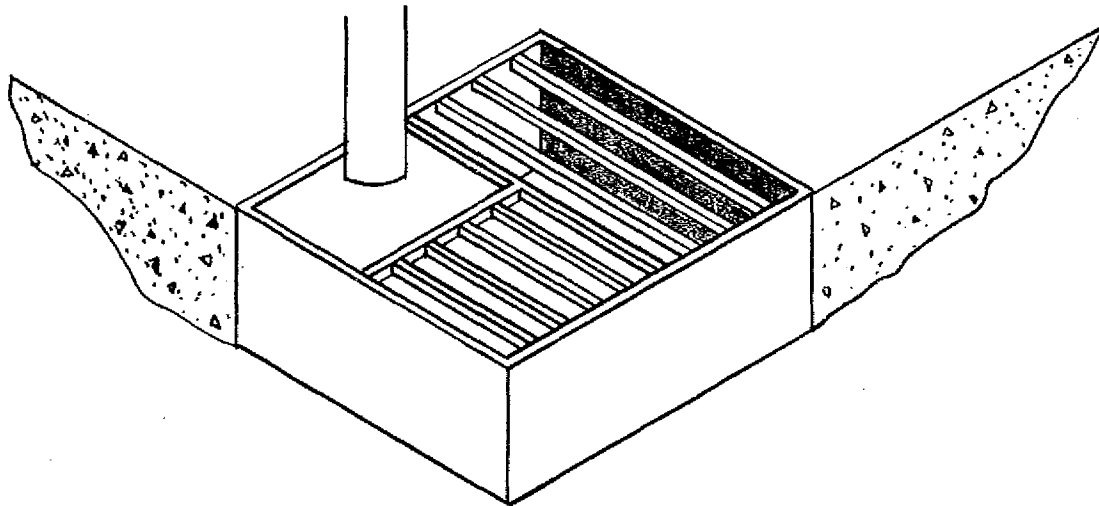

FLOOR SINK WITH GRATE OPENING
FOR AIR GAP

A-82.33 (8) (c) LOCAL WASTE PIPING.

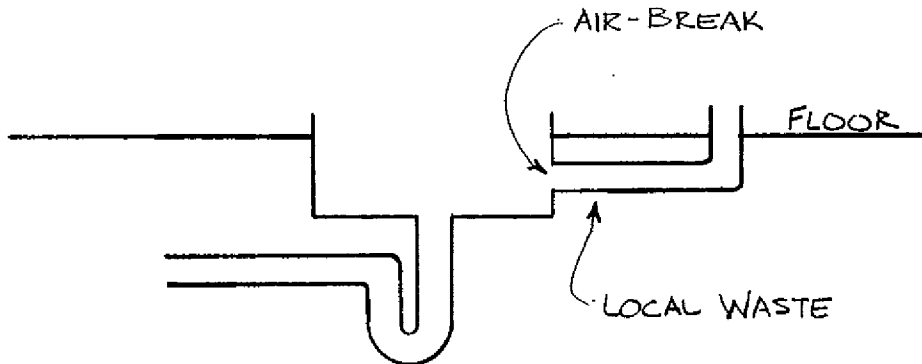

LOCAL WASTE LEADING TO A WASTE SINK,
FLOOR SINK OR FLOOR DRAIN

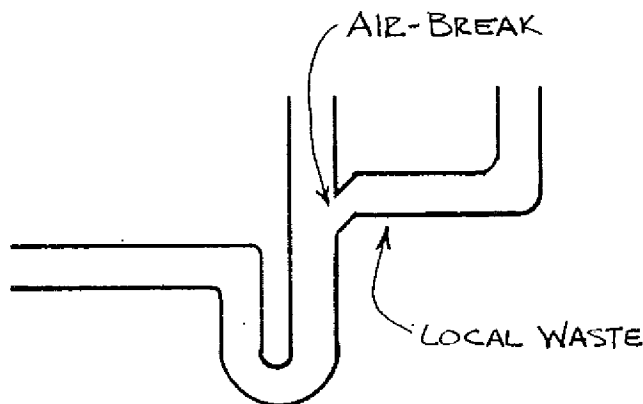

LOCAL WASTE LEADING TO A STANDPIPE

ILHR 82 Appendix

A-82.33 (8) (c) LOCAL WASTE PIPING SERVING WATER HEATER RELIEF VALVES.

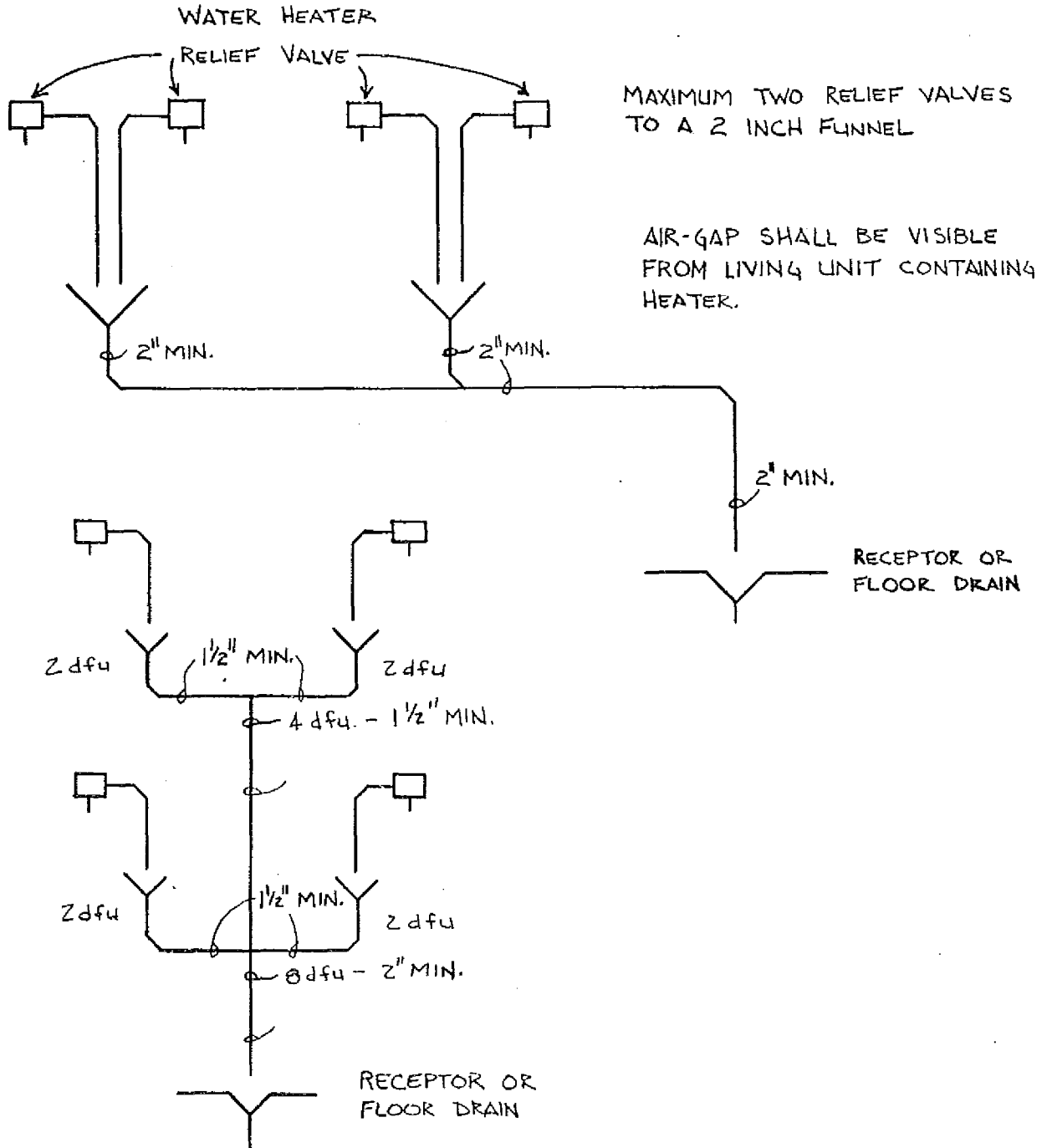

LOCAL WASTE PIPES SERVING
WATER HEATER RELIEF VALVES.

A-82.33 (9) (c) COMMERCIAL GRAVITY DISCHARGE-TYPE CLOTHES WASHERS.

TRENCH TYPE LAUNDRY RECEPTOR

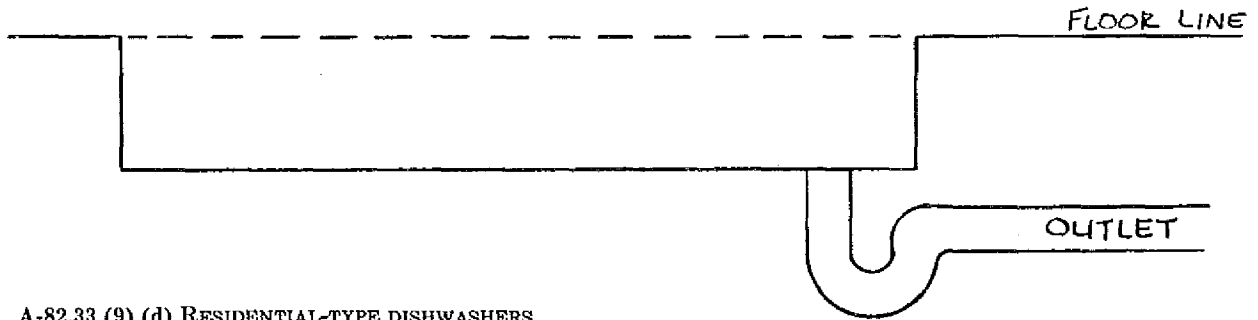

A-82.33 (9) (d) RESIDENTIAL-TYPE DISHWASHERS.

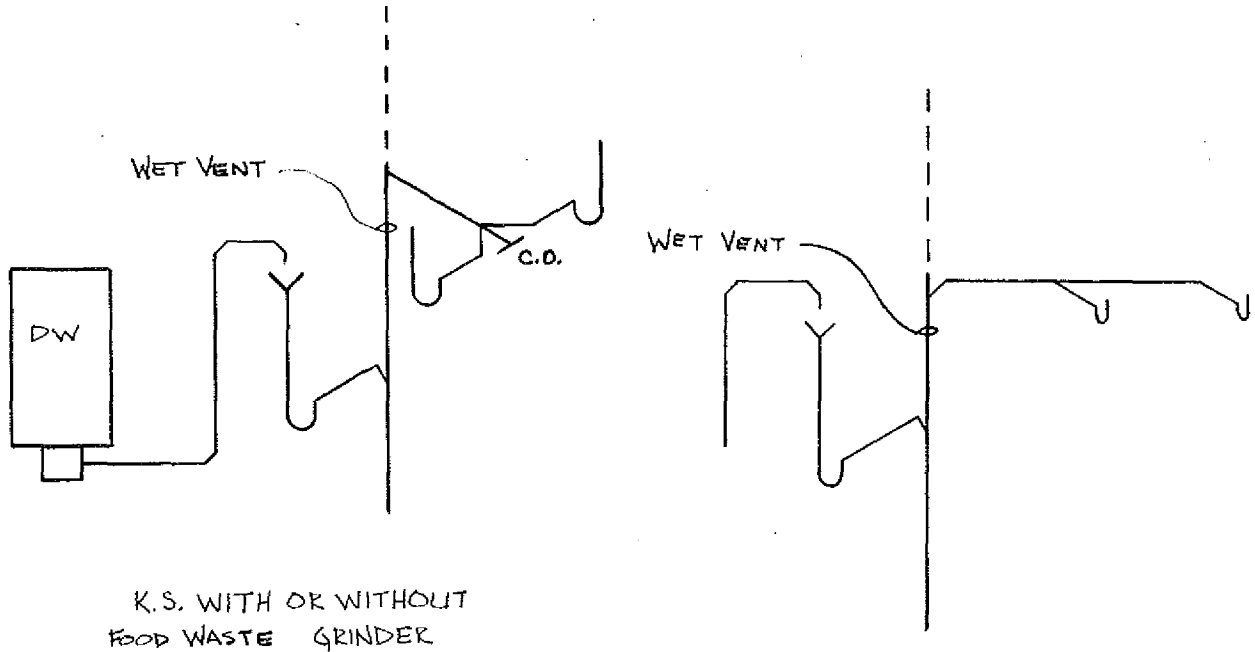

K.S. WITH OR WITHOUT
FOOD WASTE GRINDER

KS. WITH OR WITHOUT
FOOD WASTE GRINDER

DISWASHER DISCHARGING TO A STANDPIPE
BELOW THE COUNTER TOP.

A-82.33 (9) (d) RESIDENTIAL-TYPE DISHWASHERS.

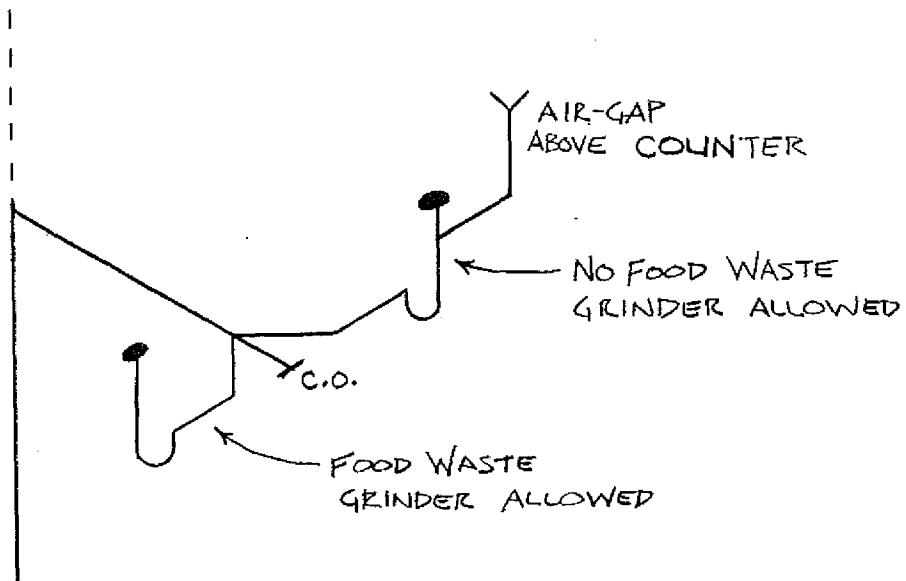
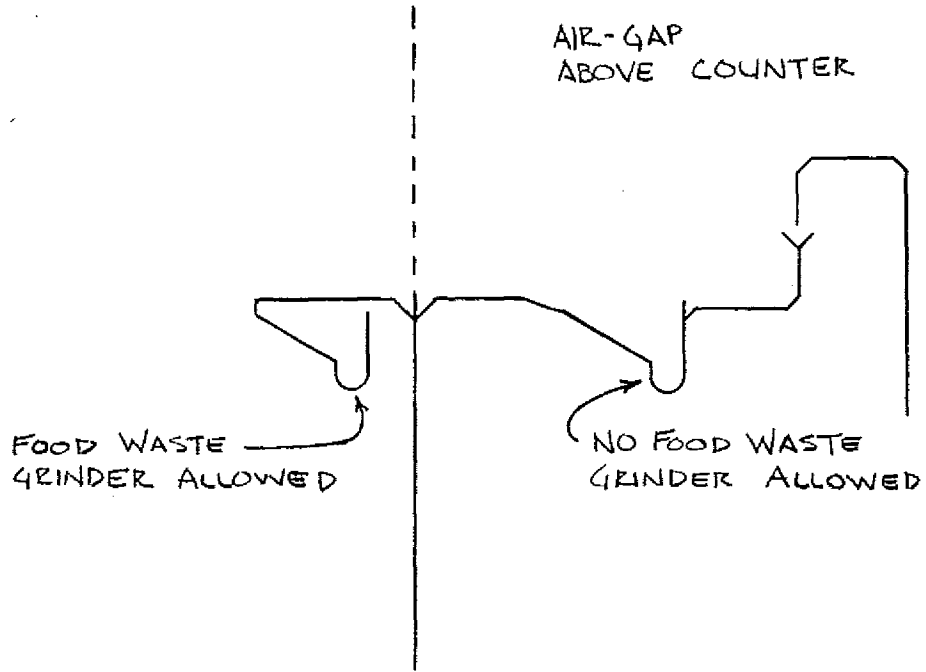

A-82.33 (9) (d) RESIDENTIAL-TYPE DISHWASHERS.

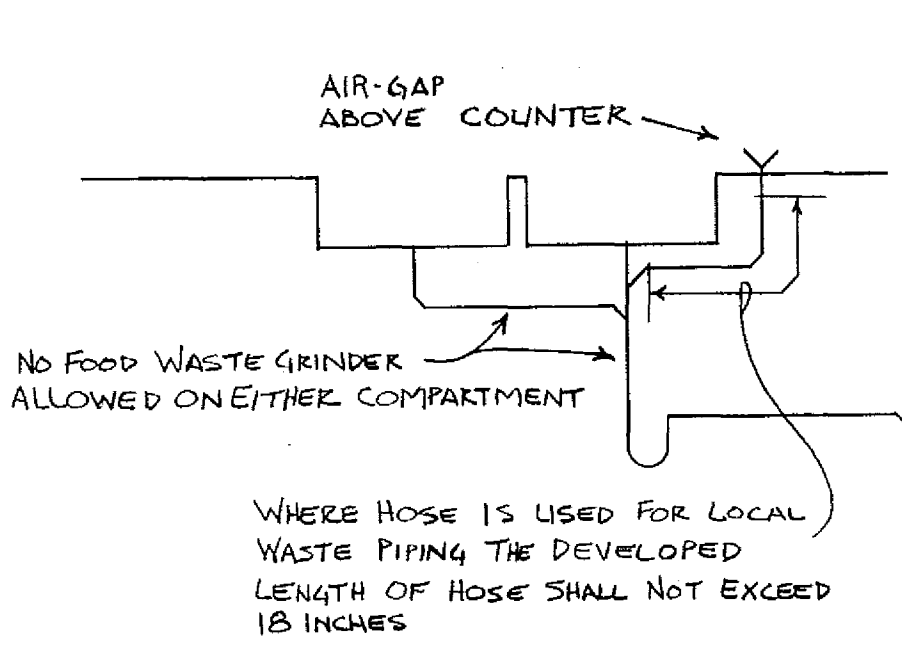
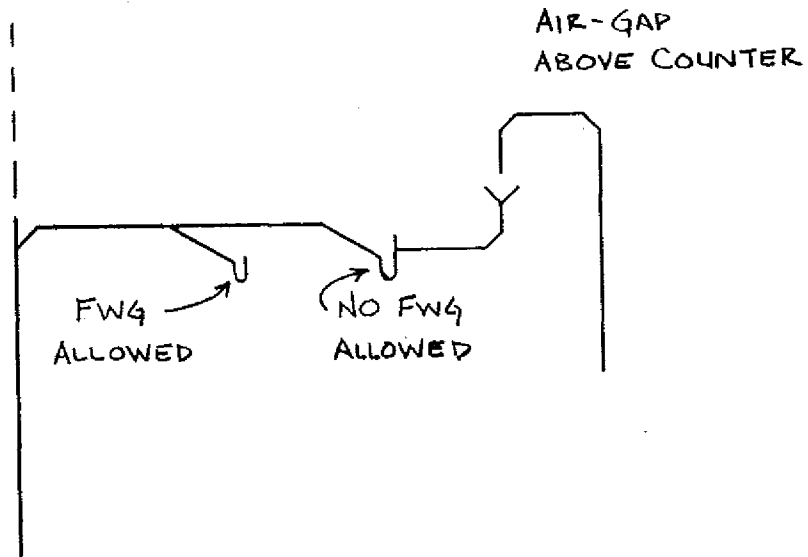

ILHR 82 Appendix

A-82.33 (9) (d) COMMERCIAL DISHWASHERS.

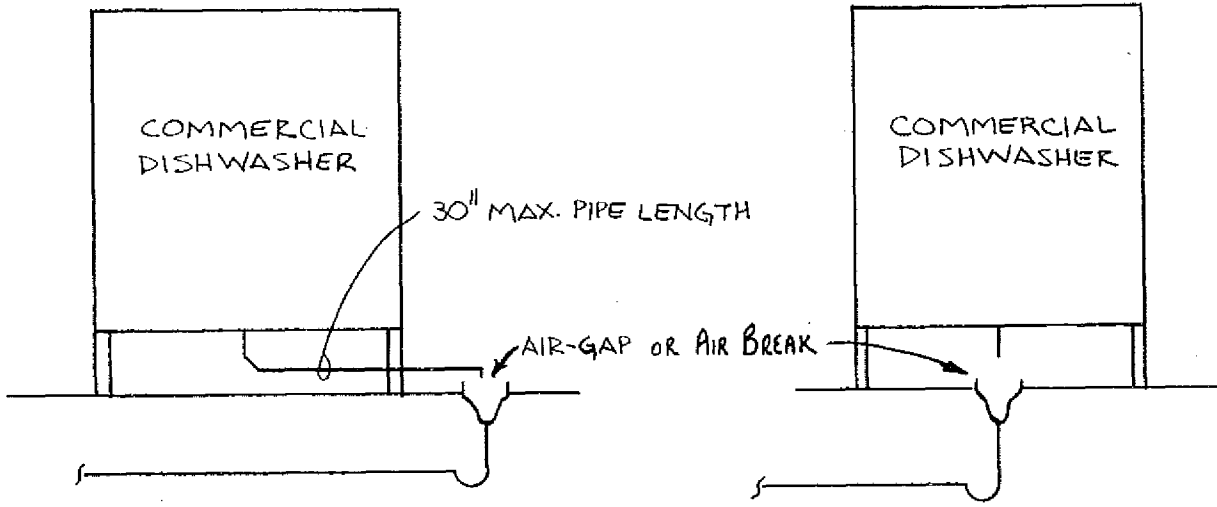

A-82.33 (9) (f) ELEVATOR PIT SUBSOIL AND FLOOR DRAINS.

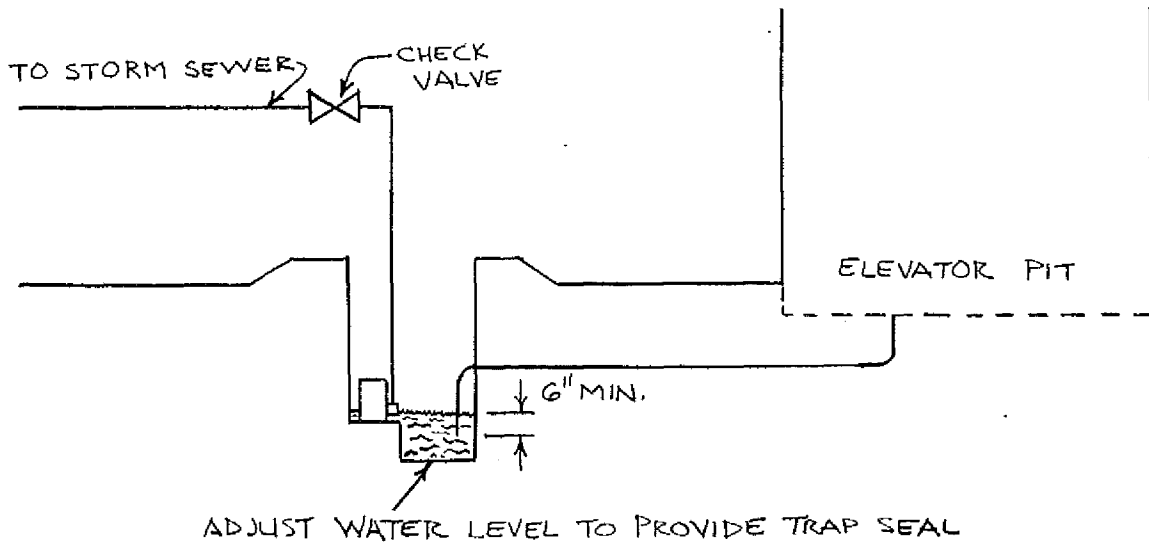

A-82.33 (9) (g) 1. BAR AND SODA FOUNTAIN SINKS.

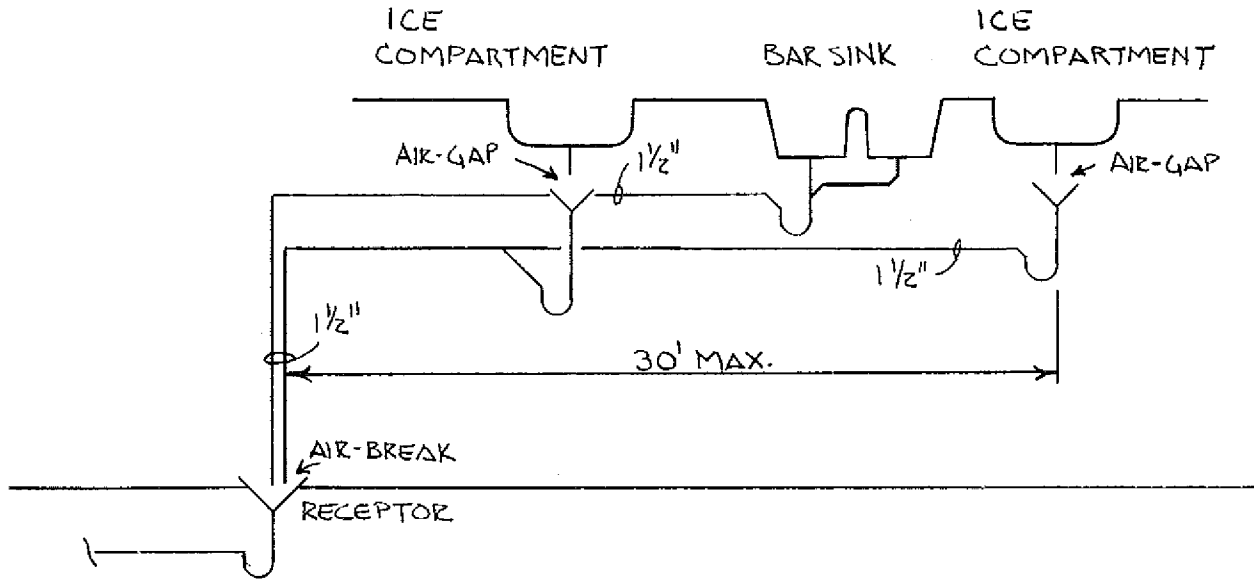

A-82.33 (9) (g) 2.

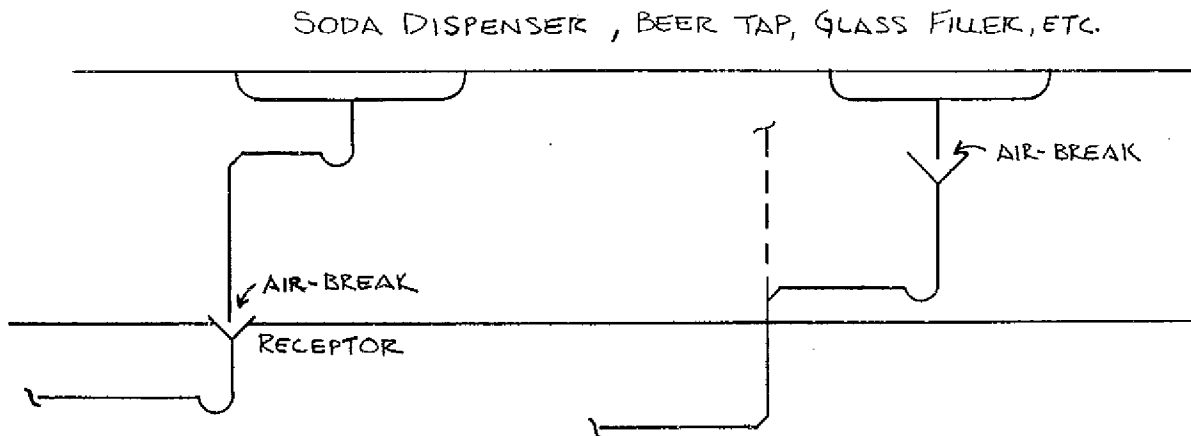

ILHR 82 Appendix

A-82.33 (9) (g) 3. NOVELTY BOXES, AND ICE COMPARTMENTS AND ICE CREAM DIPPER WELLS.

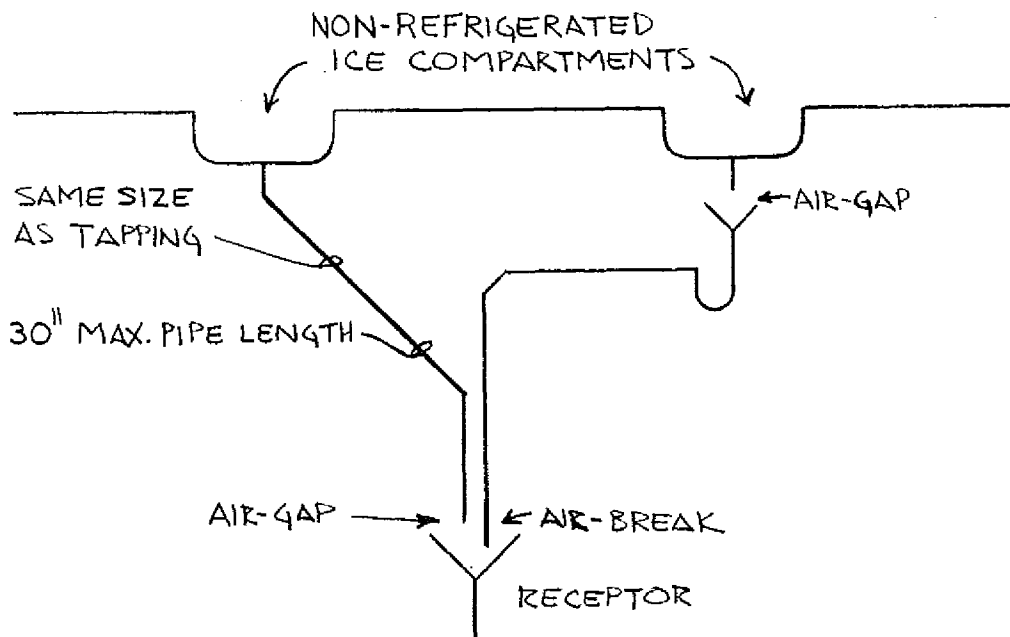
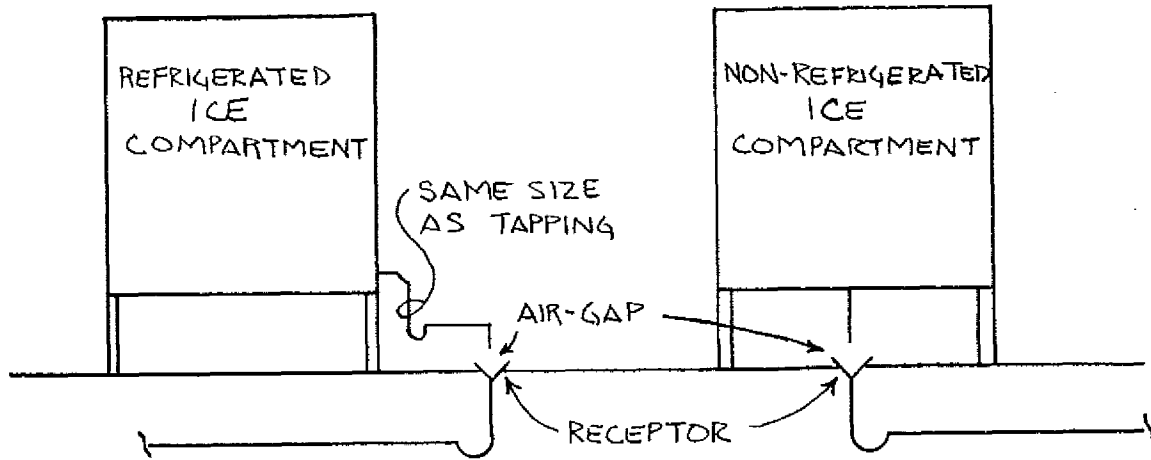

A-82.33 (9) (g) 4. REFRIGERATED FOOD STORAGE ROOMS, COMPARTMENTS, AND DISPLAY CASES.

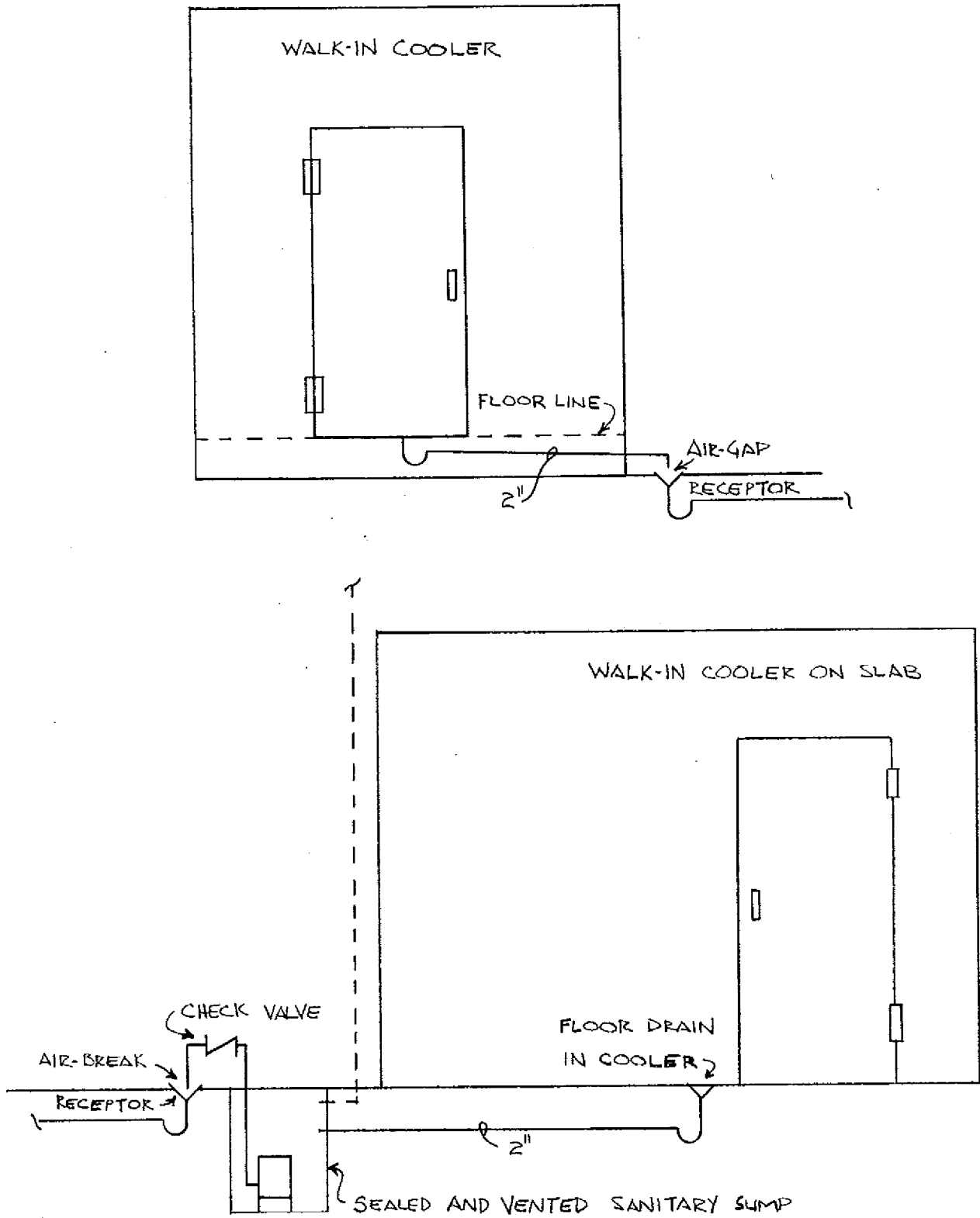

ILHR 82 Appendix

A-82.33 (9) (g) 5. MISCELLANEOUS FOOD HANDLING EQUIPMENT.

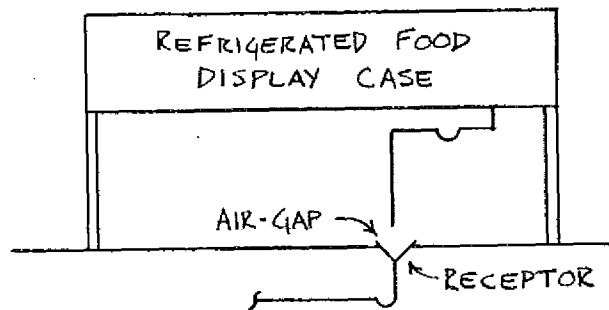
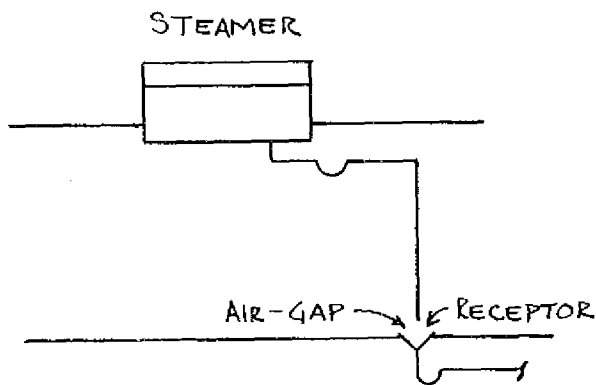
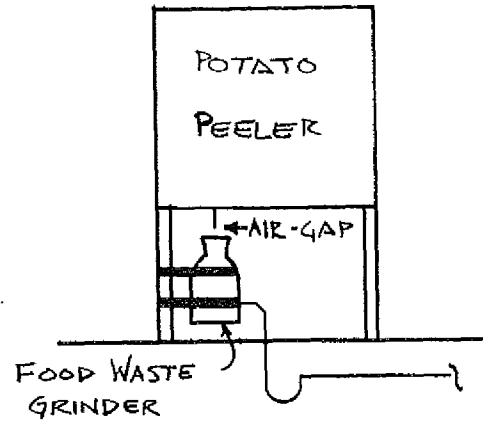
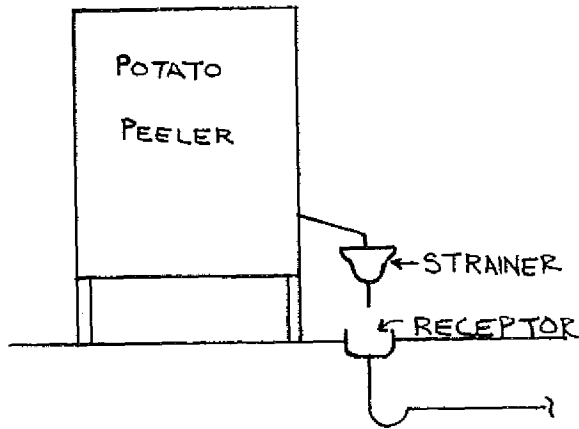

A-82.33 (9) (g) 5. MISCELLANEOUS FOOD HANDLING EQUIPMENT.

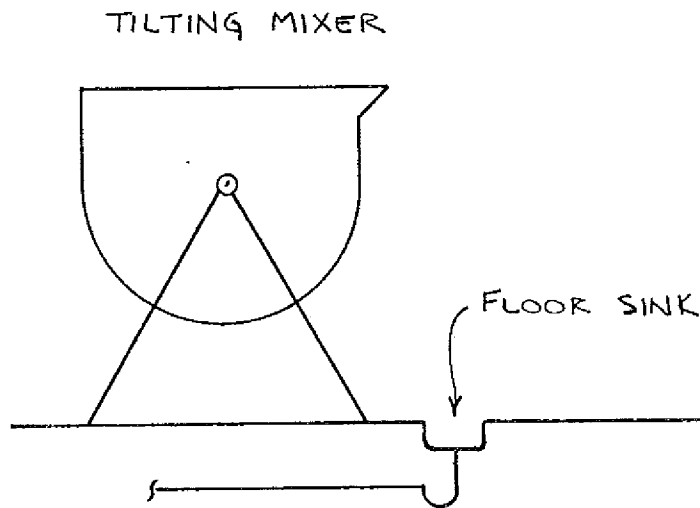
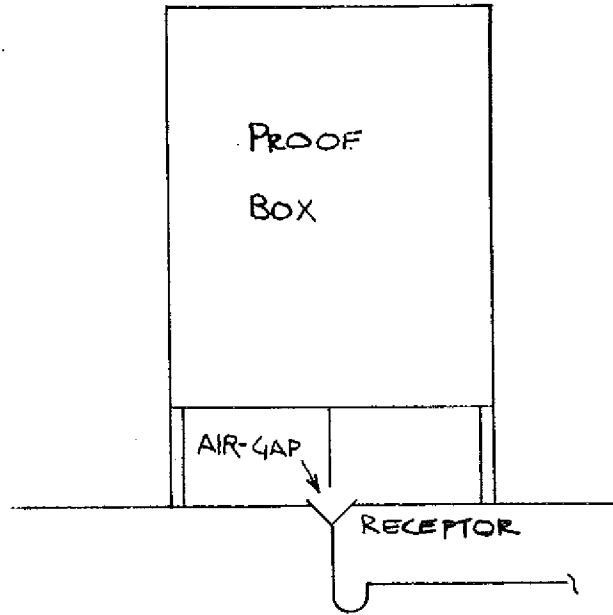

ILHR 82 Appendix

A-82.33 (9) (g) 5. MISCELLANEOUS FOOD HANDLING EQUIPMENT.

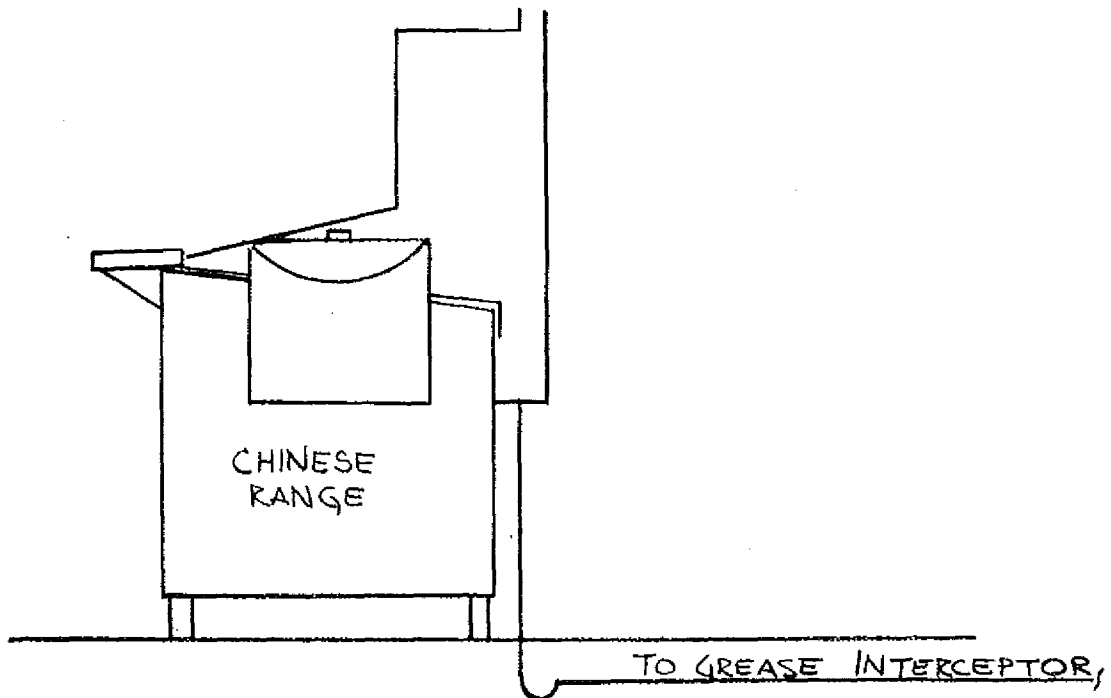
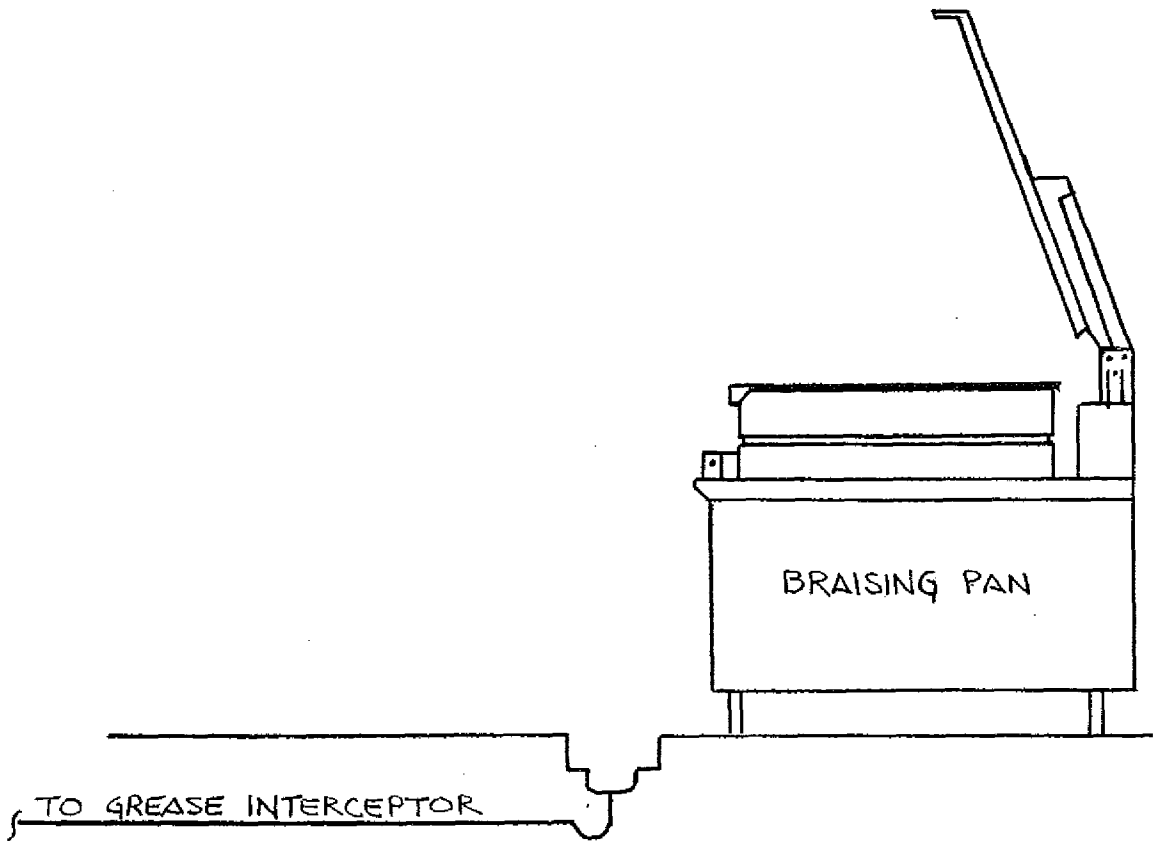

A-82.33 (9) (g) 5. MISCELLANEOUS FOOD HANDLING EQUIPMENT.

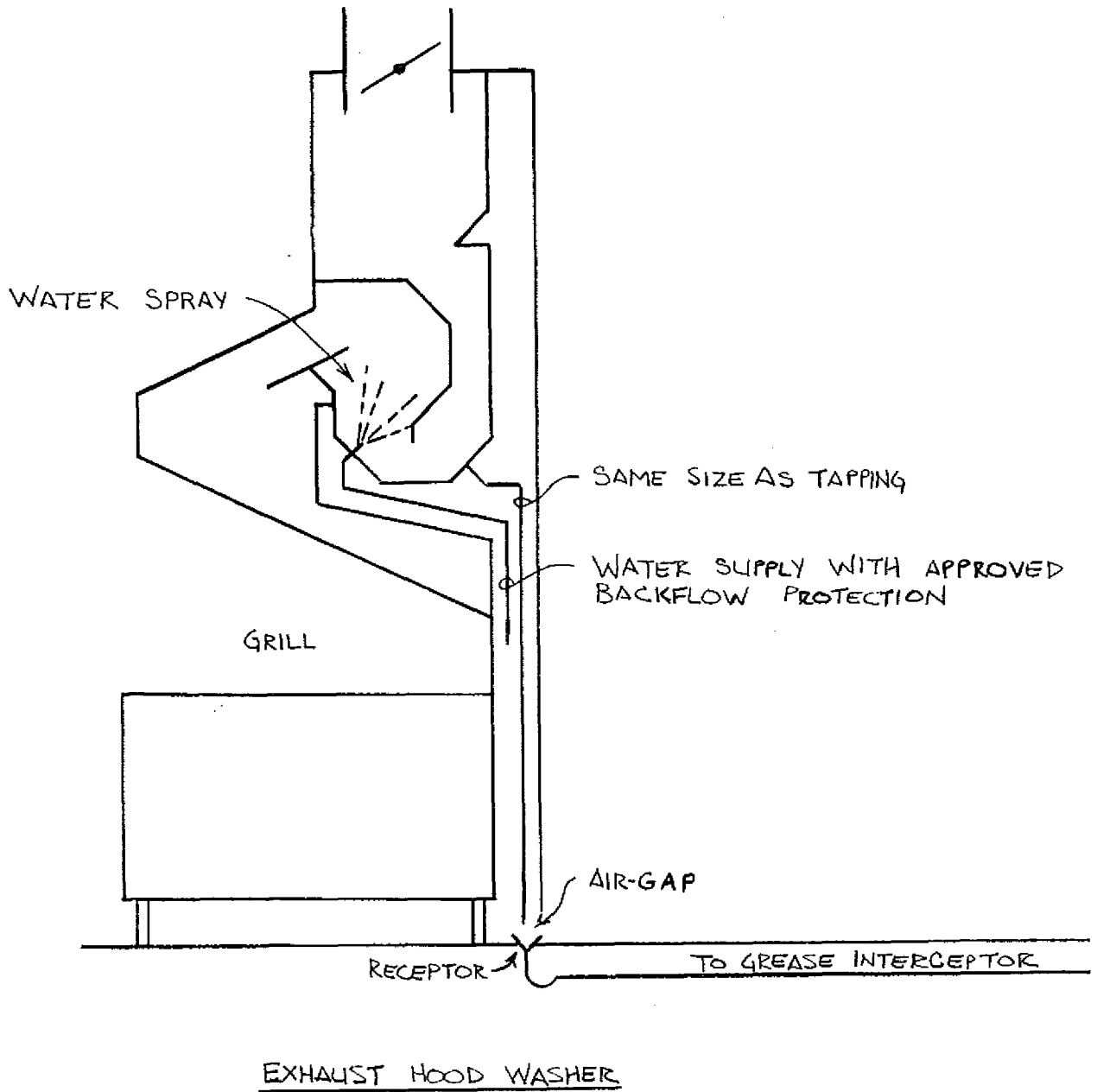

ILHR 82 Appendix

A-82.34 (4) (a).

GARAGE CATCH BASIN

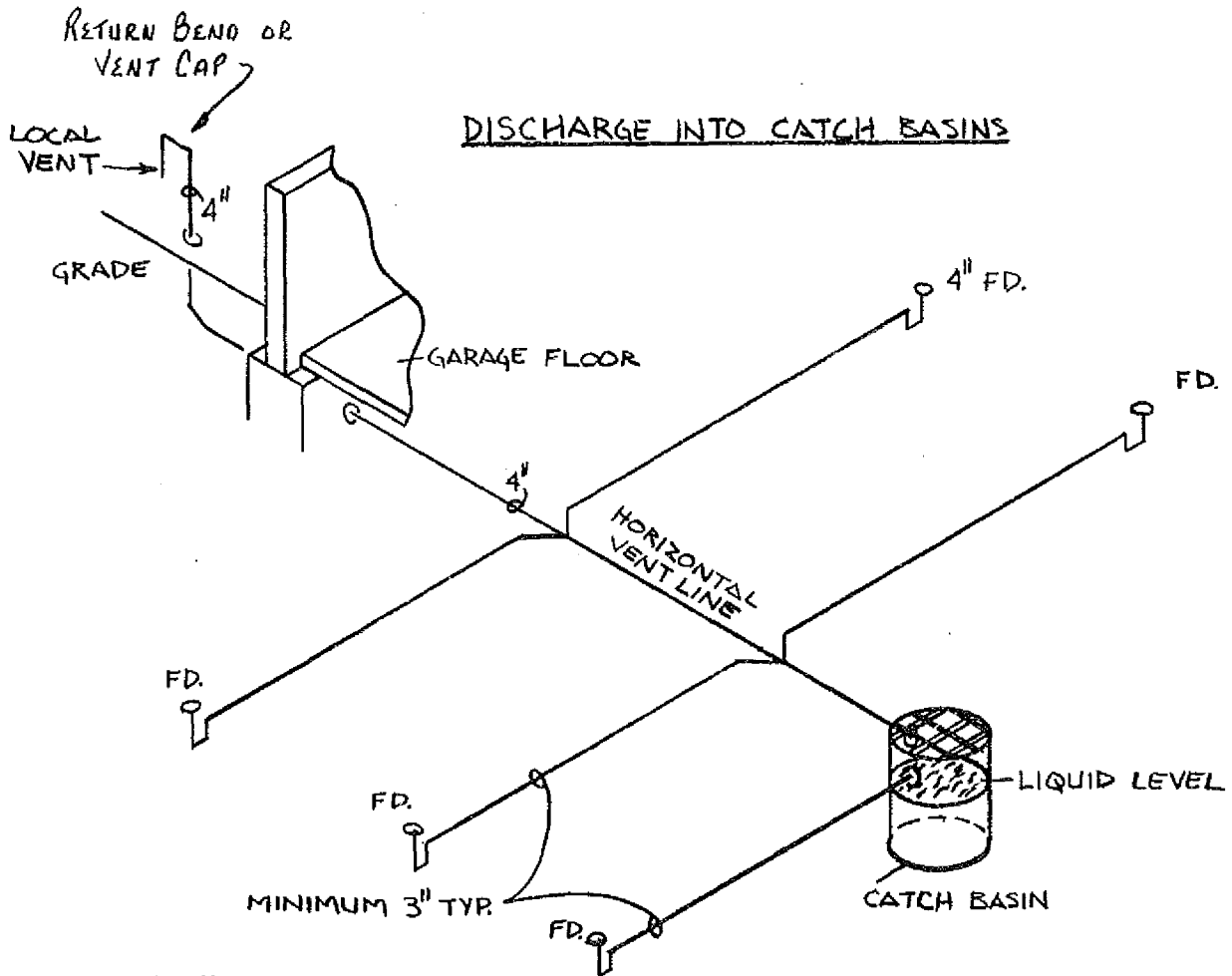
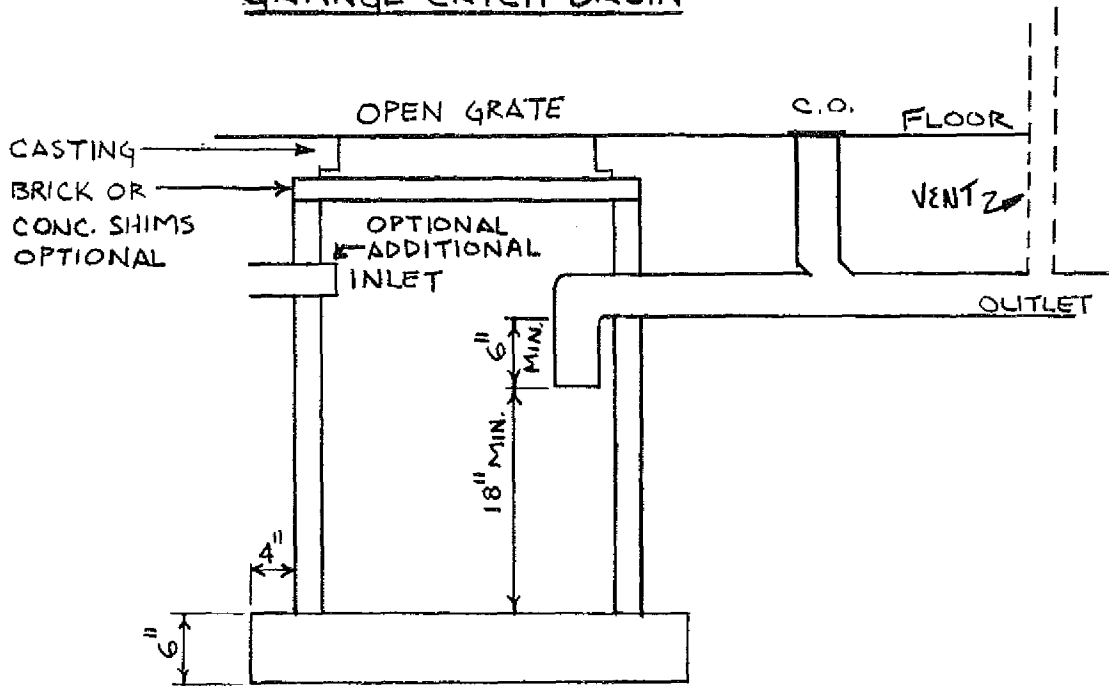

A-82.34 (4) (a)

Capacity of Catch Basins
(in cubic feet)

| Diameter of Catch Basin | Volume in cubic feet per foot of depth | Diameter of Catch Basin | Volume in cubic feet per foot of depth |
|-------------------------|--|-------------------------|--|
| 36 | 7.1 | 45 | 11.1 |
| 37 | 7.5 | 46 | 11.6 |
| 38 | 7.9 | 47 | 12.1 |
| 39 | 8.3 | 48 | 12.6 |
| 40 | 8.7 | 54 | 15.9 |
| 41 | 9.2 | 60 | 19.7 |
| 42 | 9.7 | 66 | 23.8 |
| 43 | 10.1 | 72 | 28.3 |
| 44 | 10.6 | 84 | 38.6 |

A-82.34 (4) (a)

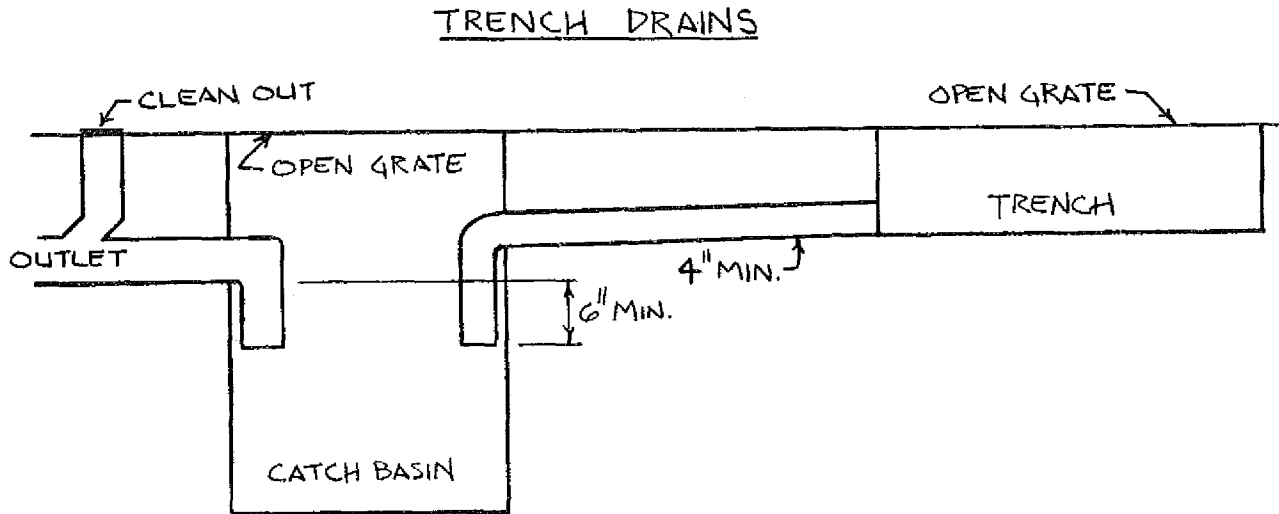

TYPICAL FLOOR DRAIN WITH SOLID BOTTOM SEDIMENT BASKET

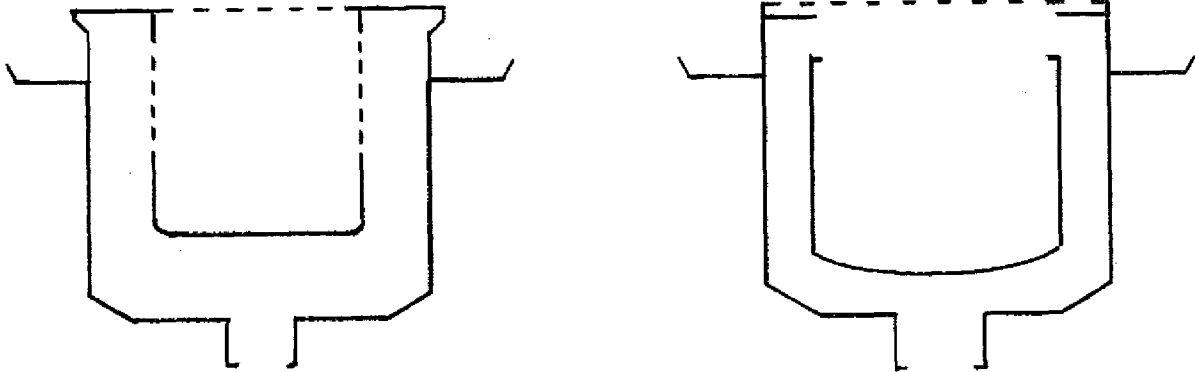

A-82.34 (5) (b)

GREASE INTERCEPTOR MANHOLE LOCATION

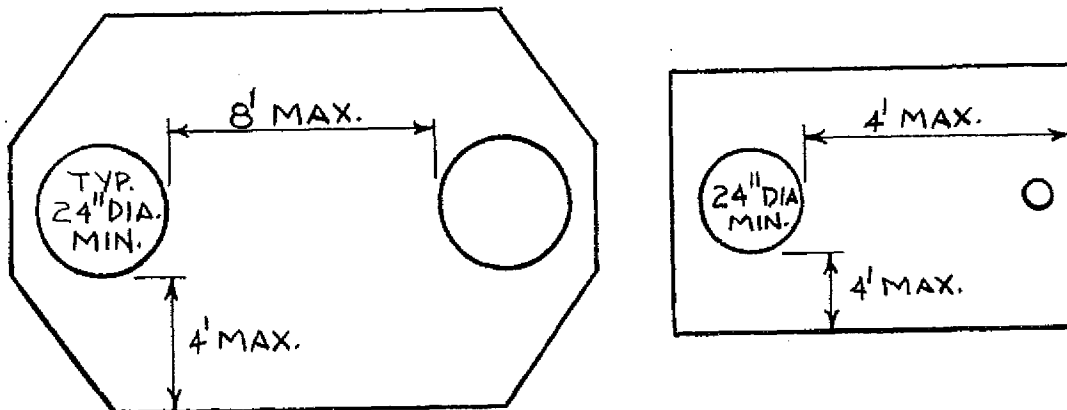

A-82.34 (5) (b)

EXTERIOR GREASE INTERCEPTOR

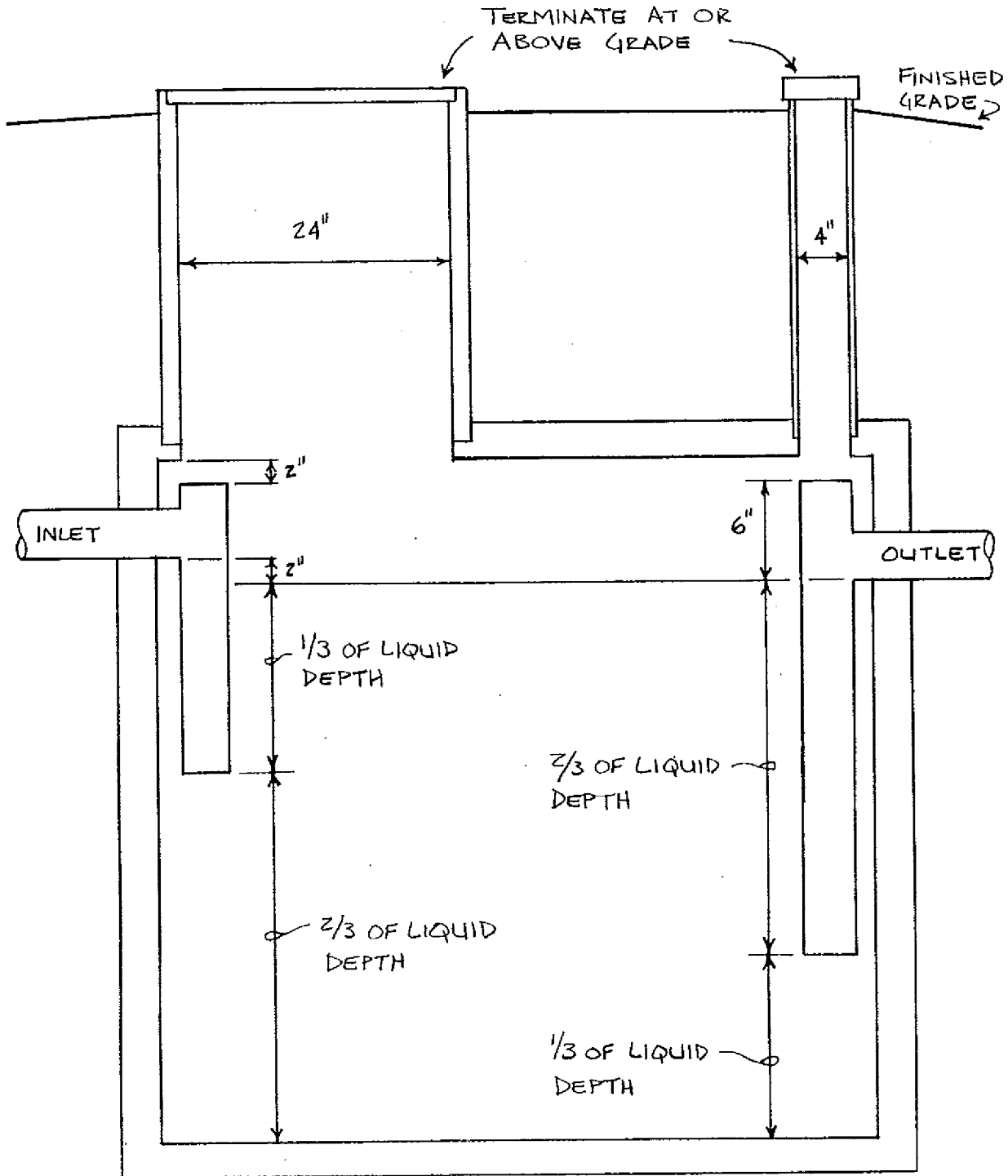

ILHR 82 Appendix

A-82.34 (5) (c) INTERIOR GREASE INTERCEPTORS.

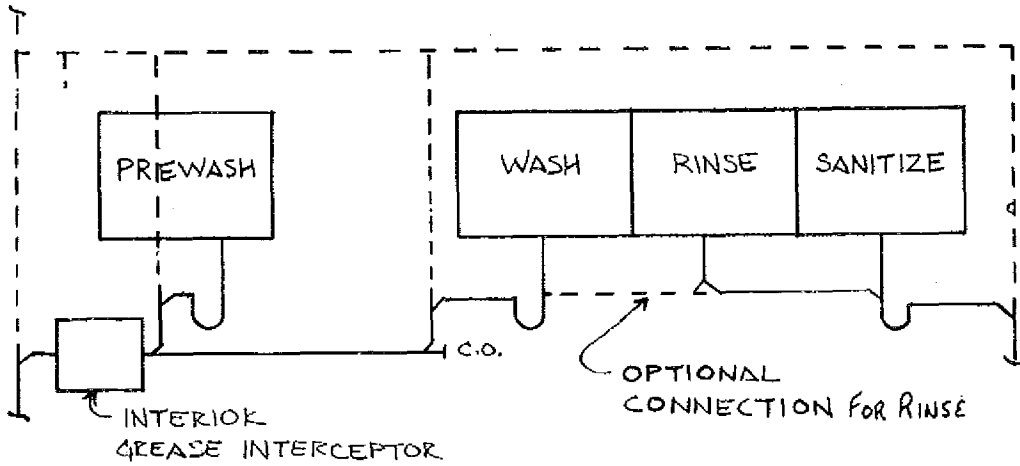

PREWASH AND 3 COMPARTMENT SCULLERY SINK

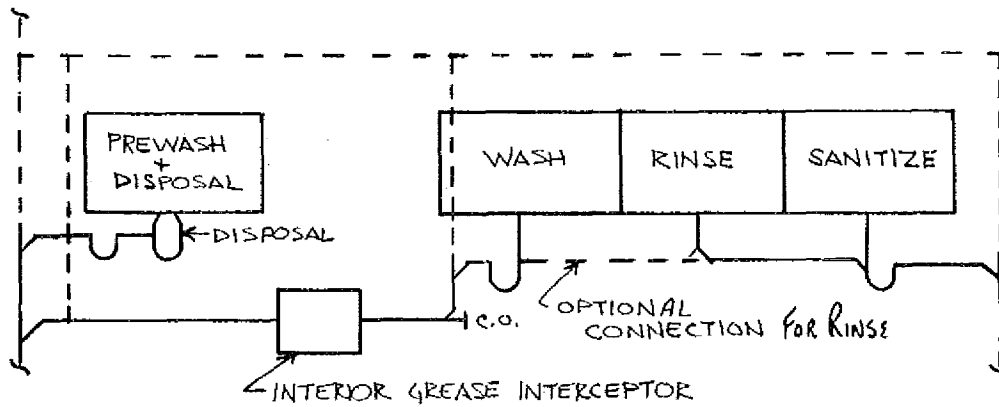

PREWASH + DISPOSAL + 3 COMPARTMENT SCULLERY SINK

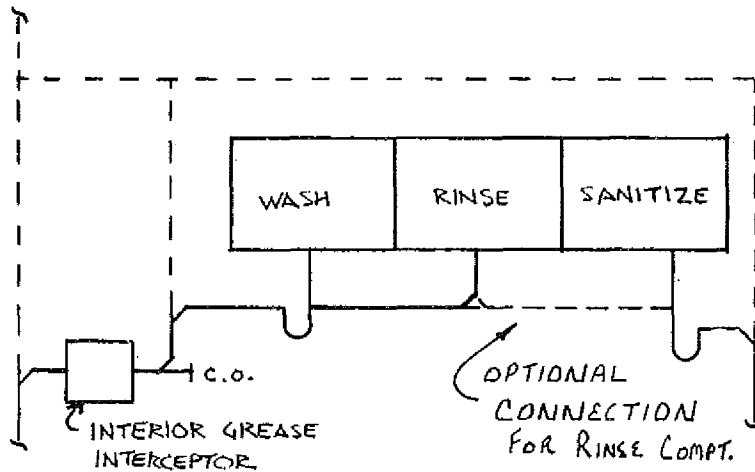

3 COMPARTMENT SCULLERY SINK

Note: Rinse and sanitize compartments and garbage disposals may discharge through interior grease interceptors.

A-82.34 (6) AUTOMATIC CAR WASHES.

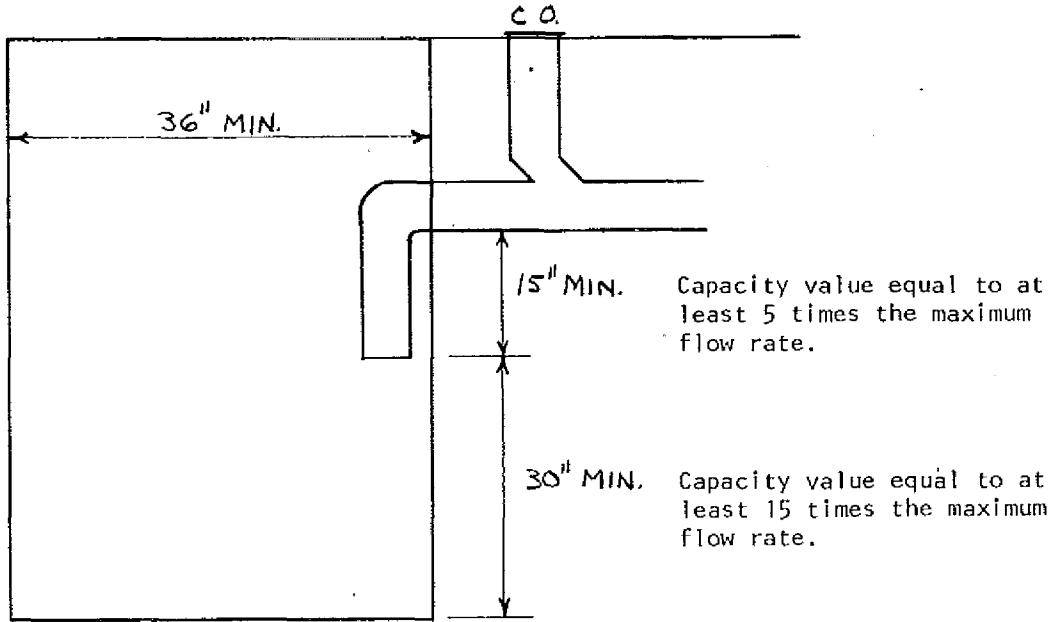

CAR WASH INTERCEPTOR WITH INVERT INSIDE OF BASIN

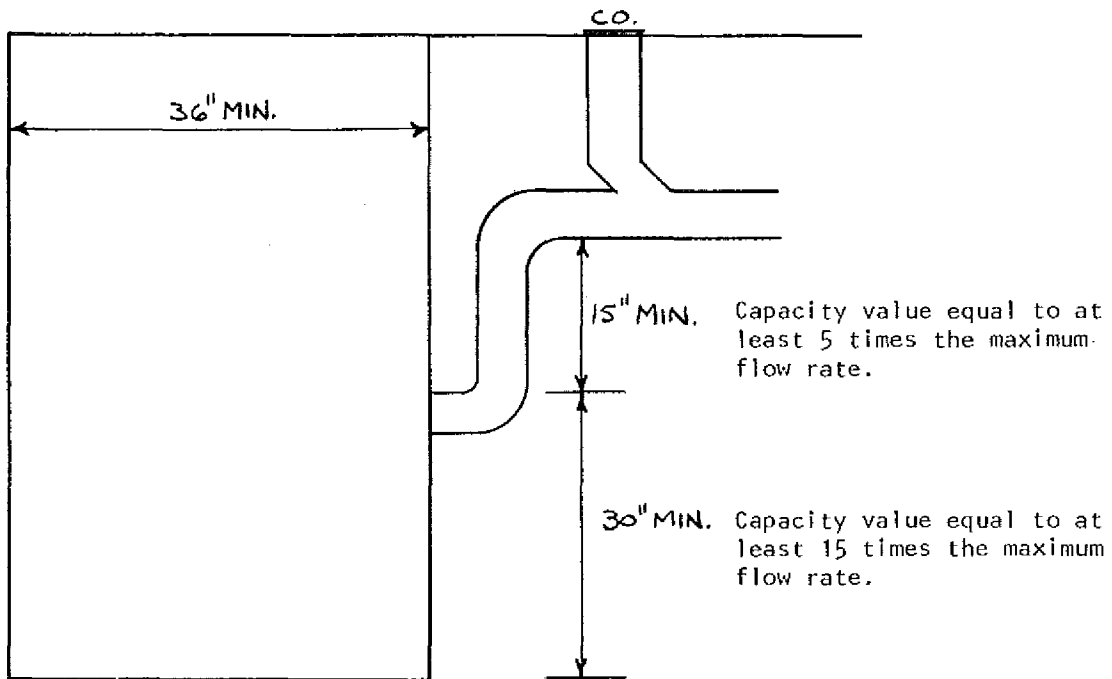

CAR WASH INTERCEPTOR WITH INVERT OUTSIDE OF BASIN

TRENCH TYPE LAUNDRY INTERCEPTOR

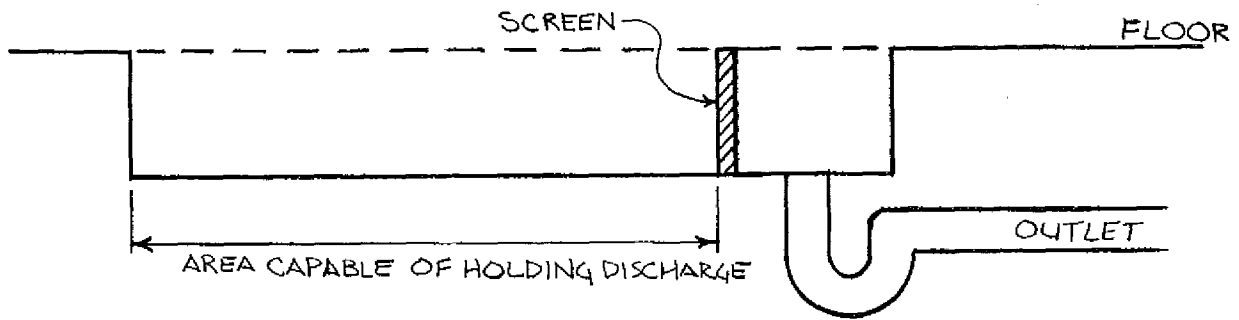

IN-LINE LAUNDRY INTERCEPTOR

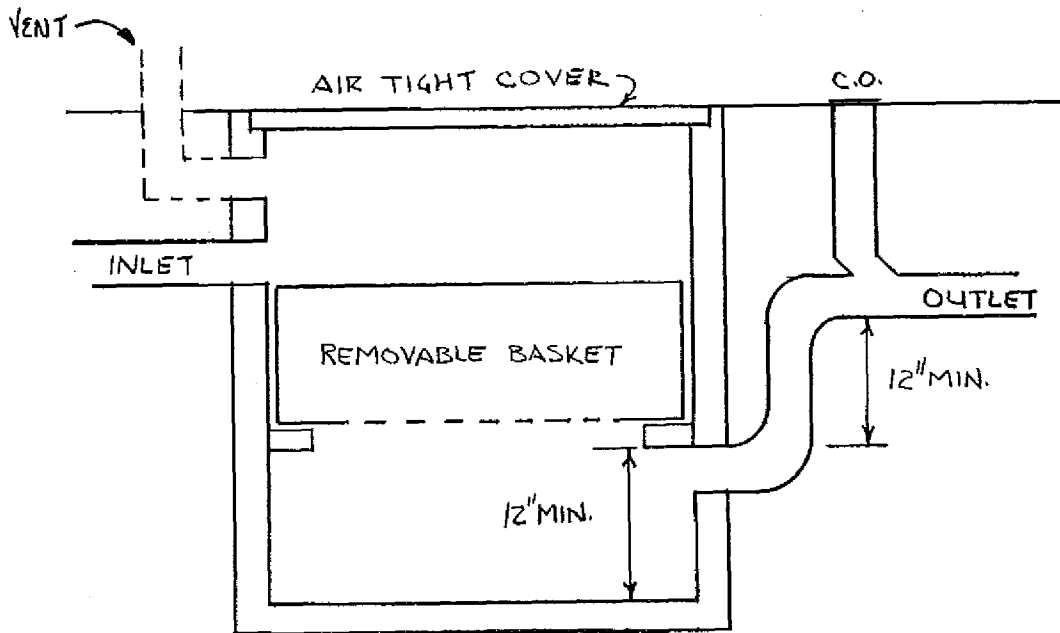

A-82.34 (8)

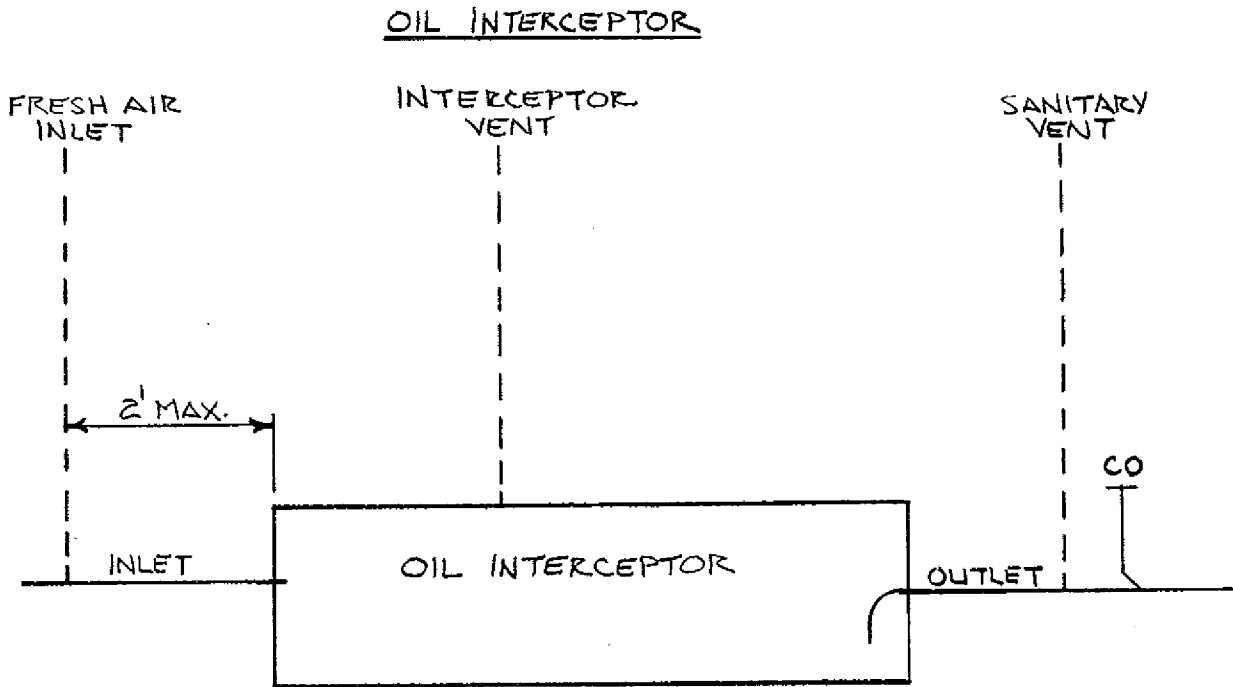

A-82.34 (13)

PLASTER AND HEAVY SOLIDS TRAP

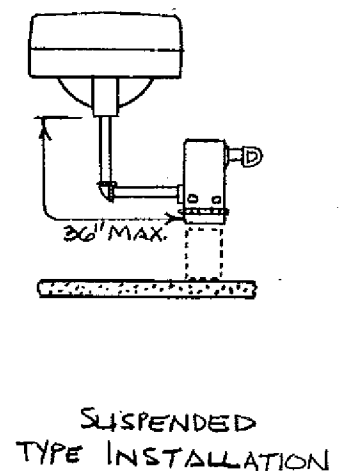
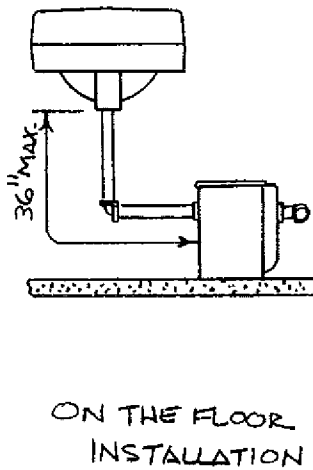
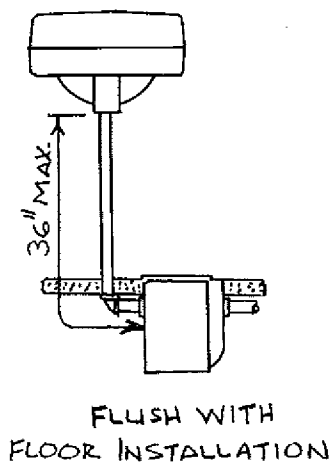

ILHR 82 Appendix

A-82.34 (14) CHEMICAL DILUTION AND NEUTRALIZING BASINS.

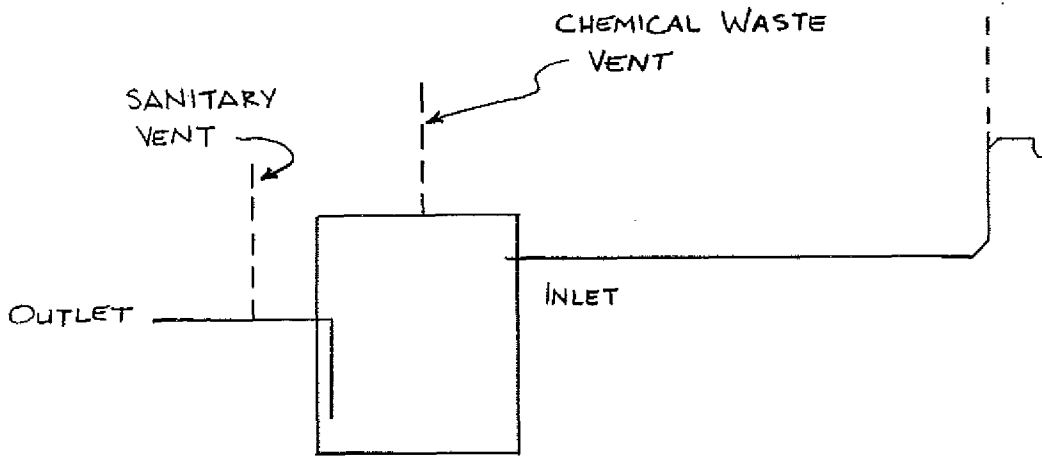
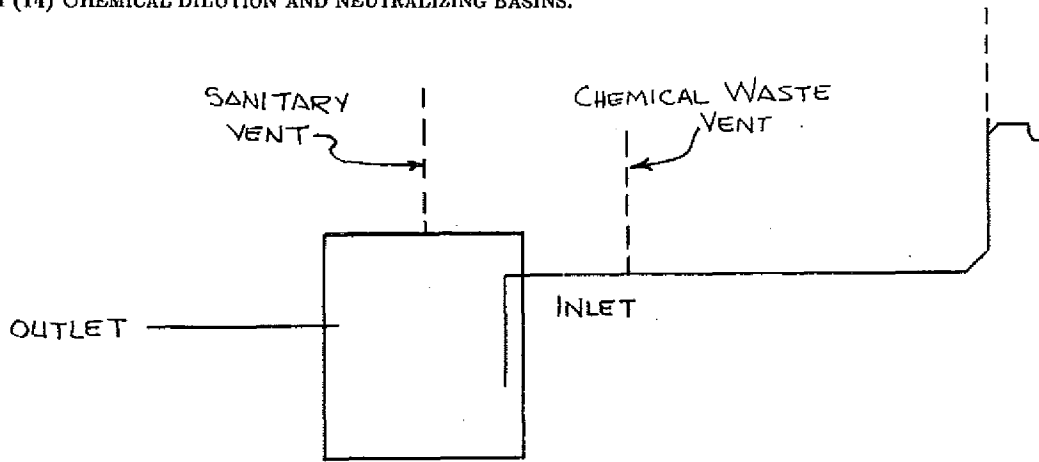

A-82.35 (3)

CLEANOUTS SERVING HORIZONTAL DRAINS WITHIN OR UNDER A BUILDING

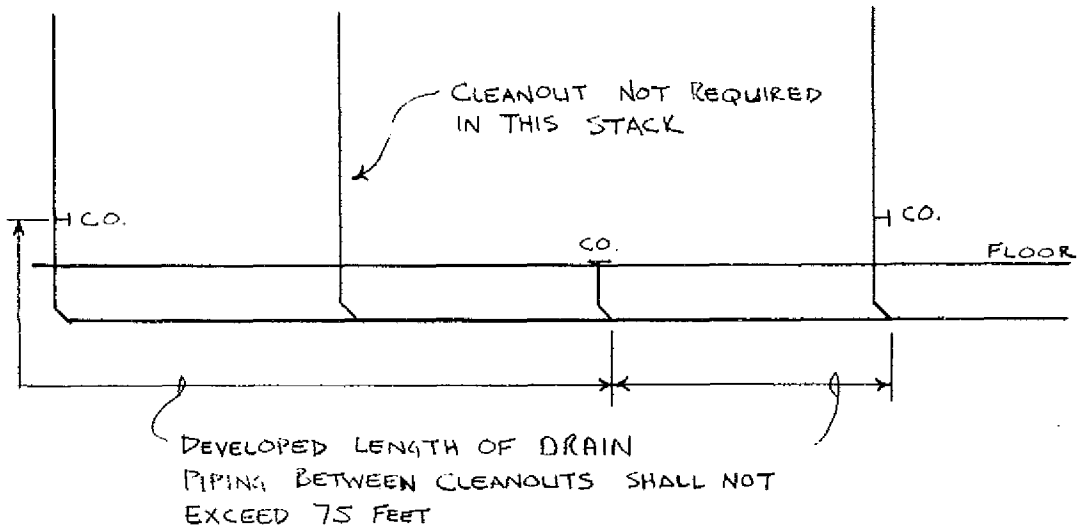

A-82.35 (3) CLEANOUTS SERVING HORIZONTAL DRAINS.

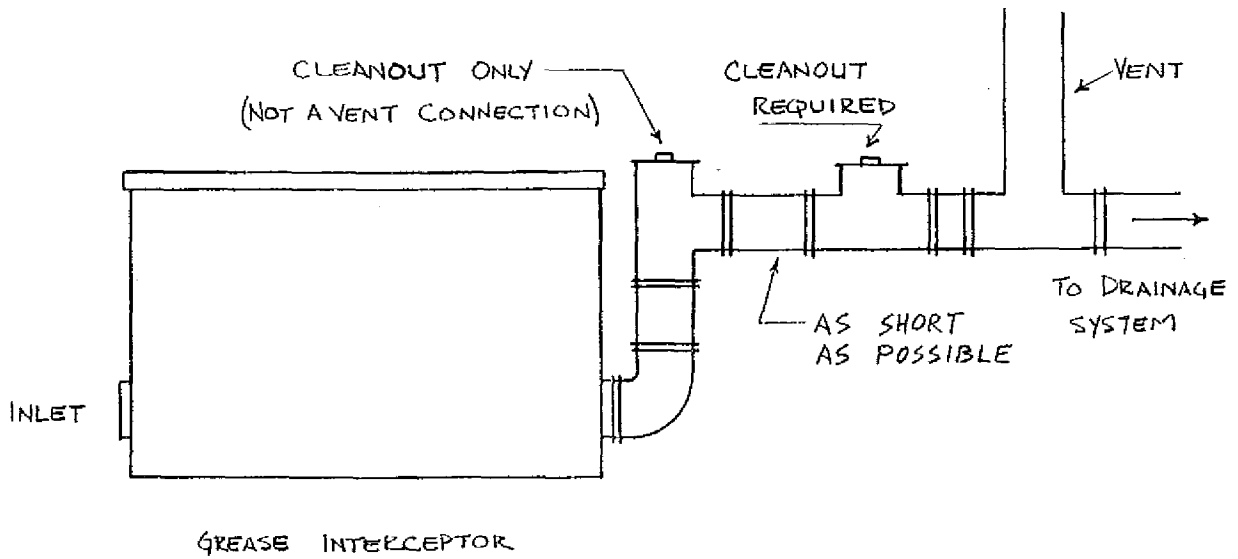
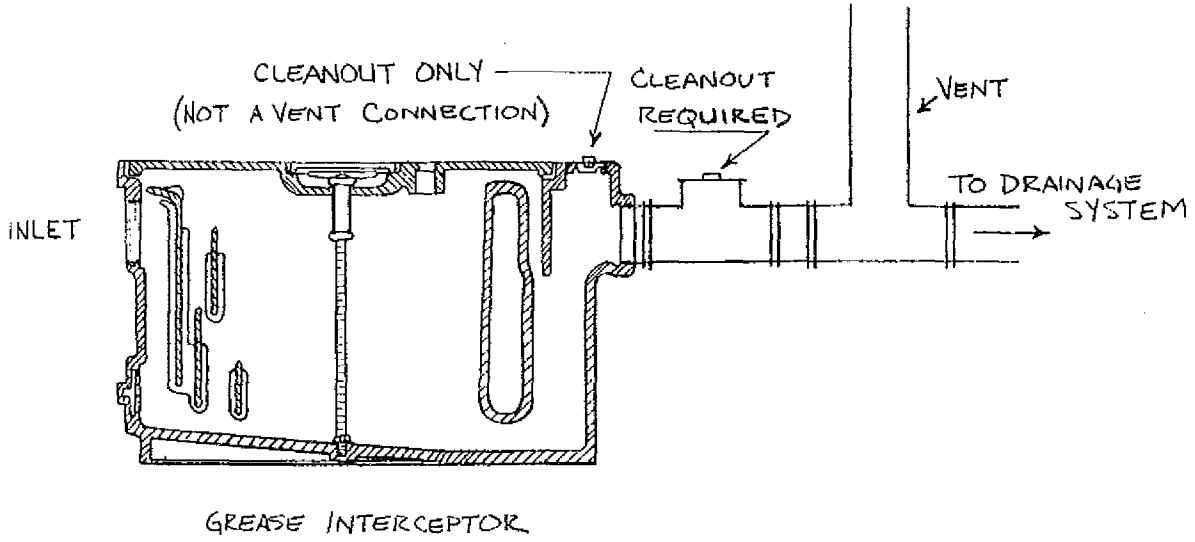

ILHR 82 Appendix

A-82.35 (5) (a) CLEANOUT EXTENSION TO GRADE.

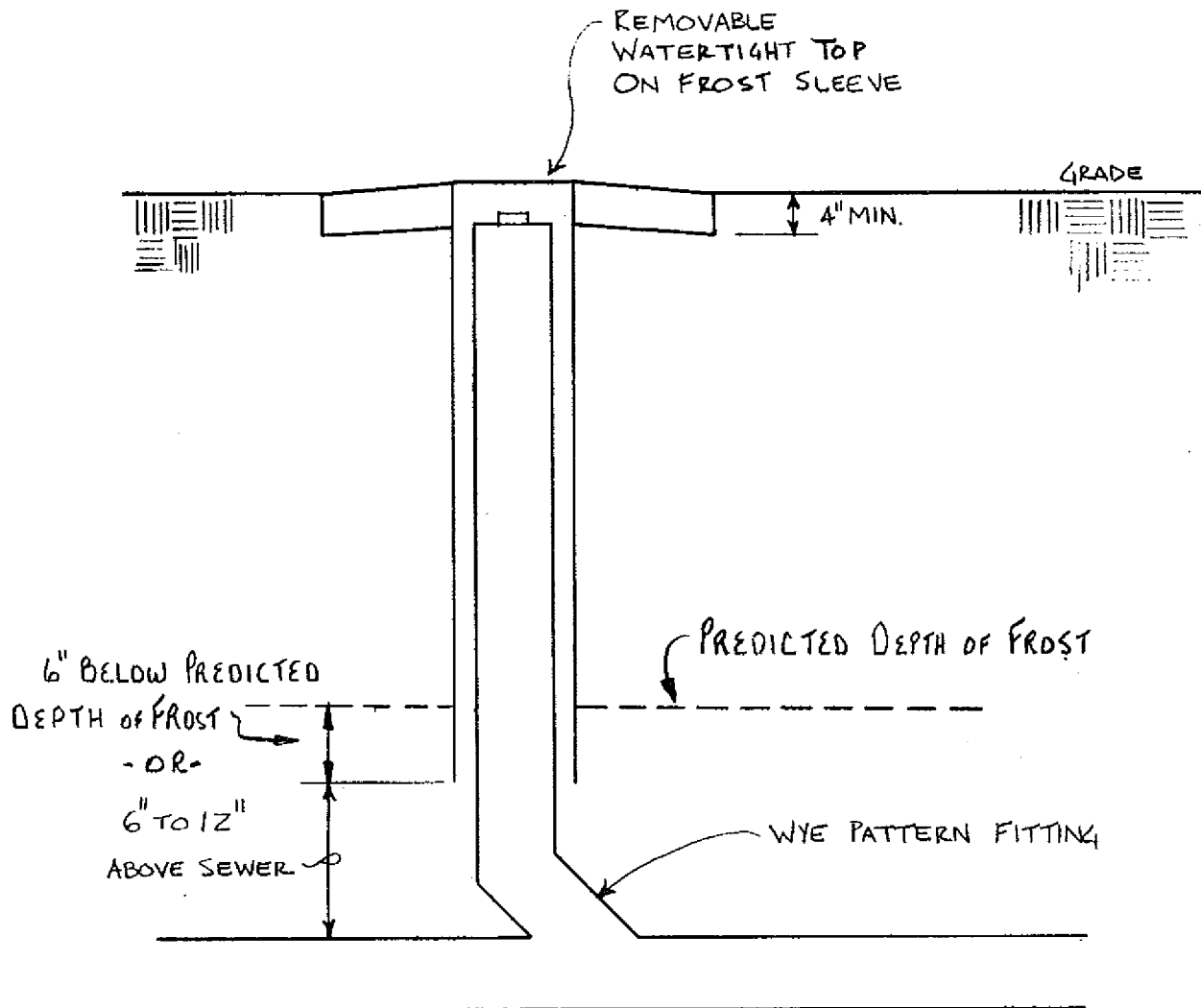
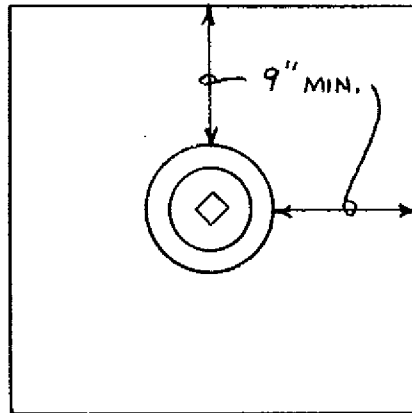

A-82.35 (8)

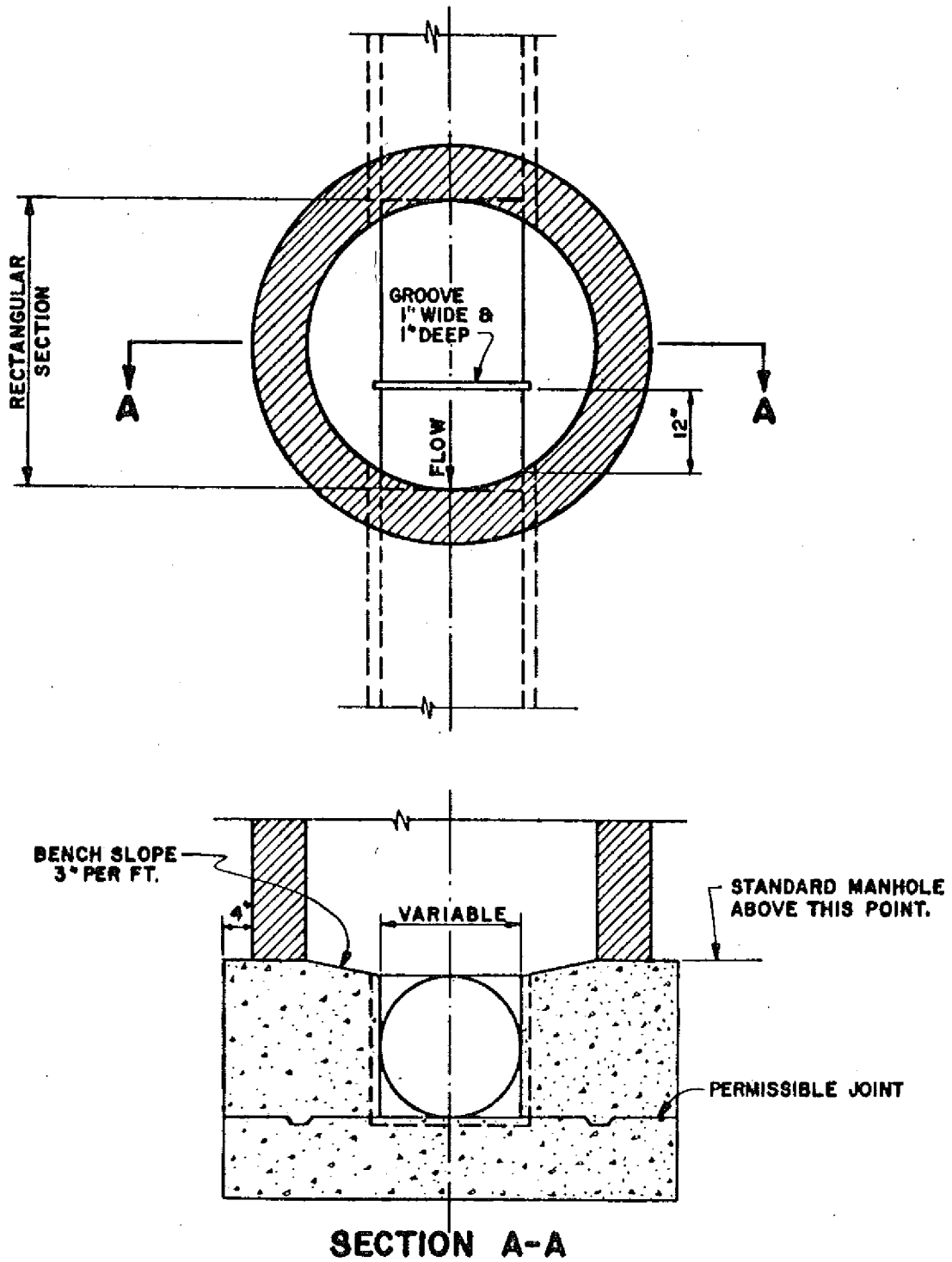

DETAIL OF SAMPLING MANHOLE

ILHR 82 Appendix

A-82.35 (8) (b)

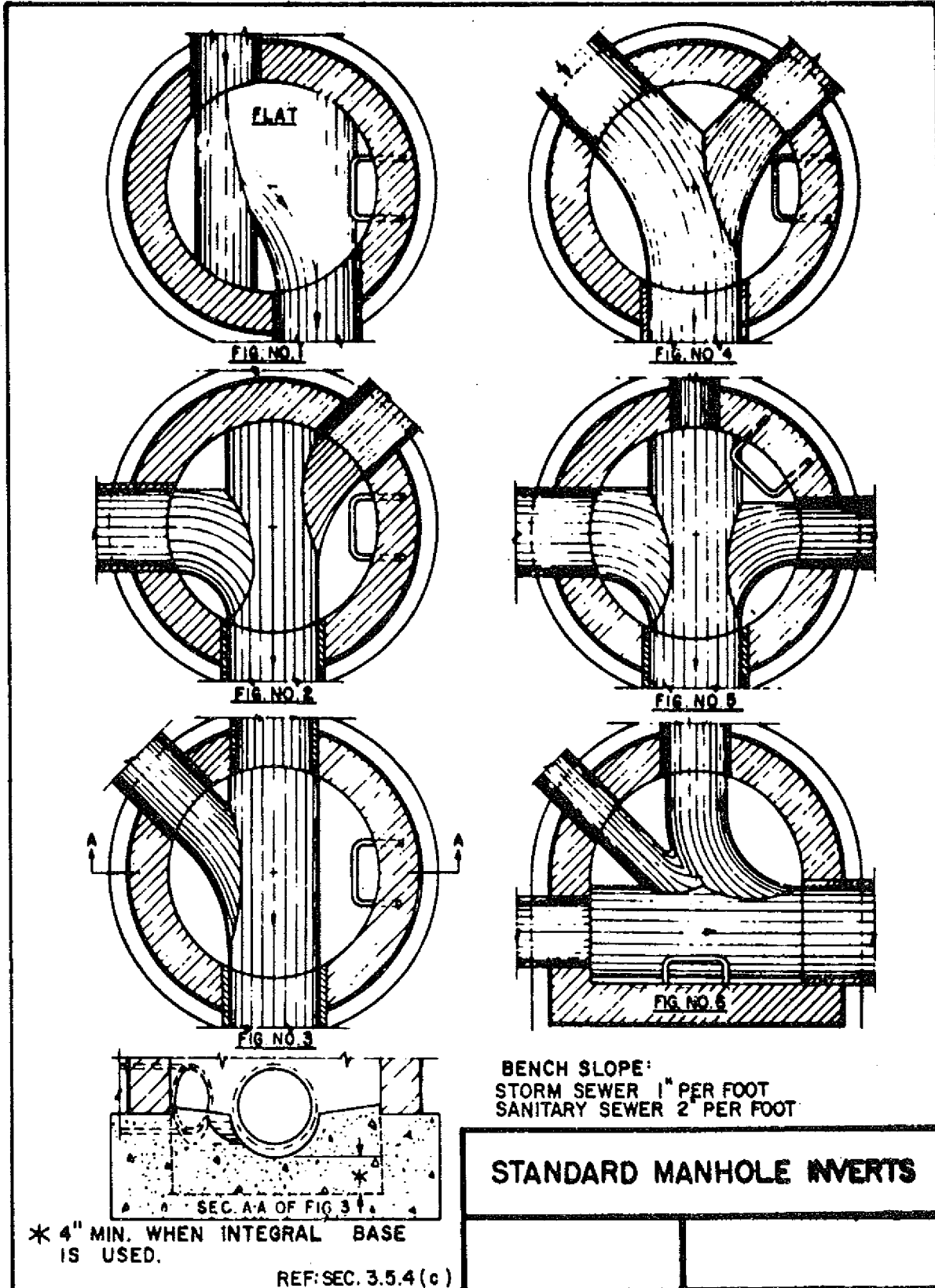

A-82.35 (8) (b)

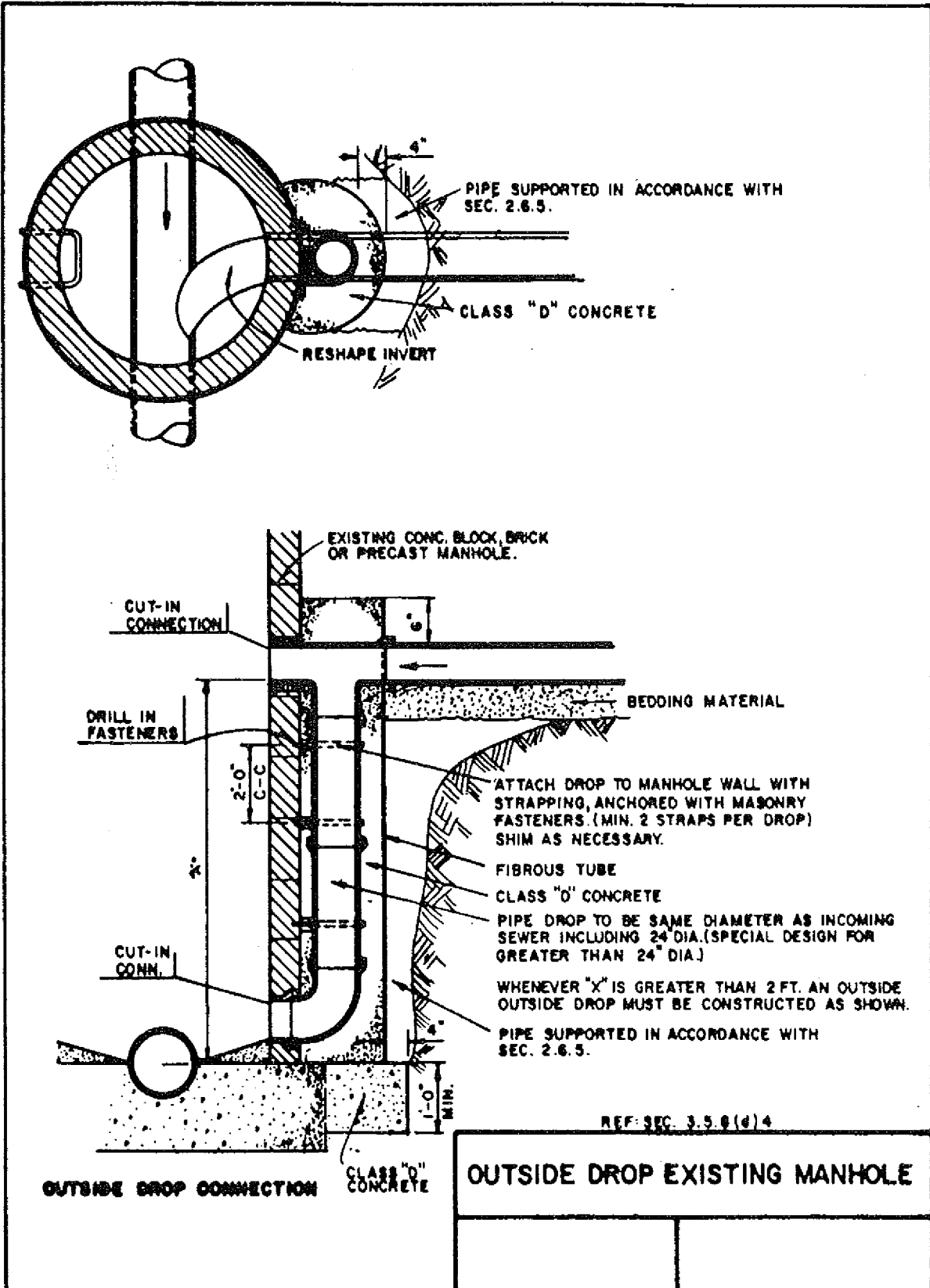

ILHR 82 Appendix

A-82.36 (17) AREA DRAIN INLETS.

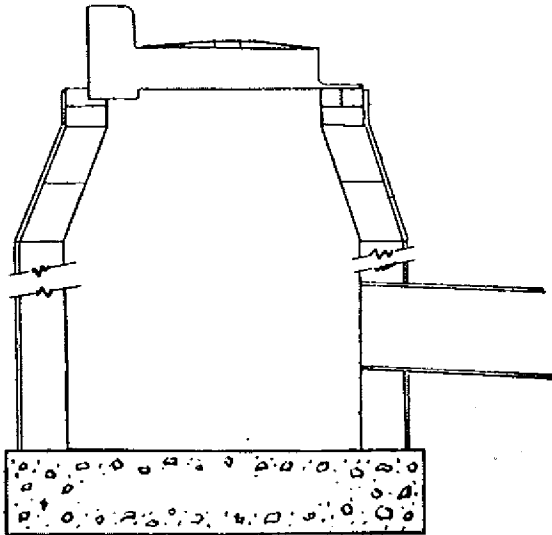

**STANDARD STORM WATER
CATCH BASIN (MASONRY)**

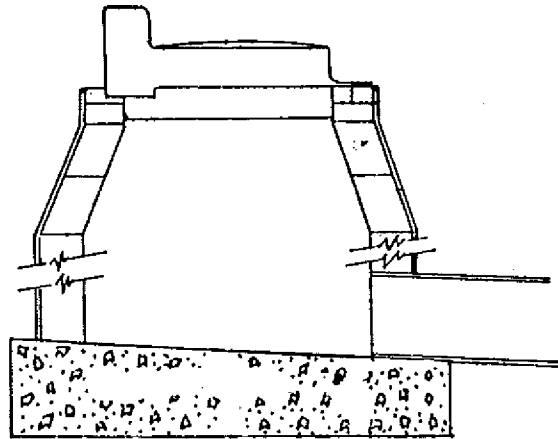

**STANDARD STORM WATER
INLET (MASONRY)**

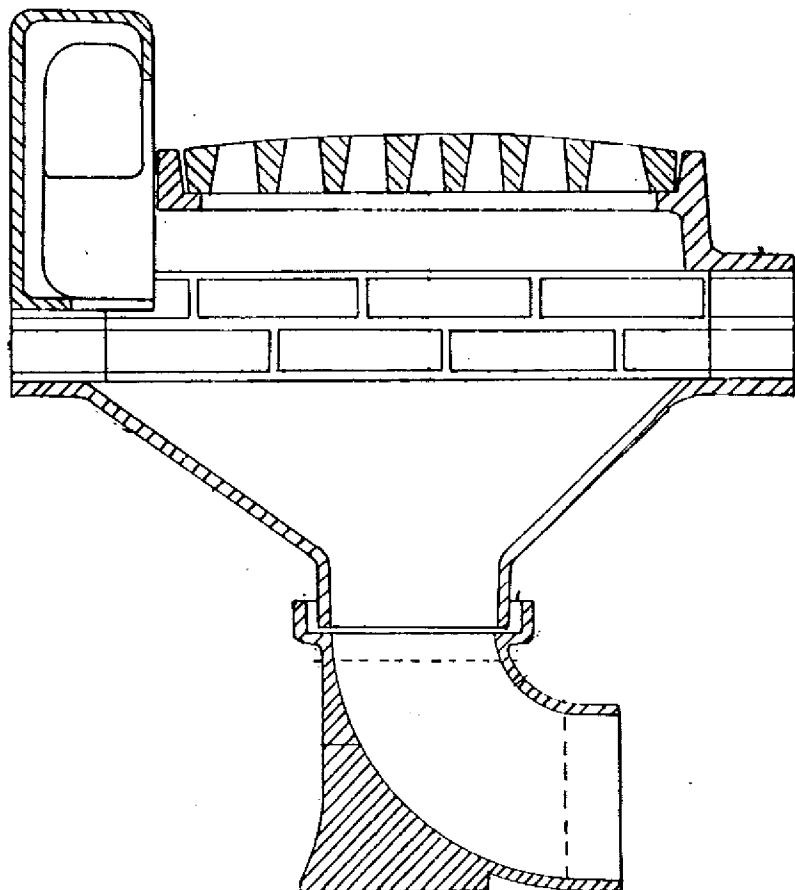

**CAST IRON STORM
WATER INLET**

A-82.51 (3) MOBILE HOME SITES AND PARKS.

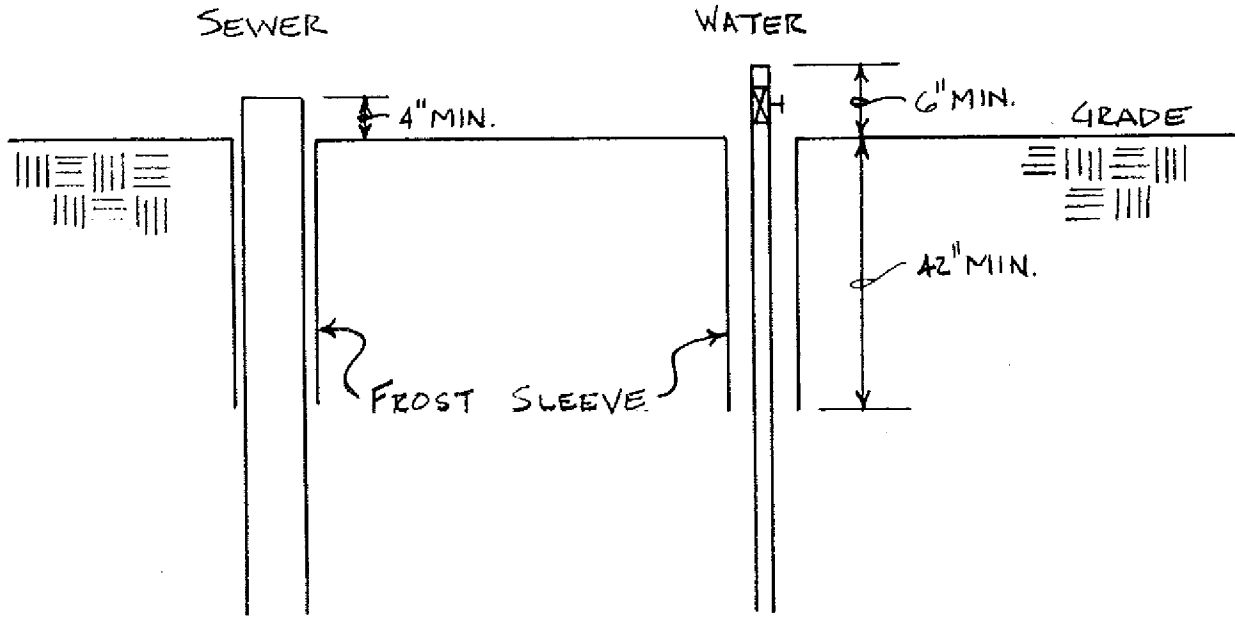

MOBILE HOME BUILDING SEWER AND WATER SERVICE TERMINATIONS

A-82.40 (4)

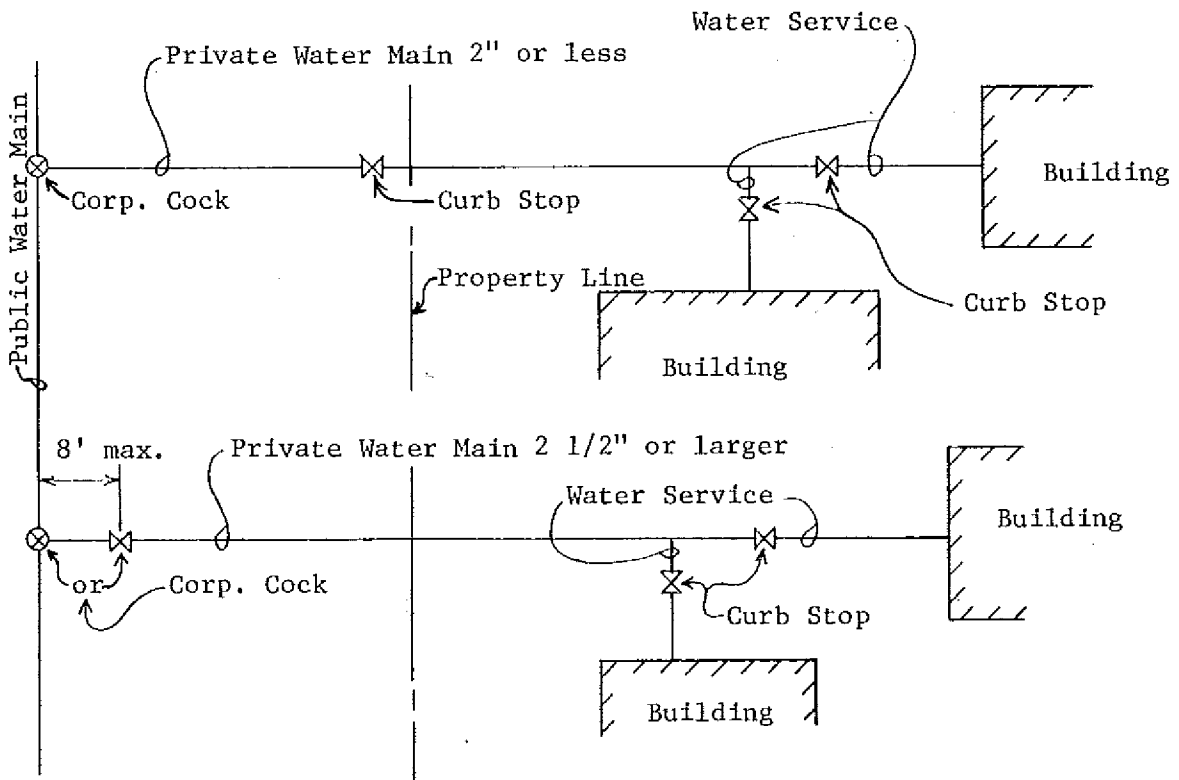

ILHR 82 Appendix

A-82.40 (4) (b)

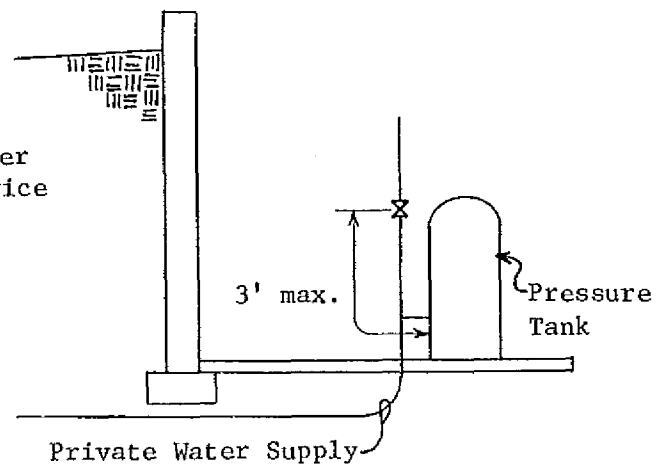
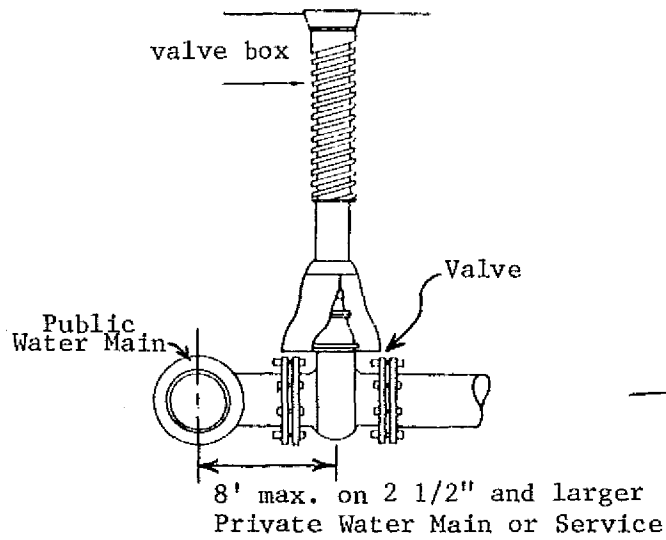
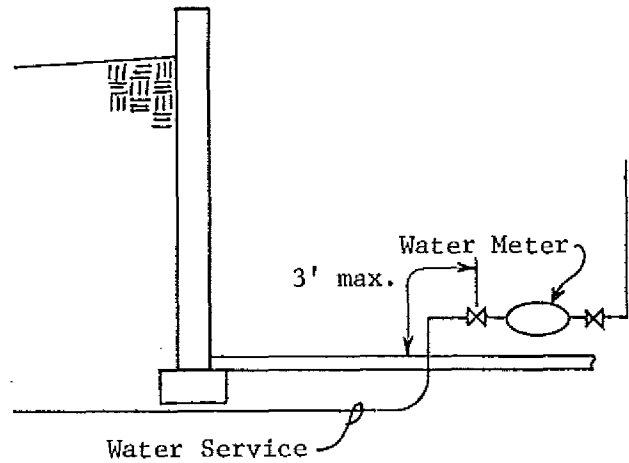
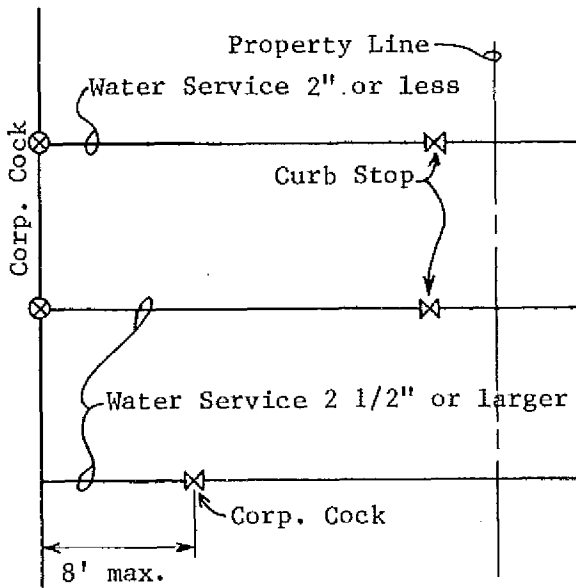

A-82.40 (5) STORAGE TANK AND PIPING INSULATION. The following is a reprint of section ILHR 63.63.

ILHR 63.33 Insulation. (1) STORAGE TANKS. Heat loss from unfired hot water storage tanks shall be limited to 15 Btu per hour per square foot of external tank surface area. The design ambient temperature shall be no higher than 65° F.

(2) PIPING. (a) Except as provided in par. (b), piping heat loss for recirculation systems shall be limited to a maximum of 25 Btu per hour square foot of external pipe insulation surface for aboveground piping and a maximum of 35 Btu per hour per square foot of external pipe insulation for underground piping. Maximum heat loss shall be determined at a ΔT equal to the maximum water temperature minus a design ambient temperature no higher than 65° F.

(b) Conformance to the minimum pipe insulation requirements specified in Table 63.22 shall be deemed as complying with the requirements of this subsection.

A-82.40 (7) (a)

Where equipment such as an instantaneous or tankless water heater, water treatment device, water meter, and backflow preventer is provided in the design, the friction loss in such equipment, corresponding to the GPM demand, should be determined from the manufacturer or other reliable source.

Where a direct fired pressurized tank type water heater is provided in the design, the friction loss for such equipment can be assumed as part of the pressure losses due to flow through piping, fittings, valves and other plumbing appurtenances when the developed length of piping is multiplied by 1.5.

The pressure losses due to flow friction through displacement type cold-water meters may be calculated from Graph A-82.40 (7)-1.

PRESSURE LOSS IN COLD-WATER METERS, DISPLACEMENT TYPE

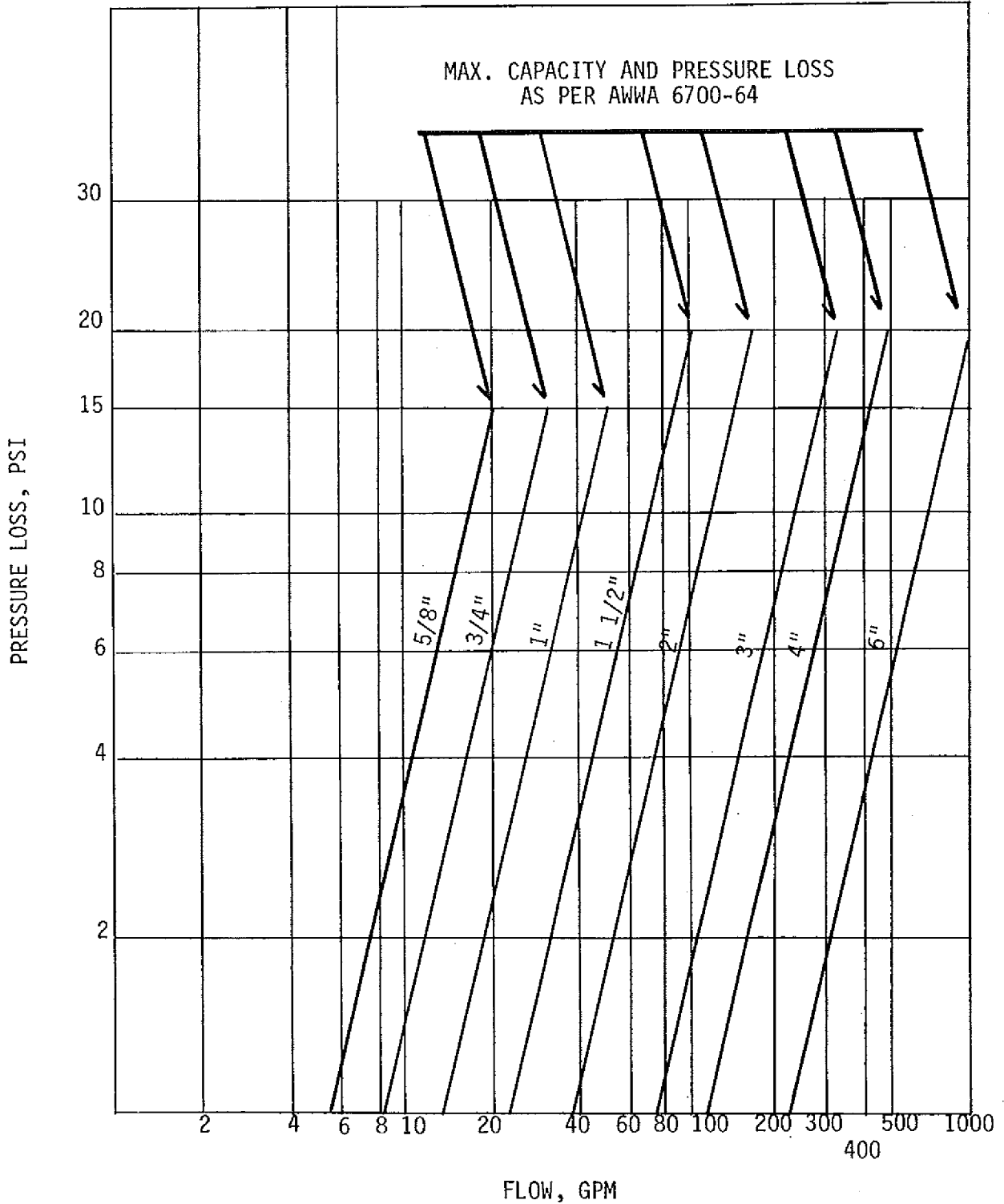

A-82.40 (7) (b)

Graphs A-82.40 (7)-2 to A-82.40 (7)-5 may be used to size private water mains and water services.

Graph A-82.40 (7)-2

Pressure losses due to flow friction
Material: Copper Tube-Type K, ASTM B88

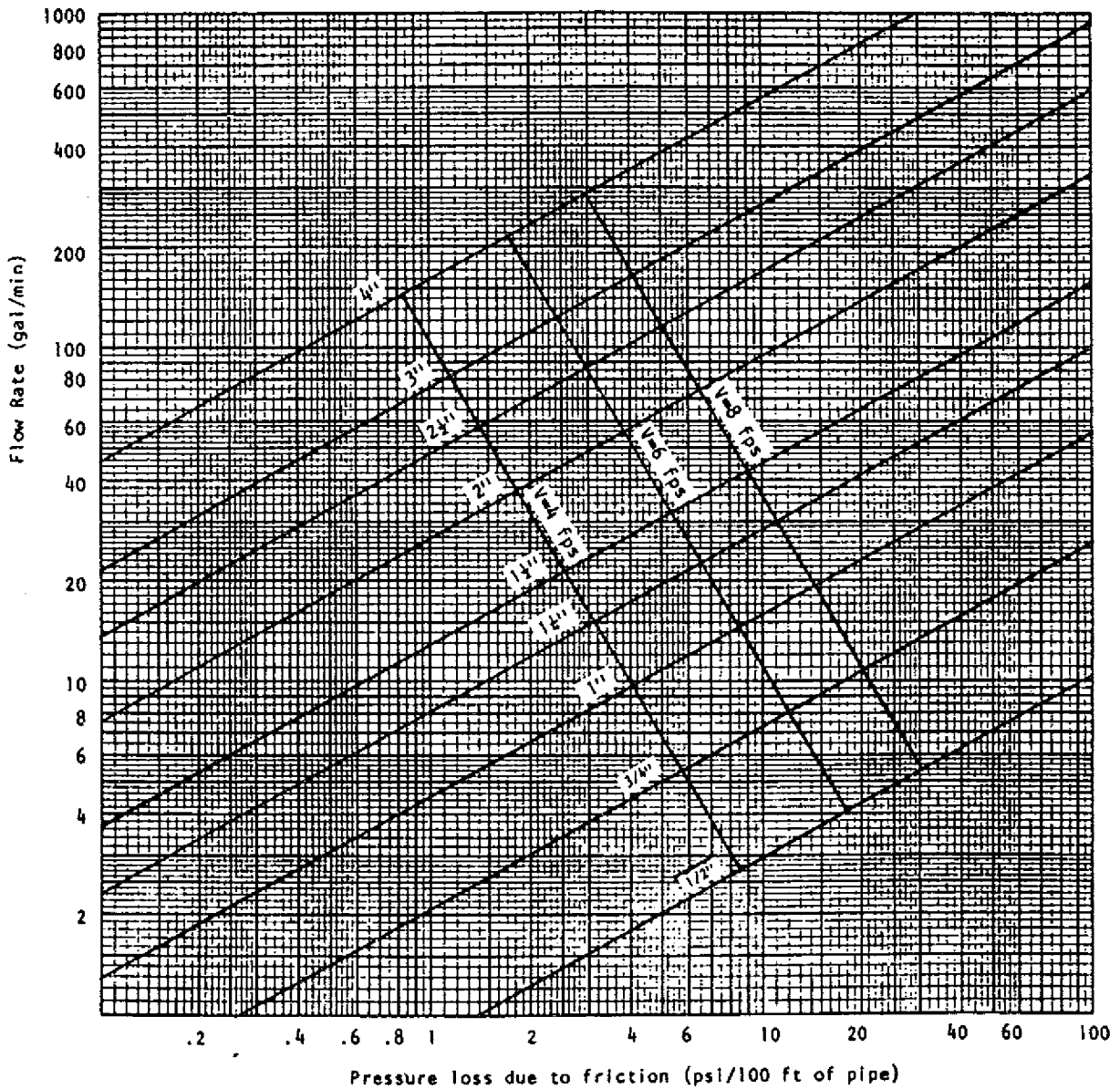

Graph A-82.40 (7)-3

Pressure losses due to flow friction
Material: Copper Tube-Type L, ASTM B88

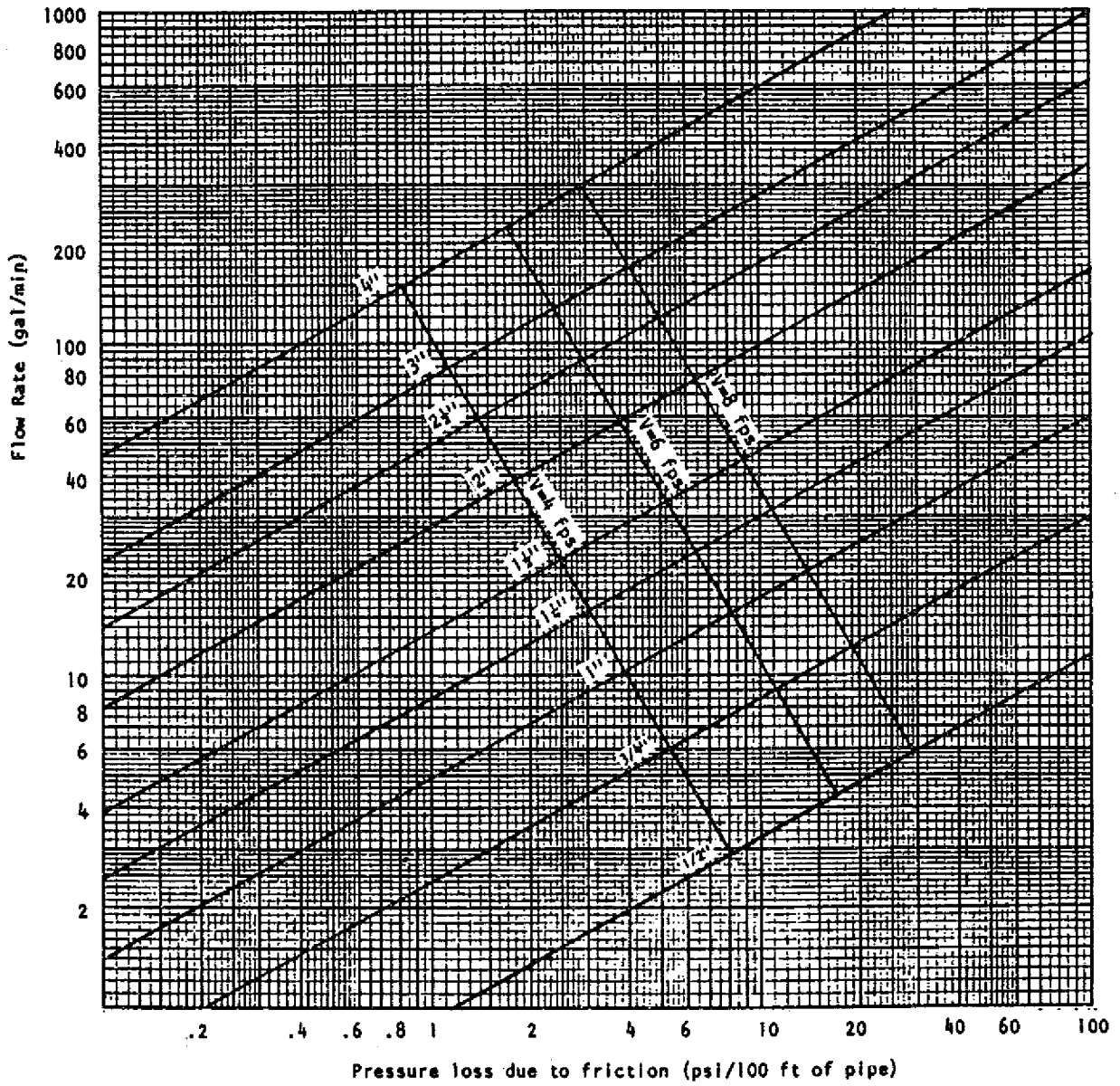

Graph A-82.40 (7)-4

Pressure losses due to flow friction
Material: Galvanized Steel Pipe-Schedule 40, ASTM A53, ASTM A120;
ABS Pipe-Schedule 40; ASTM D1527; or
CPVC Pipe-Schedule 40; ASTM F441; or
PE Pipe-Schedule 40; ASTM D2104; ASTM D2447; or
PVC Pipe-Schedule 40; ASTM D1785;ASTM D2672

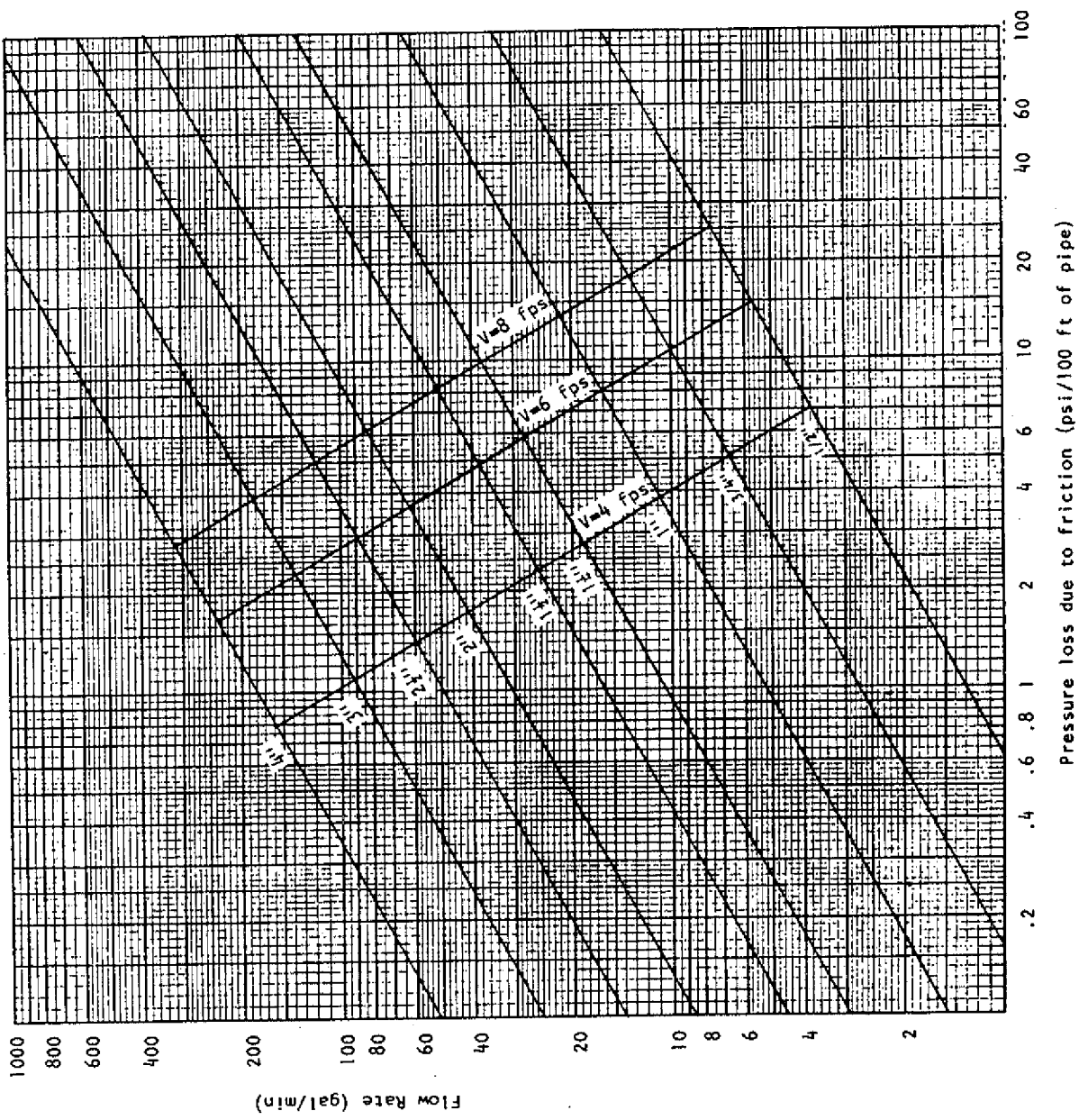

Graph A-82.40 (7)-5

Pressure losses due to flow friction

Material: Polybutylene Tubing, ASTM D3309; or
CPVC Tubing; ASTM D2846

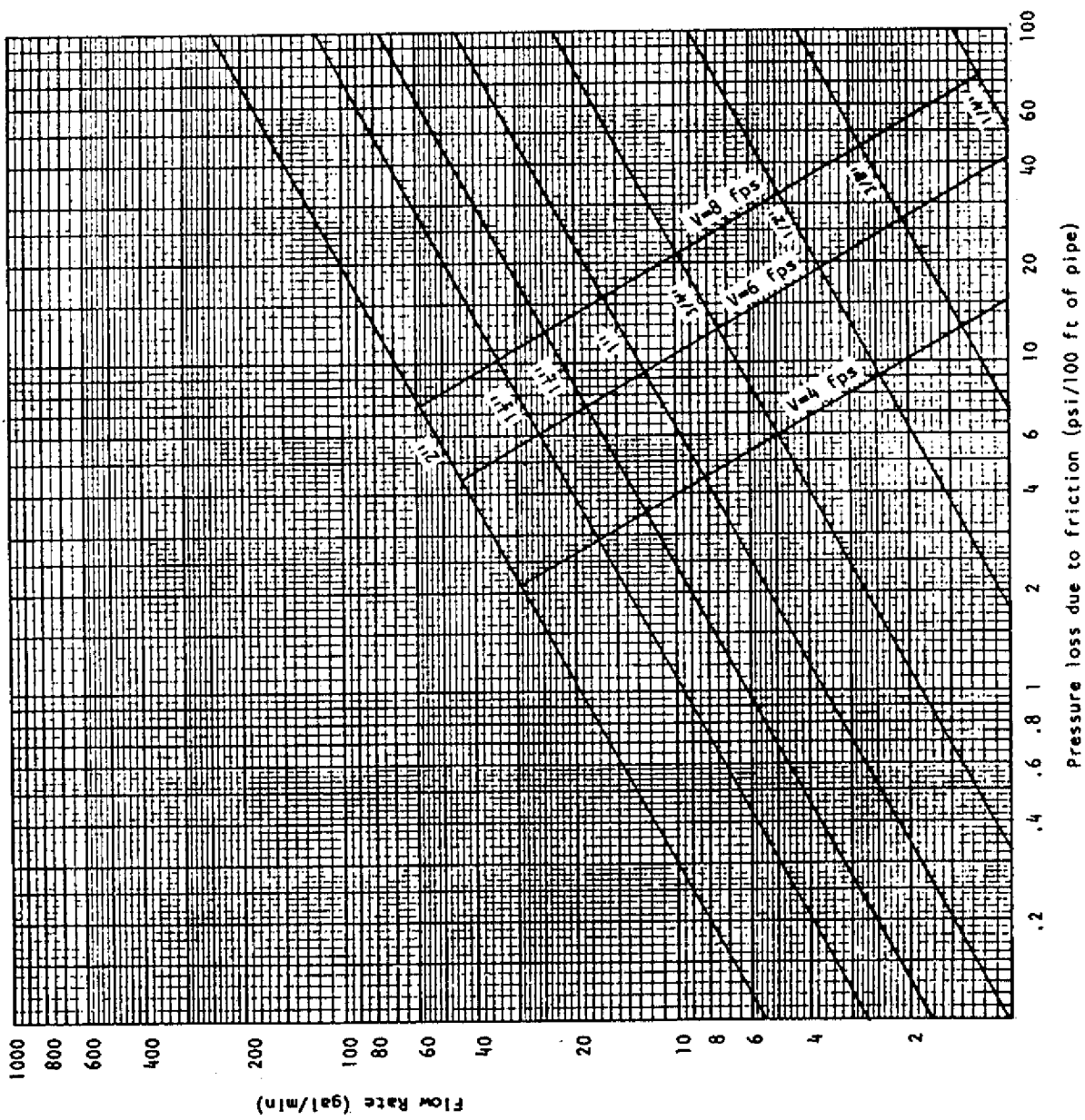

Graph A-82.40 (7)-6

Pressure losses due to flow friction

Material: Crosslinked Polyethylene (PEX) Tubing, ASTM F876

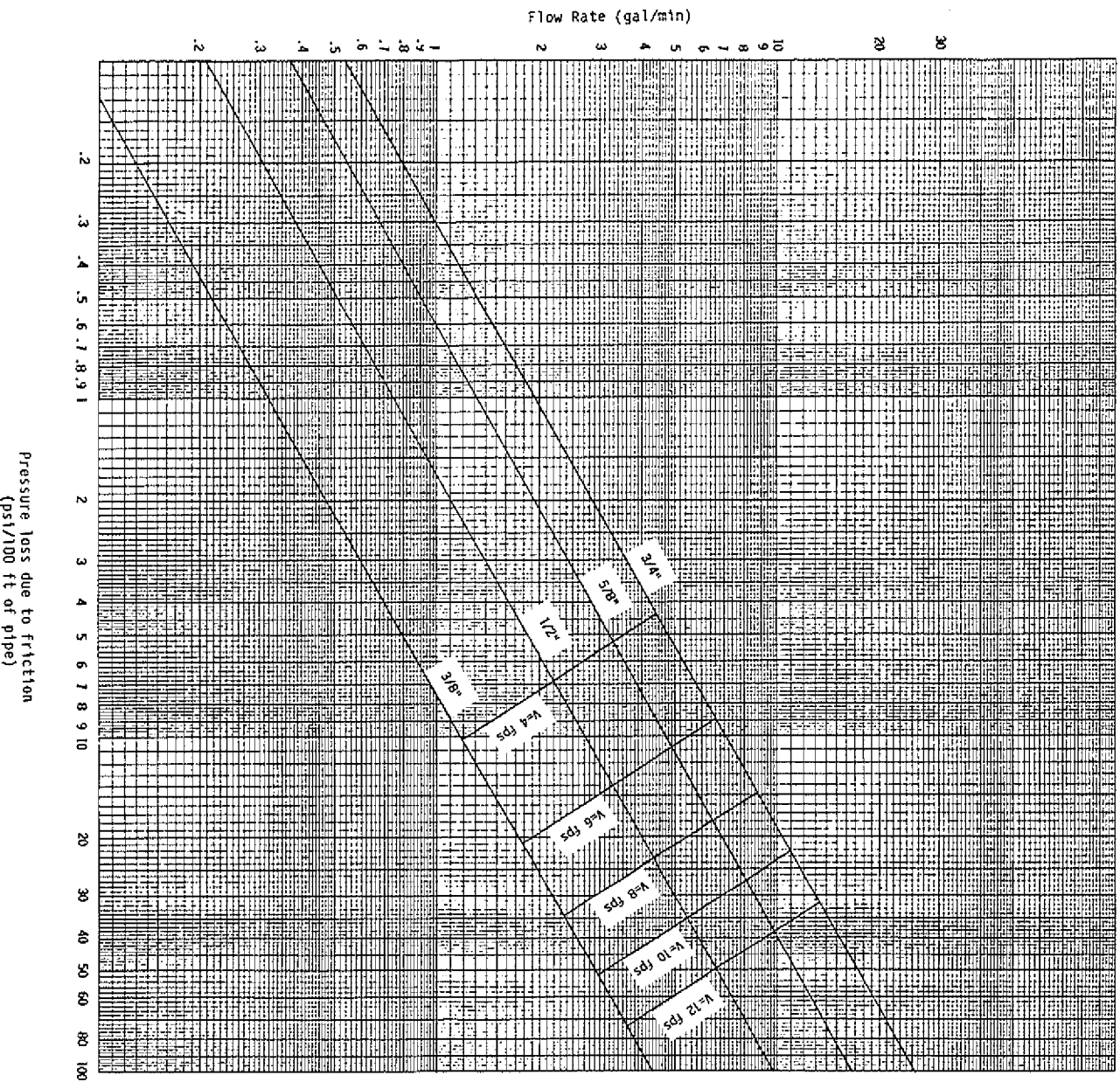

ILHR 82 Appendix

A-82.41 (5) (a) AIR GAP.

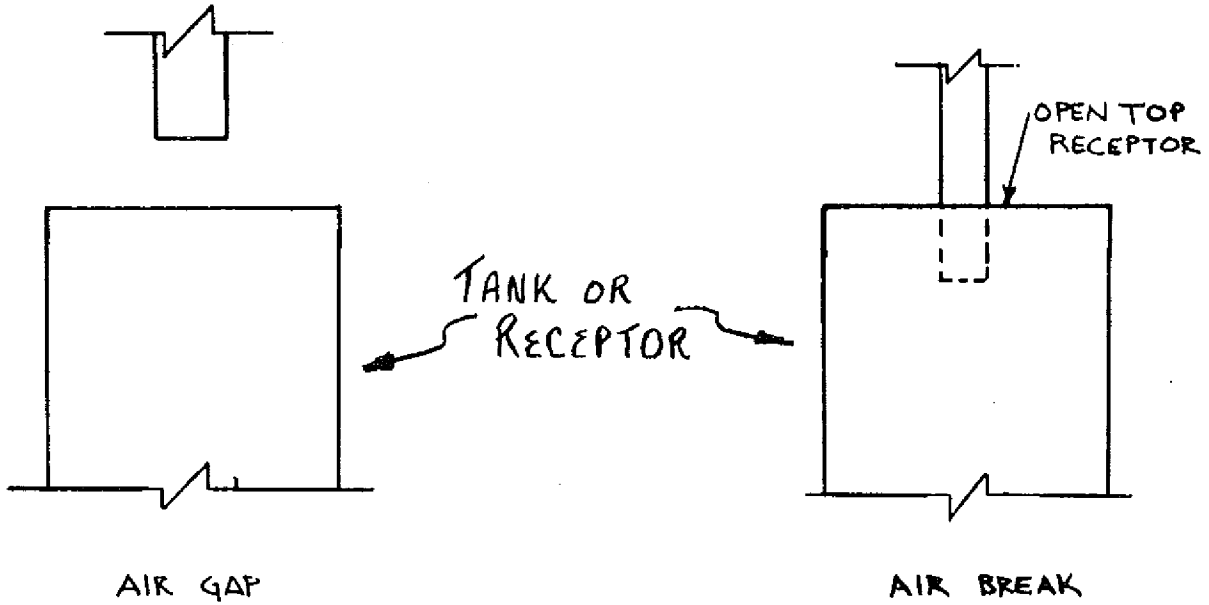

ANSI STANDARD A112.1.2 DESCRIBES OTHER ACCEPTABLE TYPES OF AIR GAPS.