

Chapter Comm 83

PRIVATE SEWAGE SYSTEMS

Comm 83.01	Purpose.
Comm 83.02	Definitions.
Comm 83.03	Approvals and limitations.
Comm 83.035	Petitions for variance.
Comm 83.04	Specific limitations.
Comm 83.05	Local filing requirements.
Comm 83.055	Issuance of building permits.
Comm 83.06	County administration.
Comm 83.07	Plan review—department.
Comm 83.08	Examination of plans and specifications.
Comm 83.09	Site evaluation.
Comm 83.10	Site requirements.

Comm 83.12	Sizing soil absorption systems.
Comm 83.13	Installation—conventional soil absorption systems.
Comm 83.14	Pressure distribution systems.
Comm 83.15	Septic tanks and other treatment tanks.
Comm 83.16	Maintenance and sludge disposal.
Comm 83.17	Chemical restoration.
Comm 83.18	Holding tanks.
Comm 83.19	Inspections.
Comm 83.20	Materials.
Comm 83.21	Building sewers and drains.
Comm 83.23	Mound systems.

Note: Chapter H 63 was created as an emergency rule effective 6-21-80; chapter H 63 as it existed on June 30, 1983 was renumbered to chapter ILHR 83. Chapter ILHR 83 was renumbered Chapter Comm 83 under s. 13.93 (2m) (b) 1., Stats., and corrections made under s. 13.93 (2m) (b) 6. and 7., Stats., Register, February, 1997, No. 494.

Comm 83.01 Purpose. (1) **GENERAL.** The underlying principles of this chapter as authorized in s. 145.02 (2), Stats., are basic goals in environmental health and safety accomplished by proper siting, design, installation, inspection, and maintenance of private sewage systems. The prerequisites necessary for the essential protection of the health of the public and the environment are the same everywhere. As unforeseen situations arise which are not specifically covered in this chapter the basic principles enumerated in this section shall serve to define intent.

Note: All forms required for compliance with this chapter are available from the local county sanitary permit office and are supplied by the department from the Safety and Buildings Division, P. O. Box 7969, Madison, WI 53707.

(2) **BASIC PRINCIPLES.** (a) **Need.** Every building intended for human habitation or occupancy shall be provided with a properly functioning system for treatment and disposal of domestic waste.

(b) **Public sewers.** Every building intended for human habitation or occupancy on land abutting a street, right-of-way, or easement in which there is a public sewer, or on land deemed accessible to public sewer, shall have an individual connection to the public sewer and the private sewage system serving such building shall be properly abandoned.

(c) **Discharges prohibited.** Every private sewage system shall be designed, located and constructed to prevent any discharge of sewage or partially treated sewage into drain tiles, onto the ground surface, into the structure served, into the surface waters of the state or into the groundwater of the state including zones of seasonal soil saturation.

(d) **Maintenance.** Every private sewage system shall be adequately maintained.

(e) **Nuisance.** Every private sewage system shall be designed, located and constructed so as not to create a nuisance.

(f) **Sizing.** Every private sewage system shall be designed and constructed to adequately dispose of all the wastewater generated in the structure or facility it is serving.

History: Cr. Register, December, 1980, No. 300, eff. 1-1-81; renum. from H 63.01, Register, June, 1983, No. 330, eff. 7-1-83.

Comm 83.02 Definitions. For the purpose of this chapter, the following definitions shall apply. The dictionary meaning shall apply for all other words.

(1) "Aggregate" means washed graded hard rock that has been washed with water under pressure over a screen during or after grading to remove fine material and with a hardness value of 3 or greater on Moh's Scale of Hardness. Aggregate that can scratch a copper penny without leaving any residual rock material

on the coin would have a hardness of 3 or more on Moh's Scale of Hardness.

(3) "Approved" means approved or accepted by the department.

(4) "Bedrock" means the rocks that underlie soil material or are at the earth's surface. Bedrock is encountered when the weathered in-place consolidated material, larger than 2 mm in size, is greater than 50% by volume.

(5) "Building" means a structure having walls and a roof erected or set upon an individual foundation or slab-constructed base designed or used for the housing, shelter, enclosure or support of persons, animals or property of any kind. A mobile home is included in this definition. Each structure abutting another structure which does not have an ingress-egress doorway through the basement foundation walls, or structures with separate exterior or exterior abutting walls, or public use structures separated by an unpierced firewall, shall be considered as a separate or individual building.

(6) "Cesspool" means a covered excavation in the ground which receives sewage or other organic wastes from a drainage system, and so designed as to retain the organic matter and solids, permitting the liquids to seep into the soil cavities.

(7) "Cleanout" means a plug or cover made of material approved by the department joined by means of a screw thread to an opening in a pipe, which can be removed for the purpose of cleaning or examining the interior of the pipe.

(8) "Clear water wastes" means cooling water and condensate drainage from refrigeration compressors and air-conditioning equipment, water used for equipment chilling purposes, liquid having no impurities or where impurities have been reduced below a minimum concentration considered harmful, and cooled condensate from steam heating systems or other equipment.

(9) "Color" means the moist color of the soil based on Munsell soil color charts.

(11) "Conventional soil absorption system" means a system that employs gravity flow from the septic or other treatment tank and applies effluent to the soil through the use of a seepage trench, bed or pit. The distribution piping is 4 inch diameter pipe.

(12) "County" means the local government unit responsible for the regulation of private sewage systems. County government is the local governmental unit responsible except that towns, villages and cities are the responsible unit of government in any county that has a population in excess of 500,000.

(13) "Department" means the department of commerce.

(14) "Detailed soil map" means a map prepared by or for a state or federal agency participating in the national cooperative soil survey showing soil series, type and phases at a scale of not

more than 2,000 feet to the inch and includes related explanatory information.

(15) "Dosing soil absorption system" means a system that employs a pump or automatic siphon to elevate or distribute effluent to the soil through the use of a seepage trench or bed. Distribution piping in seepage trenches or beds shall be 4 inch perforated pipe approved by the department.

(16) "Dwelling unit" means one or more rooms with provisions for living, sanitary and sleeping facilities which are used or intended to be used by one person or by 2 or more persons maintaining a common household.

(17) "Effluent" means liquid discharged from a septic or other treatment tank.

(18) "Failing private sewage system" has the meaning as given in s. 145.245 (4), Stats.

Note: Section 145.245 (4), Stats., reads: "A failing private sewage system is one which causes or results in any of the following conditions: (a) the discharge of sewage into surface water or groundwater; (b) the introduction of sewage into zones of saturation which adversely affects the operation of a private sewage systems; (c) the discharge of sewage to a drain tile or into zones of bedrock; (d) the discharge of sewage to the surface of the ground; (e) the failure to accept sewage discharges and back up of sewage into the structure served by the private sewage system."

(19) "Farm" means a parcel of 35 or more acres of contiguous land which is devoted primarily to agricultural use, as defined in s. 91.01 (1) and (5), Stats., which during the year preceding application for a mound produced gross farm profits as defined in s. 71.58 (4), Stats., of not less than \$6,000 or which during the 3 years preceding application produced gross farm profits, as defined in s. 71.58 (4), Stats., of not less than \$18,000.

(20) "Flood fringe" means that portion of a flood plain which is outside of the floodway and which is covered by flood waters during any regional floods. It is generally associated with standing water rather than rapidly flowing water.

(21) "Flood plain" means the land which has been or may be covered by flood water during regional floods. The flood plain includes the floodway and the flood fringe.

(22) "Floodway" means the channel of a river or stream and those portions of the flood plain adjoining the channel which carry and discharge flood water or flood flows during the regional floods.

(23) "Grease interceptor" means a watertight tank which is installed underground for the collection and retention of grease from cooking or food processing and which is accessible for periodic removal of the contents.

(24) "High groundwater" means zones of soil saturation which include: Perched water tables, shallow regional groundwater tables or aquifers, or zones that are seasonally, periodically or permanently saturated.

(25) "High water level" means the highest known flood water elevation of any lake, stream, pond or flowage or the regional flood elevation established by a state or federal agency.

(26) "Holding tank" means an approved watertight receptacle for the collection and holding of sewage.

(27) "Horizontal reference point" means a stationary, easily identifiable point to which horizontal dimensions can be related.

(28) "Industrial waste" means liquid wastes which result from processes employed in industrial establishments.

(29) "Legal description" means an accurate Metes and Bounds description, a lot and block number in a recorded subdivision, a recorded assessor's plat or a public land survey description to the nearest 40 acres.

(29m) "Local station" means a National Weather Service (NWS) precipitation station or other precipitation station accepted by the department as collecting precipitation data in accordance with NWS methods.

(30) "Manhole" means an opening of sufficient size to permit a person to gain access to a sewer or any portion of a plumbing system.

(31) "Mobile home" means a transportable structure mounted on a chassis and designed to be used with or without a permanent foundation as a dwelling unit. The phrase "without a permanent foundation" indicates that the support system is constructed with the intent that the mobile home thereon may be moved from time to time at the convenience of the owner. See ss. 218.10 (2) and 340.01 (29), Stats.

(32) "Mobile home park" means any plot or plots of ground owned by a person, state or local government upon which 2 or more units, occupied for dwelling or sleeping purposes regardless of mobile home ownership, are located, and whether or not a charge is made for such accommodation. See s. 66.058 (1) (i), Stats.

(33) "Nuisance" means any source of filth, odor or probable cause of sickness pursuant to the provisions of s. 146.14, 1991 Stats.

Note: 1993 Wis. Act 27 repealed s. 146.14, Stats., and replaced with the concept of "human health hazard."

(34) "Percolation test" means the method specified in s. Comm 83.09 (5) of testing absorption qualities of the soil.

(35) "Permeability" means the ease with which liquids move through the soil. One of the soil qualities listed in soil survey reports.

(36) "Pipe diameters" means the inside diameter.

(37) "Plumbing system" means a system as defined in s. 145.01 (10), Stats.

(38) "Potable water" means water which is satisfactory for human consumption, hygiene and culinary use and meets the requirements of the state administrative authority having jurisdiction.

(39) "Pressure distribution system" means a soil absorption system that employs a pump or automatic siphon and small diameter distribution piping with small diameter perforations to introduce effluent into the soil. Plan review and departmental approval is required for each system of this type.

(40) Private sewage system is defined in s. 145.01 (12), Stats.

(41) "Private residence" means a one- or 2-family building or dwelling. See dwelling unit.

(42) "Privy" means a structure that is not connected to a plumbing system which is used by persons for the deposition of human body wastes.

(43) "Public building" means any structure, including exterior parts of such building, such as a porch, exterior platform or steps providing means of ingress or egress, used in whole or in part as a place of resort, assemblage, lodging, trade, traffic, occupancy or use by the public, or by 3 or more tenants in accord with s. 101.01 (12), Stats.

(44) "Reservoir" means a watertight receptacle basin or vault constructed above the ground surface or underground for the storage of potable water.

(45) "Public garage" means a building or part of a building used for the storage of land, air or water vehicles by 3 or more persons not of the same family or habitation.

(46) "Regional flood" means as defined in ch. NR 116, Wis. Adm. Code.

(47) "Regional flood elevation" means as defined in ch. NR 116, Wis. Adm. Code.

(48) "Seepage bed" means an excavated area larger than 5 feet in width which contains a bedding of aggregate and has more than one distribution line.

(49) "Seepage pit" means an underground receptacle so constructed as to permit disposal of effluent or clear wastes by soil absorption through its floor and walls.

(50) "Seepage trench" means an area excavated one to 5 feet in width which contains a bedding of aggregate and a single distribution line.

(51) "Septic tank" means a tank which receives and partially treats sewage through processes of sedimentation, oxygenation, flotation and bacterial action so as to separate solids from the liquid in the sewage and discharges the liquid to a soil absorption system.

(52) "Sewage" means the liquid and water carried wastes created in and to be conducted away from residences, industrial establishments and public buildings.

(53) "Soil" means the unconsolidated material over bedrock.

(54) "Soil boring" means an observation pit dug by hand or backhoe, a hole dug by augering or a soil core taken intact and undisturbed with a probe.

(54m) "Soil consistence" means the cohesion among soil particles and the adhesion of soil to other substances.

(54q) "Soil horizon" means any layer of soil or soil material occurring approximately parallel to the land surface and differing from adjacent layers in physical, chemical, and biological properties or characteristics, including but not limited to color, texture, structure and consistency. Some types of soil horizons include:

(a) The "A" horizon means a mineral horizon that formed at the surface and is characterized by an accumulation of organic matter intimately mixed with the mineral fraction;

(b) The "B" horizon means a mineral horizon that formed below an "A" or "E" horizon and is dominated by concentrations of silicate clay, iron, aluminum, gypsum or silica; and

(c) The "E" horizon means a mineral horizon in which the main feature is the loss of silicate clay, iron, aluminum or a combination of these leaving a concentration of sand and silt particles of quartz or other resistant minerals.

(55) "Soil mottles" means spots or streaks of contrasting soil colors usually caused by soil saturation for some period of a normal year.

Note: Grayish colored mottles are called low chroma; reddish brown, red or yellow mottles are called high chroma.

(56) "Soil saturation" means the state when all the pores in a soil are filled with water. Water will flow from saturated soil into a bore hole.

(56m) "Soil structure" means the combination or arrangement of individual soil particles into definable aggregates or peds, which are characterized and classified on the basis of size, shape and degree of distinctness.

(56n) "Soil texture" means the relative proportions of the various soil separates in a soil, as specified in the United States department of agriculture system.

(57) "Topsoil" means the undisturbed surface horizon of a soil often characterized by a black or dark grayish brown color due to a higher content of organic matter.

(58) "Vent cap" means an approved appurtenance used for covering the vent terminal of an effluent disposal system to avoid closure by mischief or debris and still permit circulation of air within the system.

(59) "Vertical elevation reference point" means an easily identifiable stationary point or object of constant elevation for establishing the relative elevation of percolation tests, soil borings and other locations.

(60) "Water service" means a pipe extended from the water main or private pumping system or other supply source with or without lateral extensions to the building, structure or other system to be served.

(61) "Workmanship" means work of such character that will fully secure the results sought in all the sections of this chapter as intended for the safety, welfare and health protection of all individuals.

(62) "Watercourse" means a stream usually flowing in a particular direction, though it need not flow continually, it may sometimes be dry. It must flow in a definite channel, having a bed, sides or banks, and usually discharges itself into some other stream or body of water. It must be something more than a mere surface drainage over the entire face of a tract of land, occasioned by unusual freshets or other extraordinary causes. It does not include the water flowing in the hollows or ravines in land, which is the mere surface water from rains or melting snow, and is discharged through them from a higher to a lower level, but which at other times are destitute of water. Such hollows or ravines are not in legal contemplation watercourses. (*Hoyt vs. City of Hudson* 27 Wis. 656 (1871), Wisconsin Supreme Court)

(63) MISCELLANEOUS. Standards or Specifications Abbreviations.

A.G.A. American Gas Association, Inc.
420 Lexington Ave.
New York, New York 10017

A.N.S.I. American National Standards Institute, Inc.
1430 Broadway
New York, New York 10018

A.S.M.E. American Society of Mechanical Engineers
345 East 47th Street
New York, New York 10017

A.S.S.E. American Society of Sanitary Engineering
P.O. Box 9712
Bay Village, Ohio 44140

A.S.T.M. American Society for Testing and Materials
100 Barr Harbor Drive
West Conshohocken, Pennsylvania 19428-2959

A.W.W.A. American Water Works Association
Data Processing Department
6666 West Quincy Avenue
Denver, Colorado 80235

C.S. Commercial Standards, Supt. of Documents
Governmental Printing Office
Washington, D.C. 20401

F.S. Federal Specifications
General Services Administration
Regional Office 3
Washington, D.C. 20407

M.S.S. Manufacturers Standardization Society of
the Valve and Fittings Industry
127 Park Street, N.E.
Vienna, Virginia 22180

N.S.F. National Sanitation Foundation International
P.O. Box 130140
Ann Arbor, Michigan 48113-0140

U.L. Underwriters' Laboratories, Inc.
333 Pfingsten Road
Northbrook, Illinois 60062

W.C.F. Water Conditioning Foundation
1201 Waukegan Road
Glenview, Illinois 60025

Note: For definitions of master plumber, journeyman, restricted plumbers, apprentices, registered learners and certified soil tester, refer to ch. 145, Stats.

History: Cr. Register, December, 1980, No. 300, eff. 1-1-81; renum. from H 63.02, Register, June, 1983, No. 330, eff. 7-1-83; cr. (29m), (54m), (56m) and (56n), Register, June, 1991, No. 426, eff. 7-1-91; r. and recr. (18), cr. (54q), Register, April, 1992, No. 436, eff. 5-1-92; r. (2) and (10), Register, February, 1994, No. 458, eff. 3-1-94; corrections in (19) made under s. 13.93 (2m) (b) 7., Stats., Register, February, 1994, No. 458.

Comm 83.03 Approvals and limitations. (1) ALLOWABLE USE. Septic tank and effluent absorption systems or other treatment tank and effluent disposal systems as may be approved by the department may be constructed when no public sewerage system is available to the property to be served. Unless specifically approved by the department, the private sewage system of each building shall be entirely separate from and independent of that of any other building. A private sewage system may be owned by the property owner or by a special purpose district. The use of a common system or a system on a different parcel than the structure will be subject to the same plan review procedures as for systems serving public buildings.

(2) PUBLIC SEWER CONNECTION. When public sewers approved by the department of natural resources become available to the premises served, the use of the private sewage system shall be discontinued within that period of time required by order, but not to exceed one year. The building sewer shall be disconnected from the private sewage system and be connected to the public sewer. All abandoned treatment tanks and seepage pits shall have the contents pumped and disposed of in accordance with ch. NR 113, Wis. Adm. Code. The top or entire tank shall be removed and the remaining portion of the tank or excavation shall be immediately filled with suitable soil material.

(3) FAILING SYSTEM. When a failing or malfunctioning private sewage system is encountered, the sewage disposal system shall be corrected or its use discontinued within that period of time required by county or departmental order, with a maximum time limit of one year.

History: Cr. Register, December, 1980, No. 300, eff. 1-1-81; renum. from H 63.03, Register, June, 1983, No. 330, eff. 7-1-83.

Comm 83.035 Petitions for variance. The department shall consider a petition for a variance to a rule of this chapter in accordance with ch. ILHR 3. The department shall grant a variance provided an equivalency to the intent of the specific rule can be established.

Note: The department cannot grant a petition for an issue which is also specifically covered by the statutes; for example, a petition to waive the requirement to obtain a sanitary permit to install a new private sewage system.

Note: As a result of a court action, s. Comm 83.035 was prevented from taking effect on June 1, 1996. Prior to June 1, 1996, s. Comm 83.035 did not exist.

History: Cr. Register, May, 1996, No. 485, eff. 6-1-96.

Comm 83.04 Specific limitations. (1) DOMESTIC WASTE. All water carried wastes derived from ordinary living uses shall enter the septic or treatment tank unless otherwise specifically exempted by the department or this chapter.

(2) CESSPOOLS. Cesspools are prohibited.

(3) INDUSTRIAL WASTES. The department of natural resources shall be contacted in regard to the treatment and disposal of all industrial wastes including those combined with domestic waste.

(4) CLEAR WATER. The discharge of surface, rain and other clear water into a private sewage system is prohibited.

(5) WATER SOFTENER AND IRON FILTER BACKWASH. Water softener or iron filter discharge may be directed to the private sewage system, or to the ground surface if a nuisance is not created.

(6) FLOODPLAIN. (a) General. A soil absorption system shall not be installed in a floodway. Soil absorption systems in the flood fringe shall not be installed unless written approval is received

from the department. The department shall receive written approval from the local government and the department of natural resources for construction in, and filling of, the floodplain area prior to reviewing and approving plans.

(b) New developments. 1. 'Floodway.' New private sewage systems shall not be installed in a floodway.

2. 'Flood fringe.' In the flood fringe the installation of individual private sewage systems will be reviewed on a case-by-case basis. It is preferable that with new systems that are allowed in "fringe" areas they be installed on land contiguous to land outside the flood plain limit. However, developments in isolated areas within the flood fringe may also be approved. Land areas shall be filled and thus removed from the flood plain designation. The amount of area to be filled is site dependent and will be evaluated on a site-by-site basis. Individual sites shall be checked by the county and may be checked by department staff to insure that soil conditions and other factors are in full accord with ch. NR 116, Wis. Adm. Code. The requirements of this chapter must be met before any placement of fill is authorized to overcome specific flooding conditions. The filled area for the building and the filled area for the private sewage system shall be connected. The extent and design of the fill for the sewage disposal system shall be in accord with the current rules of the department for systems in fill, [See s. Comm 83.10 (6).] The department of natural resources will determine whether an island within a river is located in a flood plain and if it is subject to flood plain regulations.

(c) Existing developments. 1. 'Floodway.' The following types of replacement systems may be allowed on a case-by-case basis to abate a health hazard in floodway areas:

a. Holding tanks flood proofed in accordance with s. Comm 83.18 (9); or

b. The installation of a replacement soil absorption system outside the flood plain limit connected to the development by a force main or to an approved acceptable site outside the floodway but in the flood fringe area. Septic tanks in the floodway shall be flood-proofed. The site must meet the requirements set forth in this chapter.

2. 'Flood fringe'. Malfunctioning soil absorption systems may generally be replaced provided favorable soil conditions and other site factors exist.

a. County approval and acceptance shall be documented on plumbing form SBD-6698 prior to state approval.

b. If filling is necessary and upon receipt of county approval, the specific design criteria and fill conditions will be stipulated for each installation in accord with this chapter.

Note: Soil absorption systems are preferable to holding tanks.

3. 'Processing of form SBD-6698.' Form SBD-6698 serves as the basis for department approval of sewage disposal systems in flood plain areas. A copy of this form signed by the local authority will be submitted to the department of natural resources by the department. The county authority's signature is mandatory. Approval of a new or replacement system by the department of natural resources or the department will not be granted if the form is unsigned. The department of natural resources' approval indicated by signing form SBD-6698 relates only to the accuracy of the flood plain data.

(d) Special flood plain developments. In certain flood plain areas where the installation of sewage disposal systems may be necessary but because of unique site conditions cannot comply with ch. NR 116, Wis. Adm. Code, or this chapter, the department of natural resources may authorize or approve special flood plain developments provided they are in accord with the purpose and intent of ch. NR 116, Wis. Adm. Code, and county flood plain ordinances. Special developments may include but not be limited

to such projects as campgrounds in flood plain areas, or the expansion of certain nonconforming uses.

History: Cr. Register, December, 1980, No. 300, eff. 1-1-81; renum. from H 63.04, Register, June, 1983, No. 330, eff. 7-1-83; am. (c) 1. a., Register, April, 1992, No. 436, eff. 5-1-92.

Comm 83.05 Local filing requirements. (1) SOIL TEST REPORTS. The county shall establish a filing system for soil test reports. The county shall review soil test reports for proposed private sewage disposal systems and verify the data reported if necessary. If the soil test report is considered to be adequate, the county shall file the report.

(2) COUNTY PLAN EXAMINATION FOR ONE AND 2 FAMILY RESIDENCES. (a) General. Complete plans and specifications shall be submitted to the county with the application for sanitary permit. Plans shall be submitted on paper not less than 8-1/2 by 11 inches in size. The county may set the number of plan copies required to adequately review the application for the sanitary permit and for the inspection of the private sewage system installation.

(b) Plans and specifications. All plans shall include the following:

1. 'Plot plan.' Detailed plot plan dimensioned or drawn to scale showing the lot size; the location of all septic tanks; holding tanks or other treatment tanks; building sewers—sanitary and storm; wells; water mains or water service; streams and lakes; dosing or pumping chambers; distribution boxes; effluent systems; dual disposal systems; replacement system areas; and the location of the building served. Adjoining properties shall be checked to insure that the site location distances in s. Comm 83.10 (1) are complied with. All separating distances and dimensions shall be shown on the detailed plot plan.

2. 'Reference points.' A vertical elevation reference point and a horizontal reference point.

3. 'Soil data.' Soil boring and percolation test data related to the undisturbed and finished grade elevations, vertical elevation reference point and horizontal reference point. Surface elevations shall be given for all soil borings.

4. 'Occupancy.' The maximum number of bedrooms in the residence shall be indicated.

5. 'Other specifications.' Complete specifications for pumps and controls including dose volume, elevation differences (vertical lift), pipe friction loss, pump performance curve, pump model and pump manufacturer.

(3) FEES. The county may require plan examination fees or include these fees in the cost of the sanitary permit in accord with s. 145.19 (2), Stats.

(4) REVISED PLANS. Every installer of a private sewage system who modifies or changes the design of a system must submit to the county authority a revised plan. All changes or modifications must be approved by the county authority prior to installation.

(5) ACCEPTANCE. No private sewage system shall be used until the proper sanitary permit, inspection and a revised plan, if required, has been accepted and filed by the county authority.

(6) PLAN FILING. The county shall establish a filing system which provides a system of retrieval of sanitary permits and plans and may set by ordinance a filing fee. The county may require that additional information be included on the plan to aid in filing, indexing or retrieving permits and plans.

History: Cr. Register, December, 1980, No. 300, eff. 1-1-81; renum. from H 63.05, Register, June, 1983, No. 330, eff. 7-1-83.

Comm 83.055 Issuance of building permits. Pursuant to s. 66.036, Stats., building permits issued by a county, city, village or town for construction of any structure not served by a public sewer and requiring connection to a private sewage system shall be issued in accordance with the procedures of this section.

(1) NEW CONSTRUCTION. A county, city, village or town may not issue a building permit for construction of a new structure which requires the installation of a private sewage system unless

a sanitary permit for the installation of the private sewage system has been obtained by the owner.

Note: Section Comm 83.06 outlines the procedures for the issuance of sanitary permits. Section 145.19, Stats., mandates that no private sewage system may be installed unless the owner of the property holds a valid sanitary permit.

(2) RECONNECTIONS. (a) A county, city, village or town may not issue a building permit for the following conditions unless the owner provides the information specified in par. (b):

1. Construction of a structure to be connected to an existing private sewage system;

2. Disconnection of a structure from an existing private sewage system and connection of another structure to the system; or

3. Reconstruction of a structure that is connected to a private sewage system and that has become uninhabitable due to damage resulting from fire, wind or other manmade or natural disasters.

(b) Documentation shall be provided to verify:

1. That the existing private sewage system is not a failing system and has sufficient size and soil conditions to accommodate the wastewater load as specified in sub. (3); and

2. That the structure meets the set back requirements as specified in sub. (4).

(c) Determinations of approved documentation shall be in the form of a sanitary permit or in writing.

(3) CONSTRUCTION INVOLVING AN INCREASE OF WASTEWATER LOAD. (a) General. A county, city, village or town may not issue a building permit for construction of any structure connected to a private sewage system which will increase the wastewater load to an existing private sewage system or interfere with a functioning system as specified in this subsection, unless the owner of the proposed structure:

1. Possesses a sanitary permit to either modify the existing private sewage system or construct a new private sewage system to accommodate the increased wastewater load; or

2. Provides written documentation from the department or county verifying that the existing private sewage system has sufficient size and soil conditions to accommodate the increased wastewater load.

(b) Determination of increased wastewater load. For the purpose of this section:

1. Increased wastewater load in public buildings and places of employment results from any change in use of the structure from the original use that results in an increased volume of wastewater above that for which the system was originally designed.

2. Increased wastewater load in dwellings results from an increase in the number of bedrooms or from construction of any addition or remodeling which exceeds 25% of the total gross area of the existing dwelling unit. Increased wastewater load in dwellings does not result from construction of decks, patios, garages, porches, reroofing, painting, wiring, residing, window replacements or replacement of equipment or appliances.

3. Counties may establish additional criteria for determining increased wastewater load by ordinance.

(c) Documentation. Documentation to verify whether the size of the existing private sewage system can accommodate the increased wastewater load and to verify whether the system is installed in suitable soils shall include all of the following:

1. Information on the soil conditions of the soil absorption system. The information may consist of a valid existing soil report or new soil evaluation report for the system, prepared by a certified soil tester showing conformance with the minimum 3-foot vertical separation above bedrock and groundwater specified in s. Comm 83.10 (2);

2. Information provided by a licensed master plumber or master plumber-restricted sewer, a certified soil tester, or plumbing inspector II for:

a. Sizing of the system relative to the existing usage, replacement area, and the proposed construction usage and the type of system; or

b. A copy of an affidavit signed by the owner and recorded with the register of deeds indicating that the existing private sewage system capacity serving a one- or 2-family dwelling is undersized and indicating whether a replacement area is available.

3. A plan prepared by a licensed master plumber or master plumber-restricted sewer, certified soil tester or plumbing inspector II setting forth the dimensions of the existing soil absorption area, tank location and related setbacks;

4. Information provided by a licensed master plumber or master plumber-restricted sewer, septic hauler or plumbing inspector II relative to the condition, capacities, baffles, and manhole covers for the existing treatment tanks, and the capacity of any additional treatment tanks required to accommodate the increased wastewater load; and

5. Information provided by a certified soil tester, a licensed master plumber, master plumber-restricted sewer, or plumbing inspector II showing that the system is not causing backup of sewage into the structure served, or discharge of sewage to the surface of the ground or to a drain tile, or discharge of sewage to any surface waters of the state.

(d) *On-site inspection.* If it cannot be determined from the information provided that an existing private sewage system can accommodate the increased wastewater load, the department or county may require additional information to be submitted to make the determination or the department or county shall inspect the system for:

1. The failure to accept sewage discharges and the backup of sewage into the structure served by the private sewage system;

2. The discharge of sewage to the surface waters of the ground or to a drain tile;

3. The discharge of sewage to any surface waters of the state; and

4. Conformance with the minimum 3-foot vertical separation above bedrock and groundwater specified in s. Comm 83.10 (2).

(e) *Determinations by department or county.* 1. Determination of whether an existing private sewage system is of an adequate capacity to accommodate additional wastewater loads involving one- and 2-family dwellings shall be made by the county. A county may make determinations of whether an existing private sewage system is of an adequate capacity to accommodate additional wastewater loads generated by construction other than one- and 2-family dwellings involving less than 3,000 gallons per day of wastewater load.

2. Determination of whether an existing private sewage system is of an adequate capacity to accommodate additional wastewater loads generated by construction involving structures other than one- and 2-family dwellings and 3,000 gallons or more per day of wastewater load shall be made by the department.

(f) *Determination on soil conditions.* 1. If the existing private sewage system is a failing system, the system shall be ordered replaced.

2. If the existing private sewage system is installed in mottled soils, the owner may request a variance to use the existing system and perform groundwater monitoring to verify seasonal saturation conditions under s. Comm 83.09 (7).

3. If the construction affects the only soil replacement area, written notice shall be provided to the owner indicating future wastewater options the owner may have available.

(g) *Determination on tanks.* 1. If the tanks are leaking, the tanks shall be ordered replaced.

2. If the baffles in the tank are deteriorated or missing, the baffles shall be ordered replaced.

3. If the exposed tank cover has no cover or is not locked or labeled, the cover shall be ordered replaced, locked and labeled.

4. If the tank capacity services a one- and 2-family dwelling and is:

a. Less than 500 gallons, the tank shall be ordered replaced or additional tank capacity shall be ordered added;

b. At least 750 gallons, the existing tank may be used provided no more than one additional bedroom is added;

c. At least 750 gallons and 2 or more bedrooms are being added, additional tank capacity shall be ordered added.

5. If the tank serves any structure other than a one- and 2-family dwelling, additional tank capacity shall be ordered.

(h) *Determinations on setbacks.* All determinations on setbacks involving an increase in wastewater loads shall conform to sub. (4) (c) and (d).

(4) **CONSTRUCTION NOT INCREASING WASTEWATER LOADS.** (a) A county, city, village or town may issue a building permit for construction of:

1. Any structure on a property containing a private sewage system if the construction does not increase the wastewater load as specified in sub. (3); or

2. An accessory structure not connected to a private sewage system.

3. The completed construction shall conform to the setback limitations specified in s. Comm 83.10 (1), 83.15 (4) (a) or 83.18 (7) (a).

(b) Documentation shall be provided by the owner, licensed master plumber or master plumber-restricted sewer, certified soil tester or plumbing inspector II showing the location and setback distances for the proposed construction of any structure relative to the components of the private sewage system.

(c) Determinations of whether the location and setback distances of a proposed construction will interfere with an existing private sewage system shall be made by the department or the county. On-site inspections may be made to verify the location and setback distances. Determinations shall be made in writing and provided to the agency responsible for issuing the building permit.

(d) No sanitary permit shall be required for construction that conforms to the setback requirements and that does not involve an increase in wastewater load.

(e) No building permit may be issued where setback requirements cannot be met unless:

1. A petition for variance is obtained from the department; or

2. The owner agrees in writing to correct any deficiencies discovered during construction for a system that cannot be located.

(f) Any variance submitted under this section shall be reviewed by the county prior to submitting to the department. The county may submit any information relative to the variance.

(5) **FEEES.** The department or county may assess and collect a fee to defray the cost of administering this section.

History: Emerg. cr. 12-1-88; cr. Register, August, 1989, No. 404, eff. 9-1-89.

Comm 83.06 County administration. (1) **PRIVATE SEWAGE SYSTEM ORDINANCE.** (a) *Adoption of ordinance.* Every county shall adopt an ordinance governing private sewage systems which conforms with this chapter. The ordinance shall apply to the entire area of the county. (Ref. s. 59.065 (1), Stats.)

(b) *Enforcement.* The county shall administer the private sewage system ordinance in accordance with s. 145.20, Stats., and this chapter.

(2) **SANITARY PERMITS.** (a) *General.* The county shall establish administrative procedures for the approval, disapproval or issuance of state sanitary permits in accord with s. 145.135, and s. 145.19, Stats., and this chapter.

(b) *Application.* The application for a sanitary permit shall be made on forms furnished by the department. Before a private sewage system is installed a licensed master plumber or master restricted plumber (sewer) shall sign the application for permit

and assume responsibility for installation of the system. (Ref. ss. 145.06 and 145.135, Stats.)

(c) *Permit transfer.* When there is a change of ownership, building use or master plumber, a permit transfer form furnished by the department shall be submitted to the county for approval prior to the installation of a private sewage system. Failure to submit transfer forms to the county shall invalidate the sanitary permit in accord with s. 145.135 (1), Stats. The county may charge a fee for the transfer of a sanitary permit.

(d) *Posting.* The sanitary permit shall be issued by the county on forms furnished by the department. The sanitary permit shall be displayed conspicuously so as to be visible from the road fronting the lot during construction.

(3) COUNTY ORGANIZATION AND PERSONNEL. (a) *Assignment of duties.* The county board may assign the duties of administering the private sewage system program to any county office, department, committee, board, commission, position or employee.

(b) *Certified soil tester.* The county shall obtain the services of a certified soil tester, either as a county employe or under contract, to review and verify certified soil tester reports.

(4) COUNTY RESPONSIBILITIES. (a) *Review of soil test reports.* The county shall review certified soil tester reports for proposed private sewage systems and verify the report at the proposed site, if necessary.

(b) *Review of applications for sanitary permits.* The county shall approve or disapprove applications for sanitary permits and assist applicants in preparing an approvable application.

(c) *Written notice.* The county shall issue written notice to each applicant whose sanitary permit application is disapproved. Each notice shall state the specific reasons for disapproval and amendments to the application, if any, which render the application approvable. Each notice shall also give notice of the applicant's right to appeal and the procedures for conducting an appeal under ch. 68, Stats.

(d) *Inspections.* The county shall inspect all private sewage systems after construction but before backfilling no later than the end of the next workday, excluding Saturdays, Sundays and holidays, after receiving notice from the plumber in charge. Inspections shall be reported on forms furnished by the department.

(e) *Reports and surveys.* The county shall file reports and conduct surveys and inspections as required by the county or the department.

(f) *Investigate violations.* The county shall investigate violations of the private sewage system ordinance and s. 146.13, Stats., issue orders to abate the violations and submit orders to the district attorney, corporation counsel or attorney general for enforcement.

(g) *Other duties.* The county shall perform other duties regarding private sewage systems as considered appropriate by the county or as required by the rules of the department.

(5) DEPARTMENT RESPONSIBILITIES. (a) *Department approval.* The department may specify categories of private sewage systems for which approval by the department is required prior to issuance of sanitary permits by the county.

(b) *Department audit.* The department shall review the private sewage system program in each county to ascertain compliance with s. 145.20 (2), Stats., and with rules promulgated by the department. This review shall include a random audit of sanitary permits, including verification by on-site inspection.

(c) *Compliance.* If a county board does not adopt a private sewage system ordinance meeting the requirements of s. 59.065, Stats., or if the county does not appoint personnel meeting the requirements of s. 145.20 (1), Stats., or if the county does not comply with the requirements of s. 145.20 (2), Stats., the department may conduct hearings in the county seat upon 30 days notice to the county clerk. As soon as practicable after the public hearing, the department shall issue a written decision regarding compliance with s. 59.065 or 145.20 (1) and (2), Stats. If the department deter-

mines that there is a violation of these provisions, the county may not issue a sanitary permit for the installation of a private sewage system until the violation is corrected.

(d) *Training.* The department shall conduct training and informational programs for county officials and employes and persons licensed under this chapter and s. 146.20, Stats., to improve the delivery of service under the county private sewage system program. The department shall obtain the assistance of the Wisconsin county boards association in planning and conducting the training and informational programs.

Note: Subsections (3) to (5) are taken from ch. 145, Stats.

History: Cr. Register, December, 1980, No. 300, eff. 1-1-81; renum. from H 63.06, Register, June, 1983, No. 330, eff. 7-1-83.

Comm 83.07 Plan review—department. (1) APPROVALS. (a) *One- and 2-family residences.* Unless required elsewhere in this chapter, the submission of plans and specifications and departmental approval of initial, modified, additional or replacement construction of private sewage systems serving one- and 2-family residences is not required. All applicable plans, permits and approvals required by county government shall be obtained prior to the commencing of construction. The county government shall require plans and specifications prior to issuing permits or approval. [See s. Comm 83.05 (2).]

(b) *Public buildings—department approval.* Complete plans and specifications shall be submitted in accord with this section. Written approval shall be received before sanitary permits are issued for the initial installation of a private sewage system or for the addition to, modification or replacement of the system, if the system serves or will serve any public buildings. The owner shall submit a copy of the approved plans to the county authority. Included as public buildings but not limited by enumeration are: Theaters and assembly halls; schools and other places of instruction; apartment buildings, hotels and places of detention; factories, office and mercantile buildings; mobile home parks, campgrounds and camping resorts and parks.

(c) *Public buildings—local approval.* Approval by the county shall not eliminate the need for approval by the department for the installation of private sewage systems serving public buildings. Departmental approval shall not eliminate the need for obtaining all required county permits and approvals.

(d) *Plan review processing time.* The department shall review and make a determination on an application for plan review within 15 business days of receiving the required information and fees.

(2) SUBMISSION OF PLANS AND SPECIFICATIONS—PUBLIC BUILDINGS. All plans and specifications shall be submitted in duplicate and shall include the following:

(a) *Plot plan.* Detailed plot plan dimensioned or drawn to scale showing the lot size; the location of all septic tanks, holding tanks or other treatment tanks, building sewers—sanitary and storm, wells, water mains or water service, streams and lakes, dosing or pumping chambers, distribution boxes, effluent disposal systems, dual disposal systems, and disposal replacement areas; and the location of the public building served by such systems. Adjoining properties shall be checked to insure that the site location distances in s. Comm 83.10 (1) are complied with. All distances and dimensions shall be shown on the detailed plot plan;

(b) *Legal description.* Legal description of the property on which the system is to be installed;

(c) *Reference points.* A vertical elevation reference point and a horizontal reference point;

(d) *Soil data.* Soil boring and percolation test data related to the undisturbed and finished grade elevations and vertical elevation reference point and horizontal reference point;

(e) *Contours—original grade.* Ground slope with 2-foot contours for the original, undisturbed grade elevation of the entire area of the soil absorption system and the area on all sides for a distance of 25 feet;

(f) *Contours—altered sites.* Ground slope with 2-foot contours for the grade elevation of the entire area of the soil absorption system and the area on all sides for a distance of 25 feet after alteration of the landscape;

(g) *Use and occupancy.* Complete data relative to the maximum expected use and occupancy of the building to be served considering all anticipated future growth plans;

(h) *Other specifications.* Complete specifications for pumps and controls including dose volume, elevation differences (vertical lift), friction loss, pump performance curve, pump model and pump manufacturer.

(3) **PLAN EXAMINATION FEE.** All plans and specifications submitted to the department for review shall be accompanied with fees as established in s. Comm 83.08.

(4) **PLAN REVISIONS.** Revisions to approved plans and specifications shall be approved by the department.

(5) **PLAN AVAILABILITY.** One set of plans bearing the department's stamp of approval shall be maintained at the project site during construction of any private sewage system serving a public building.

History: Cr. Register, December, 1980, No. 300, eff. 1-1-81; renum. from H 63.07, Register, June, 1983, No. 330, eff. 7-1-83; cr. (1) (d), Register, February, 1985, No. 350, eff. 3-1-85.

Comm 83.08 Examination of plans and specifications. (1) **PLAN EXAMINATION REQUIRED.** (a) Except as provided in sub. (2) (d), plans and specifications for the following types of private sewage systems shall be submitted to the department for review:

1. Pressure distribution system;
2. Mound system;
3. Holding tank;
4. Experimental system; and
5. A conventional soil absorption system to serve a public building.

(b) When plans and specifications for a type of private sewage system specified in par. (a) are submitted to the department for review, written approval for the plans shall be obtained from the department prior to a sanitary permit being issued for the system or installation of the system commences.

(2) **PLAN SUBMISSION.** (a) *Stamping and signing plans.* All plans and specifications shall be sealed or stamped in accord with ch. A-E 2, Wis. Adm. Code by a registered architect, engineer or registered plumbing designer. A master plumber may design and submit for approval plumbing plans and specifications for a private sewage system which they are to install. Each sheet of plans and specifications the master plumber submits shall be signed, dated and include their Wisconsin master plumber license number. When more than one sheet is bound together into one volume, only the title sheet or index sheet need be signed and dated by the master plumber responsible for their preparation, provided the signed sheet clearly identifies all of the other sheets comprising the bound volume.

(b) *Submitting data.* All plans, preliminary or complete, shall be submitted in duplicate. Work shall not commence until written approval for the preliminary or complete plans is received from the department. The plans submitted shall be prints that are clear, legible and permanent. All pertinent data shall be a part of or shall accompany all plans submitted for review. Plans will be examined in the order of receipt.

(c) *Additions and alterations.* This section shall apply to all additions, alterations and modifications as well as to all new private sewage systems and shall apply to all cases where there is a change of the type of occupancy or use of building which requires changes to or intended use of the plumbing or private sewage system so as to comply with this chapter for that occupancy or use.

(d) *Agent municipalities.* 1. Upon request from a county, the department may delegate to a county the review of plans for one

or more of the following types of private sewage systems which are to be or are located within the jurisdiction of that county:

- a. Holding tank; and
- b. Conventional soil absorption system serving a public building.

2. A request by a county to review the types of plans specified in subd. 1. shall be made in writing. The request shall include information delineating how the systems are to be processed and reviewed and how plan review decisions are to be recorded and maintained.

3. The delegation of plan review by the department shall be contingent upon a county's request demonstrating sufficient and adequate capabilities and methods, including the involvement of one or more individuals certified to conduct soil morphological evaluations, to provide assistance in the plan review process.

Note: The requirements of this subdivision do not require the employment of 2 individuals in order to perform plan review. The individual who is to perform the plan review may also be a soil tester certified to conduct soil morphological evaluations.

4. a. The delegation or the denial of delegation relative to a request concerning plan review under this paragraph shall be made in writing by the department.

b. The delegation for plan review shall be such that the submission and review of plans for the types of plans specified in subd. 1. may, at the discretion of the submitter, be made to the department or the delegated county.

5. The department shall include as part of the audits conducted in accordance with s. Comm 83.06 (5) an evaluation of the plan review functions which may have been delegated to a county under this paragraph.

6. A county which wishes to discontinue the delegated plan review function under this paragraph shall notify the department in writing at least 30 days prior to the discontinuance.

(3) **PLAN EXAMINATION FEES.** Fees shall be charged in accordance with s. Comm 2.65.

(4) **REVISIONS.** After written approval is granted, plans and specifications of plumbing systems shall not be changed without written consent of the department and the architect, engineer, designer or master plumber responsible for the design.

(5) **LIMITATIONS.** In granting approval of plans, specifications, products, devices or materials, the department is not liable for any defects in construction, nor for any damages that may result from the specific installation.

(6) **PLAN AVAILABILITY.** The architect, professional engineer, registered designer, owner or plumbing contractor shall keep at the construction site one set of plans bearing the stamp of approval of the department.

History: Cr. Register, December, 1980, No. 300, eff. 1-1-81; r. and recr. (3), Register, June, 1982, No. 318, eff. 7-1-82; renum. from H 63.08, Register, June, 1983, No. 330, eff. 7-1-83; r. and recr. (1) and (2) (d), Register, February, 1994, No. 458, eff. 3-1-94; correction in (3) made under s. 13.93 (2m) (b) 7., Stats., Register, February, 1994, No. 458.

Comm 83.09 Site evaluation. (1) **GENERAL.** Site evaluation shall be conducted by a soil tester certified by the department in accord with ch. Comm 5. The evaluation shall include soil conditions, properties and permeability, depth to zones of soil saturation, depth to bedrock, slope, landscape position, all setback requirements and the potential for flooding. Soil test data shall relate to the undisturbed elevations and a vertical elevation reference point or benchmark must be established. Evaluation data shall be reported on forms provided by the department and signed by the certified soil tester. Reports shall be filed for all sites investigated within 30 days of the completion of testing.

(2) **REPLACEMENT SYSTEM AREA.** (a) *General.* On each parcel of land being initially developed, sufficient area of suitable soils, based on the soil tests and system location and site requirements contained in this chapter, for one replacement system shall be established. Where bore hole test data in the replacement system area are equivalent to that in the proposed system area, the percolation test may be eliminated.

(b) *Non-conforming site conditions.* The department shall be contacted for approval of replacement systems for all public buildings and all buildings where site conditions do not permit systems in accord with this chapter. Alternates for the disposal of effluents emanating from existing structures may be accomplished by means other than those outlined in this chapter provided written local approval is obtained and submitted along with detailed plans and specifications to the department for review and consideration. Written approval shall be received from the department prior to the county issuing permits or work commences on these systems.

(c) *Undisturbed site.* The replacement system area shall not be disturbed to the extent that it is no longer a suitable system area. The replacement system area shall not be used for the following:

1. Construction of buildings;
2. Parking lots or parking areas;
3. Below ground swimming pools;
4. Any other use that may adversely affect the replacement area.

(3) **SLOPE.** (a) *General.* A conventional soil absorption system shall not be located on a land slope of greater than 20%. A conventional soil absorption system shall be located at least 20 feet from the crown of a land slope that is greater than 20% except where the top of the aggregate of a system is at or below the bottom of an adjacent roadside ditch.

(b) *Specific system designs.* Where a more restrictive land slope is to be observed for a soil absorption system other than a conventional system, the more restrictive land slope specified in the design sections of this chapter shall apply.

(4) **SOIL BORINGS AND PROFILE DESCRIPTIONS.** (a) *General.* Soil borings shall be conducted on all sites regardless of the type of private sewage system planned to serve the parcel. Borings shall extend at least 3 feet below the bottom of the proposed system. Borings shall be of sufficient size and extent to determine the soil characteristics important to on-site liquid waste disposal. Borehole data shall be used to determine the suitability of the soils at the site with respect to zones of seasonal or permanent soil saturation, and the depth to bedrock. Borings shall be conducted prior to percolation tests to determine whether the soils are suitable to warrant percolation tests and if suitable, at what depth percolation tests shall be conducted. The use of power augers for soil borings is prohibited.

Note: Backhoe borings are preferable to borings augered or dug by hand.

(b) *Number.* There shall be a minimum of 3 suitable borings per soil absorption site. More soil borings may be necessary for accurate evaluation of a site.

1. 'Depth of borings.' Borings shall be constructed to a depth of at least 3 feet below the proposed depth of the system.

2. 'Exceptions.' On new parcels, the requirement of 6 borings (3 for initial area and 3 for replacement area) may be reduced to 5 if the initial and replacement system areas are contiguous and one boring is made on each outer corner of the contiguous area and the fifth boring is made between the system areas. See diagram.

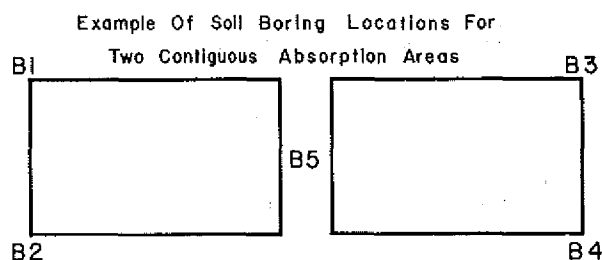

3. 'Reports.' Regardless of the number of borings evaluated and conditions observed in borings, all soil information derived from borings shall be reported.

4. 'Location.' Each borehole location shall be accurately located and referenced to the vertical elevation and horizontal reference point. Reports of boring locations shall either be drawn to scale, or have the horizontal dimensions clearly indicated between the borings and the horizontal reference point.

(c) *Soil description.* Soil profile descriptions shall be written for all borings. The thickness in inches of the different soil horizons observed shall be indicated. Horizons shall be differentiated on the basis of color, texture, soil mottles or bedrock. Depths shall be measured from the ground surface.

(d) *Soil mottles.* Zones of seasonal or periodic soil saturation shall be estimated at the highest level of soil mottles. The county or department may require a detailed description of the soil mottling on a marginal site. The abundance, size, contrast and color of the soil mottles should be described in the following manner.

1. 'Abundance.' Abundance shall be described as few if the mottled color occupies less than 2% of the exposed surface; common if the mottled color occupies from 2 to 20% of the exposed surface; or many if the mottled color occupies more than 20% of the exposed surface.

2. 'Size.' Size refers to length of the mottle measured along the longest dimension and shall be described as fine if the mottle is less than 5 millimeters; medium if the mottle is from 5 millimeters to 15 millimeters; or coarse if the mottle is greater than 15 millimeters.

3. 'Contrast.' Contrast refers to the difference in color between the soil mottle and the background color of the soil and is described as faint if the mottle is evident but recognizable with close examination; distinct if the mottle is readily seen but not striking; or prominent if the mottle is obvious and one of the outstanding features of the horizon.

4. 'Color.' The color(s) of the mottle(s) shall be given.

(e) *Observed groundwater.* The depth to groundwater if present shall be reported. Observed groundwater shall be reported at the level groundwater reaches in the soil borehole, or at the highest level of sidewall seepage into the boring. Measurements shall be made from ground level. Soil above the water level in the boring shall be checked for the presence of soil mottles.

(f) *Color patterns not indicative of soil saturation.* 1. 'One foot exception.' Soil profiles that have an abrupt textural change with finer textured soils overlying more than 4 feet of unmottled, loamy sand or coarser soils can have a mottled zone in the finer textured material. If the mottled zone is less than 12 inches thick and is immediately above the textural change, then a soil absorption system may be installed in the loamy sand or coarser material below the mottled layer. If any soil mottles occur within the sandy material, then the site shall be unsuitable. The county or department may determine certain coarse sandy loam soils to be included as a coarse material.

2. 'Other soil color patterns.' Soil mottles can occur that are not due to zones of seasonal or periodic soil saturation. Examples of such soil conditions not limited by enumeration are:

- a. Soil mottles formed from residual sandstone deposits.
- b. Soil mottles formed from uneven weathering of glacially deposited material, or glacially deposited material that may be naturally gray in color. This may include concretionary material in various stages of decomposition.
- c. Deposits of lime in a profile derived from highly calcareous parent material.
- d. Light colored silt coats deposited on soil ped faces.
- e. Soil mottles that are usually vertically oriented along old or decayed root channels with a dark organic stain usually present in the center of the mottled area.

3. 'Reporting exceptions.' A certified soil tester shall report any mottled soil condition. If soil mottles are observed that may not be due to soil saturation, the soil tester still shall report such

condition and may request a determination from the department or the county authority on the acceptability of the site.

(g) *Bedrock*. The depth to bedrock except sandstone shall be established at the depth in a soil boring where greater than 50% of the weathered in-place material is consolidated. Sandstone bedrock shall be established at the depth where an increase in resistance to penetration of a knife blade occurs.

(4m) **SOIL EVALUATION FOR ABSORPTION SYSTEMS**. System sizing and siting for all soil absorption systems shall be based on soil morphological conditions specified in sub. (4) and Table 0, or percolation tests specified in sub. (5). Percolation tests shall not be performed nor shall percolation test results be accepted after July 1, 1994 except in accordance with sub. (4n).

TABLE 0
MAXIMUM WASTEWATER INFILTRATION RATES FOR SOIL ABSORPTION SYSTEMS

If the answer to the condition is yes, the infiltrative, exposed natural soil surface for the system shall be sized using the identified soil loading factor in gallons per square foot per day.^{1,2,3}

Soil Condition	Beds	Trenches
A. Is the soil texture of the entire profile 3 feet below the infiltrative surface extremely gravelly sand, gravelly coarse sand or coarser?	0.4 ⁴	0.4 ⁴
B. Is the soil structure of the horizon moderate or strong platy?	NP ^{5,6}	0.2 ⁷
C. Is the soil texture of the horizon sandy clay loam, clay loam, silty clay loam, silt loam or finer, and the soil structure weak platy?	NP ^{5,6}	0.3 ⁷
D. Is the moist soil consistence of the horizon stronger than firm or any cemented class?	NP ^{5,6}	NP ^{5,6}
E. Is the soil texture of the horizon sandy clay, clay or silty clay of high clay content, and the soil structure massive or weak?	NP ^{5,6}	NP ^{5,6}
F. Is the soil texture of the horizon sandy clay loam, clay loam, silty clay loam, silt or silt loam and the soil structure massive?	NP ^{5,6}	0.2 ⁷
G. Is the soil texture of the horizon sandy clay, clay or silty clay of low clay content, and the soil structure moderate or strong?	0.2	0.3
H. Is the soil texture of the horizon sandy clay loam, clay loam, silty clay loam or silt loam and the soil structure weak?	0.2	0.3
I. Is the soil texture of the horizon sandy clay loam, clay loam or silty clay loam, and the soil structure moderate or strong?	0.4	0.5
J. Is the soil texture of the horizon loam or sandy loam and the soil structure massive?	0.3	0.4
K. Is the soil texture of the horizon loam or sandy loam and the soil structure weak?	0.4	0.5
L. Is the soil texture of the horizon sandy loam, loam or silt loam, and the soil structure moderate or strong?	0.5	0.6
M. Is the soil texture of the horizon very fine sand or loamy very fine sand? Or condition N below but with massive soil structure?	0.4	0.5
N. Is the soil texture of the horizon fine sand or loamy fine sand?	0.5	0.6
O. Is the soil texture of the horizon loamy sand, sand or coarse sand?	0.7	0.8

Footnotes to Table 0

1. The infiltration rates may be adjusted due to crossing horizons at the proposed infiltrative surface. Where such conditions occur, a weighted average may be used to determine the infiltration rate.
2. The infiltration rates and soil conditions specified may be verified by the county or department, who may require modification of these rates, particularly where soil conditions exist that are not specifically referenced in this table.
3. A soil description report (SBD-8330) shall be completed for each soil profile. The reported texture, structure and consistence shall be used in calculating the loading rate of the infiltrative soil surface.
4. Pressure distribution shall be provided in accordance with s. Comm 83.14, except that doses shall be provided more than 4 times per day to increase retention time. Department written approval is required for sites where voids between gravels and cobbles are not filled with soil material of 2 millimeters or less in size. If at least a 6-foot separation below the proposed system to a limiting factor is evaluated and determined, or if a sand textured blanket at least one-foot thick is provided at the infiltrative surface, then a soil loading rate of 0.8 may be used with or without pressure distribution. Split spoon or power auger equipment may be used for evaluations at depths of more than 3 feet below the proposed system, provided such usage is noted on the soil description report.
5. NP = Not permitted. Systems may be permitted in these soils only with prior department approval. Site specific department approval will not be required where standard approvals have been issued based on a design concept or regional soil conditions.
6. Soil horizons meeting conditions D or E are not permitted within 3 feet below the infiltrative surface of either seepage beds or trenches. Soil horizons meeting conditions B, C or F are not permitted within 3 feet below the infiltrative surface of seepage beds.
7. Pressure distribution is required.

(4n) **PERCOLATION TEST RESULTS FOR SIZING ABSORPTION SYSTEMS**. The sizing of soil absorption systems shall be based upon either:

(a) Tables 1 and 4 if percolation test results are filed with the county in accordance with sub. (1), prior to July 1, 1991; or

(b) Tables 1a, 1b, and 4a if percolation test results are filed with the county in accordance with sub. (1) after July, 1991;

(c) Table 0 if soil evaluation reports as specified in sub. (4m) are filed with the county in accordance with sub. (1).

(5) PERCOLATION TESTS AND PROCEDURES. (a) *Number and location.* At least 3 percolation tests in each system area shall be conducted. The holes shall be located uniformly in the location and to the bottom depth of the proposed absorption system. More percolation tests may be necessary depending on system design.

(b) *Exemption.* Percolation tests may not be required where a detailed soil map clearly indicates loamy sand or coarser material conditions at the depth of the proposed system, and for 3 feet below and the soil condition is confirmed by soil borings. The percolation rate for design purposes shall be calculated using the slowest permeability listed in the soil survey report for the map unit. The county or department may require proof of the map findings or soil texture and resultant anticipated percolation rate. The exemption of percolation tests does not eliminate the required bore hole test data.

(c) *Percolation test hole.* The test hole shall be dug or bored. It shall have vertical sides and have a horizontal dimension of 4 to 8 inches. The bottom and sides of the hole shall be carefully scratched with a sharp pointed instrument to expose the natural soil. All loose material shall be removed from the hole and the bottom shall be covered with 2 inches of gravel or coarse sand.

(d) *Test procedure—sandy soils.* For tests in sandy soils the hole shall be carefully filled with clear water to a minimum depth of 12 inches above the bottom of the hole. The time for this amount of water to seep away shall be determined and this procedure shall be repeated. If the water from the second filling of the hole seeps away in 10 minutes or less, the test may proceed immediately as follows. Water shall be added to a point not more than 6 inches above the gravel or coarse sand. Thereupon, from a fixed reference point, water levels shall be measured at 10-minute intervals for a period of one hour. If 6 inches of water seeps away in less than 10 minutes, a shorter interval between measurements shall be used, but in no case shall the water depth exceed 6 inches. If 6 inches of water seeps away in less than 2 minutes, the test shall be stopped and a rate of less than 3 minutes per inch shall be reported. The final water level drop shall be used to calculate the percolation rate. Soils not meeting the above requirements shall be tested as in par. (e).

(e) *Test procedure—other soils.* The hole shall be carefully filled with clear water and a minimum water depth of 12 inches shall be maintained above the bottom of the hole for a 4-hour period by refilling whenever necessary or by use of an automatic siphon. Water remaining in the hole after 4 hours shall not be removed. Thereafter the soil shall be allowed to swell not less than 16 hours nor more than 30 hours. Immediately following the soil swelling period, the measurements for determining the percolation rate shall be made as follows. Any soil which has sloughed into the hole shall be removed and the water level shall be adjusted to 6 inches over the gravel or coarse sand. Thereupon, from a fixed reference point, the water level shall be measured at 30-minute intervals for a period of 4 hours unless 2 successive water level drops do not vary by more than 1/16 of an inch. At least 3 water level drops shall be observed and recorded. The hole shall be filled with clear water to a point not more than 6 inches above the gravel or coarse sand whenever it becomes nearly empty. Adjustment of the water level shall not be made during the last 3 measurement periods except to the limits of the last measured water level drop. When the first 6 inches of water seeps away in less than 30 minutes, the time interval between measurements shall be 10 minutes and the test run for one hour. The water depth shall not exceed 6 inches at any time during the measurement period. The drop that occurs during the final measurement period shall be used in calculating the percolation rate.

(f) *Mechanical test equipment.* Mechanical percolation test equipment shall be submitted to the department for approval.

(6) VERIFICATION. (a) *Borings.* Depth to soil mottles, depth to high groundwater, soil textures, depth to bedrock and land slope may be subject to verification by the county or the department. The county or the department may require backhoe pits to be provided for verification of soil boring data.

(b) *Percolation tests.* The results of percolation tests may be subject to verification by the county or the department. The county or the department may require that percolation tests be reducted under supervision.

(c) *Filling.* Where the natural soil condition has been altered by filling or other methods used to improve wet areas, the department may require observation of high groundwater levels under saturated soil conditions.

Note: Detailed soil maps are of value for determining estimated percolation rates and other soil characteristics.

(7) MONITORING GROUNDWATER LEVELS. (a) *General.* A property owner or developer may provide documentation to the department and the county that soil mottling or other soil color patterns at a particular site are not an indication of seasonally saturated soil conditions or high groundwater levels. Documentation shall be made by conforming to the criteria in either subd. 1. or 2., unless sites are monitored against broad regional water tables in accordance with par. (b) 2.

1. A written report evaluating soil mottling and soil color patterns may be submitted to the department for review and approval. The report shall be prepared by a certified soil tester who has passed the examination specified in ch. Comm 5. The written report shall include the following:

a. A review of the soils and landscape in the area of the proposed system installation;

b. Soil descriptions to a depth of 5 feet below the bottom of the proposed system, to the depth of bedrock, or to a saturated zone, whichever is shallower, using the United States department of agriculture system. The soil description shall identify each soil horizon for its texture, structure, consistence, Munsell colors, depth measured from the soil surface, macroporosity, continuity, boundary conditions, and any other factors that would influence the operation or design of the proposed soil absorption system;

c. Description of the mottling including size, abundance, contrast and Munsell color and reasons for the mottling;

d. A recommended design loading rate from Tables 0, 1 or 4; linear loading rate; depth of the proposed system, geometry, and type of suitable soil absorption system that should be used on the site for disposal of wastewater;

e. The soil types or series listed in a United States department of agriculture soil survey in the immediate area;

f. A description of the site, including a 2 foot topographic contour map of the system area and 25 feet beyond; description of the vegetation and current land use; details of any artificial drainage; location of all compacted areas including roads and drives; and drainage patterns that may affect the proposed soil absorption system; and

g. Written comments provided by the county. If the county has no comments, the county shall so state.

2. Groundwater levels may be monitored at specific sites in accordance with the procedures in pars. (b) through (f). Written notice of an intent to monitor shall be submitted to the department and the county with a completed "Soil Description Report" (SBD-8330) prior to monitoring.

3. The report shall be submitted to the department for review and approval. The department may perform an onsite inspection to review the soil conditions.

(b) *Precipitation.* 1. In areas not subject to broad regional water tables, monitoring results shall be considered when the

highest of either the precipitation received at a local station, or the average of the 3 closest local stations, equals or exceeds, for both the periods (September 1 through the last day of February, and March 1 through May 31), 8.5 inches and 7.6 inches respectively.

2. Where sites are subject to broad regional water tables, such as large areas of sandy soils, the fluctuation observed over a several year cycle shall be considered. In such cases, data obtained from the United States geological survey or other independent agency utilizing United States geological survey procedures shall be used to determine if a regional water table is at or near its normal level. Determinations shall be made using hydrograph data and submitted on forms provided by the department.

(c) *Artificial drainage.* Areas which are to be monitored shall be carefully checked for drainage tile and open ditches which could have altered natural high groundwater levels. Where such factors are involved, information on the location, design, ownership and maintenance responsibilities for such drainage shall be provided. Documentation shall be provided to show that the drainage network has an adequate outlet, and can and will be maintained. Sites affected by agricultural drain tile shall not be acceptable for system installation.

(d) *Procedures.* 1. 'Soil tester.' Monitoring shall be done by

a certified soil tester.

2. 'Notification.' The certified soil tester shall notify in writing, the county sanitary permit issuing authority or the department, of intent to monitor. It is expected the county authority or department may field check the monitoring at least once during the time of expected saturated soil conditions.

3. 'Number of wells.' At least 3 wells shall be monitored at a site for a proposed system and replacement. If in the judgement of the county authority or the department more than 3 monitoring sites are needed, the certified soil tester shall be so advised in writing.

4. 'Monitoring well design.' Monitoring wells designed as shown in the following sketch shall be constructed for monitoring. At least 2 wells shall extend to a depth of at least 6 feet below ground surface and shall be a minimum of 3 feet below the designed system depth. However, with layered mottled soil over permeable unmottled soil, at least one well shall terminate within the mottled layer. Site conditions may, in some cases, require monitoring at greater depths. It will be the responsibility of the certified soil tester to determine the depth of the monitoring wells for each specific site and if in doubt, they shall request the guidance of the county or the department.

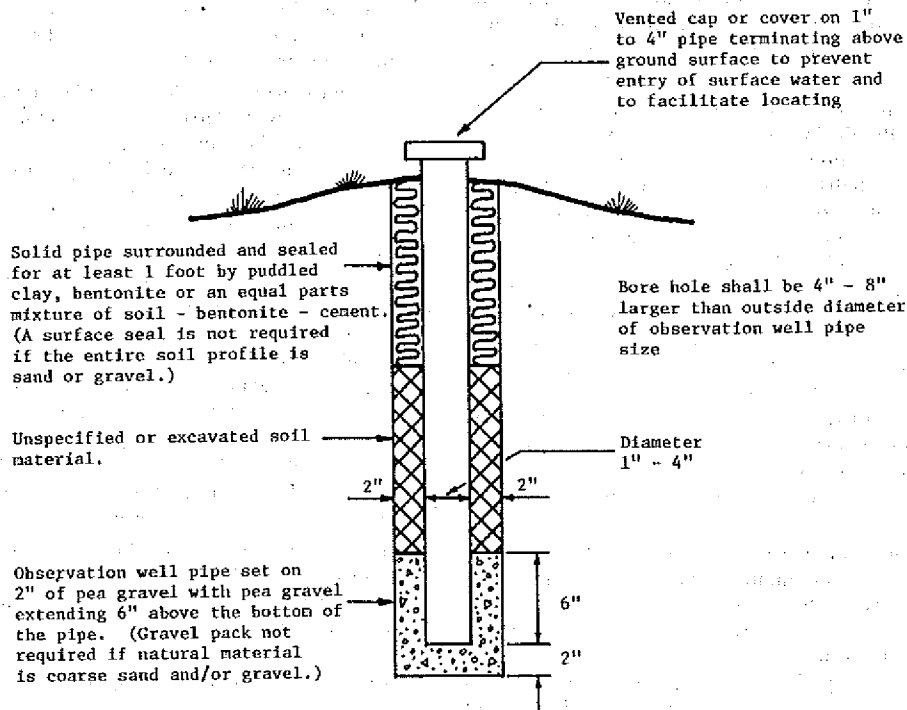

(e) *Observations.* 1. 'Minimum frequency.' The first observation shall be made on or before March 15th. Observations shall be made thereafter every 7 days or less until June 1st or until the site is determined to be unacceptable, whichever comes first. If water is observed above the critical depth at any time, an observation shall be made 1 week later. If water is present above the critical depth at both observations, monitoring may cease because the site is considered unacceptable. If water is not present above the critical depth at the second observation, monitoring shall continue until June 1st. If any 2 observations 7 days apart show the presence of water above the critical depth, the site is unacceptable and the department shall be notified in writing.

2. 'More frequent interval.' The occurrence of rainfall(s) of 1/2 inch or more in a 24 hour period during monitoring may necessitate observations at more frequent intervals.

(f) *Reporting data.* 1. 'Unsuccessful site.' When monitoring shows saturated conditions, data giving test locations, ground elevations at the wells, soil profile descriptions, soil series if avail-

able from soil maps, dates observed, depths to observed water and local precipitation data (monthly from September 1st to June 1st and daily during monitoring) shall be submitted in writing, with 2 copies sent to the department and one to the county authority.

2. 'Successful site.' When monitoring discloses that the site is acceptable, documentation including location and depth of test holes, ground elevations at the wells, soil profile descriptions; soil series if available from soil maps; dates observed; results of observations, local precipitation data (monthly from September 1st to June 1st and daily during monitoring) and information on artificial drainage shall be submitted in writing, with 2 copies to the department and one to the county authority. A request to install a soil absorption system shall be made to the department along with the appropriate review fee in s. Comm 83.08 (3) (c).

(b) *WINTER SOIL TESTING.* (a) *General.* Soil testing should be done only when weather and light conditions make accurate evaluation of site conditions possible. Soil testing attempted under winter conditions is difficult and precautions should be observed.

(b) *Soil borings.* Soil borings and profile evaluations conducted between November 15th and March 15th shall be in accord with the following procedures. Borings shall be made with a backhoe. Soil profiles shall only be evaluated between the hours of 10:00 a.m. and 2:00 p.m. Soil profiles shall not be evaluated during times when the sky is completely overcast. When soil horizons are frozen, soil material must be thawed for hand texturing.

(c) *Percolation tests.* Percolation tests that are unprotected shall be conducted only on days when the air temperature is 20° F. or higher and the wind velocity is 10 m.p.h. or less. A heated structure or other protection from freezing shall be provided when the weather conditions listed above are not met. The bottom of the percolation hole shall be at least 12 inches below frost depth. If water freezes in the test hole at any time, the test data shall be void.

History: Cr. Register, December, 1980, No. 300, eff. 1-1-81; renun. from H 63.09, Register, June, 1983, No. 330, eff. 7-1-83; cr. (4m) and (4n), r. and recr. (7) (a) and (b), Register, June, 1991, No. 426, eff. 7-1-91; r. and recr. (4n), Register, April, 1992, No. 436, eff. 5-1-92.

Comm 83.10 Site requirements. (1) SOIL ABSORPTION SITE LOCATION. The surface grade of all soil absorption systems shall be located at a point lower than the surface grade of any nearby water well or reservoir on the same or adjoining property, however, when this is not possible, the site shall be so located that surface water drainage from the site is not directed toward a well or reservoir and will by-pass the well or reservoir site by several feet. The soil absorption system shall be located not less than 5 feet from any lot line; 10 feet from a water service, or an uninhabited slab constructed building; 15 feet from a swimming pool or habitable slab constructed building measured from the slab; 25 feet from the below grade foundation of any occupied or habitable building or dwelling, public water main or cistern; 50 feet from any water well, reservoir or from the high water mark of any lake, stream or other watercourse. Private sewage systems in compacted areas such as parking lots and driveways are prohibited. Surface waters shall be diverted away from any soil absorption site on the same or neighboring lots.

(2) **GROUNDWATER, BEDROCK OR SLOWLY PERMEABLE SOILS.** There shall be a minimum of 3 feet of soil between the bottom of the soil absorption system and high groundwater, or bedrock. Soil having a percolation rate of 60 minutes per inch or faster shall exist for the depth of the proposed soil absorption system and for at least 3 feet below the proposed bottom of the soil absorption system. There shall be 56 inches of suitable soil from original grade for a conventional soil absorption system.

(3) **PERCOLATION RATE OR SOIL EVALUATION—TRENCH OR BED.** A trench or bed type soil absorption system shall not be installed if the percolation rate for any one of the 3 tests is greater than 60 minutes per inch. The soil infiltration rate listed in Table 0 or the slowest percolation rate shall be used to determine sizing of the soil absorption area.

(4) **PERCOLATION RATE OR SOIL EVALUATION—SEEPAGE PIT.** For a seepage pit, percolation tests shall be made in each horizon penetrated below the inlet pipe. Soil strata in which the percolation

rates are greater than 30 minutes per inch shall not be included in sizing the soil absorption area. The infiltration rate determined from Table 0 or the slowest percolation rate shall be used to size the soil absorption area.

(5) **SOIL MAPS.** When a parcel of land consists entirely of soils having very severe or severe limitations for on-site liquid waste disposal as determined by use of a detailed soil map and interpretive data, that map and interpretive data may be used as a basis for denial for an on-site waste disposal system. However, the property owner shall be permitted to present evidence that a suitable site for an on-site liquid waste disposal system does exist.

(6) **FILLED AREA.** (a) *Departmental approval.* A soil absorption system shall not be installed in a filled area unless written approval is received from the department except if filled prior to certification as a subdivision lot under ch. Comm 85.

(c) *Site and soil requirements.* 1. 'Bedrock.' Sites that have less than 56 inches but at least 30 inches of soil over bed-rock, where the original soil texture is sand or loamy sand (sand that has very few fine particles of silt or clay), may be filled with the same soil texture as the natural soil or coarser material up to and including medium sand in an attempt to overcome the site limitations. The fill material shall not be of a finer texture than the natural soil.

2. 'High groundwater.' Sites that have less than 56 inches of soil over high groundwater or estimated high groundwater, where the original soil texture is sand or loamy sand (sand that has very few fine particles of silt or clay), may be filled following the criteria noted in this subsection.

3. 'Natural soil.' Sites with soils finer than sand or loamy sand shall not be approved for systems in fill.

4. 'Monitoring.' Sites that will have 36 inches of soil or less above high groundwater after the topsoil is removed shall be monitored for high groundwater levels in the filled area in accordance with s. Comm 83.09 (7).

5. 'Inspection of fill.' Placement of the fill material shall be inspected by the county or the department.

(d) *Design requirements.* 1. 'Size.' A filled area shall be large enough to accommodate a shallow trench system and a replacement system. The size of the filled area shall be determined from the percolation tests or soil infiltration rate as determined from Table 0, based on natural soil and use of the building. When any portion of the trench system or its replacement is in the fill, the fill shall extend to 2 feet beyond all sides of both systems before the side slope of the fill begins.

2. 'Soil test.' Soil borings and percolation tests shall be conducted before filling to determine soil textures and depth to high groundwater or bedrock.

3. 'Topsoil.' Vegetation and topsoil shall be removed prior to filling.

4. 'Side slope.' Slopes at the edge of the filled areas can be a maximum 3 to 1 ratio, providing the 2 foot separating distance is maintained. See following sketch.

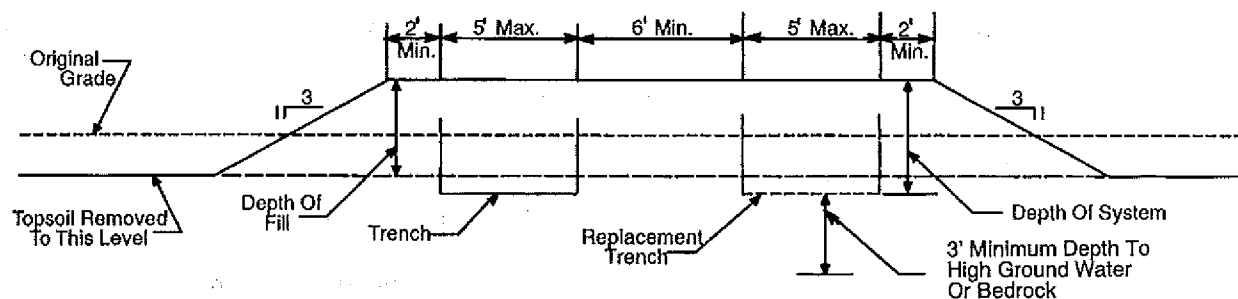

(7) ALTERING SLOPES. (a) *General*. In some cases, areas with slopes exceeding those specified in s. Comm 83.09 (3) may be graded and reshaped to provide soil absorption sites. Care must be taken when altering any natural landscapes. Successful site alteration may be accomplished in accord with the following:

(b) *Site investigation*. Soil test data shall show that a sufficient depth of suitable soil material is present to provide the required amount of soil over bedrock and groundwater after alteration. In addition, a complete site evaluation as specified in s. Comm 83.09 shall be performed after alteration of the site.

(c) *System location*. A soil absorption system must be installed in the cut area of an altered site. A soil absorption system shall not be installed in the fill area of an altered site. The area of fill on an altered site may be used as a portion of the required 20 foot separation distance from the crown of a critical slope.

There shall be a minimum of 6 feet of natural soil between the edge of a system area and the downslope side of the altered area.

(d) *Site protection*. All altered slope areas shall be altered such that surface water drainage will be diverted away from the system areas. In some cases this may require the use of grassed waterways or other means of diverting surface waters. All disturbed areas shall be seeded or sodded with grass and appropriate steps must be taken to control erosion. Conceptual design sketches for altering slopes follow.

History: Cr. Register, December, 1980, No. 300, eff. 1-1-81; renum. from H 63.10 and am. (6) (a), Register, June, 1983, No. 330, eff. 7-1-83; am. (3), (4), (6) (d) 1. and 4., Register, June, 1991, No. 426, eff. 7-1-91; r. (6) (b), Register, February, 1994, No. 458, eff. 3-1-94.

A. Excavation of complete hilltop

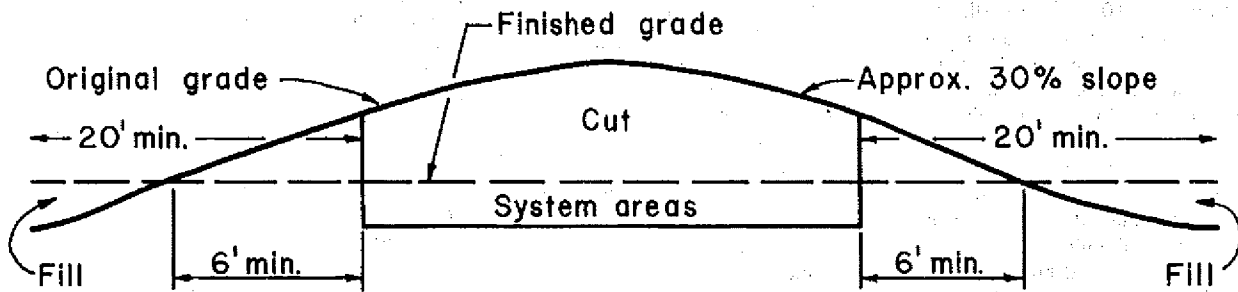

B. Excavation into hillside

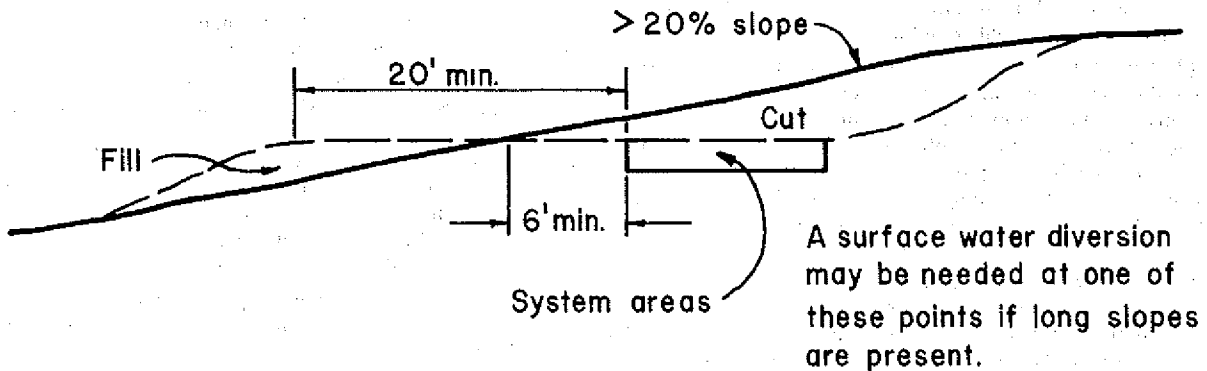

C. Regrade of hillside

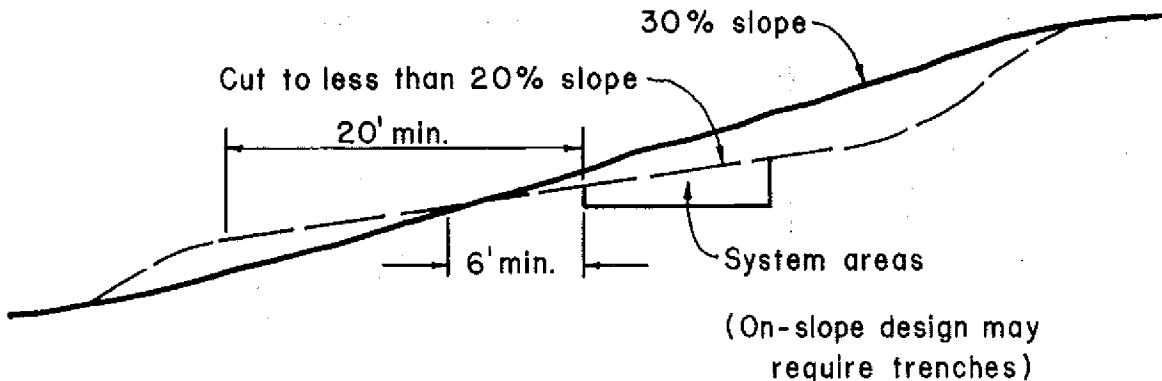

Comm 83.12 Sizing soil absorption systems.

(1) **GENERAL.** Effluent from septic tanks and other approved treatment tanks shall be disposed of by soil absorption or by such other manner approved by the department.

(a) *Daily wastewater volumes of 5,000 gallons or less.* For systems having a daily effluent application of 5,000 gallons or less, sizing shall be in accord with this section.

(b) *Daily wastewater volumes of 5,000 gallons or more.* For systems receiving effluents in excess of 5,000 gallons per day, this section shall apply except that 2 systems of equal size shall be required. Each system shall have a capacity of no less than 75% of the area required for a single system. A suitable means of alternating waste application shall be provided. The dual system shall be considered as one system.

(2) **METHOD OF DISCHARGE.** (a) *Daily flow 1,500 gallons or less.* For facilities having a daily effluent application of 1,500 gallons or less, flow from the septic or treatment tank to the soil absorption system may be by gravity or by dosing.

(b) *Systems over 1,500 gallons.* For systems over 1,500 gallons, the tank effluent must be discharged by pumping or by use of an automatic siphon.

Note: The dosing of effluents is recommended for all systems.

(3) **SIZING—RESIDENTIAL SYSTEMS.** (a) *Sizing based upon percolation tests.* The minimum amount of soil absorption area for a gravity flow system to serve a one- or 2-family dwelling based upon percolation results shall be determined in accordance with either Table 1 or Table 1a depending upon:

1. When the percolation results have been filed with the county as specified in s. Comm 83.09 (1);
2. The total number of bedrooms contained within the dwelling; and
3. The method of absorption—trench, bed or pit.

(b) *Sizing based upon soil evaluation.* The minimum amount of soil absorption area for a gravity flow system to serve a one- or 2-family dwelling based upon soil evaluation conducted in accordance with s. Comm 83.09 (4m) shall be determined by dividing the wastewater flow of 150 gallons per day per bedroom by the appropriate loading factor specified in Table 0.

**TABLE 1
MINIMUM SOIL ABSORPTION AREAS FOR ONE- AND 2-FAMILY DWELLINGS BASED UPON PERCOLATION TEST RESULTS FILED PRIOR TO JULY 1, 1991**

Percolation Rate (minutes per inch)	Minimum Absorption Area (square feet)		
	Trenches (bottom area)	Beds (bottom area)	Pits (sidewall area)
0 to less than 10	165	205	165
10 to less than 30	250	315	250
30 to less than 45	300	375	300
45 to 60	330	415	330

(4) **SIZING PUBLIC BUILDING SYSTEMS.** (a) *Sizing based upon percolation tests.* 1. The minimum amount of soil absorption area for a gravity flow system to serve a building or structure other than a one- or 2-family dwelling based upon percolation results shall depend upon:

- a. The type of occupancies or uses contained within the building or structure; and
- b. The method of absorption—trench, bed or pit.

2. The minimum amount of soil absorption area for a gravity flow system to serve a building or structure other than a one- or 2-family dwelling based upon percolation results shall be determined by using Tables 1b and 2, and the following formula:

$$\text{Minimum Soil Absorption Area (sq ft)} = (\text{Soil Absorption Area, Table 1b}) \times (\text{Factor in Column 3, Table 2}) \times (\text{Number of Units in Column 2, Table 2})$$

**TABLE 1a
MINIMUM SOIL ABSORPTION AREAS FOR ONE- AND 2-FAMILY DWELLINGS BASED UPON PERCOLATION TEST RESULTS FILED ON OR AFTER JULY 1, 1991**

Percolation Rate (minutes per inch)	Minimum Absorption Area (square feet)		
	Trenches (bottom area)	Beds (bottom area)	Pits (sidewall area)
0 to less than 10	195	240	195
10 to less than 30	275	350	275
30 to less than 45	315	390	315
45 to 60	330	415	330

(b) *Sizing based upon soil evaluation.* The minimum amount of soil absorption area for a gravity-flow system to serve a building or structure other than a one- or 2-family dwelling based upon soil evaluation conducted in accordance with s. Comm 83.09 (4m) shall be determined by dividing the appropriate wastewater flow as specified in Table 12 by the appropriate loading factor specified in Table 0.

**TABLE 1b
MINIMUM SOIL ABSORPTION AREAS FOR PUBLIC BUILDINGS AND STRUCTURES BASED UPON PERCOLATION TEST RESULTS**

Percolation Rate (minutes per inch)	Minimum Absorption Area (square feet)		
	Trenches (bottom area)	Beds (bottom area)	Pits (sidewall area)
0 to less than 10	110	140	110
10 to less than 30	165	205	165
30 to less than 45	200	250	200
45 to 60	220	280	220

TABLE 2

COLUMN 1 Building Classification	COLUMN 2 Units	COLUMN 3 Factor
Apartment building	1 per bedroom	1.5
Assembly hall—no kitchen	1 per person	0.02
Bar and cocktail lounge	1 per patron space	0.2
Beauty salon	1 per station	2.4
Bowling alley	1 per bowling lane	2.5
Bowling alley with bar	1 per bowling lane	4.5
Camp, day use only	1 per person	0.2
Camp, day and night	1 per person	0.45

COLUMN 1	COLUMN 2	COLUMN 3
Building Classification	Units	Factor
Campground and camping resort	1 per camping space	0.9
Campground and sanitary dump station	1 per camping space	0.085
Car wash (automatic)	Subject to state approval	
Car wash (per car handwash)	1 per car	1.0
Catch basin—garages, service stations, etc.	1 per basin	2.0
Catch basin—truck wash	1 per truck	5.0
Church—no kitchen	1 per person	0.04
Church—with kitchen	1 per person	0.09
Condominium	1 per bedroom	1.5
Country club	Subject to state approval	
Dance hall	1 per person	0.06
Dining hall—kitchen and toilet	1 per meal served	0.2
Dining hall—kitchen only	1 per meal served	0.06
Dining hall—kitchen and toilet waste with dishwasher and/or food waste disposer	1 per meal served	0.25
Drive-in restaurant (all paper service)	1 per car space	0.3
Drive-in restaurant (inside seating)	1 per seat	0.3
Drive-in theater	1 per car space	0.1
Employees—in all buildings	1 per person	0.4
Hotel or motel and tourist rooming house	1 per room	0.9
Floor drain	1 per drain	1.0
Hospital	1 per bed space	2.0
Medical office buildings, clinics and dental offices		
Doctors, nurses and medical staff	1 per person	0.8
Office personnel	1 per person	0.25
Patients	1 per person	0.15
Migrant labor camp—central bathhouse	1 per employe	0.25
Mobile home (single installation)	(Use Comm 83.12 (3))	
Mobile home park	1 per mobile home site	3.0
Nursing or rest homes	1 per bed space	1.0
Outdoor sports facility—toilet waste only	1 per person	0.085
Park—toilet waste only	1 per acre	4.0
Park—showers and toilets	1 per acre	8.0
Restaurant—kitchen waste only	1 per seating space	0.18
Restaurant—toilet waste only	1 per seating space	0.42
Restaurant—kitchen and toilet	1 per seating space	0.6
Restaurant—(24-hr) kitchen and toilet	1 per seating space	1.2
Restaurant—dishwasher and/or food waste disposer	1 per seating space	0.15
Restaurant—(24-hr) with dishwasher/dispenser	1 per seating space	1.5
Retail store	1 per customer	0.03
(Number of customers = 70% total area divided by 30 square feet/customer.)		
Self-service laundry—toilet wastes only	1 per machine	1.0
Auto washer (service bldgs., etc.)	1 per machine	6.0
Service station	1 per car served	0.15
Swimming pool bathhouse	1 per person	0.2
School—no meals, no showers	1 per classroom	5.0
School—meals served or showers	1 per classroom	6.7
School—meals and showers	1 per classroom	8.0
Showers—public	1 per shower	0.3

History: Cr. Register, December, 1980, No. 300, eff. 1-1-81; renum. from H 63.12, Register, June, 1983, No. 330, eff. 7-1-83; am. (3) and (4), Register, June, 1991, No. 426, eff. 7-1-91; r. and recr. (3), (4) and Table 1, cr. Tables 1a and 1b, Register, April, 1992, No. 436, eff. 5-1-92; r. (1) (c), Register, February, 1994, No. 458, eff. 3-1-94.

Comm 83.13 Installation—conventional soil absorption systems. (1) SEEPAGE TRENCH EXCAVATIONS. Seepage trench excavations shall be 1 to 5 feet in width. Trench excavations shall be spaced at least 6 feet apart. The absorption area of a seepage trench shall be computed by using the bottom area only. The bottom area of the distribution header excavation

shall not be computed as absorption area. Individual seepage trenches should not be over 100 feet long.

(2) SEEPAGE BED EXCAVATIONS. Seepage bed excavations shall be more than 5 feet wide and have more than one distribution pipe. The absorption area of a seepage bed shall be computed by using the bottom area only. Distribution piping in a seepage bed shall be uniformly spaced, no more than 6 feet and no less than 3 feet apart, and no more than 3 feet or less than 1 foot from the sidewall.

(3) SEEPAGE PITS. A seepage pit shall have a minimum inside diameter of 5 feet and shall consist of a chamber walled-up with

material such as perforated precast concrete ring, concrete block, brick or other material approved by the department which allows effluent to percolate into the surrounding soil. The pit bottom shall be left open to the soil. Aggregate of $1\frac{1}{2}$ to $2\frac{1}{2}$ inches in size shall be placed into a 6-inch minimum annular space separating the outside wall of the chamber and sidewall excavation. The depth of the annular space shall be measured from the inlet pipe to the bottom of the chamber. Each seepage pit shall be provided with a 24-inch manhole extending to within 6 inches of the ground surface and a 4-inch diameter fresh air inlet which shall meet the requirements of sub. (7). An observation pipe is not required. Seepage pits shall be located 6 feet or more apart. Excavation and scarifying shall be in accord with sub. (4). The effective area of a seepage pit shall be the vertical wall area of the walled-up chamber for the depth below the inlet for all strata for which the percolation rates are less than 30 minutes per inch. The 6 inches of annular opening outside the vertical wall area may be included for determination of effective area. Table 3 may be used for determining the effective sidewall area of circular seepage pits:

TABLE 3
EFFECTIVE ABSORPTION AREA FOR SEEPAGE PITS

Inside diameter of chamber in feet plus 1 foot for wall thickness plus one foot for annular space	Depth in feet of Permeable Strata Below Inlet					
	3	4	5	6	7	8
7	75	101	126	151	176	201
8	85	113	142	170	198	226
9	94	126	157	188	220	251
10	104	138	173	208	242	277
12	123	163	204	245	286	327

(4) **EXCAVATION AND CONSTRUCTION.** The bottom of a trench or bed excavation shall be level. Seepage trenches or beds shall not be excavated when the soil is so wet that soil material rolled between the hands will form a soil wire. All smeared or compacted soil surfaces in the side walls or bottom of the seepage trench or bed excavation shall be scarified to the depth of smearing or compaction and the loose material removed. If rain falls on an open excavation, the soil must be left until dry enough that a soil wire will not form when soil from the excavation bottom is rolled between the hands. The bottom area shall then be scarified and loose material removed.

(5) **AGGREGATE AND BACKFILL.** A minimum of 6 inches of aggregate ranging in size from $1\frac{1}{2}$ to $2\frac{1}{2}$ inches shall be laid into the trench or bed below the distribution pipe elevation. The aggregate shall be evenly distributed a minimum of 2 inches over the top of the distribution pipe. The aggregate shall be covered with synthetic materials approved by the department or with 9 inches of uncompacted marsh hay or straw. Building paper shall not be used to cover the aggregate. A minimum of 18 inches of soil backfill shall be provided above the covering.

(6) **DISTRIBUTION PIPING.** (a) *General.* Distribution piping for gravity systems shall be a minimum of 4 inch I.D. approved pipe. The distribution header shall be constructed of approved solid wall pipe. The top of the distribution piping shall be laid 8 to 42 inches below the original surface in continuous straight or curved lines. The slope of the distribution pipes shall be 2 to 4 inches per 100 feet.

(b) *Distribution of effluent.* Distribution of effluent to seepage trenches on sloping sites may be accomplished by utilizing a drop box design. Where dosing is required, the siphon or pump shall discharge a dose of minimum capacity equal to 75% of the combined volume of the distribution piping in the absorption system.

When dosing is required, the dosing frequency shall be a maximum 4 times daily.

(7) **FRESH AIR INLETS AND OBSERVATION PIPE.** Fresh air observation inlets shall be provided and connected to the perforated distribution pipe with an approved fitting or junction box and be placed so as to assure a free flow of air throughout the entire installation. The vent pipes shall be at least 4 inches in diameter and extend at least 12 inches above the final grade and terminate with an approved vent cap. The observation pipe shall be perforated and extend to the bottom of the aggregate. See following sketch. Fresh air inlets shall be located at least 25 feet from any window, door or air intake of any building used for human habitation. A maximum of 4 distribution pipe lines may be served by one common 4-inch vent when interconnected by a common header pipe.

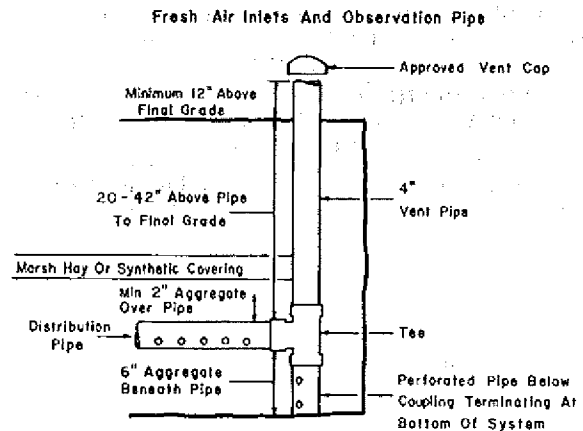

(8) **WINTER INSTALLATION.** (a) *General.* Installation of soil absorption systems during periods of adverse weather conditions is not recommended. A soil absorption system shall not be installed if the soil at the system elevation is frozen.

(b) *Removal of snow cover.* Snow cover must be removed from the soil absorption area before excavation begins. Snow must not be placed in a manner that will cause water to pond on the soil absorption system area during snowmelt.

(c) *Excavated and backfill material.* Excavated soil material may be used as backfill for the system if the following conditions are met: The excavated material must be protected from freezing. If the excavated material freezes solid, it shall not be used as backfill. The first 12 inches of backfill shall be loose, unfrozen soil. The protective covering over the bed or trench gravel shall be a synthetic material approved by the department or 9 inches of uncompacted marsh hay or straw.

(d) *System inspection.* Inspection of systems installed during winter conditions shall include inspection of the trench or bed excavation prior to placement of gravel and inspection of backfill material at the time of placement.

History: Cr. Register, December, 1980, No. 300, eff. 1-1-81; renum. from H 63.13, Register, June, 1983, No. 330, eff. 7-1-83; am. (6) (b), Register, April, 1992, No. 436, eff. 5-1-92; am. (6) (b) and (7), Register, February, 1994, No. 458, eff. 3-1-94.

Comm 83.14 Pressure distribution systems.

(1) **GENERAL.** A pressure distribution system may be used on any site meeting the criteria listed in s. Comm 83.10. There shall be a minimum depth to the top of the distribution piping of 6 inches from original grade. The minimum required suitable soil depths from original grade for a pressure distribution network are as follows:

- 1 inch distribution pipe—49 inches suitable soil
- 2 inch distribution pipe—50 inches suitable soil

- 3 inch distribution pipe—52 inches suitable soil
- 4 inch distribution pipe—53 inches suitable soil

(2) SOIL ABSORPTION AREA. (a) *Sizing.* The required soil absorption area shall be determined by dividing the total daily wastewater flow by the design loading rate.

(b) *Estimating wastewater flow.* 1. 'Residential.' The estimated wastewater flow from a residence shall be 150 gallons per bedroom per day.

2. 'Public buildings.' Daily wastewater flow rates for public buildings shall be based on the usage factors listed in s. Comm 83.15 (3) (c) 2.

(c) *Design loading rate.* 1. Loading rates based on percolation test results shall be determined using Tables 4 or 4a, depending upon when the test results were filed with the county in accordance with s. Comm 83.09 (1).

2. Loading rates based on soil evaluation conducted in accordance with s. Comm 83.09 (4m) shall be based on using Table 0.

TABLE 4
MAXIMUM DESIGN LOADING RATES BASED UPON PERCOLATION TEST RESULTS FILED PRIOR TO JULY 1, 1991

Percolation Rate (minutes per inch)	Design Loading Factor (gal/sq ft/day)
0 to less than 10	1.2
10 to less than 30	0.8

30 to less than 45	0.72
45 to 60	0.4
greater than 60 to 120	0.24 ^a

^a For mound type systems only.

TABLE 4a
MAXIMUM DESIGN LOADING RATES BASED UPON PERCOLATION TEST RESULTS FILED ON OR AFTER JULY 1, 1991

Percolation Rate (minutes per inch)	Design Loading Factor (gal/sq ft/day)
0 to less than 10	0.8
10 to less than 30	0.6
30 to less than 45	0.5
45 to 60	0.4
greater than 60 to 120	0.3 ^a

^a For mound type systems only.

(3) PRESSURE DISTRIBUTION SYSTEM DESIGN. (a) *General.* Pressure distribution systems may discharge effluent into trenches or beds. Each pipe that is connected to an outlet of a manifold shall be counted as a separate distribution pipe. The horizontal spacing of distribution pipes shall be 30 to 72 inches. (See following sketch.) All distribution piping should be installed at the same elevation, or the plans and specifications shall provide for a design that insures equal flow through each of the perforations.

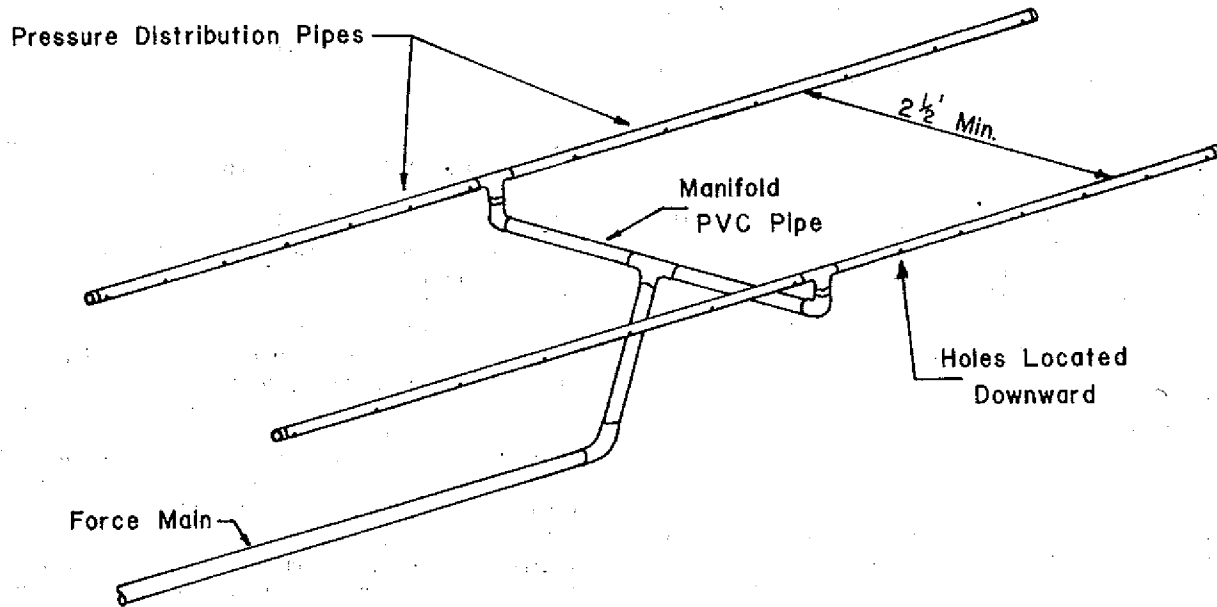

Bed Design is Recommended Over Trenches

(b) *Design calculations.* Pressure distribution systems requiring less than 5,000 square feet of absorption area shall be designed using Tables 5 through 11. Systems requiring more than 5,000 square feet of absorption area shall be designed using design specifications and calculations other than those specified in Tables 5 through 11. Design specifications and calculations must be submitted and include perforation discharge rate, total headloss

through the distribution piping, headloss through manifold piping, pump or siphon size and dosing volume. Formulas for these calculations may be obtained from the department.

(c) *Distribution pipe size.* Distribution pipe diameters may vary depending on the length of bed or trenches. Table 5 specifies maximum allowable distribution pipe lengths for various pipe and perforation sizes.

Table 5: Required Distribution Pipe Diameters For Various Hole Diameters, Hole Spacings And Distribution Pipe Lengths (for plastic pipe only)

Distribution Pipe Length (ft.)	Distribution Pipe Diameter (in.)																																						
	Hole Diameter (in.) $\frac{1}{4}$							Hole Diameter (in.) $\frac{5}{16}$							Hole Diameter (in.) $\frac{3}{8}$							Hole Diameter (in.) $\frac{7}{16}$							Hole Diameter (in.) $\frac{1}{2}$										
	Hole Spacing (ft.)							Hole Spacing (ft.)							Hole Spacing (ft.)							Hole Spacing (ft.)							Hole Spacing (ft.)										
	2	3	4	5	6	7	2	3	4	5	6	7	2	3	4	5	6	7	2	3	4	5	6	7	2	3	4	5	6	7									
10																																							
15																																							
20																																							
25																																							
30																																							
35																																							
40																																							
45																																							
50																																							

TABLE 6

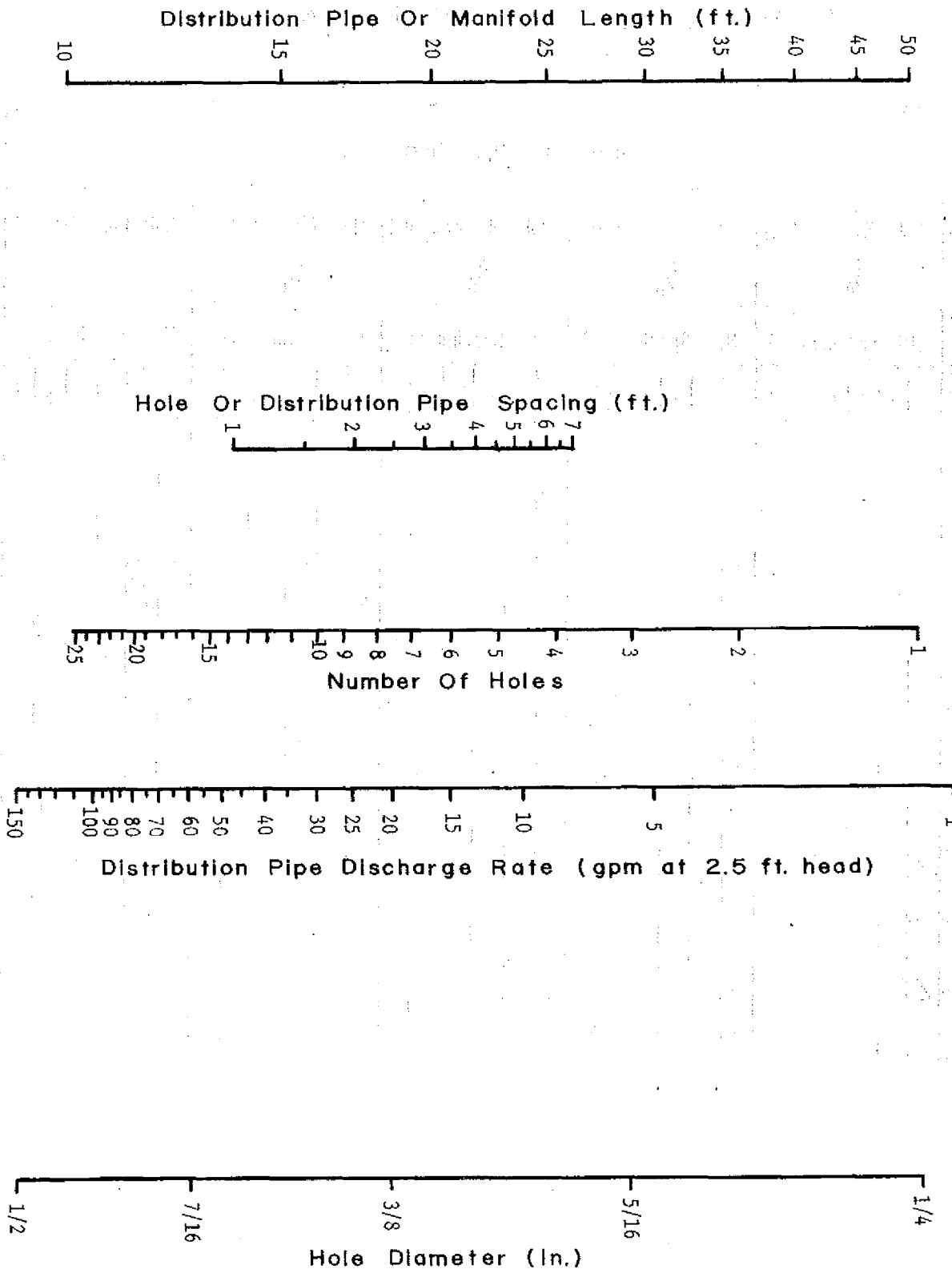

Table 7: Recommended Manifold Diameters For Various Manifold Lengths, Number Of Distribution Pipes, And Distribution Pipe Discharge Rates (for plastic pipe only)

		Manifold Diameter (in.)																	
		Manifold Length (ft.)																	
		5'	10'	15'	20'	25'	30'	35'	40'	45'	50'								
		Number Of Distribution Pipes With Central Manifold																	
		4	6	4, 6	8, 10	4, 6, 8, 10, 12	6, 8, 10, 12, 14	6, 8, 10, 12, 14	6, 8, 10, 12, 14, 16	6, 8, 10, 12, 14, 16, 18	6, 8, 10, 12, 14, 16, 18, 20	6, 8, 10, 12, 14, 16, 18, 20, 22	FLOW PER PIPE (gpm)						
Central Manifold	5	1"	1 1/4"	1 1/4"	1 1/2"	2"	1 1/4"	1 1/2"	2"	2"	2"	2"	3"	2"	3"	2"	3"	4"	10
	10	1 1/4"	1 1/2"	1 1/2"	2"	2"	2"	3"	3"	3"	3"	3"	4"	4"	4"	4"	4"	4"	20
	15	1 1/2"	2"	2"	3"	3"	3"	4"	4"	4"	4"	4"	6"	6"	6"	6"	6"	6"	30
	20	2"	3"	3"	4"	4"	4"	6"	6"	6"	6"	6"	8"	8"	8"	8"	8"	8"	40
	25	2"	3"	4"	4"	4"	4"	6"	6"	6"	6"	6"	8"	8"	8"	8"	8"	8"	50
		Number Of Distribution Pipes With End Manifold																	
		2, 3	2, 3, 4	2, 3, 4, 5	2, 3, 4, 5, 6	3, 4, 5, 6, 7	3, 4, 5, 6, 7	3, 4, 5, 6, 7	3, 4, 5, 6, 7, 8	3, 4, 5, 6, 7, 8, 9	3, 4, 5, 6, 7, 8, 9, 10	3, 4, 5, 6, 7, 8, 9, 10, 11	FLOW PER PIPE (gpm)						

(d) *Manifolds.* 1. 'Size.' The size of the manifold is based on the number, length and discharge rate of the distribution pipes. Table 6 shall be used for calculating distribution pipe discharge rate. Table 7 shall be used for calculating manifold diameter.

2. 'Distribution pipe connection.' Distribution pipes should be connected to the manifold with tee's or 90° ells. Distribution pipes shall have the ends capped.

(e) *Force main.* The size of the force main between the pump and the manifold shall be based on the friction loss and velocity of effluent through the pipe. Force mains shall be constructed of approved pipe.

(4) **BED AND TRENCH CONSTRUCTION.** (a) *General.* The excavation and construction requirements for pressure distribution system trenches and beds shall meet the requirements speci-

fied in s. Comm 83.13 (1), (2), (4), (5), (8).

(b) *Aggregate.* Aggregate shall be placed to a minimum depth of 6 inches beneath the distribution pipe with 2 inches spread evenly above the pipe. The aggregate shall be clean, non-deteriorating 1/2 to 2-1/2 inch stone.

(5) **PUMPS AND PUMP CONTROLS.** (a) *Pump selection.* Pump selection shall be based on the pump performance curve of the model selected. Pumps shall be rated by the manufacturer for use for sewage or effluent. The pump shall be capable of providing a minimum 2.5 feet of head at all of the perforations in the distribution network.

(b) *Discharge rate.* Table 8 shall be used to determine pump dosing rate based on the distribution pipe discharge rate and number of distribution pipes.

TABLE 8

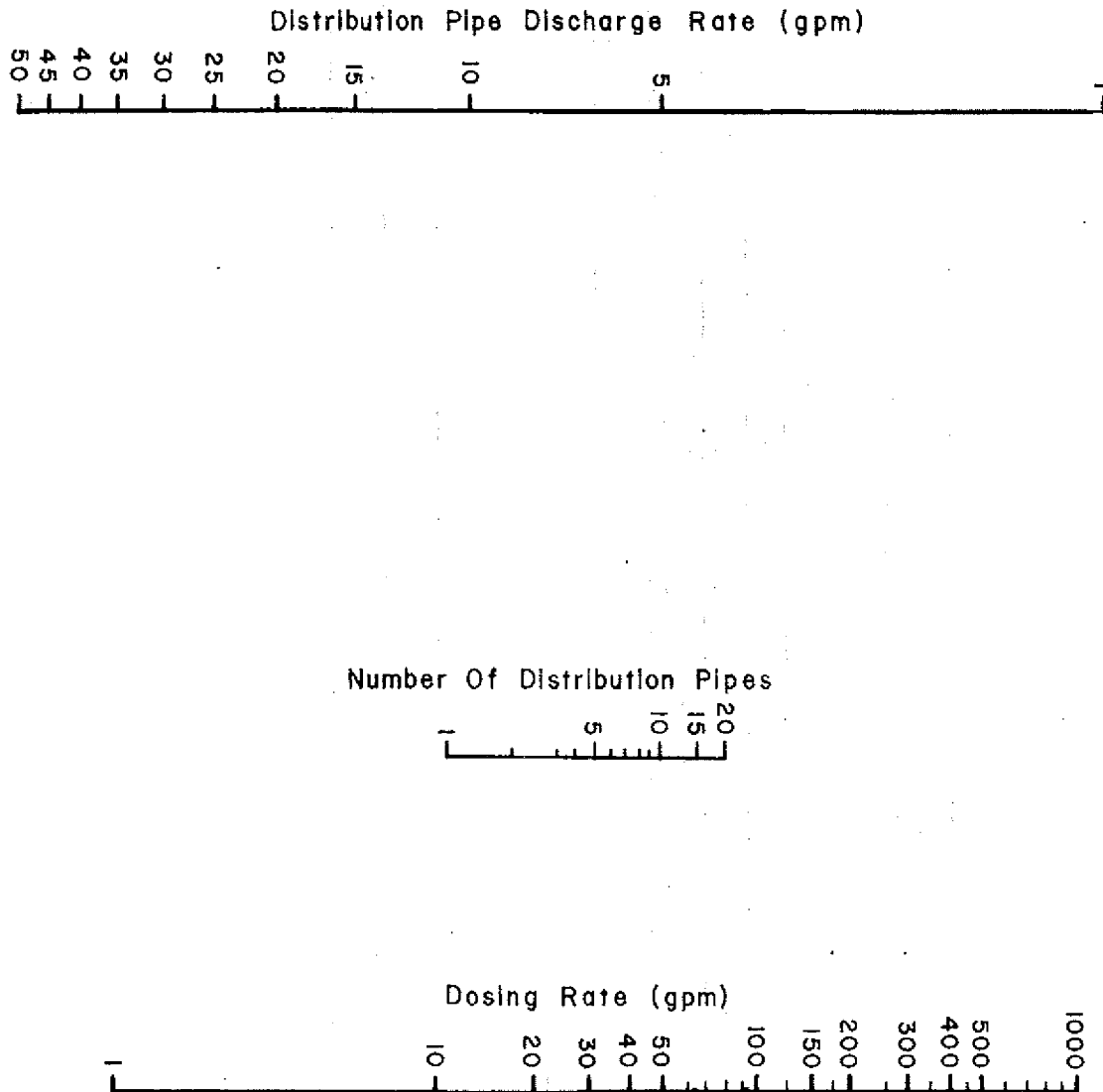

(c) *Friction loss.* Table 9 is the friction loss chart for schedule 40 plastic pipe (C = 150). The diameter of the pipe shall be increased if the velocity falls in the excessive range based upon flow rates in Table 9.

(d) *Pump and alarm controls.* 1. 'General controls.' The control system for the pumping chamber shall consist of a control for operating the pump and an alarm system to detect when the pump is malfunctioning. Pump controls should be selected which give

flexibility in adjusting the on/off depth. All pump and alarm controls shall be approved by the department. Pressure diaphragm switches shall not be used. The following types of controls may be used.

a. Mercury level control. Mercury level control switches con-

sist of a mercury switch sealed inside a bulb. Strictly an on/off switch, 2 are required.

b. Adjustable weight switch. Adjustable weight switches consist of a control located above the water level and 2 weights attached to a single cable which extends into the liquid.

TABLE 9
FRICTION LOSS IN SCHEDULE 40 PLASTIC PIPE (C = 150)

Flow gpm	Pipe Diameter (in)								
	1	1-1/4	1-1/2	2	3	4	6	8	10
	ft/100 ft								
1	0.07								
2	0.28	0.07							
3	0.60	0.16	0.07						
4	1.01	0.25	0.12						
5	1.52	0.39	0.18						
6	2.14	0.55	0.25	0.07					
7	2.89	0.76	0.36	0.10					
8	3.63	0.97	0.46	0.14					
9	4.57	1.21	0.58	0.17					
10	5.50	1.46	0.70	0.21					
11		1.77	0.84	0.25					
12		2.09	1.01	0.30					
13		2.42	1.17	0.35					
14		2.74	1.33	0.39					
15		3.06	1.45	0.44	0.07				
16		3.49	1.65	0.50	0.08				
17		3.93	1.86	0.56	0.09				
18		4.37	2.07	0.62	0.10				
19		4.81	2.28	0.68	0.11				
20		5.23	2.46	0.74	0.12				
25			3.75	1.10	0.16				
30			5.22	1.54	0.23				
35				2.05	0.30	0.07			
40				2.62	0.39	0.09			
45				3.27	0.48	0.12			
50				3.98	0.58	0.16			
60					0.81	0.21			
70					1.08	0.28			
80					1.38	0.37			
90					1.73	0.46			
100					2.09	0.55	0.07		
125						0.85	0.12		
150						1.17	0.16		
175						1.56	0.21		
200							0.28	0.07	
250							0.41	0.11	
300							0.58	0.16	
350							0.78	0.20	0.07
400							0.99	0.26	0.09
450							1.22	0.32	0.11
500								0.38	0.14
600								0.54	0.18
700								0.72	0.24
800									0.32
900									0.38
1000									0.46

Velocities in this area
become too great for the
various flow rates and
pipe diameter.

TABLE 10
VOID VOLUME FOR VARIOUS DIAMETER PIPES

Diameter (inch)	Volume (gal/ft length)
1	0.041
1¼	0.064
1½	0.092
2	0.164
3	0.368
4	0.655
6	1.47

2. 'Alarm system.' The alarm system shall consist of a bell

or light mounted in the structure and shall be located so it can be easily seen or heard. The high water warning device shall be installed 2 inches above the depth set for the on pump control. Alarm systems shall be installed on a separate circuit from the electrical service.

3. 'Electrical connections.' Electrical connections shall be located outside the pumping chamber. All wiring to the pump chamber shall be installed in a conduit.

4. 'Duplex pumps.' When 2 or more pumps are employed within a dosing tank, the pumps shall be interconnected such that the pumps alternate dosing, and dosing continues in the event that one pump fails. Failure of a pump shall activate an alarm which is to remain audible or visible until manually turned off.

TABLE 11

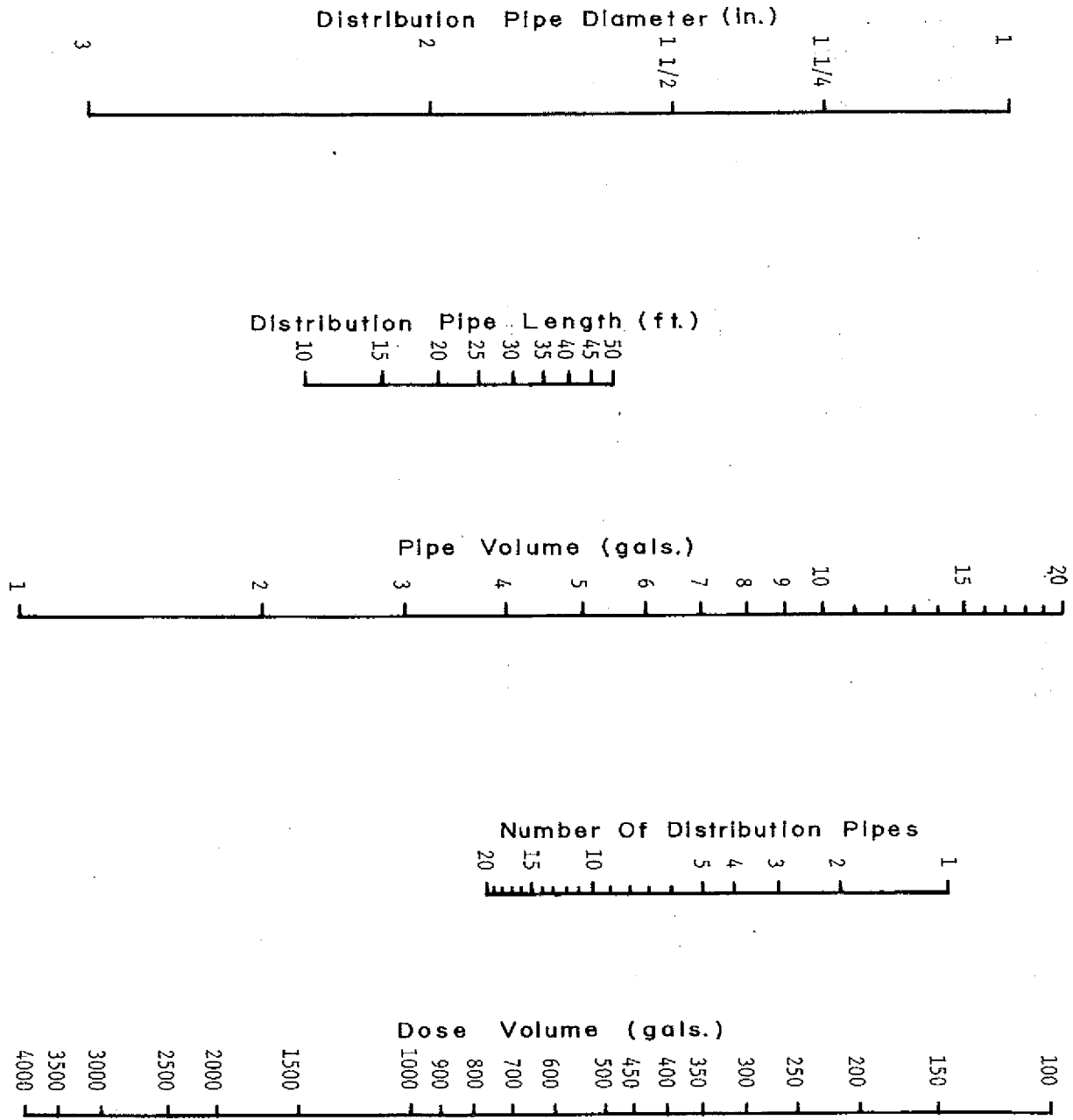

(6) **DOSING.** The dosing frequency shall be a maximum of 4 times daily. To establish the volume per dose, divide the daily wastewater flow by the dosing frequency. In addition, the dosing volume shall be at least 10 times the capacity of the distribution pipe volume. Table 10 provides the void volume for various pipe diameters. Table 11 shall be used to determine minimum dose volume based on distribution pipe diameter, length and number of distribution pipes.

History: Cr. Register, December, 1980, No. 300, eff. 1-1-81; renum. from H 63.14, Register, June, 1983, No. 330, eff. 7-1-83; am. (2) (a), r. and recr. (2) (c), Register, June, 1991, No. 426, eff. 7-1-91; r. and recr. (2) (a), (c), (5) (a) and Table 4, cr. (5) (d) 4. and Table 4a, Register, April, 1992, No. 436, eff. 5-1-92; am. (1), r. (4) (c), Register, February, 1994, No. 458, eff. 3-1-94.

Comm 83.15 Septic tanks and other treatment tanks. (1) **GENERAL.** Septic tanks shall be fabricated or constructed of welded steel, monolithic concrete, fiberglass or other materials approved by the department. All tanks shall be watertight and fabricated so as to constitute an individual structure. The design of prefabricated septic tanks shall be approved by the department. Plans for site-constructed concrete tanks shall be approved by the department prior to construction.

(2) **DESIGN OF SEPTIC TANKS.** (a) *Liquid depth.* The liquid depth shall not be less than 3 feet nor more than an average of 6 feet. The total depth shall be at least 8 inches greater than the liquid depth.

(b) *Rectangular tanks.* Rectangular tanks shall have a minimum width of 36 inches and shall be constructed with the longest dimensions parallel to the direction of flow.

(c) *Cylindrical tanks.* Cylindrical tanks shall have an inside diameter of not less than 48 inches.

(d) *Label.* Each prefabricated tank shall be clearly marked to show liquid capacity and the name and address or registered trade mark of the manufacturer. The markings shall be impressed into or embossed onto the outside wall of the tank immediately above the outlet opening. Each site-constructed concrete tank shall be clearly marked at the outlet opening to show the liquid capacity. The marking shall be impressed into or embossed onto the outside wall of the tank immediately above the outlet opening.

(e) *Materials.* For septic tank material and construction specifications, see s. Comm 83.20.

(f) *Inlet and outlet.* The inlet and outlet on all tanks or tank compartments shall be provided with open-end coated sanitary tees or baffles made of approved materials, so constructed as to distribute flow and retain scum in the tank or compartments. The inlet and outlet openings on all tanks shall contain a "boss" stop or other provision which will prevent the insertion of the sewer piping beyond the inside wall of the tank. The tees or baffles shall extend at least 6 inches above and 9 inches below the liquid level, but not to exceed 1/3 the liquid depth. At least 2 inches of clear space shall be provided over the top of the baffles or tees. The bottom of the outlet opening shall be at least 2 inches lower than the bottom of the inlet.

(g) *Manholes.* 1. Each single-compartment tank and each unit of a multi-compartment tank shall be provided with at least one manhole opening located over either the inlet or outlet opening.

2. Manholes and manhole risers for tanks shall provide an inside clearance of no less than 24 inches in diameter.

3. A manhole or top of a manhole riser for a tank shall terminate either:

- a. At or below final grade, but no deeper than 6 inches; or
- b. At least 4 inches above final grade.

4. a. Tanks of steel and fiberglass shall be provided with collars to accommodate manhole risers or extensions.

b. Collars for steel tanks and fiberglass tanks shall be of the same material as the tank.

c. Collars for steel tanks and fiberglass tanks shall be at least 2 inches in height.

d. Collars for steel tanks shall be permanently welded to the tank.

e. Collars for fiberglass tanks shall be an integral part of the tank.

(h) *Manhole covers.* 1. Manhole risers for tanks shall be provided with a substantial, fitted, watertight cover.

2. Manhole tank covers that are not buried shall have locking devices.

3. a. Manhole covers for tanks shall have warning labels printed in red or other contrasting color affixed to the manhole covers.

b. The wording used on the warning label shall clearly indicate the hazards present when entering a sewage or other treatment tank.

4. Covers, locking devices and warning labels shall be reviewed and approved as specified in s. Comm 84.10.

(i) *Inspection opening.* An inspection pipe shall be provided directly over any inlet baffle or outlet baffle for a tank compartment over which a manhole opening is not provided. An inspection pipe shall:

1. Be of a material as listed in s. Comm 84.30 (2) for vent systems;

2. Be at least 4 inches in diameter;

3. Terminate at least 6 inches above the adjacent final grade; and

4. Terminate with a removable watertight cap or plug.

(3) **CAPACITY AND SIZING.** (a) *Minimum capacity.* The capacity of a septic tank or other treatment tank shall be based on the number of persons using the building to be served or upon the volume and type of waste. The minimum liquid capacity shall be 750 gallons.

(b) *Multiple tanks.* When the required capacity is to be provided by more than one tank, the minimum capacity of any tank shall be 750 gallons. When 3 or 4 tanks are installed, approval of the design of the system shall be obtained from the department. The installation of more than 4 tanks in series is prohibited. Installation of septic tanks in parallel is prohibited.

(c) *Sizing of tank.* 1. 'Residential.' The minimum liquid capacity for one- and 2-family residences is as follows:

SEPTIC TANK CAPACITY ONE- AND TWO-FAMILY RESIDENCES	
Number of Bedrooms	Septic Tank
1	750
2	750
3	975
4	1,200
5	1,425
6	1,650
7	1,875
8	2,100

2. 'Public buildings.' For buildings other than one and two family residences the liquid capacity shall be increased above the 750-gallon minimum as established in Table 12. For such buildings having kitchen and/or laundry waste, the tank capacity shall be increased to receive the anticipated volume for a 24-hour period from the kitchen and/or laundry. The liquid capacities established in Table 12 do not include employees.

TABLE 12

Apartment buildings (per bedroom—includes auto washer)	150 gals.
Assembly hall (per person—no kitchen)	2 gals.
Bars and cocktail lounges (per patron space)	9 gals.
Beauty salons (per station—includes customers)	140 gals.
Bowling alley (per alley)	125 gals.
Bowling alley with bar (per alley)	225 gals.
Campgrounds and camping resorts (per camp space)	100 gals.
Campground sanitary dump stations (per camp space) (omit camps spaces with sewer connection)	5 gals.
Camps, day use only—no meals served (per person)	15 gals.
Camps, day and night (per person)	40 gals.
Car wash (automatic)—subject to state approval	
Car wash (per car handwash)	50 gals.
Catch basins—garages, service stations, etc.(per basin, etc.)	100 gals.
Catch basins—truck washing (per truck)	100 gals.
Churches—no kitchen (per person)	3 gals.
Churches—with kitchen (per person)	7.5 gals.
Condominiums (per bedroom—includes auto washer)	150 gals.
Country clubs—subject to state approval	
Dance halls (10 sq. ft. per person)	3 gals.
Dining hall—kitchen and toilet waste—with dishwasher and/or with disposer (per meal served)	11 gals.
Dining hall—kitchen waste only (per meal served)	3 gals.
Drive-in restaurants—all paper service (per car space)	15 gals.
Drive-in restaurants—all paper service inside seating (per seat)	15 gals.
Drive-in theaters (per car space)	5 gals.
Employee—in all buildings, per employee—total all shifts	20 gals.
Floor drain (per drain)	50 gals.
Hospitals (per bed space)	200 gals.
Hotels or motels and tourist rooming houses (per room—2 persons per room)	100 gals.
Medical office buildings, clinics and dental offices	
Doctors, nurses, medical staff (per person)	75 gals.
Office personnel (per person)	20 gals.
Patients (per person)	10 gals.
Migrant labor camp, central bathhouse (per employee)	30 gals.
Mobile homes, single installation (use Comm 83.15 (3) (c) 1.)	
Mobile home parks, homes with bathroom groups (per site)	300 gals.
Nursing and rest homes—without laundry (per bed space)	100 gals.
Outdoor sport facilities (toilet waste only—per person)	5 gals.
Parks, toilet wastes (per person—75 persons per acre)	5 gals.
Parks, with showers and toilet wastes (per person—75 persons per acre)	10 gals.
Restaurant—kitchen waste only—without dishwasher and/or disposer (per seat)	9 gals.
Restaurant—toilet waste only (per seat)	21 gals.
Restaurant—kitchen and toilet wastes (per seating space)	30 gals.
Restaurant (24-hr)—kitchen and toilet wastes (per seating space)	60 gals.
Restaurant—dishwasher and/or food waste disposer (per seat)	3 gals.
Restaurant (24-hr)—dishwasher and/or food waste disposer (per seat)	6 gals.
Retail store—customers (Number of customers = 70% total area divided by 30 square feet/customer.)	1.5 gals.
Schools (per classroom—25 pupils per classroom)	450 gals.
Schools with meals served (per classroom—25 pupils per classroom)	600 gals.
Schools with meals served and showers provided (per classroom)	750 gals.
Self-service laundries (toilet waste only, per machine)	50 gals.
Auto washer (apartments, service buildings, etc.—per machine)	300 gals.
Service stations (per car)	10 gals.
Showers—public (per shower taken)	15 gals.
Swimming pool bathhouses (per person)	10 gals.

(4) **INSTALLATION.** (a) *Location.* 1. The location of sewage treatment tanks and pump and siphon tanks shall be in conformance with the setback distances listed in Table 12m.

2. a. A sewage treatment tank may not be located within a building or under a building, except as permitted in subpar. b.

b. A sewage treatment tank and pump or siphon tank may be located either under a cantilevered portion of a building or under an unenclosed deck structure, if at least 5 feet of vertical clearance for servicing purposes is provided between the top of the manhole and the obstruction.

3. No structural supports of buildings, portions of buildings, decks or porches may rest upon any portion of a sewage or other treatment tank.

Note: Pump and siphon tanks are commonly referred to as dosing tanks.

TABLE 12m

MINIMUM SETBACK DISTANCES FOR TREATMENT TANKS, PUMP AND SIPHON TANKS, SERVICING SUCTION LINES AND PUMP DISCHARGE LINES

Setback Element	Horizontal Distance (feet)
All Structures, Swimming Pools ^a	5
Lot or Property Line	2
Underground Water Supply System and Cistern	10
Well ^b , High Water Mark of Lake, Stream, Pond, Flowage or Reservoir	25

^aAll structures include any building and portions of buildings with any type of foundation. Swimming pools include above ground and below ground pools.

^bFor location of wells, public, private or high capacity, reference should be made to ch. NR 812. For floodplains, refer to s. Comm 83.18 (9).

(b) *Groundwater.* If the tank is installed in groundwater, adequate anchoring provisions shall be made.

(c) *Bedding.* A 3-inch thick compacted bedding shall be provided for all septic and other treatment tank installations. The bedding material shall be sand, gravel, granite, limerock or other non-corrosive materials of such size that 100% will pass a 1/2-inch screen.

(d) *Backfill.* 1. 'Steel and fiberglass tanks.' The backfill material for steel and fiberglass tanks shall be as specified for bedding and shall be tamped into place, care being taken to prevent damage to the coating.

2. 'Concrete tanks.' The backfill for concrete tanks shall be soil material, 100% of which shall pass a 4-inch screen and shall be tamped into place.

(e) *Manhole riser joints.* 1. 'Concrete.' All joints on concrete risers and manhole covers shall be tongue and groove or shiplap type and sealed watertight using neat cement, mortar or bituminous compound.

2. 'Steel.' All joints on steel risers shall be welded or flanged and bolted and be watertight. All steel manhole extensions shall be bituminous coated inside and outside.

3. 'Fiberglass.' All methods of attaching fiberglass risers shall be watertight and approved by the department.

(5) **DOSING TANKS.** (a) *Material and construction.* 1. 'Dosing tanks.' Dosing tanks shall be watertight and constructed of materials as specified in s. Comm 83.20.

2. 'Review and approval.' The design of site-constructed dosing tanks shall be reviewed and approved by the department prior to installation in accordance with s. Comm 83.08.

3. 'Manholes.' a. A dosing tank shall be provided with a manhole opening as specified in sub. (2) (g).

b. The dosing tank manhole cover shall terminate no less than 4 inches above grade and be provided with both a locking device and warning label as specified in sub. (2) (h) 1. to 3.

4. 'Label.' A dosing tank shall be labeled in accordance with sub. (2) (d).

(b) *Capacity and sizing of pump tanks.* The minimum liquid capacity of a dosing tank or a dosing tank compartment employing one pump shall be determined from the distance between the bottom of the tank and the level of the inlet pipe to accommodate the cumulative volumes as specified in subds. 1. to 4. The minimum liquid capacity of dosing tank or dosing tank compartment employing multiple pumps shall accommodate the cumulative volumes as specified in subds. 2. to 4.

1. A reserve capacity shall be provided above the high-water alarm that is at least equal to the daily wastewater discharged from the building served. This volume shall be determined for one- and 2-family residences based on 100 gallons per bedroom, or by using Table 12 for other uses.

2. The dose volume shall be provided as determined by the system type as specified in s. Comm 83.13 (6) (b) or 83.14 (6).

3. A liquid volume between the pump "on" setting and the alarm float level shall be provided.

4. A liquid volume shall be provided as calculated from the bottom of the tank to the pump "off" setting.

(c) *Capacity and sizing of siphon tanks.* The minimum liquid capacity of a dosing tank employing a siphon shall be sufficient to accommodate volumes necessary to provide dosing as specified by the system type.

(d) *Venting.* 1. A dosing tank or a dosing tank compartment shall be provided with a vent that:

a. Is sized in accordance with Table 82.31-4, but not less than 2 inches in diameter; and

b. Is of a material listed in s. Comm 84.30 (2).

2. Except as provided in subd. 3., a vent serving a dosing tank or dosing tank compartment shall:

a. Terminate at least 12 inches above the adjacent final grade;

b. Terminate with a vent cap or return bend; and

c. Be located at least 10 feet horizontally from any door, window or fresh air intake.

Note: Rules of other federal or state agencies may specify greater separation distances between vents and fresh air intakes for hospitals and nursing homes.

3. A vent serving a dosing tank or a dosing tank compartment may:

a. Connect to the venting system serving a building or a structure, in which case the vent shall conform with the requirements specified in s. Comm 82.31 (15) and (16); or

b. Be attached to the exterior of a building or a structure, in which case the vent shall conform with the requirements specified in s. Comm 82.31 (16) (a) to (e).

(6) **DESIGN OF OTHER SEWAGE TREATMENT TANKS.** Other types of sewage treatment tanks shall be constructed in accordance with s. Comm 83.20. Designs for site-constructed tanks shall be reviewed and approved by the department prior to installation in accordance with s. Comm 83.08. Designs for prefabricated tanks shall be reviewed and approved by the department in accordance with s. Comm 84.10.

History: Cr. Register, December, 1980, No. 300, eff. 1-1-81; renum. from H 63.15, Register, June, 1983, No. 330, eff. 7-1-83; am. (4) (c), Register, February, 1985, No. 350, eff. 3-1-85; r. and recr. (2) (g) to (i), (4) (a), (5), (6), cr. Table 12m, r. (4) (e) and Table 13, renum. (4) (f) to be (4) (e), Register, April, 1992, No. 436, eff. 5-1-92; am. (2) (i) 1. and (5) (d) 1. b., Register, February, 1994, No. 458, eff. 3-1-94.

Comm 83.16 Maintenance and sludge disposal.

(1) **MAINTENANCE.** Septic tanks and other treatment tanks shall be cleaned whenever the sludge and scum occupies 1/3 of the

tank's liquid capacity. All sludge, scum, liquid and any other material removed from a private domestic sewage treatment and disposal system is hereafter referred to as sludge.

(2) **SLUDGE DISPOSAL.** See ch. NR 113, Wis. Adm. Code.

(3) **COUNTY OPTION.** Counties may establish a mandatory maintenance program to insure continuing maintenance of private sewage systems.

History: Cr. Register, December, 1980, No. 300, eff. 1-1-81; renum. from H 63.16, Register, June, 1983, No. 330, eff. 7-1-83.

Comm 83.17 Chemical restoration. No products for chemical restoration or chemical restoration procedures for private sewage systems may be used unless approved by the department.

History: Cr. Register, December, 1980, No. 300, eff. 1-1-81; renum. from H 63.17, Register, June, 1983, No. 330, eff. 7-1-83.

Comm 83.18 Holding tanks. (1) APPROVAL. Plans shall be submitted in accordance with ss. Comm 83.07 and 83.08, for each application to install a holding tank. An application for a holding tank shall not be approved, if:

(a) Any other type of private sewage system may be utilized as permitted under this chapter or ch. 145, Stats.; and

(b) The property contains an area of soil suitable for any other type of private sewage system as permitted under this chapter.

(2) **PROHIBITION OF HOLDING TANKS. (a) Department.** 1. The department may prohibit the installation and use of holding tanks for new construction in areas where:

a. The methods of final disposal of septage from existing holding tanks are not in compliance with the rules adopted under s. 146.20 (4g), Stats.;

b. There is insufficient disposal capacity for the septage at wastewater treatment facilities or land disposal sites;

c. Previously installed holding tanks have been found not to be watertight by the department or county due to geological conditions;

d. The county has failed to provide to the department accurate annual pumping reports required under sub. (4) (a) 3.; or

e. The results of the department's audits under s. 145.20 (3), Stats., indicate that sanitary permits have been issued for holding tanks in violation of sub. (1).

2. A departmental prohibition for the installation and use of holding tanks shall be established by departmental orders in accordance with s. 145.20 (3) (f), Stats. The order shall specify the conditions which must be corrected before the order will be lifted.

(b) **Local.** 1. A county may prohibit by ordinance the installation and use of holding tanks for new construction. If a county does not prohibit the installation and use of a holding tank for new construction, then any city, village or town within that county may prohibit by ordinance the installation and use of holding tanks for new construction.

2. An ordinance adopted under subd. 1. may prohibit the installation and use of holding tanks for specific building occupancies or specific geographical areas.

3. Before adopting an ordinance prohibiting the installation and use of holding tanks for new construction the local governmental unit shall submit a copy of the proposed ordinance to the department for review.

4. If a local governmental unit prohibits the installation and use of holding tanks for new construction, the local governmental unit shall establish an appeal procedure to the prohibition. Under the appeal procedure the local governmental unit may grant variances to the prohibition. The local governmental unit shall inform the department in writing of each variance granted.

(3) **HOLDING TANKS ON PROPERTIES WITH EXISTING BUILDINGS.** When the use of a holding tank becomes the only available alternative for the disposal of sanitary liquid waste for an existing

building, local government shall allow the use of a holding tank or condemn the property. The requirements established for use of holding tanks for newly developed properties in this section shall also apply to replacement system uses.

(4) **SERVICING CONTRACTS, AGREEMENTS AND STATEMENTS. (a)** 1. Prior to the issuance of a sanitary permit for the installation of a holding tank the owner of the holding tank shall, except as provided by s. 146.20 (3) (d), Stats., contract with a person who is licensed under ch. NR 113 to have the holding tank serviced. The owner shall file a copy of the contract or their registration with the local governmental unit which has signed the pumping agreement under par. (b) and with the county. The owner shall file a copy of any changes to the service contract or a copy of a new service contract with the local governmental unit within 10 business days from the date of change to the service contract.

Note: Section 146.20, Stats., relates to the servicing of septic tanks, soil absorption fields, holding tanks, grease traps and privies.

2. The person responsible for servicing a holding tank under subd. 1. shall submit to the local governmental unit which has signed the pumping agreement under par. (b) and to the county a report for the servicing on a semiannual basis. The service report shall include:

a. The name and address of the person responsible for servicing the holding tank;

b. The name of the owner of the holding tank;

c. The location of the property on which the holding tank is installed;

d. The sanitary permit number issued for the holding tank;

e. The dates on which the holding tank was serviced;

f. The volumes in gallons of the contents pumped from the holding tank for each servicing; and

g. The disposal sites to which the contents from the holding tank were delivered.

3. The county shall submit to the department an annual report summarizing the semiannual service reports which it is required to receive under subd. 2.

(b) 1. The owner of a holding tank shall enter into agreement with the appropriate county, city, village or town guaranteeing that the county or local governmental unit which signed the agreement will service the holding tank, if the owner fails to have the holding tank properly serviced in response to orders issued by the department, county or local governmental unit to prevent or abate a nuisance as described in ss. 146.13 and 146.14, Stats.

2. The owner or agent shall submit a copy of the pumping agreement required under subd. 1. to the department when plans for the proposed holding tank are submitted to the department for review under s. Comm 83.08.

3. The pumping agreement required under subd. 1. shall be binding upon the owner, the heirs of the owner and assignees of the owner. The owner shall file the pumping agreement with the register of deeds. Upon receipt of a holding tank agreement, the register of deeds shall record the agreement in a manner which will permit the existence of the agreement to be determined by reference to the property where the holding tank is installed.

(c) The owner of a building or facility which will discharge more than 3,000 gallons of wastewater per day, as determined under s. Comm 83.15 (3) (c) 2., to one or more holding tanks shall provide a written statement to the department describing the method of final disposal for the septage from the holding tanks. The department may not approve these types of holding tanks until the department receives written verification that the proposed methods of final disposal are acceptable to the department of natural resources. The department shall notify the department of natural resources when a system of this type is approved.

(5) **SIZING. (a) One- and 2-family residences.** The minimum liquid capacity of a holding tank for one- and 2-family residences is as follows:

Number of Bedrooms	Holding Tank
1	2,000
2	2,000
3	2,000
4	2,500
5	3,000
6	3,500
7	4,000
8	4,500

(b) *Public buildings.* Public buildings shall have a minimum 5-day holding capacity, but not less 2,000 gallons. Sizing shall be based in accord with s. Comm 83.15 (3) (c) 2. The 750 gallon minimum referred to in s. Comm 83.15 (3) does not apply to holding tanks. No more than 4 holding tanks installed in series will be permitted.

(6) *CONSTRUCTION.* Holding tanks shall be constructed of welded steel, monolithic concrete, glass-fibre reinforced polyester or other materials approved by the department.

(7) *INSTALLATION.* (a) *Location.* 1. Holding tanks shall be located in conformance with the setback distances listed in Table 12m.

2. The service port or manhole cover of a holding tank shall be located no more than 25 feet from a service drive or road.

(b) *Warning device.* A high water warning device shall be installed so that it activates 1 foot below the inlet pipe. This device shall be either an audible or illuminated alarm. If the latter, it shall be conspicuously mounted. Electrical junction box, including warning equipment junctions, shall be located outside the holding tank unless they are housed in waterproof, explosion-proof enclosures. Electrical relays or controls shall be located outside the holding tank.

(c) *Manholes.* Each tank shall be provided with a manhole opening no less than 24 inches square or 24 inches inside diameter extending to a minimum of 4 inches above ground. Finish grade must be sloped away from the manhole to divert surface water from the manhole. Each manhole cover shall have an effective locking device. Manhole covers may have a service port reduced in size to 8 inch inside diameter 4 inches above finish grade level. The reduced opening must have an effective locking cover or a brass cleanout plug. Reduced locking devices or clean-outs must be approved by the department.

(d) *Septic tank.* If an approved septic tank is installed to serve as a holding tank, the inlet and outlet baffle may be removed and the outlet shall be sealed.

(e) *Vent.* 1. A holding tank shall be provided with a vent that:

- a. Is not less than 2 inches in diameter; and
- b. Is of a material listed in s. Comm 84.30 (2).

2. Except as provided in subd. 3., a vent serving a holding tank shall:

- a. Terminate at least 12 inches above the adjacent final grade;
- b. Terminate with a vent cap or return bend; and
- c. Be located at least 10 feet horizontally from any door, window or fresh air intake.

Note: Rules of other federal or state agencies may specify greater separation distances between vents and fresh air intakes for hospitals and nursing homes.

3. A vent serving a holding tank may:

a. Connect to the venting system serving a building or a structure, in which case the vent shall conform with the requirements specified in s. Comm 82.31 (15) and (16); or

b. Be attached to the exterior of a building or a structure, in which case the vent shall conform with the requirements specified in s. Comm 82.31 (16) (a) to (e).

(f) *Servicing.* Holding tanks shall be serviced in accord with ch. 146, Stats., and ch. NR 113, Wis. Adm. Code.

(8) *SERVICE SUCTION AND DISCHARGE LINES.* (a) A service suction line or discharge line serving a holding tank for servicing purposes shall:

1. Be constructed of piping materials in accordance with ch. Comm 84;
2. Terminate with a service port consisting of a quick disconnect fitting with a removable plug;
3. Have the service port of the suction line terminate at least 2 feet above final grade;
4. Have the service port identified as a sewage suction line with a permanent sign with lettering at least 12 inches in height;
5. Have the service port secured to a permanent support;
6. Be protected against frost in accordance with s. Comm 82.30 (11) (b), unless the entire length of the line is drained after each pumping of the tank; and
7. Be at least 3 inches in diameter.

(b) A suction line serving a holding tank may not be installed such that the tank can be drained by gravity or by siphonic action.

(c) Where a lift station is employed for servicing the holding tank, the pump discharge line shall conform with par. (a), except that:

1. The discharge line shall be at least 2 inches in diameter; and
2. The lift station pump shall be activated by means of a keyed-switch at the service port.

(9) *TANK IN FLOODPLAIN.* (a) *Vent.* A vent serving a holding tank located in a floodplain shall terminate at least 2 feet above the established regional flood elevation.

(b) *Anchoring.* Anchoring of a holding tank located in a floodplain shall be provided to counter buoyant forces caused by a regional flood or periodic saturated soil conditions using the following formula:

$$\text{Weight of the tank plus the weight of the anchor} = 1.5 \times (\text{volume of water the tank displaces}) \times [\text{the weight of water (62.4 pounds/cubic foot at } 39^{\circ}\text{F)}]$$

(c) *Manhole.* For a holding tank located in a floodplain:

1. At least 2 feet of elevation shall be provided between the top of the service manhole of a holding tank and the recorded regional flood elevation; or

2. A watertight manhole cover or service port shall be provided which is threaded or bolted to the riser.

(10) *METERING.* (a) New buildings and new structures to be served by holding tanks shall include the installation of water meters to measure the flows of the water supplies to allow comparisons to the data of holding tank pumping reports.

(b) A water meter required under par. (a) shall be installed in accordance with s. Comm 82.40 (3) (e).

History: Cr. Register, December, 1980, No. 300, eff. 1-1-81; renun. from H 63.18, Register, June, 1983, No. 330, eff. 7-1-83; emerg. r. and recr. (1), (2) and (4) off. 3-6-85; r. and recr. (1), (2) and (4), Register, September, 1985, No. 357, eff. 10-1-85; r. and recr. (7) (a), (e) and (8), cr. (9), Register, April, 1992, No. 436, eff. 5-1-92; am. (1) (intro.) and (7) (e) 1.b., cr. (10), Register, February, 1994, No. 458, eff. 3-1-94.

Comm 83.19 Inspections. (1) Pursuant to s. 145.20 (2)

(d), Stats., no part of a private sewage system may be covered by backfill until the county or the department has had an opportunity to inspect the system in accordance with this section.

(a) The plumber responsible for the installation of a private sewage system shall notify the county when the system is ready for inspection. The notification shall be in person, in writing, or by telephone or electronic communication.

(b) The plumber shall be responsible for maintaining records of the inspection notifications. The records shall include information relative to the date and time of notification and the person contacted.

(c) If an inspection is not made by the end of the next workday, excluding Saturdays, Sundays and holidays, after notifying the county, the plumber may proceed with the installation of the system, including backfilling.

(2) Pursuant to s. 145.20 (2) (g), Stats., a county by ordinance may require other inspections in addition to that specified in sub. (1).

(3) (a) A county shall maintain a written record of each inspection conducted for a private sewage system. The record shall include information relative to:

1. The location of the system;
2. The date and time of the inspection;
3. The nature and findings of the inspection.

(4) A county shall make available to the department upon request inspection records for private sewage systems.

History: Cr. Register, December, 1980, No. 300, eff. 1-1-81; renum. from H 63.19, Register, June, 1983, No. 330, eff. 7-1-83; r. and recr. Register, February, 1994, No. 458, eff. 3-1-94.

Comm 83.20 Materials. (1) **MINIMUM STANDARDS.** (a) *Approval.* Unless otherwise provided for in this chapter, all materials, fixtures or devices sold, used or entering into the construction of a private sewage system or parts thereof, shall be submitted to the department for approval and shall conform to approved applicable standards or to other equivalent standards acceptable to the department and shall be free from defects.

(b) *Identification.* Each length of pipe and each pipe fitting, fixture, material and device used in a private sewage system shall have cast, embossed, stamped or indelibly marked on it the maker's mark or name, the weight and quality of the product or identified in accord with the applicable approved standard. All materials and devices used in the construction of a private sewage system or parts thereof shall be marked and identified in a manner satisfactory to the department.

(c) *Conformance.* Standards listed or referred to in this section cover materials which shall conform to the requirements of this chapter when used in accordance with the limitations imposed in this chapter. Designs and materials for special conditions or materials not provided for herein may be used only after the department has been satisfied as to their adequacy and granted approval.

Note: Chapter Comm 84 contains accepted and approved plumbing materials and the applicable standards.

(d) *Alterations.* In existing buildings or premises in which plumbing installations are to be altered, repaired or renovated, the department has discretionary powers to permit deviation from the provisions of this chapter provided that such a proposal to deviate is first submitted to the department for proper determination and approval.

(e) *Tests.* The department may require tests to be made or repeated, if at any time, there is reason to believe that any material or device no longer conforms to the requirements on which its approval was based.

(2) **MATERIAL STANDARDS.** Each material listed in Table 32 of s. Comm 82.19, shall conform to at least one of the standards opposite it. Products conforming to one or more of the specifications listed shall be considered acceptable subject to limitations specified. See s. Comm 83.02 (63) for a list of abbreviations. For materials not listed, consult the department.

(3) **PRECAST CONCRETE AND SITE CONSTRUCTED TANKS.** (a) Precast concrete tanks shall have a minimum wall thickness of 2 inches.

(b) *Materials.* The concrete used in constructing a precast or site-constructed tank shall be a mix to withstand a compressive load at least 3,000 pounds per square inch. All concrete tanks shall be designed to withstand the pressures to which they are subjected.

(c) *Joints.* The floor and sidewalls of a site-constructed concrete tank shall be monolithic except a construction joint will be permitted in the lower 12 inches of the sidewall of the tank. The

construction joint shall have a keyway in the lower section of the joint. The width of the keyway shall be approximately 30% of the thickness of the sidewall with a depth equal to the width. A continuous water stop or baffle at least 6 inches in width shall be set vertically in the joint, embedded 1/2 its width in the concrete below the joint with the remaining width in the concrete above the joint. The water stop or baffle shall be copper, neoprene, rubber or polyvinylchloride designed for this specific purpose. Joints between the concrete septic tank and its cover and between the septic tank cover and manhole riser shall be tongue and groove or shiplap type and sealed watertight using neat cement, mortar or bituminous compound.

(4) **STEEL SEPTIC TANKS.** For general tank design see s. Comm 83.15. Steel tanks shall be fabricated of new, hot rolled commercial steel. The tanks including cover with rim, inlet and outlet collars and manhole extension collars shall be fabricated with welded joints in such a manner as to provide structural stability and water tightness. Steel tanks shall be coated, inside and outside in compliance with U.L. Standard 70 Bituminous Coated Metal Septic Tanks. Any damage to the bituminous coating shall be repaired by recoating. The gauge of the steel shall be as follows:

SEPTIC TANK CAPACITY

Tank Design			
Vertical Cylindrical			
500 thru 1,000 gallons ...	Bottom and sidewalls	14 ga	None
.....	Cover	12 ga	
.....	Baffles	12 ga	
1,001 thru 1,250 gallons ..	Complete tank	10 ga	None
1,251 thru 1,500 gallons ..	Complete tank	7 ga	None
Horizontal Cylindrical			
500 thru 1,000 gallons ...	Complete tank	13 ga	54" dia
1,001 thru 1,500 gallons ..	Complete tank	12 ga	64" dia
1,501 thru 2,500 gallons ..	Complete tank	10 ga	76" dia
2,501 thru 9,000 gallons ..	Complete tank	7 ga	76" dia
9,001 thru 12,000 gallons .	Complete tank	1/4" plate	None
12,001 or more gallons ..	Complete tank	5/16"	None plate

(5) **FIBERGLASS SEPTIC TANKS.** (a) *General.* The following paragraphs apply to septic tanks made of glass-fiber reinforced polyester and intended for use in nonindustrial private sewage systems. For general septic tank design see s. Comm 83.15. Unless otherwise indicated, the plastic terminology used in this section is in accordance with the definitions given in ASTM Standard D 883.

(b) *Materials.* Septic tanks, covers, baffles, flanges, manholes, etc., shall be made from polyester resins with glass-fiber reinforcement and meet the general design criteria as prescribed in s. Comm 83.15 (1).

(c) *Resin.* The resin shall be a commercial grade of polyester resin and shall be evaluated as a laminate by tests conducted in accordance with ASTM Standard C 581. Unless otherwise approved by the department the same resin shall be used throughout the laminate.

(d) *Reinforcing material.* The reinforcing material shall be of a suitable commercial grade of glass-fiber (E Glass) treated with a coupling agent, approved by the glass-fiber manufacturer, that will provide a compatible bond between the resin and the glass. Glass-fiber surfacing materials, if used, shall be of a chemical-resistant glass (C glass) bonded with a suitable binder.

(e) *Fillers and pigments.* The resins used shall not contain fillers except as required for viscosity control. Up to 5% by weight of the total resin content of thixotropic agent that will not interfere with visual inspection may be added to the resin for viscosity control. Resins may contain pigments and dyes recognizing that such additions may interfere with visual inspection of laminate quality.

(f) *Laminate.* The laminate shall consist of the following: Primary chemical resistant surface; internal anti-wicking barrier; additional structural reinforcing section if required to meet the properties described in par. (h) and the following table; and exterior surface. (See following sketch.)

- 1) Primary Chemical-Resistant Surface
- 2) Internal Anti-Wicking Barrier

					To Desired				
1)	2)	2)	3)	3)	3)	3)	3)	3)	4)
					Thickness				
					For				
					Strength				

- 3) Additional Structural Reinforcing Section
- 4) Exterior Surface

(g) *Primary chemical resistant surface.* This surface shall be between 0.005 and 0.012 inch thick. It shall be a reinforced resin-rich surface. It shall be free from cracks and crazing and have a smooth finish.

(j) *Exterior surface.* This surface shall consist of a chopped strand glass over which shall be applied a resin-rich coating. This resin-rich surface layer shall contain less than 20% of reinforcing material.

(h) *Internal anti-wicking barrier.* Not less than 0.100 inch of chemical resistant laminate next to the inner surface shall be reinforced with not less than 20% or more than 30% by weight of mat or chopped strand.

(k) *Cut edges.* All cut edges shall be coated with resin so that no glass fibers are exposed and all voids are filled. Structural elements having edges exposed to the chemical environment shall be made with chopped strand glass reinforcement only.

(i) *Additional structural reinforcing sections.* This layer or body or the laminate shall be of chemically resistant construction suitable for the intended use and providing the additional strength necessary to meet the tensile and flexural requirements. When separate layers such as mat, cloth or woven roving are used, all layers shall be lapped at least one inch. Laps shall be staggered as much as possible. If woven roving or cloth is used, layers of chopped strand glass shall be placed as alternate layers.

(l) *Wall thickness.* The minimum wall thickness shall be as recommended by the manufacturer but in no case shall it be less than 3/16 inch regardless of operating conditions. Isolated small areas may be as thin as 80% of the specified minimum wall thickness.

(m) *Mechanical properties.* To establish proper wall thickness and other design characteristics, the minimum physical properties for any laminate shall be as shown in the following table and par. (n) below.

REQUIREMENTS FOR PROPERTIES OF NEWLY FABRICATED REINFORCED POLYESTER LAMINATES

Property at 73.4°F. in psi (MPa)*	Thickness in inches				Test Method
	3/16	1/4	5/16	3/8 & up	
Ultimate tensile strength, min.	9,000 (62)	12,000 (83)	13,500 (93)	15,000 (103)	ASTM D 638
Flexural strength, min.	16,000 (110)	19,000 (131)	20,000 (137)	22,000 (152)	ASTM D 790
Flexural modulus of elasticity (tangent), min.	700,000 (4823)	800,000 (5512)	900,000 (6201)	1,000,000 (6895)	ASTM D 790

*(MPa)=mega pascals

(n) *Surface hardness.* The laminate shall have a Barcol hardness of at least 90% of the manufacturer's minimum specified hardness for the cured resins when tested in accordance with ASTM D 2583. This requirement applies to both interior and exterior surfaces.

wise specified, ASTM D 2563 visual acceptance level 3 shall be the minimum standard for acceptance.

(o) *Appearance.* The finished laminate shall be as free as commercially practicable from visual defects such as foreign inclusions, dry spots, air bubbles, pinholes, pimples and delamination. The inner surface shall be free from cracks and crazing and have a smooth finish and an average of not more than 2 pits per square foot providing the pits are less than 1/8 inch diameter and not more than 1/32 inch deep and are covered with sufficient resin to avoid exposure of inner surface fabric. Some waviness is permissible provided the surface is smooth and free from pits. Unless other-

(p) *Tank design.* All tanks shall meet the general design criteria as outlined in s. Comm 83.15 (1) and (2). Horizontal cylindrical tanks standard end enclosed shall be convex heads with a maximum radius of curvature equal to the tank diameter. Rectangular tanks shall have external ribs to prevent sidewall deflection exceeding 1/2% of span at any location when tested by filling with water.

(q) *Shell joints.* Where tanks are manufactured in sections and joined by use of a laminate bond, the joint shall be glass-fiber reinforced resin at least the thickness of the heaviest section being joined. The reinforcement shall extend on each side of the joint a

sufficient distance to make the joint at least as strong as the tank wall, and shall be not less than the minimum joint widths specified in the following table. The reinforcement shall be applied both inside and out, with the inner reinforcement considered as a corrosion resistant barrier only and not structural material.

MINIMUM TOTAL WIDTHS OF OVERLAYS FOR REINFORCED-POLYESTER TANK SHELL JOINTS

Tank wall thickness in inches	3/16	1/4	5/16	3/8	7/16	1/2	9/16	5/8	11/16	3/4
Minimum outside overlay width in inches	4	4	5	6	7	8	9	10	11	12
Minimum inside overlay width in inches	4	4	5	5	6	6	6	6	6	6

(r) *Resistance to static load.* There shall be not more than 0.25% difference in dimensions before and after the tanks are statically loaded. For the static load test bed an empty tank in dry sand to a depth not exceeding 4 inches and oriented as in service. Load top segment of empty tank with evenly distributed load to a total weight in pounds equal to:

$$L = 140 \times A_1 \times b$$

where L = total load
 A₁ = horizontal cross-sectional area of tank
 b = depth of overburden expected

Rotate tank through 90° on its major axis. Bed tank in dry sand to a depth not exceeding 4 inches. Load sides of empty tank with evenly distributed load to total weight in pounds equal to:

$$L = 70 \times A_2 \times b$$

where L = total load
 A₂ = vertical cross-sectional area of tank
 b = depth of overburden expected

(s) *Siphoning or pumping.* There shall be no permanent deflection or change in length of any internal or external component of the tank during the pumping or siphoning when the tank is filled to its working level. There shall be no signs of leaking, weeping or other failure.

(t) *Weight.* No tank shall differ in gross weight by more than +10 or -5% from the weight of tanks that have been subjected to the tests for siphoning and static pressure.

(u) *Tests.* Tensile strength test shall be in accordance with ASTM D 638, except that the specimens shall be the actual thickness of the fabricated article and the width of the reduced section shall be one inch. Other dimensions of specimens shall be as designated by the ASTM standard for type one specimens for materials over 1/2 inch to one inch inclusive. Specimens shall not be machined on the surface. Test 5 specimens at 0.20 to 0.25 inch/minute crosshead speed, and average the results. Flexural strength shall be determined in accordance with Procedure A and Table 1 of ASTM D 790, except that the specimens shall be actual thickness of the fabricated article and the width shall be one inch. Other dimensions of specimens shall be as designated by the ASTM standard. Specimens shall not be machined on the surface. Test 5 specimens, with the resin-rich side in compression. Determine the tangent modulus of elasticity in flexure by ASTM D 790.

(6) **ALTERNATE AND EXPERIMENTAL MATERIALS.** (a) *Intent.* The provisions of this chapter are not intended to prevent the use of any alternate material provided the material has first been approved and its use authorized by the department.

(b) *Approval.* The department may approve an alternate or experimental material in accord with s. 145.02 (2) (b), Stats., provided the proposed alternate or the experimental concepts are satisfactory and comply with the intent of this chapter.

(c) *Evidence or proof.* The department shall require that sufficient evidence or proof be submitted to substantiate any claims that may be made regarding the sufficiency of any proposed material.

(d) *Tests and standards.* Tests shall be made in accord with approved standards but in the absence of such standards, the department shall specify the test procedure.

(e) *Repeating tests.* The department may require tests to be made or repeated if at any time there is reason to believe that any material no longer conforms to the requirements on which its approval is based.

History: Cr. Register, December, 1980, No. 300, eff. 1-1-81; renun. from H 63.20, Register, June, 1983, No. 330, eff. 7-1-83; r. and recr. (1) (c), Register, February, 1985, No. 350, eff. 3-1-85.

Comm 83.21 Building sewers and drains. (1) **GENERAL.** Building sewers which terminate in a septic tank shall meet the same general criteria as listed in s. Comm 82.30, except where specified in this section. All sanitary or special type drainage systems shall be connected by means of independent connections with a public sewer, approved private interceptor main sewer or private sewage system.

(2) **COVER.** Building sewers which terminate in a septic tank shall not be less than 18 inches from the top of the pipe to finished grade.

(3) **MATERIALS.** All building sewers which terminate in a septic tank shall be constructed of cast iron, vitrified clay, concrete, asbestos cement, plastic or bituminous fiber pipe or other materials approved by the department. The pipe from the septic tank to the soil absorption area shall be constructed of solid wall pipe approved by the department as specified in ch. Comm 84.

History: Cr. Register, December, 1980, No. 300, eff. 1-1-81; renun. from H 63.21, Register, June, 1983, No. 330, eff. 7-1-83; am. (1) and (3), Register, February, 1985, No. 350, eff. 3-1-85.

Comm 83.23 Mound systems. (1) **SOIL AND SITE REQUIREMENTS.** (a) *General.* The installation of a mound in a floodplain or filled area is prohibited. Removal of fill material may not make a site suitable. A mound shall not be installed in a compacted area. A mound shall not be installed over a failing private sewage system.

(b) *Soil boring and percolation tests.* A minimum of 3 soil borings shall be conducted in accord with s. Comm 83.09 to determine depth to seasonal or permanent soil saturation or bedrock. Identification of a replacement system area is not required.

1. 'Slowly permeable soils.' Mound sizing shall be based on soil evaluation or percolation test results. Where sizing is based on soil evaluation, the most limiting condition from Table 0 that occurs within the top 12 inches of the natural soil shall be used to determine the soil loading factor. Where sizing is based on percolation test results, percolation tests shall be conducted in the most restrictive soil horizon within 24 inches measured vertically from the top of existing grade. A mound system is suitable for the site if the percolation rate is greater than 60 minutes per inch and less than or equal to 120 minutes per inch. A site with a percolation rate of greater than 60 minutes per inch and less than or equal to 120 minutes per inch or a maximum wastewater infiltration rate of 0.3 or less shall be designated as a site with slowly permeable soils.

Note: As a result of a court action, s. Comm 83.23 (1) (b) 1. as printed was prevented from taking effect on June 1, 1996. Prior to June 1, 1996, s. Comm 83.23 (1) (b) 1. read as follows:

ILHR 83.23 (1) (b) 1. 'Slowly permeable soils'. Mound sizing shall be based on soil evaluation or percolation test results. Where sizing is based on soil evaluation, the most limiting condition from Table 0 that occurs within the top 12 inches of the natural soil shall be used to determine the soil loading factor. Where sizing is based on percolation test results, percolation tests shall be conducted in the most restrictive soil horizon within 24 inches measured vertically from the top of existing grade. A

mound system is suitable for the site if the percolation rate is greater than 60 minutes per inch and less than or equal to 120 minutes per inch.

2. 'Shallow permeable soils over creviced bedrock.' Mound sizing shall be based on soil evaluation or percolation test results. Where sizing is based on soil evaluation, the most limiting condition from Table 0 that occurs within the top 12 inches of the natural soil shall be used to determine the soil loading factor. Where sizing is based on percolation testing, percolation tests shall be conducted in the most restrictive soil horizon within 18 inches measured vertically from the top of existing grade. A mound system is suitable for this site condition if the percolation rate is greater than 3 minutes per inch and less than or equal to 60 minutes per inch.

3. 'Permeable soils with high groundwater.' Mound sizing shall be based on soil evaluation or percolation test results. Where sizing is based on soil evaluation, the most limiting condition from Table 0 that occurs within the top 12 inches of the natural soil shall be used to determine the soil loading factor. Where sizing is based on percolation testing, percolation tests shall be conducted in the most restrictive soil horizon within 24 inches measured vertically from the top of existing grade. A mound system is suitable for this site condition if the percolation rate is greater than 0 minutes per inch and less than or equal to 60 minutes per inch.

(c) *Depth to pervious rock.* A mound system shall be allowed where at least 24 inches of natural soil exists above creviced or porous bedrock.

Note: As a result of a court action, s. Comm 83.23 (1) (c) as printed was prevented from taking effect on June 1, 1996. Prior to June 1, 1996, s. Comm 83.23 (1) (c) read as follows:

(c) *Depth to pervious rock.* There shall be at least 24 inches of unsaturated natural soil over creviced or porous bedrock.

(d) *Depth to groundwater.* A mound system shall be allowed where at least 8 inches of unsaturated natural soil exists above estimated high groundwater as indicated by soil morphological conditions and provided:

1. The soils are not mottled or gleyed in the "E" or "B" horizon which is within 4 inches of the bottom of the "A" horizon; and

2. The cumulative depth of sand, as specified in sub. (2) (d) 1. a., and depth of unsaturated natural soil provides at least 3 feet of vertical separation to high groundwater.

Note: As a result of a court action, s. Comm 83.23 (1) (d) as printed was prevented from taking effect on June 1, 1996. Prior to June 1, 1996, s. Comm 83.23 (1) (d) read as follows:

(d) *Depth to groundwater.* 1. Except as provided in subd. 2., a mound system shall be allowed where at least 24 inches of unsaturated natural soil exists above estimated high groundwater as indicated by soil morphological conditions.

2. A mound system replacing an existing private sewage system shall be allowed where less than 24 inches of unsaturated natural soil exists above estimated high groundwater provided that:

a. The soils are not mottled or gleyed in the "E" or "B" horizon which is within 4 inches of the bottom of the "A" horizon; and

b. The cumulative depth of sandfill, as specified in sub. (2) (d) 1. a., and depth of suitable soil provides at least 3 feet of vertical separation to high groundwater.

TABLE 14

**MINIMUM SAND FILL DEPTH (D) FOR MOUNDS
ON SITES HAVING AT LEAST 24 INCHES
ABOVE A SOIL OR SITE FACTOR**

Soil or Site Factor ^a	Minimum Sand Fill Depth (D) (Inches)
Slowly Permeable Soils ^b	12
Estimated High Groundwater	12
Bedrock	
creviced	24 ^c
poorly cemented sandstone	12

^aSoil type as identified in s. Comm 83.23 (1).

^bRefer to s. Comm 83.23 (1) (b) 1. for soils having loading rates 0.3 or less.

^cMinimum depth may be reduced to 18 inches on slopes 10% or greater.

Note: As a result of a court action, Table 14 as printed was prevented from taking effect on June 1, 1996. Prior to June 1, 1996, Table 14 read as follows:

**TABLE 14
MINIMUM SAND FILL DEPTH (D) FOR MOUNDS
ON SITES HAVING AT LEAST 24 INCHES
ABOVE A SOIL OR SITE FACTOR**

Soil or Site Factor ^a	Minimum Sand Fill Depth (D) (Inches)
Slowly Permeable Soils ^b	12
Estimated High Groundwater	12
Bedrock	
creviced	24 ^c
poorly cemented sandstone	12
Strata having 50% or more rock fragments by volume	12

^aSoil type as identified in s. Comm 83.23 (1).

^bRefer to s. Comm 83.23 (1) (b) 1. for soils having loading rates 0.3 or less.

^cMinimum depth may be reduced to 18 inches on slopes 10% or greater.

(e) *Slopes.* 1. A mound system may not be installed on a site where the slope is greater than 20%.

2. A mound system shall be installed such that the longest dimension of the mound does not exceed one percent across the slope of the site.

Note: As a result of a court action, s. Comm 83.23 (1) (e) as printed was prevented from taking effect on June 1, 1996. Prior to June 1, 1996, s. Comm 83.23 (1) (e) read as follows:

(e) *Slopes.* 1. A mound may not be installed on a slope which is greater than 12%, except as permitted under subd. 2.

2. A mound replacing an existing private sewage system may not be installed on a slope which is greater than 20%.

(f) *Depth to rock strata or 50% by volume rock fragments.* There shall be at least 60 inches of soil over uncreviced, impermeable bedrock. If the soil contains 50% coarse fragments by volume in the upper 24 inches, a mound cannot be installed unless there is at least 24 inches of permeable, unsaturated soil that has less than 50% coarse fragments beneath this layer.

(2) **MOUND DESIGN AND DIMENSIONS.** (a) *Design criteria.* 1. A mound system to be installed on a site where there is at least 24 inches of unsaturated natural soil above estimated high groundwater, bedrock or slowly permeable soils shall be designed using the specifications of pars. (b) to (h).

2. A mound system to be installed on a site where there is less than 24 inches of unsaturated natural soil above estimated high groundwater or slowly permeable soils shall be designed using the specifications of pars. (b) to (h) with the depth of sand fill (D) increased in accordance with par. (d).

Note: The dimensions and corresponding letter designations referenced in this section are shown in Figures 1 through 5.

Note: As a result of a court action, s. Comm 83.23 (2) (a) 2. as printed was prevented from taking effect on June 1, 1996. Prior to June 1, 1996, s. Comm 83.23 (2) (a) 2. read as follows:

2. A mound system to replace an existing private sewage system, and to be installed on a site where there is less than 24 inches of unsaturated natural soil above estimated high groundwater, bedrock or slowly permeable soils shall be designed using the specifications of pars. (b) to (h) with depth of sand fill (D) increased according to the formula in par. (e).

(b) *Design of the absorption area.* The minimum size of the absorption area for a mound system shall be determined by dividing the total daily wastewater flow by the infiltrative capacity of the sand fill.

1. The infiltration rate for the sand fill may not exceed 1.2 gal./day/ft.²

2. The daily wastewater flow shall be determined in accordance with s. Comm 83.12.

(c) *System configuration.* 1. 'Trenches.' a. For slowly permeable soils with or without high groundwater, the effluent shall be distributed in the mound through a trench system.

b. Trenches shall be one to 5 feet in width.

c. The lineal feet of trench required shall be calculated by dividing the required absorption area by the trench width (A).

d. Trench excavations for mound systems shall be placed at least 6 feet apart.

2. 'Beds.' The bed width (A) shall be determined by dividing the absorption area required by (B).

Note: As a result of a court action, s. Comm 83.23 (2) (c) as printed was prevented from taking effect on June 1, 1996. Prior to June 1, 1996, s. Comm 83.23 (2) (c) read as follows:

(c) System configuration. 1. 'Trenches.' a. For slowly permeable soils with or without high groundwater, the effluent shall be distributed in the mound through a trench system. Trench length should be selected by determining the longest dimension that is perpendicular to any slope on the site. Trench width and trench spacing is dependent on specific site conditions.

b. Trenches shall be 2 to 4 feet in width.

c. The lineal feet of trench required shall be calculated by dividing the required absorption area by the trench width (A). Trench length (B) shall not be more than 100 feet. Where more than one trench is required, the trenches should be of equal length. A mound should not have more than 3 trenches.

d. Trench spacing (C) shall be determined by comparing the estimated wastewater flow, the infiltrative capacity of the natural soil and the trench length (B). Trench spacing (C) shall be calculated as:

$$\text{Trench spacing (C)} = \frac{\text{Estimated wastewater flow} + (0.24 \text{ gal/ft.}^2/\text{day}) \times \text{trench length (B)}}{\text{Number of trenches}}$$

The calculated trench spacing (C) shall be measured from center to center of the trenches.

Note: For facilities with more than 1,500 gallons per day that must use a trench system, the department should be contacted prior to system design.

2. 'Beds.' A long, narrow bed design should be used for permeable soils with high water tables. The bed can be square or rectangular for shallow permeable soils over bedrock. The bed length (B) should be set after determining the longest dimension that is available and that is perpendicular to any slope on the site. The bed width (A) shall be determined by dividing the absorption area required by (B).

(d) Mound dimensions. 1. 'Mound height.' On sites the mound height shall be calculated using the following equation where: sand fill depth (D), the downslope fill depth (E), the bed or trench depth (F), and the cap and topsoil depth (H).

$$\text{Mound height} = \frac{(D + E)}{2} + F + H$$

a. For sites having at least 24 inches above estimated high groundwater, bedrock, or slowly permeable soils, the minimum sand fill depth (D) shall be 12 inches, unless otherwise specified in Table 14. For mounds on sites having less than 24 inches above estimated high groundwater or slowly permeable soils, the sand fill depth (D) shall be based on the following calculation:

Where D = 12 inches + (24 inches - depth in inches to soil or site factor)

Note: As a result of a court action, s. Comm 83.23 (2) (d) 1. a. as printed was prevented from taking effect on June 1, 1996. Prior to June 1, 1996, s. Comm 83.23 (2) (d) 1. a. read as follows:

a. For sites having at least 24 inches above estimated high groundwater, bedrock, or slowly permeable soils, the minimum sand fill depth (D) shall be 12 inches, unless otherwise specified in Table 14. For mounds replacing existing private sewage systems on sites having less than 24 inches above estimated high groundwater, bedrock, or slowly permeable soils, the sand fill depth (D) shall be based on the following calculation:

Where D = 12 inches + (24 inches - depth in inches to soil or site factor)

am. On a sloping site, the sand fill depth (E) placed at the downslope edge of the bed or trench shall be increased so that the bottom of the bed or trench is level. The downslope sand fill depth (E) shall be increased according to one of the following calculations:

For beds: E = D + [(slope percentage)(A)].

For trenches: E = D + [(slope percentage)(C+A)].

b. The bed or trench depth (F) shall be at least .75 feet. At least 6 inches of aggregate shall be placed under the distribution pipes and at least 2 inches of aggregate shall be placed over the top of the distribution pipes.

c. The cap and top soil depth (H) at the center of the mound shall be at least 1.5 feet which includes 1 foot of subsoil and 0.5 feet of top soil. At the outer edges of the mound the minimum cap and top soil depth (G) shall be 1 foot which includes 0.5 feet of subsoil and 0.5 feet of top soil. The soil used for the cap can be top soil or finer textured subsoil.

2. 'Mound length.' The total mound length (L) is equal to the bed or trench length plus the end slopes (K).

$$\text{a. The end slope (K)} = \frac{\text{mound depth}}{3 : 1 \text{ slope}} = \left[(D + \frac{E}{2}) + F + H \right] \times 3.$$

$$\text{b. The total mound length (L)} = \text{(bed or trench length, B)} + 2 \text{ (end slope, K).}$$

3. 'Mound width.' The total width (W) of a mound with a bed design shall be equal to the upslope width (J), the bed width (A) and the downslope width (I). When a trench design is used, the total width (W) shall be equal to the upslope width (J), the trench width or widths (A), the trench spacing (C) and the downslope width (I). On sloping sites the downslope width (I) shall be greater than the upslope width (J). On level sites the upslope width and the downslope width shall be the same.

$$\text{a. Upslope width (J)} = \frac{\text{mound depth at upslope edge}}{3 : 1 \text{ slope}} \times \text{slope correction factor from Table 15} =$$

$$(D + F + G) \times 3 \times \text{correction factor}$$

$$\text{b. Downslope width (I)} = \frac{\text{mound depth at downslope edge}}{3 : 1 \text{ slope}} \times \text{slope correction factor from Table 15} =$$

$$(E + F + G) \times 3 \times \text{correction factor}$$

c. The mound width (W) for a bed system = upslope width (J) + bed width (A) + downslope width (I).

$$\text{The mound width (W) for a trench system} = \frac{\text{upslope width (J)} + \frac{\text{trench width (A)}}{2} + \frac{(\text{number trenches}-1) \times (\text{trench spacing (C)})}{2} + \frac{\text{trench width (A)}}{2} + \text{downslope width (I)}}{2}$$

TABLE 15
DOWNSLOPE AND UPSLOPE WIDTH
CORRECTIONS FOR MOUNDS ON SLOPING SITES

Slope %	Downslope Correction Factor	Upslope Correction Factor
0	1.00	1.00
1	1.03	0.97
2	1.06	0.94
3	1.10	0.915
4	1.14	0.89
5	1.18	0.875
6	1.22	0.85
7	1.27	0.83
8	1.32	0.80
9	1.38	0.785
10	1.44	0.77
11	1.51	0.75
12	1.57	0.73
13	1.64	0.72
14	1.72	0.705
15	1.82	0.69
16	1.92	0.675
17	2.04	0.66
18	2.17	0.65
19	2.33	0.64
20	2.50	0.625

Note: As a result of a court action, Table 15 as printed was prevented from taking effect on June 1, 1996. Prior to June 1, 1996, Table 15 read as follows:

TABLE 15
DOWNSLOPE AND UPSLOPE WIDTH
CORRECTIONS FOR MOUNDS ON SLOPING SITES

Slope %	Downslope Correction Factor	Upslope Correction Factor
0	1.00	1.00
1	1.03	0.97
2	1.06	0.94
3	1.10	0.915
4	1.14	0.89
5	1.18	0.875
6	1.22	0.86
7	1.27	0.83
8	1.32	0.80
9	1.38	0.785
10	1.44	0.77
11	1.51	0.75
12	1.57	0.73

(e) *Basal area.* 1. The minimum basal area shall be calculated using the infiltrative capacity of the natural soil and the total daily wastewater flow.

a. When using percolation test results, the minimum basal area shall be determined by dividing the total daily wastewater flow by the infiltrative capacity of the soil as specified in Table 4 or 4a.

b. When using soil evaluation, the minimum basal area shall be determined by dividing the total daily wastewater flow by the loading rate of the soil as specified in Table 0.

2. 'Basal area available, bed.' On sloping sites the basal area shall be that area under the bed and downslope of the bed. On level sites the basal area shall be the entire area under the mound excluding the end slope areas. The appropriate equation from one of the following shall be used to determine the available basal area.

$$\text{Bed length (B)} \times \text{bed width (A)} + \text{downslope width (I)} = \text{basal area available for sloping site}$$

$$\text{Bed length (B)} \times \text{total mound width (W)} = \text{basal area available for level sites}$$

3. 'Basal area available, trench.' On sloping sites the basal area shall be that area under and downslope of the trenches. On level sites the basal area shall be the total area under the mound excluding the end slope areas. The appropriate equation from one of the following shall be used to determine the available basal area.

$$\text{Trench length (B)} \times \left[\text{mound width (W)} - \text{upslope width (J)} + \frac{\text{trench width (A)}}{2} \right] = \text{basal area available for sloping sites}$$

$$\text{Trench length (B)} \times \text{total mound width (W)} = \text{basal area available for level sites}$$

4. 'Adequacy of basal area.' If the basal area available is not equal to or greater than the basal area required, the downslope width (I) on a sloping site shall be increased or the up and downslope widths (J) and (I) on a level site shall be increased until sufficient area is available.

(f) *Distribution system.* The distribution system for mounds for daily flows less than 600 gallons per day may be sized in accord with the applicable criteria in sub. (3) or with s. Comm 83.14 (3). For all other buildings, the distribution system shall be designed in accord with s. Comm 83.14 (3).

(g) *Pump selection.* Pump selection shall be based upon the criteria specified in s. Comm 83.14 (5).

Note: For pump and alarm controls refer to s. Comm 83.14 (5).

(h) *Dose volume.* The dose volume shall be calculated either:

1. According to s. Comm 83.14 (6);
2. Using the design flow from Table 12; or
3. Using 150 gallons per bedroom for one- and 2-family residences.

(3) *CONSTRUCTION TECHNIQUES.* Construction shall not commence if the soil is too wet. The soil is too wet for construction if at any level to a depth of 8 inches a soil wire can be formed by rolling the soil between the hands. Installation of mound systems when the soil on the site is frozen is prohibited for new construction.

(a) *Site preparation.* 1. 'Excess vegetation.' Excess vegetation shall be cut and removed from the area of the mound. Small trees shall be cut to grade surface leaving the stumps in place.

2. 'Force main.' The force main from the pumping chamber shall be installed before the mound site is plowed. The force main should be sloped uniformly towards the pumping chamber so that it drains after each dose.

3. 'Plowing.' The site shall be plowed with a mold board plow or chisel plow. The site shall be plowed to a depth of 7 to 8 inches with the plowing perpendicular to the slope. Rototillers shall not be used. The sand fill shall be placed immediately after plowing. After plowing, all foot and vehicular traffic shall be kept off the plowed area.

(b) *Sand fill material.* 1. 'Sand fill quality.' The sand fill to be used in the construction of a mound type private sewage system shall conform with fine aggregate specifications delineated in ASTM C33.

2. 'Placement of sand fill.' The sand fill shall be moved into place from the upslope and side edges of the plowed area. Vehicular traffic is prohibited in the area extending to 25 feet beyond the downslope edge of the mound. The sand fill shall be moved into place with a track-type tractor. A minimum of 6 inches of sand shall be kept beneath the tracks at all times.

3. 'Installation of the absorption area.' Form the bed or trenches within the sand fill. The bottom of the trenches or bed shall be level. The elevation of the bottom of the trenches or bed shall be checked at the upslope and downslope edges to make certain that the fill has been placed to the proper depth.

4. 'Placement of the aggregate.' A minimum of 6 inches of coarse aggregate ranging in size from 1/2 inch to 2 1/2 inches shall be placed in the bed or trench excavation. The top of the aggregate shall be level.

5. 'Distribution system.' Place the distribution system on the aggregate with the holes on the bottom of the distribution lines.

6. 'Cover.' The top of the bed or trenches shall be covered with a minimum of 2 inches of aggregate ranging in size from 1/2 inch to 2 1/2 inches. A minimum of 4 to 5 inches of uncompacted straw or marsh hay, or synthetic fabric approved by the department shall be placed over the aggregate. The cap and top soil cover shall be placed. The mound shall be seeded immediately and protected from erosion.

7. 'Maintenance.' Maintenance shall be performed in accord with s. Comm 83.16 (1). When the septic tank is pumped the pump chamber shall be inspected and shall be pumped to remove any solids if present. Excess traffic in the mound area shall be avoided.

History: Cr. Register, December, 1980, No. 300, eff. 1-1-81; renum. from H 63.23, Register, June, 1983, No. 330, eff. 7-1-83; am. (1) (b) 1., 2. and 3., Register, June, 1991, No. 426, eff. 7-1-91; r. and recr. (1) (a), (d), (e), (2) (a), (d) I. (intro.), a., (e) 1., (g) and (h), r. (2) (intro.), (3) and Tables 14 and 16, cr. (2) (d) 1. am. and Table 14, renum. (4) to be (3), Register, April, 1992, No. 436, eff. 5-1-92; correction in (2) (a) made under s. 13.93 (2m) (b) 7., Stats., Register, April, 1992, No. 436; am. (1) (a), (3) (b) 2. and Table 14, r. and recr. (2) (a), (b) and (3) (b) 1., r. Tables 17 to 28, Register, February, 1994, No. 458, eff. 3-1-94; am. (1) (b) 1., (2) (a) 2., (c) 1. a. to c., 2., (d) 1. a. and Table 14, r. and recr. (1) (c) to (e) and (2) (c) 1. d., Register, May, 1996, No. 485, eff. 6-1-96.

Figure 1

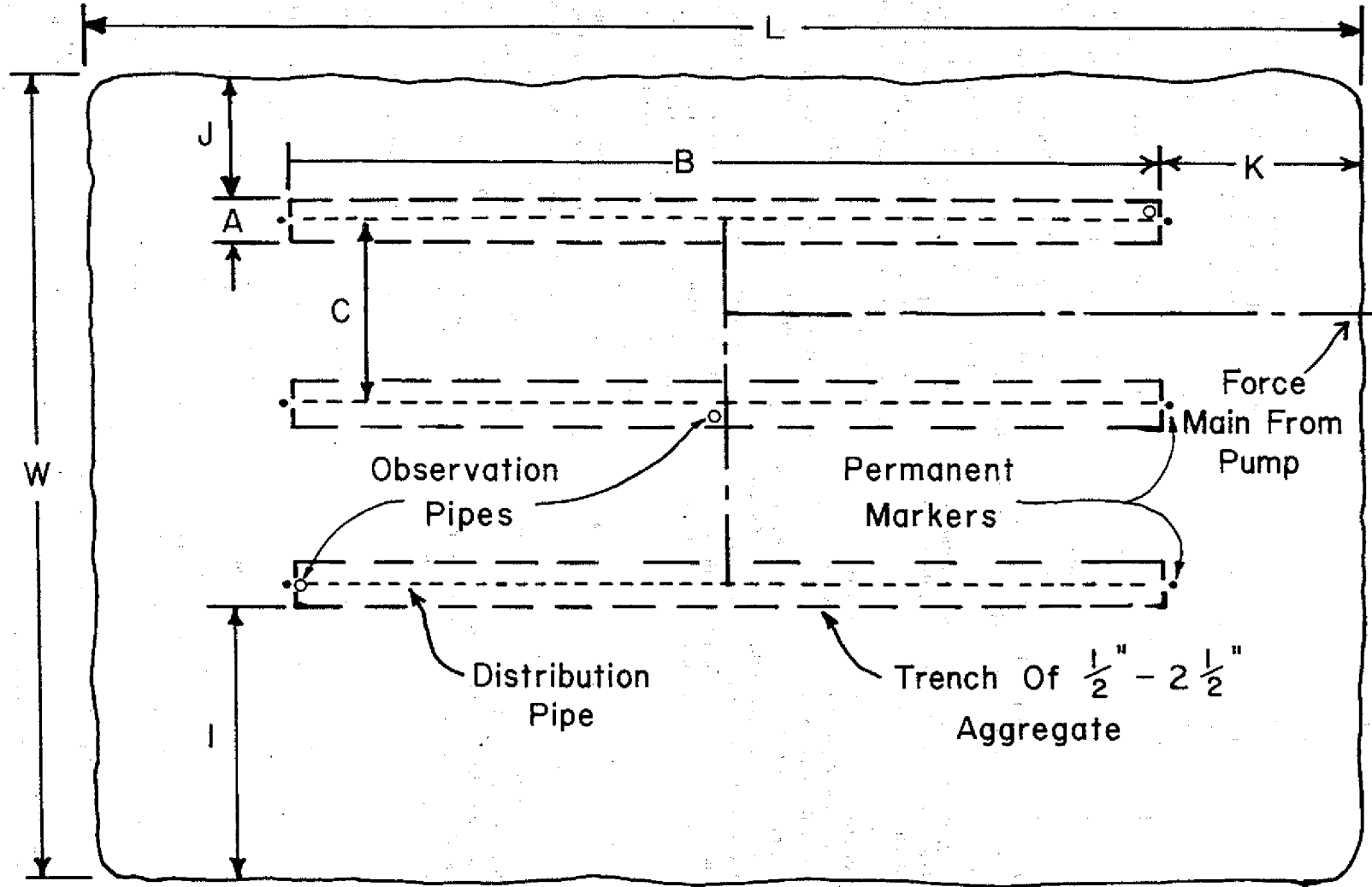

Mound Using 3 Trenches For Absorption Area

Figure 2

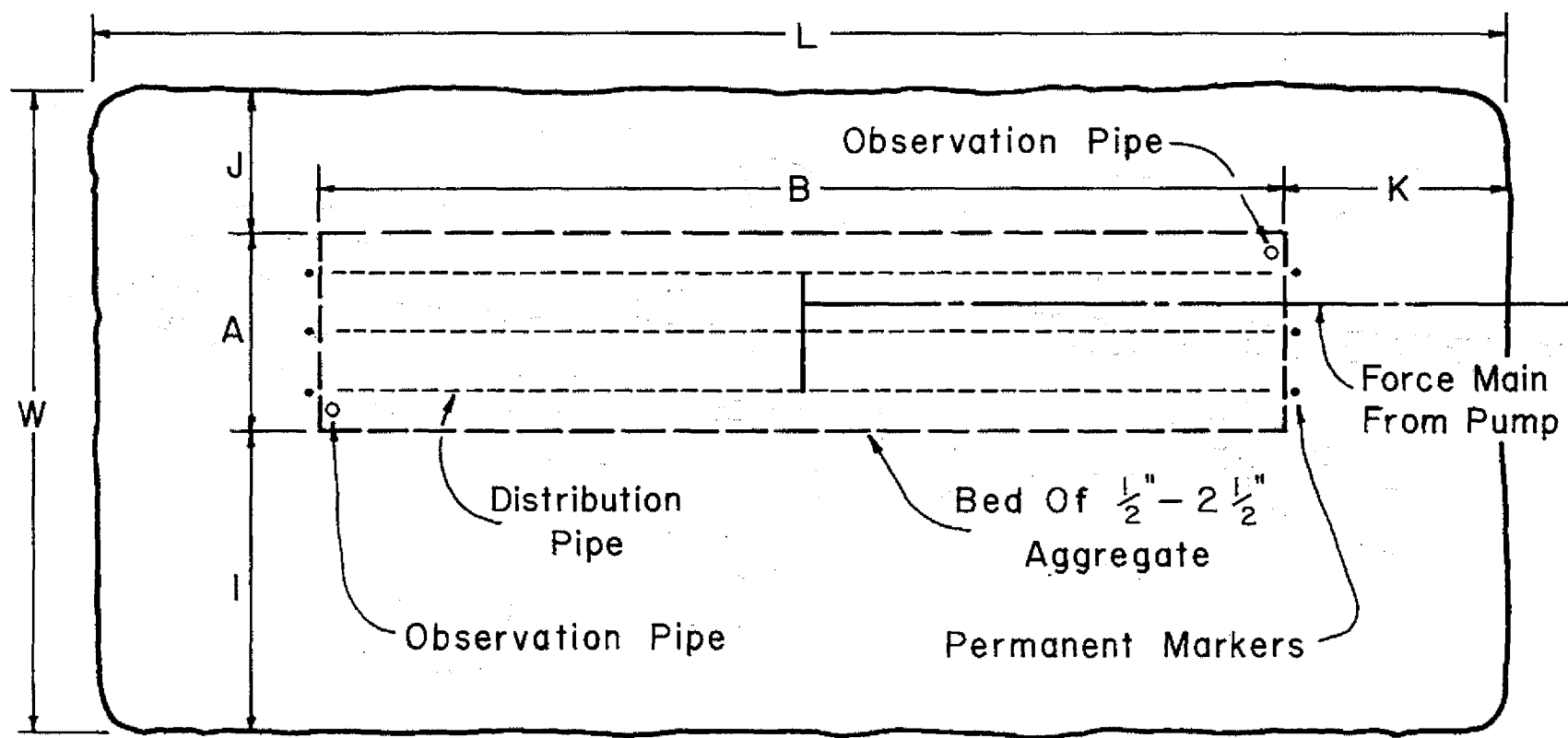

Plan View Of Mound Using A Bed For The Absorption Area

Figure 3

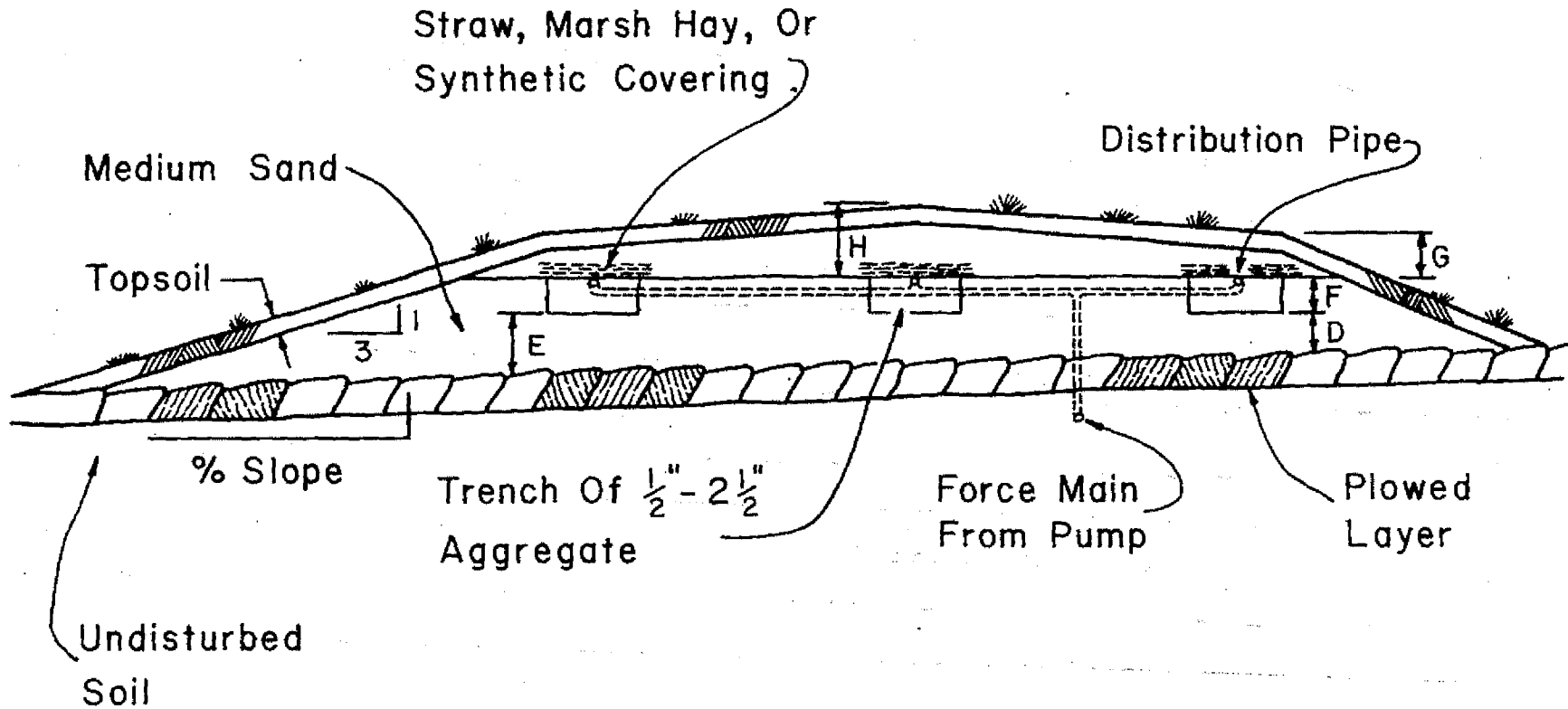

Cross Section Of A Mound System Using
3 Trenches For The Absorption Area

Figure 4

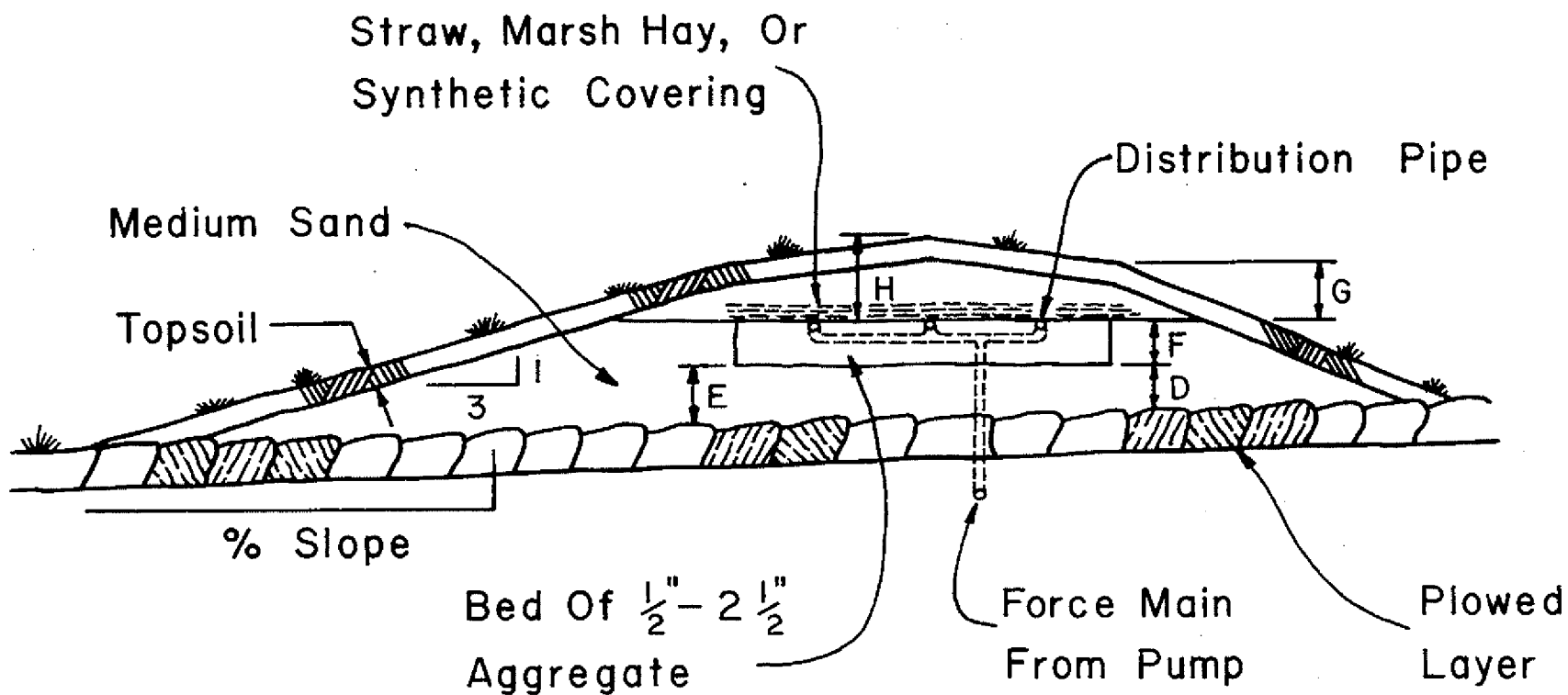

Cross Section Of A Mound System Using
A Bed For The Absorption Area

