

UDC Appendix Table of Contents

Chapter 20	
Sample Forms	70
Sanitary Permit Requirements	82
Chapter 21	
Fastener Schedule	83
Use of Span & Species Tables	85
Span & Species Tables	91
Handrail Diagrams	116
Erosion Control Procedures	117
Frost-Protected Shallow Footings	135
Chapter 22	
Energy Worksheet Example	137
Sample Energy Worksheet Form	143
Default Assembly R & U-Value Tables	151
Typical Thermal Properties of Building Materials	158
Slab-On-Grade Insulation Details	160
UDC Index	161

Wisconsin Division of Safety and Buildings Wisconsin Stats. 101.63, 101.73		WISCONSIN UNIFORM BUILDING PERMIT APPLICATION Instructions on back of yellow ply. The information you provide may be used by other government agency programs (Privacy Law, s. 15.04 (1)(m))			Application No. _____ Parcel No. _____																																
PERMIT REQUESTED		<input type="checkbox"/> Constr. <input type="checkbox"/> HVAC <input type="checkbox"/> Electric <input type="checkbox"/> Plumbing <input type="checkbox"/> Erosion Control Other: _____																																			
Owner's Name _____		Mailing Address _____			Tel. _____																																
Contractor's Name: <input type="checkbox"/> Con <input type="checkbox"/> Elec <input type="checkbox"/> HVAC <input type="checkbox"/> Plbg		Lic/Cert# _____	Mailing Address _____		Tel. _____ FAX _____																																
Contractor's Name: <input type="checkbox"/> Con <input type="checkbox"/> Elec <input type="checkbox"/> HVAC <input type="checkbox"/> Plbg		Lic/Cert# _____	Mailing Address _____		Tel. _____ FAX _____																																
Contractor's Name: <input type="checkbox"/> Con <input type="checkbox"/> Elec <input type="checkbox"/> HVAC <input type="checkbox"/> Plbg		Lic/Cert# _____	Mailing Address _____		Tel. _____ FAX _____																																
Contractor's Name: <input type="checkbox"/> Con <input type="checkbox"/> Elec <input type="checkbox"/> HVAC <input type="checkbox"/> Plbg		Lic/Cert# _____	Mailing Address _____		Tel. _____ FAX _____																																
PROJECT LOCATION		Lot area _____ Sq. ft.		of Section _____, T _____ N, R _____ E (or) W _____																																	
Building Address _____		Subdivision Name _____		Lot No. _____		Block No. _____																															
Zoning District(s) _____		Zoning Permit No. _____		Setbacks: Front _____ ft. Rear _____ ft. Left _____ ft. Right _____ ft.																																	
1. PROJECT <input type="checkbox"/> New <input type="checkbox"/> Repair <input type="checkbox"/> Alteration <input type="checkbox"/> Raze <input type="checkbox"/> Addition <input type="checkbox"/> Move <input type="checkbox"/> Other: _____		3. OCCUPANCY <input type="checkbox"/> Single Family <input type="checkbox"/> Two Family <input type="checkbox"/> Garage <input type="checkbox"/> Other: _____		6. ELECTRICAL Entrance Panel _____ Amps: _____ <input type="checkbox"/> Underground <input type="checkbox"/> Overhead 7. FOUNDATION <input type="checkbox"/> Concrete <input type="checkbox"/> Masonry <input type="checkbox"/> Treated Wood <input type="checkbox"/> Other: _____		9. HVAC EQUIPMENT <input type="checkbox"/> Forced Air Furnace <input type="checkbox"/> Radiant Baseb/ Panel <input type="checkbox"/> Heat Pump <input type="checkbox"/> Boiler <input type="checkbox"/> Central Air Cond. <input type="checkbox"/> Other: _____		12. ENERGY SOURCE <table style="width:100%; font-size: small;"> <tr> <td>Fuel</td> <td>Nat Gas</td> <td>LP</td> <td>Oil</td> <td>Elec</td> <td>Solid</td> <td>Solar</td> </tr> <tr> <td><input type="checkbox"/></td> <td><input type="checkbox"/></td> <td><input type="checkbox"/></td> <td><input type="checkbox"/></td> <td><input type="checkbox"/></td> <td><input type="checkbox"/></td> <td><input type="checkbox"/></td> </tr> <tr> <td>Space Htg</td> <td><input type="checkbox"/></td> <td><input type="checkbox"/></td> <td><input type="checkbox"/></td> <td><input type="checkbox"/></td> <td><input type="checkbox"/></td> <td><input type="checkbox"/></td> </tr> <tr> <td>Water Htg</td> <td><input type="checkbox"/></td> <td><input type="checkbox"/></td> <td><input type="checkbox"/></td> <td><input type="checkbox"/></td> <td><input type="checkbox"/></td> <td><input type="checkbox"/></td> </tr> </table> <input type="checkbox"/> Dwelling unit has 3 kilowatt or more electric space heating equip. Infiltration control option is <input type="checkbox"/> Sealing of all joints <input type="checkbox"/> Blower door test. <input type="checkbox"/> Exterior air infiltration barrier		Fuel	Nat Gas	LP	Oil	Elec	Solid	Solar	<input type="checkbox"/>	<input type="checkbox"/>	<input type="checkbox"/>	<input type="checkbox"/>	<input type="checkbox"/>	<input type="checkbox"/>	<input type="checkbox"/>	Space Htg	<input type="checkbox"/>	<input type="checkbox"/>	<input type="checkbox"/>	<input type="checkbox"/>	<input type="checkbox"/>	<input type="checkbox"/>	Water Htg	<input type="checkbox"/>	<input type="checkbox"/>	<input type="checkbox"/>	<input type="checkbox"/>	<input type="checkbox"/>	<input type="checkbox"/>
Fuel	Nat Gas	LP	Oil	Elec	Solid	Solar																															
<input type="checkbox"/>	<input type="checkbox"/>	<input type="checkbox"/>	<input type="checkbox"/>	<input type="checkbox"/>	<input type="checkbox"/>	<input type="checkbox"/>																															
Space Htg	<input type="checkbox"/>	<input type="checkbox"/>	<input type="checkbox"/>	<input type="checkbox"/>	<input type="checkbox"/>	<input type="checkbox"/>																															
Water Htg	<input type="checkbox"/>	<input type="checkbox"/>	<input type="checkbox"/>	<input type="checkbox"/>	<input type="checkbox"/>	<input type="checkbox"/>																															
2. AREA INVOLVED Unfin. _____ Sq Ft Bsmt _____ Sq Ft Living Area _____ Sq Ft Garage _____ Sq Ft Deck _____ Sq Ft		4. CONST. TYPE <input type="checkbox"/> Site-Built <input type="checkbox"/> Mfd: <input type="checkbox"/> UDC <input type="checkbox"/> HUD		5. STORIES <input type="checkbox"/> 1-Story <input type="checkbox"/> 2-Story <input type="checkbox"/> Other: _____ <input type="checkbox"/> Plus Basement		8. USE <input type="checkbox"/> Seasonal <input type="checkbox"/> Permanent <input type="checkbox"/> Other: _____		10. SEWER <input type="checkbox"/> Municipal <input type="checkbox"/> Septic Permit No.: _____		13. HEAT LOSS (Calculated) Envelope _____ BTU/HR Infiltration _____ BTU/HR																											
11. WATER <input type="checkbox"/> Municipal Utility <input type="checkbox"/> Private On-Site Well		14. EST. BUILDING COST \$ _____																																			
I agree to comply with all applicable codes, statutes and ordinances and with the conditions of this permit; understand that the issuance of the permit creates no legal liability, express or implied, on the state or municipality; and certify that all the above information is accurate. If I am an owner applying for an erosion control or construction permit, I have read the cautionary statement regarding contractor financial responsibility on the reverse side of the pink ply. I expressly grant the building inspector, or the inspector's authorized agent, permission to enter the premises for which this permit is sought at all reasonable hours and for any proper purpose to inspect the work which is being done.																																					
APPLICANT'S SIGNATURE _____				DATE SIGNED _____																																	
APPROVAL CONDITIONS This permit is issued pursuant to the following conditions. Failure to comply may result in suspension or revocation of this permit or other penalty.																																					
ISSUING JURISDICTION		<input type="checkbox"/> Town <input type="checkbox"/> Village <input type="checkbox"/> City <input type="checkbox"/> State of: _____			Municipality Number of Dwelling Location _____																																
FEES:		PERMIT(S) ISSUED		WIS PERMIT SEAL #		PERMIT ISSUED BY:																															
Plan Review \$ _____ Inspection \$ _____ Wis. Permit Seal \$ _____ Other \$ _____ Total \$ _____		<input type="checkbox"/> Construction <input type="checkbox"/> HVAC <input type="checkbox"/> Electrical <input type="checkbox"/> Plumbing <input type="checkbox"/> Erosion				Name _____ Date _____ Tel. _____ Cert No. _____																															

SRD-5823/R 05/98) WHITE - Issuing Jurisdiction YELLOW - State w/in 30 days if new dwelling GREEN - Inspector PINK - Owner/Agent

INSTRUCTIONS

The owner, builder or agents shall complete the application form down through the Signature of Applicant block and submit it and building plans and specifications to the enforcing municipality. Permit application data is used for statewide statistical gathering on new one- and two-family dwellings, as well as for local code administration.

PERMIT REQUESTED

- Check off type of Permit Requested, such as structural, HVAC, Electrical or Plumbing.
- Fill in owner's current Mailing Address and Telephone Number.

PROJECT LOCATION

- Fill in Building Address (number and street or sufficient information so that the building inspector can locate the construction site.
- Fill in Contractor Information. Note, per s. 101.63 (7) Wis. Stats., that the master plumber name and number must be entered before issuing a plumbing permit.
- Local zoning, land use and flood plain requirements must be satisfied before a building permit can be issued. County approval may be necessary.
- Fill in Zoning District, lot area and required building setbacks.

--
--
--
--
--
--
--
--
--
--

PROJECT DATA – Fill in all numbered project data blocks (1–14) with the required information. All data blocks must be filled in, including the following:

2. Area (involved in project):
 - Basements – include unfinished area only
 - Living area – include any finished area including finished areas in basements
 - Two-family dwellings – include total combined areas
3. Occupancy – Check only "Single-Family" or "Two-Family" if that is what is being worked on. In other words, do not check either of these two blocks if only a new detached garage is being built, even if it serves a one or two family dwelling. Instead, check "Garage" and number of stalls. If the project is a community based residential facility serving 3 to 8 residents, it is considered a single-family dwelling.
9. HVAC Equipment – Check only the major source of heat, plus central air conditioning if present. Only check "Radiant Baseboard or Panel" if there is no central source of heat.
10. Plumbing – A building permit cannot be issued until a county sanitary permit has been issued for any new or affected existing on-site sewage system.
14. Estimated Cost – Include the total cost of construction, including materials and market rate labor, but not the cost of land or landscaping.

SIGNATURE – Sign and date this application form.

CONDITIONS OF APPROVAL – The authority having jurisdiction uses this section to state any conditions that must be complied with pursuant to issuing the building permit.

--
--
--
--
--
--
--
--

ISSUING JURISDICTION: This must be completed by the authority having jurisdiction.

- Check off Municipality Status, such as town, village or city.

- Fill in Municipality Name and Municipality Number of inspection authority.
- Fill in Municipality Number of Dwelling Location if different from municipality where inspection authority is located. (applies to county or state enforcement)
- Check off type of Permit Issued, such as construction, HVAC, electrical or plumbing.
- Fill in Wisconsin Uniform Permit Seal Number, if project is a new one- or two-family dwelling.
- Fill in Name and Inspector Certification Number of person reviewing building plans and date building permit issued.

PLEASE RETURN YELLOW COPY WITHIN 30 DAYS AFTER ISSUANCE TO (You may fold along the dashed lines and insert this form into a window envelope.):

**Safety & Buildings Division
P O Box 2509
Madison, WI 53701-2509**

CAUTIONARY STATEMENT TO OWNERS OBTAINING BUILDING PERMITS

101.65 (1r) of the Wisconsin Statutes requires municipalities that enforce the Uniform Dwelling Code to provide an owner who applies for a building permit with a statement advising the owner that:

If the owner hires a contractor to perform work under the building permit and the contractor is not bonded or insured as required under s. 101.654 (2) (a), the following consequences might occur:

(a) The owner may be held liable for any bodily injury to or death of others or for any damage to the property of others that arises out of the work performed under the building permit or that is caused by any negligence of the contractor that occurs in connection with the work performed under the building permit.

(b) The owner may not be able to collect from the contractor damages for any loss sustained by the owner because of a violation by the contractor of the one- and 2- family dwelling code or an ordinance enacted under sub. (1) (a), because of any bodily injury to or death of others or damage to the property of others that arises out of the work performed under the building permit or because of any bodily injury to or death of others or damage to the property of others that is caused by any negligence by the contractor that occurs in connection with the work performed under the building permit.

Work shall not proceed until the inspector has approved the various stages of construction or the 48 business hr. period since notification has elapsed. This permit will expire 24 months after the date of issuance if the building's exterior has not been completed. **Keep this card posted until final inspection has been made.** (WI Stats. 101.63)

WISCONSIN UNIFORM

BUILDING

PERMIT # _____

affix uniform permit seal here (when applicable)
Seal No _____

const hvac elec plumb erosion

Project: _____
Issued to _____

OWNER (AGENT)

BUILDING SITE ADDRESS

CITY, VILLAGE, TOWN

Issued by	PERSON ISSUING	CERT. NO.
	DATE ISSUED	TELEPHONE

Comments: _____

NOTICE OF NONCOMPLIANCE: This issuing jurisdiction shall notify the applicant in writing of any violations to be corrected. All cited violations shall be corrected within 30 days of notification, unless extension-time is granted.

SBD-5824 (R. 05/96)

SITE INFO

SUBDIVISION _____

LOT NO. _____ BLOCK NO. _____

ZONING DISTRICT _____

_____ 1/4, SEC _____ T _____ N, R _____ E or W

PARCEL NO. _____

SETBACKS: _____

FRONT _____ ft REAR _____ ft

LEFT _____ ft RIGHT _____ ft

INSPECTIONS

PHASE	EROSION	
	ROUGH	FINAL
FOOTING		
FOUNDATION		
BSMT DRAIN TILES		
CONSTRUCTION		
PLUMBING		
HEAT/VENT/AC		
ELECTRICAL		
INSULATION		
OCCUPANCY		

CONTRACTORS

G.C.	# _____
HVAC	# _____
ELECT.	# _____
PLBG.	# _____

DO NOT REMOVE

OFFICIAL MUNICIPAL NOTICE OF VIOLATION

LOCATION: _____

- LACKING _____ PERMIT(S) NEED FOR _____ INSPECTION
- EXPIRED _____ PERMIT PREMISES HOUSEKEEPING
- UNFIT FOR HUMAN OCCUPANCY
- EROSION CONTROL PERIMETER MEASURES INSTALL MAINTAIN
- ROCK DRIVEWAY INSTALL MAINTAIN
- SEDIMENT CLEANUP STREET & SIDEWALKS ADJOINING PROPERTY

OTHER: _____

ACTION:

- CONTACT INSPECTOR NOW AFTER CORRECTIONS
- CORRECT NOW BY END OF TODAY (TRACKING CLEANUP)
 - BY END OF NEXT WORKDAY (SEDIMENT CLEANUP)
 - IN 72 HRS (EROSION CONTROLS) BY _____
- STOP ALL WORK EXCEPT CORRECTIONS

FAILURE TO COMPLY SUBJECTS YOU TO APPLICABLE FINES & PENALTIES

MUNICIPAL INSPECTOR

PHONE NUMBER

DATE

SBD-10266 (N.10/95)

Safety and Buildings Division
201 W. Washington Avenue
P O Box 7162
Madison, WI 53707-7162
Telephone: (608) 266-3151

**PETITION FOR VARIANCE
INFORMATION AND INSTRUCTIONS – ILHR 3**

In instances where exact compliance with a particular code requirement cannot be met or alternative designs are desired, the Division has a petition for variance program where it reviews and considers acceptance of alternatives which are not in strict conformance with the letter of the code, but which meet the intent of the code.

A variance is not a waiver from a code requirement. The petitioner must **provide an equivalency which meets the intent** of the code section petitioned to obtain a variance. Documentation of the rationale for the equivalency is requested below. Failure to provide adequate information may delay your petition. Pictures, sketches, and plans may be submitted to support equivalency. If the proposed equivalency does not adequately safeguard the health, safety, and welfare of building occupants, frequenters, firefighters, etc., the variance request will be denied. **NOTE: A SEPARATE PETITION IS REQUIRED FOR EACH BUILDING AND EACH CODE ISSUE PETITIONED** (i.e., 57.13 window issue cannot be processed on the same petition as 51.16 stair issue). It should be noted that **a petition for variance does not take the place of any required plan review submittal.**

The Division is unable to process petitions for variance that are not properly completed. Before submitting the application, the following items should be checked for completeness in order to avoid delays:

- Petitioner’s name (typed or printed)
- Petitioner’s signature
- The Petition For Variance Application must be signed by the owner of the building or project unless a Power of Attorney is submitted.
- Notary Public signature with affixed seal
- Analysis to establish equivalency, including any pictures, illustrations or sketches of the existing and proposed conditions to clearly convey your proposal to the reviewer.
- Proper fee
- Any required position statements by fire chief or municipal official

A position statement from the chief of the local fire department is required for fire safety issues. **No position statement is required for non-fire safety topics such as sanitary and energy conservation.** Position statements for both the fire department and municipality are required for ILHR 69 barrier-free petitions. For rules relating to one- and two-family dwellings, only a position statement from the local enforcing municipality is required. Position statements must be completed and signed by the appropriate fire chief or municipal enforcement official. See the back of SBD-9890, Petition For Variance Application form for these position statement forms. Signatures or seals on all documents must be originals. Photocopies are not acceptable.

SBD-9890 (R.01/98)

Contact numbers and fees for the Division’s review of the petition for variance are as follows:

Chapters ILHR 20–25, Uniform Dwelling Code	(608) 267–5113
\$125.00	
Chapters ILHR 67–68, Rental Unit Energy Efficiency Code	(608) 266–1930
\$125.00	
Chapters ILHR 50–64, Commercial Building Code	(608) 266–1835
\$490.00	
Chapter ILHR 66, Uniform Multi–Family Dwellings	(608) 266–0669
\$490.00	
<ul style="list-style-type: none"> The cities of Milwaukee and Madison may process requests for variances from Chapters ILHR 50 through 64 requirements on projects in their jurisdiction.) 	
Chapter ILHR 66, Multifamily Dwelling	(608) 266–1930
\$490.00	
Chapter ILHR 69, Barrier–Free Requirements	(414) 548–8609
\$200.00	
Chapter ILHR 70, Historic Building Code	(715) 524–3626
\$300.00	
All Other Chapters
\$200.00	
Boilers and Pressure Vessels	(414) 548–8617
Electrical	(608) 266–7529
Elevators	(414) 521–5444
Flammable Liquids	(608) 266–7529

Priority Review: Does not apply to Uniform Dwelling Code or Historic Building Code issues which already are treated as a priority Double Above Amounts Except for special cases, the Division will review and make a determination on a petition for variance within 30 business days of receipt of all calculations, documents, and fees required for the review. Uniform Dwelling Code petitions will be processed within 5 business days. Priority petitions will be processed within 10 business days.

Petitions for variance should be submitted to:

**Safety and Buildings Division
201 West Washington Avenue
P O Box 7162
Madison, Wisconsin 53707
(608) 266–3151**

Elevator or barrier–free petitions may be submitted directly to the Waukesha office.

General Plumbing or Private Sewage petitions may be submitted to any of the six full–service offices.

GREEN BAY S&BD	HAYWARD S&BD	LACROSSE S&BD	MADISON S&BD	SHAWANO S&BD	WAUKESHA S&BD
2331 San Luis Place Green Bay, WI 54304 920–492–5601 FAX: 920–492–5604	15837 USH 63 Hayward, WI 54843 715–634–4870 FAX: 715–634–5150	2226 Rose Street La Crosse, WI 54603 608–785–9334 FAX: 608–785–9330	201 W. Washington Ave. P.O. Box 7162 Madison, WI 53707–7162 608–261–8490 FAX: 608–267–9566	1340 Green Bay St Shawano, WI 54166 715–524–3626 FAX: 715–524–3633	401 Pilot Court Waukesha, WI 53188 414–548–8600 FAX: 414–548–8614

Dept. Use Only Plan No.

PETITION FOR VARIANCE APPLICATION

Safety and Buildings
Division
201 W. Washington Ave.
P.O. Box 7162
Madison, WI 53707
Page 1 of

PLEASE TYPE OR PRINT CLEARLY - Personal information you provide may be used for secondary purposes [Privacy Law, s.15.04 (1)(m)].

1. Owner Information		2. Project Information		3. Designer Information	
Name		Building Occupancy Chapter(s) and Use		Designer	Registration No.
Company Name		Tenant Name (if any)		Design Firm	
Number and Street		Building Location (number and street)		Number and Street	
City, State, Zip Code		<input type="checkbox"/> City <input type="checkbox"/> Village <input type="checkbox"/> Township of		City, State, Zip Code	
Contact Person		County of		Contact Person	
Telephone Number () ()	FAX Number () ()	Property ID # (tax parcel # - contact county)		Telephone Number () ()	FAX Number () ()

4. Plan Review Status

<input type="checkbox"/> On hold	<input type="checkbox"/> Already built
<input type="checkbox"/> Preliminary design	<input type="checkbox"/> Built according to older code but must be brought into compliance with current code
<input type="checkbox"/> Approved, requesting revision	<input type="checkbox"/> Plan will be submitted after petition determination
<input type="checkbox"/> Submitted with petition	<input type="checkbox"/> Other

Review by
 State Municipality

Plan Number _____

5. State the code section being petitioned AND the specific condition or issue you are requesting be covered under this petition for variance.

6. Reason why compliance with the code cannot be attained without the variance. _____

7. State your proposed means and rationale of providing equivalent degree of health, safety, or welfare as addressed by the code section petitioned.

8. List attachments to be considered as part of the petitioner's statements (i.e., model code sections, test reports, research articles, expert opinion, previously approved variances, pictures, plans, sketches, etc.).

VERIFICATION BY OWNER - PETITION IS VALID ONLY IF NOTARIZED WITH AFFIXED SEAL AND ACCOMPANIED BY REVIEW FEE (See Section Comm 2.52 for complete fee information)

Note: Petitioner must be the owner of the building or project. Tenants, agents, designers, contractors, attorneys, etc., shall not sign petition unless Power of Attorney is submitted with the Petition for Variance Application.

_____, being duly sworn, I state as petitioner that I have read the foregoing petition and I believe it is true and that I have significant ownership rights to the subject building or project.

Petitioner's Name (type or print)	Subscribed and sworn to before me this date	Notary Public	My commission expires on
Petitioner's Signature			

Complete other side for variance requests from ILHR 20-25 and ILHR 50-64.

Owner's Name	Project Location	Plan Number
--------------	------------------	-------------

Page 2 of _____

Fire Department Position Statement

To be completed for variances requested from ILHR 50-64, ILHR 69, ILHR 10, and other fire related requirements.

I have read the application for variance and recommend: (check appropriate box)

Approval Conditional Approval Denial No Comment

Explanation for recommendation including any conflicts with local rules and regulations and suggested conditions:

Fire Department Name and Address	
Name of Fire Chief or Designee (type or print)	Telephone Number
Signature of Fire Chief or Designee	Date Signed

MUNICIPAL BUILDING INSPECTION RECOMMENDATION

To be completed for variances requested from ILHR 20-23. Also to be used if ILHR 50-64 plan review is by municipality or orders are written on the building under construction; optional in other cases.

I have read the application for variance and recommend: (check appropriate box)

Approval Conditional Approval Denial No Comment

Explanation for recommendation including any conflicts with local rules and regulations and suggested conditions:

Municipality Exercising Jurisdiction	
Name and Address of Municipal Official (type or print)	Telephone Number of Enforcement Official
Signature of Municipal Enforcement Official	Date Signed

SBD-9890 (R.01/98)

SANITARY PERMIT REQUIREMENTS

Section Comm 20.09 (5) (b) 1. refers to s. Comm 83.25 (2), which reads as follows:

Comm 83.25 (2) ISSUANCE OF BUILDING PERMITS. (a) *General.* Pursuant to s. 66.036, Stats., the issuance of building permits by a municipality for unsewered properties shall be in accordance with this subsection.

(b) *New construction.* A municipality may not issue a building permit to commence construction or installation of a structure that necessitates the use of a POWTS to serve the structure, unless:

- 1. The owner of the property possesses a sanitary permit for the installation of a POWTS in accordance with s. Comm 83.21; or

Note: Section Comm 83.21 outlines the procedures for the issuance of sanitary permits. Sections 145.135 and 145.19, Stats., mandate that no private sewage system may be installed unless the owner of the property holds a valid sanitary permit.

- 2. A POWTS of adequate capability and capacity to accommodate the wastewater flow and contaminant load already exists to serve the structure.

Note: See ss. Comm 83.02 and 83.03 concerning the application of current code requirements to existing POWTS.

(c) *Construction affecting wastewater flow or contaminant load.* 1. A municipality may not issue a building permit to commence construction of any addition or alteration to an existing structure when the proposed construction will modify the design wastewater flow or contaminant load, or both, to an existing POWTS, unless the owner of the property:

- a. Possesses a sanitary permit to either modify the existing POWTS or construct a POWTS to accommodate the modification in wastewater flow or contaminant load, or both; or
- b. Provides documentation to verify that the existing POWTS is sufficient to accommodate the modification in wastewater flow or contaminant load, or both.

- 2. For the purpose of this paragraph, a modification in wastewater flow or contaminant load shall be considered to occur:

- a. For commercial facilities, public buildings, and places of employment, when there is a proposed change in occupancy of the structure; or the proposed modification affects either the type or number of plumbing appliances, fixtures or devices discharging to the system; and
- b. For dwellings, when there is an increase or decrease in the number of bedrooms.

(d) *Documentation of existing capabilities.* Documentation to verify whether an existing POWTS can accommodate a modification in wastewater flow or contaminant load, or both, shall include at least one of the following:

- 1. A copy of the plan for the existing POWTS that delineates minimum and maximum performance capabilities and which has been previously approved by the department or the governmental unit.
- 2. Information on the performance capabilities for the existing POWTS that has been recognized through a product approval under ch. Comm 84.
- 3. A written investigative report prepared by an architect, engineer, designer of plumbing systems, designer of private sewage systems, master plumber, master plumber–restricted service or certified POWTS inspector analyzing the proposed modification and the performance capabilities of the existing POWTS.

(e) *Setbacks.* 1. A municipality may not issue a building permit for construction of any structure or addition to a structure on a site where there exists a POWTS, unless the proposed construction conforms to the applicable setback limitations under s. Comm 83.43 (8) (i).

- 2. The applicant for a building permit shall provide documentation to the municipality issuing the building permit showing the location and setback distances for the proposed construction relative to all of the following:

- a. Existing POWTS treatment components.
- b. Existing POWTS holding components.
- c. Existing POWTS dispersal components.

Note: A municipality which issues building permits may delegate to the governmental unit responsible for issuing sanitary permits the determination of whether the proposed construction will affect or interfere with an existing POWTS relating to capability or location of the existing POWTS.

MINIMUM FASTENER SCHEDULE TABLE

**Other interior and exterior panel products and finishes installed per manufacturer requirements.
For engineered connectors, use manufacturer's specified fasteners.**

Description of Building Materials/Connection	Number and Type of Fastener ^{1 2 3}
Floor Framing	
Joist to sill or girder, toe nail	2-16d, 3-8d
Band or rim joist to joist, end nail	3-16d
Band or rim joist to sill or top plate	2-16d at 16" o.c.
Bridging to joist, toe nail each end	2-8d
Built-up girder and beams, top loaded	10d at 32" o.c. at top and bottom and staggered and two at ends and at each splice
Built-up girder and beams, side-loaded	16d at 16" o.c. at top and bottom and staggered and two at ends and at each splice
Ledger strip to beam, face nail	3-16d each joist
Joist on ledger to beam, toe nail	3-8d
Wall Framing	
Sole plate to joist or blocking, face nail	16d at 16" o.c.
Top or sole plate to stud, end nail	2-16d
Stud to sole plate, toe nail	4-8d or 3-16d
Doubled studs, face nail	16d at 24" o.c.
Doubled top plates, face nail	16d at 16" o.c.
Top plates, laps and intersections, face nail	2-16d
Continuous header, two pieces	16d at 16" o.c. along each edge
Continuous header to stud, toe nail	4-8d
1" corner brace to each stud and plate, face nail	2-8d or 2 staples, 1 3/4"
Built-up corner studs	16d at 30" o.c., 16d at 24" o.c.
Roof/Ceiling Framing	
Ceiling joists to plate, toe nail	2-16d, 3-8d
Ceiling joist, laps over partitions, face nail	3-16d
Ceiling joist to parallel rafters, face nail	3-16d
Rafter to plate, toe nail (maximum 6' rafter span, engineered connector for longer)	2-16d, 3-8d
Roof rafters to ridge, valley or hip rafters, toe nail	4-16d
Roof rafters to ridge, valley or hip rafters, face nail	3-16d
Collar ties to rafters, face nail	3-8d
Boards and planks	
1" x 6" subfloor or less to each joist, face nail	2-8d or 2 staples, 1 3/4"
Wider than 1" x 6" subfloor toe to each joist, face nail	3-8d or 4 staples 1 3/4"
2" subfloor to joist or girder, blind and face nail	2-16d
1" x 6" roof sheathing to each bearing, face nail	2-8d or 2 staples, 1 3/4"
1" x 8" roof sheathing to each bearing, face nail	2-8d or 3 staples, 1 3/4"
Wider than 1" x 8" roof sheathing to each bearing, face nail	3-8d or 4 staples, 1 3/4"
2-inch planks	2-16d at each bearing

Panel Sheathing			
Material	Fastener	Spacing of Fastener	
		Edges	Intermediate Supports
Engineered wood panel for subfloor and roof sheathing and wall corner wind bracing to framing			
5/16–inch to 1/2–inch	6d common or deformed nail or staple, 1 1/2"	6"	12" ⁴
5/8–inch to 3/4–inch	8d smooth or common, 6d deformed nail, or staple, 14 ga. 1 3/4"	6"	12" ⁴
7/8–inch to 1–inch	8d common or deformed nail	6"	12"
1 1/8–inch to 1 1/4–inch	10d smooth or common, or 8d deformed nail	6"	12"
Combination subfloor/ underlayment to framing			
3/4–inch or less	6d deformed or 8d smooth or common nail	6"	12"
7/8–inch to 1–inch	8d smooth, common or deformed nail	6"	12"
1 1/8–inch to 1 1/4–inch	10d smooth or common or 8d deformed nail	6"	12"
Wood panel siding to framing			
1/2–inch or less	6d corrosion–resistant siding and casing nails	6"	12"
5/8–inch	8d corrosion–resistant siding and casing nails	6"	12"

¹All nails are smooth–common, box or deformed shank except where otherwise stated

²Nail is a general description and may be T–head, modified round head or round head.

³Staples are 16–gauge wire, unless otherwise noted, and have a minimum 7/16–inch o.d. crown width.

⁴Staples shall be spaced at not more than 10 inches o.c. at intermediate supports for floors.

**UDC Floor & Ceiling Joist and Roof Rafter Span Tables
And Design Value Tables**

Use the following Span Tables to determine the maximum spans for floor and ceiling joists and roof rafters. These spans are based on:

- simple, single spans (although the tables may be safely used for continuous two-span floor joists)
- uniformly distributed loads
- fully supported members with one edge properly sheathed and nailed
- for floor joists and roof rafters, the top edge shall be properly sheathed and nailed

The criteria for each Span Table is given in the upper left hand corner and is also summarized in the table of Span Tables below. Choose the appropriate Span Table based on the member type and required loading. Select your desired member depth, member spacing and span to determine the minimum Fb value. Note that these tables include recommended deflection criteria. However, for strict code compliance, only the Fb strength requirements must be satisfied. The modulus of elasticity (E) values, would be met for serviceability purposes only.

Note that straight-line interpolation is permitted for intermediate spans and design values. Span is measured from face to face of supports. For sloping rafters, the span is measured along the horizontal projection.

Section Comm 21.27 allows reduction of the snow live load for roof slopes greater than 30 degrees (7/12 slope) based on the formula $C_s = 1 - (a-30)/40$, where "a" is the slope of the roof expressed in degrees. Following is a table of tabulated values for certain roof slopes.

Slope	Angle in Degrees	Zone 1 Live Load (psf)	Zone 2 Live Load (psf)
7/12	30	40	30
10/12	40	30	22.5
12/12	45	25	18.8
14/12	50	20	15

Use the Design Value tables following the Span Tables to determine the acceptable species and grades to satisfy minimum Fb values obtained from the Span Tables. The Design Value tables assume at least three members spaced no more than 24" on center. Use the Normal Duration column Fb values for joists and the Snow Loading column Fb values for rafters.

See the following examples for further guidance.

Tables are reprinted courtesy of American Forest & Paper Association.

Table No.	Member Type	Live Load (psf)	Dead Load (psf)	Condition	(Deflection)*
F-2	Floor Joists	40	10	–	L/360
C-1	Ceiling Joists	10	5	Drywall ceiling, no attic storage	L/240
C-2	Ceiling Joists	20	10	Attic storage	L/240
R-2	Roof Rafters	30 (Zone 2)	10	Maximum 2 layers of asphalt shingles or wood shakes/shingles	L/240
R-3	Roof Rafters	40 (Zone 1)	10	Maximum 2 layers of asphalt shingles or wood shakes/shingles	L/240
R-10	Roof Rafters	30 (Zone 2)	20	Heavy roof covering (clay tile)	L/240
R-11	Roof Rafters	40 (Zone 1)	20	Heavy roof covering (clay tile)	L/240
R-14	Roof Rafters	30 (Zone 2)	10	Maximum 2 layers of asphalt shingles or wood shakes/shingles	L/180
R-15	Roof Rafters	40 (Zone 1)	10	Maximum 2 layers of asphalt shingles or wood shakes/shingles	L/180
R-22	Roof Rafters	30 (Zone 2)	20	Heavy roof covering (clay tile)	L/180
R-23	Roof Rafters	40 (Zone 1)	20	Heavy roof covering (clay tile)	L/180

*Deflection criteria are optional. For roof rafters with drywall on the underside, use the stricter L/240 tables to limit deflection.

Example 1. Floor Joists. Assume a required single span of 12’-9”, live load of 10 psf and joists spaced 16 inches on center. Table F-2 (see following highlighted tables) shows that one solution is a grade of 2x8 having an Fb value of 1255 would allow a span of 12’-10 which satisfies the condition. (Note that the recommended E value to limit deflection would be 1,600,000.) Going to the Design Value Tables, we find that as an example, 2x8 Hem Fir grade No.1 has an Fb value of 1310 for normal duration. (It also has an E value of 1,500,000 which satisfies the recommended deflection criteria.)

Example 2. Rafters. Assume a horizontal projected span of 13’-0”, a live load of 40 psf, dead load of 10 psf, a roof slope of 4/12 and rafters spaced 16 inches on center. Since the slope is shallower than 7/12, there is no allowable reduction of the snow live load. Table R-3 shows that a 2x8 having an Fb value of 1300 would allow a span of 13’-1” which satisfies the condition. (Note that the recommended E value to limit deflection would be 1,120,000.) Going to the Design Value Tables, we find that as an example, 2x8 Douglas Fir-Larch grade No.2 has an Fb value of 1390 for snow loading. (It also has an E value of 1,600,000 which satisfies the recommended deflection criteria.)

Example 1
TABLE F-2
FLOOR JOISTS WITH L/360 DEFLECTION LIMITS

DESIGN CRITERIA:
 Deflection - For 40 psf live load.
 Limited to span in inches divided by 360.
 Strength - Live load of 40 psf plus dead load of 10 psf determines the required bending design value.

Joist Size (in)	Spacing (in)	Modulus of Elasticity, E, in 1,000,000 psi																
		0.8	0.9	1.0	1.1	1.2	1.3	1.4	1.5	1.6	1.7	1.8	1.9	2.0	2.1	2.2	2.3	2.4
2x6	12.0	8-6	8-10	9-2	9-6	9-9	10-0	10-3	10-6	10-9	10-11	11-2	11-4	11-7	11-9	11-11	12-1	12-3
	16.0	7-9	8-0	8-4	8-7	8-10	9-1	9-4	9-6	9-9	9-11	10-2	10-4	10-6	10-8	10-10	11-0	11-2
	19.2	7-3	7-7	7-10	8-1	8-4	8-7	8-9	9-0	9-2	9-4	9-6	9-8	9-10	10-0	10-2	10-4	10-6
	24.0	6-9	7-0	7-3	7-6	7-9	7-11	8-2	8-4	8-6	8-8	8-10	9-0	9-2	9-4	9-6	9-7	9-9
2x8	12.0	11-3	11-8	12-1	12-6	12-10	13-2	13-6	13-10	14-2	14-5	14-8	15-0	15-3	15-6	15-9	15-11	16-2
	16.0	10-2	10-7	11-0	11-4	11-8	12-0	12-3	12-7	12-10	13-1	13-4	13-7	13-10	14-1	14-3	14-6	14-8
	19.2	9-7	10-0	10-4	10-8	11-0	11-3	11-7	11-10	12-1	12-4	12-7	12-10	13-0	13-3	13-5	13-8	13-10
	24.0	8-11	9-3	9-7	9-11	10-2	10-6	10-9	11-0	11-3	11-5	11-8	11-11	12-1	12-3	12-6	12-8	12-10
2x10	12.0	14-4	14-11	15-5	15-11	16-5	16-10	17-3	17-8	18-0	18-5	18-9	19-1	19-5	19-9	20-1	20-4	20-8
	16.0	13-0	13-6	14-0	14-6	14-11	15-3	15-8	16-0	16-5	16-9	17-0	17-4	17-8	17-11	18-3	18-6	18-9
	19.2	12-3	12-9	13-2	13-7	14-0	14-5	14-9	15-1	15-5	15-9	16-0	16-4	16-7	16-11	17-2	17-5	17-8
	24.0	11-4	11-10	12-3	12-8	13-0	13-4	13-8	14-0	14-4	14-7	14-11	15-2	15-5	15-8	15-11	16-2	16-5
2x12	12.0	17-5	18-1	18-9	19-4	19-11	20-6	21-0	21-6	21-11	22-5	22-10	23-3	23-7	24-0	24-5	24-9	25-1
	16.0	15-10	16-5	17-0	17-7	18-1	18-7	19-1	19-6	19-11	20-4	20-9	21-1	21-6	21-10	22-2	22-6	22-10
	19.2	14-11	15-6	16-0	16-7	17-0	17-6	17-11	18-4	18-9	19-2	19-6	19-10	20-2	20-6	20-10	21-2	21-6
	24.0	13-10	14-4	14-11	15-4	15-10	16-3	16-8	17-0	17-5	17-9	18-1	18-5	18-9	19-1	19-4	19-8	19-11
F _b	12.0	718	777	833	888	941	993	1043	1092	1140	1187	1233	1278	1323	1367	1410	1452	1494
	16.0	790	855	917	977	1036	1093	1148	1202	1255	1306	1357	1407	1456	1504	1551	1598	1644
	19.2	840	909	975	1039	1101	1161	1220	1277	1333	1388	1442	1495	1547	1598	1649	1698	1747
	24.0	905	979	1050	1119	1186	1251	1314	1376	1436	1496	1554	1611	1667	1722	1776	1829	1882

Note: The required bending design value, F_b, in pounds per square inch is shown at the bottom of each table and is applicable to all lumber sizes shown. Spans are shown in feet-inches and are limited to 26' and less. Check sources of supply for availability of lumber in lengths greater than 20'.

Example 1

Species and Grade	Size	Design Value in Bending, "Fb"		Modulus of Elasticity "E"	Grading Rules Agency	
		Normal Duration	Snow Loading			
Eastern White Pine						
Select Structural	2x4	2155	2480	1,200,000	NELMA NSLB	
No.1		1335	1535	1,100,000		
No.2		990	1140	1,100,000		
No.3		605	695	900,000		
Stud		570	655	900,000		
Construction		775	895	1,000,000		
Standard		430	495	900,000		
Utility		200	230	800,000		
Select Structural		2x6	1870	2150		1,200,000
No.1	1160		1330	1,100,000		
No.2	860		990	1,100,000		
No.3	525		600	900,000		
Stud	520		595	900,000		
Select Structural	2x8	1725	1985	1,200,000		
No.1		1070	1230	1,100,000		
No.2		795	915	1,100,000		
No.3		485	555	900,000		
Select Structural	2x10	1580	1820	1,200,000		
No.1		980	1125	1,100,000		
No.2		725	835	1,100,000		
No.3		445	510	900,000		
Select Structural	2x12	1440	1655	1,200,000		
No.1		890	1025	1,100,000		
No.2		660	760	1,100,000		
No.3		405	465	900,000		
Hem Fir						
Select Structural	2x4	2415	2775	1,600,000		WCLIB WWPA
No.1 & Btr		1810	2085	1,500,000		
No.1		1640	1885	1,500,000		
No.2		1465	1685	1,300,000		
No.3		865	990	1,200,000		
Stud		855	980	1,200,000		
Construction		1120	1290	1,300,000		
Standard		635	725	1,200,000		
Utility		290	330	1,100,000		
Select Structural	2x6	2095	2405	1,600,000		
No.1 & Btr		1570	1805	1,500,000		
No.1		1420	1635	1,500,000		
No.2		1270	1460	1,300,000		
No.3		750	860	1,200,000		
Stud		775	895	1,200,000		
Select Structural		2x8	1930	2220	1,600,000	
No.1 & Btr	1450		1665	1,500,000		
No.1	1310		1510	1,500,000		
No.2	2x10	1175	1350	1,300,000		
No.3		690	795	1,200,000		
Select Structural		1770	2035	1,600,000		
No.1 & Btr	2x12	1330	1525	1,500,000		
No.1		1200	1380	1,500,000		
No.2		1075	1235	1,300,000		
No.3		635	725	1,200,000		
Select Structural		1610	1850	1,600,000		
No.1 & Btr		1210	1390	1,500,000		
No.1	2x12	1095	1255	1,500,000		
No.2		980	1125	1,300,000		
No.3		575	660	1,200,000		

Example 2
TABLE R-3
RAFTERS WITH L/240 DEFLECTION LIMITATION

DESIGN CRITERIA:
 Strength - Live Load of 40 psf plus Dead Load of 10 psf determines the required bending design value.
 Deflection - For 40 psf live load. Limited to span in inches divided by 240.

Size (in)	Spacing (in)	Rafter Bending Design Value, F_b (psi)																							
		300	400	500	600	700	800	900	1000	1100	1200	1300	1400	1500	1600	1700	1800	1900	2000	2100	2200	2300	2400		
2x6	12.0	5-6	6-4	7-1	7-9	8-5	9-0	9-6	10-0	10-6	11-0	11-5	11-11	12-4	12-8	13-1	13-6	13-10	14-2						
	16.0	4-9	5-6	6-2	6-9	7-3	7-9	8-3	8-8	9-1	9-6	9-11	10-3	10-8	11-0	11-4	11-8	12-0	12-4	12-7	12-11				
	19.2	4-4	5-0	5-7	6-2	6-8	7-1	7-6	7-11	8-4	8-8	9-1	9-5	9-9	10-0	10-4	10-8	10-11	11-3	11-6	11-9	12-0	12-4		
	24.0	3-11	4-6	5-0	5-6	5-11	6-4	6-9	7-1	7-5	7-9	8-1	8-5	8-8	9-0	9-3	9-6	9-9	10-0	10-3	10-6	10-9	11-0		
2x8	12.0	7-3	8-4	9-4	10-3	11-1	11-10	12-7	13-3	13-11	14-6	15-1	15-8	16-3	16-9	17-3	17-9	18-3	18-9						
	16.0	6-3	7-3	8-1	8-11	9-7	10-3	10-10	11-6	12-0	12-7	13-1	13-7	14-0	14-6	14-11	15-5	15-10	16-3	16-7	17-0				
	19.2	5-9	6-7	7-5	8-1	8-9	9-4	9-11	10-6	11-0	11-6	11-11	12-5	12-10	13-3	13-8	14-0	14-5	14-10	15-2	15-6	15-10	16-3		
	24.0	5-2	5-11	6-7	7-3	7-10	8-4	8-11	9-4	9-10	10-3	10-8	11-1	11-6	11-10	12-2	12-7	12-11	13-3	13-7	13-11	14-2	14-6		
2x10	12.0	9-3	10-8	11-11	13-1	14-2	15-1	16-0	16-11	17-9	18-6	19-3	20-0	20-8	21-4	22-0	22-8	23-3	23-11						
	16.0	8-0	9-3	10-4	11-4	12-3	13-1	13-10	14-8	15-4	16-0	16-8	17-4	17-11	18-6	19-1	19-7	20-2	20-8	21-2	21-8				
	19.2	7-4	8-5	9-5	10-4	11-2	11-11	12-8	13-4	14-0	14-8	15-3	15-10	16-4	16-11	17-5	17-11	18-5	18-11	19-4	19-10	20-3	20-8		
	24.0	6-6	7-7	8-5	9-3	10-0	10-8	11-4	11-11	12-6	13-1	13-7	14-2	14-8	15-1	15-7	16-0	16-6	16-11	17-4	17-9	18-1	18-6		
2x12	12.0	11-3	13-0	14-6	15-11	17-2	18-4	19-6	20-6	21-7	22-6	23-5	24-4	25-2	26-0										
	16.0	9-9	11-3	12-7	13-9	14-11	15-11	16-10	17-9	18-8	19-6	20-3	21-1	21-9	22-6	23-2	23-10	24-6	25-2	25-9					
	19.2	8-11	10-3	11-6	12-7	13-7	14-6	15-5	16-3	17-0	17-9	18-6	19-3	19-11	20-6	21-2	21-9	22-5	23-0	23-6	24-1	24-8	25-2		
	24.0	7-11	9-2	10-3	11-3	12-2	13-0	13-9	14-6	15-3	15-11	16-7	17-2	17-9	18-4	18-11	19-6	20-0	20-6	21-1	21-7	22-0	22-6		
E	12.0	0.14	0.22	0.31	0.41	0.51	0.63	0.75	0.88	1.01	1.15	1.30	1.45	1.61	1.77	1.94	2.12	2.30	2.48						
	16.0	0.12	0.19	0.27	0.35	0.44	0.54	0.65	0.76	0.88	1.00	1.12	1.26	1.39	1.54	1.68	1.83	1.99	2.15	2.31	2.48				
	19.2	0.11	0.18	0.24	0.32	0.41	0.50	0.59	0.69	0.80	0.91	1.03	1.15	1.27	1.40	1.54	1.67	1.81	1.96	2.11	2.26	2.42	2.58		
	24.0	0.10	0.16	0.22	0.29	0.36	0.44	0.53	0.62	0.71	0.81	0.92	1.03	1.14	1.25	1.37	1.50	1.62	1.75	1.89	2.02	2.16	2.30		

Note: The required modulus of elasticity, E, in 1,000,000 pounds per square inch is shown at the bottom of each table, is limited to 2.6 million psi and less, and is applicable to all lumber sizes shown. Spans are shown in feet-inches and are limited to 26' and less. Check sources of supply for availability of lumber in lengths greater than 20'.

Example 2

Species and Grade	Size	Design Value in Bending, "Fb"		Modulus of Elasticity "E"	Grading Rules Agency	
		Normal Duration	Snow Loading			
Cottonwood						
Select Structural	2x4	1510	1735	1,200,000	NSLB	
No.1		1080	1240	1,200,000		
No.2		1080	1240	1,100,000		
No.3		605	695	1,000,000		
Stud		600	690	1,000,000		
Construction		805	925	1,000,000		
Standard		460	530	900,000		
Utility		200	230	900,000		
Select Structural		2x6	1310	1505		1,200,000
No.1			935	1075		1,200,000
No.2	935		1075	1,100,000		
No.3	525		600	1,000,000		
Stud	545	630	1,000,000			
Select Structural	2x8	1210	1390	1,200,000		
No.1		865	990	1,200,000		
No.2		865	990	1,100,000		
No.3		485	555	1,000,000		
Select Structural	2x10	1105	1275	1,200,000		
No.1		790	910	1,200,000		
No.2		790	910	1,100,000		
No.3		445	510	1,000,000		
Select Structural	2x12	1005	1155	1,200,000		
No.1		720	825	1,200,000		
No.2		720	825	1,100,000		
No.3		405	465	1,000,000		
Douglas Fir-Larch						
Select Structural	2x4	2500	2875	1,900,000	WCLIB WWPA	
No.1 & Btr		1985	2280	1,800,000		
No.1		1725	1985	1,700,000		
No.2		1510	1735	1,600,000		
No.3		865	990	1,400,000		
Stud		855	980	1,400,000		
Construction		1150	1325	1,500,000		
Standard		635	725	1,400,000		
Utility		315	365	1,300,000		
Select Structural		2x6	2170	2495		1,900,000
No.1 & Btr	1720		1975	1,800,000		
No.1	1495		1720	1,700,000		
No.2	1310		1505	1,600,000		
No.3	750		860	1,400,000		
Stud	775		895	1,400,000		
Select Structural	2x8	2000	2300	1,900,000		
No.1 & Str		1585	1825	1,800,000		
No.1	1380	1585	1,700,000			
No.2	1210	1390	1,600,000			
No.3	690	795	1,400,000			
Select Structural	2x10	1835	2110	1,900,000		
No.1 & Btr		1455	1675	1,800,000		
No.1		1265	1455	1,700,000		
No.2		1105	1275	1,600,000		
No.3		635	725	1,400,000		
Select Structural		2x12	1670	1920	1,900,000	
No.1 & Btr	1325		1520	1,800,000		
No.1	1150		1325	1,700,000		
No.2	1005		1155	1,600,000		
No.3	575		660	1,400,000		

TABLE F-2
FLOOR JOISTS WITH L/360 DEFLECTION LIMITS

DESIGN CRITERIA:

Deflection - For 40 psf live load.
Limited to span in inches divided by 360.
Strength - Live load of 40 psf plus dead load of 10 psf determines the required bending design value.

Joist Size (in)	Modulus of Elasticity, E _s , in 1,000,000 psi																			
	0.8	0.9	1.0	1.1	1.2	1.3	1.4	1.5	1.6	1.7	1.8	1.9	2.0	2.1	2.2	2.3	2.4			
12.0	8-6	8-10	9-2	9-6	9-9	10-0	10-3	10-6	10-9	10-11	11-2	11-4	11-7	11-9	11-11	12-1	12-3			
16.0	7-9	8-0	8-4	8-7	8-10	9-1	9-4	9-6	9-9	9-11	10-2	10-4	10-6	10-8	10-10	11-0	11-2			
19.2	7-3	7-7	7-10	8-1	8-4	8-7	8-9	9-0	9-2	9-4	9-6	9-8	9-10	10-0	10-2	10-4	10-6			
24.0	6-9	7-0	7-3	7-6	7-9	7-11	8-2	8-4	8-6	8-8	8-10	9-0	9-2	9-4	9-6	9-7	9-9			
12.0	11-3	11-8	12-1	12-6	12-10	13-2	13-6	13-10	14-2	14-5	14-8	15-0	15-3	15-6	15-9	15-11	16-2			
16.0	10-2	10-7	11-0	11-4	11-8	12-0	12-3	12-7	12-10	13-1	13-4	13-7	13-10	14-1	14-3	14-6	14-8			
19.2	9-7	10-0	10-4	10-8	11-0	11-3	11-7	11-10	12-1	12-4	12-7	12-10	13-0	13-3	13-5	13-8	13-10			
24.0	8-11	9-3	9-7	9-11	10-2	10-6	10-9	11-0	11-3	11-5	11-8	11-11	12-1	12-3	12-6	12-8	12-10			
12.0	14-4	14-11	15-5	15-11	16-5	16-10	17-3	17-8	18-0	18-5	18-9	19-1	19-5	19-9	20-1	20-4	20-8			
16.0	13-0	13-6	14-0	14-6	14-11	15-3	15-8	16-0	16-5	16-9	17-0	17-4	17-8	17-11	18-3	18-6	18-9			
19.2	12-3	12-9	13-2	13-7	14-0	14-5	14-9	15-1	15-5	15-9	16-0	16-4	16-7	16-11	17-2	17-5	17-8			
24.0	11-4	11-10	12-3	12-8	13-0	13-4	13-8	14-0	14-4	14-7	14-11	15-2	15-5	15-8	15-11	16-2	16-5			
12.0	17-5	18-1	18-9	19-4	19-11	20-6	21-0	21-6	21-11	22-5	22-10	23-3	23-7	24-0	24-5	24-9	25-1			
16.0	15-10	16-5	17-0	17-7	18-1	18-7	19-1	19-6	19-11	20-4	20-9	21-1	21-6	21-10	22-2	22-6	22-10			
19.2	14-11	15-6	16-0	16-7	17-0	17-6	17-11	18-4	18-9	19-2	19-6	19-10	20-2	20-6	20-10	21-2	21-6			
24.0	13-10	14-4	14-11	15-4	15-10	16-3	16-8	17-0	17-5	17-9	18-1	18-5	18-9	19-1	19-4	19-8	19-11			
F _s	12.0	718	777	833	888	941	1043	1092	1140	1187	1233	1278	1323	1367	1410	1452	1494			
F _b	16.0	790	855	917	977	1036	1148	1202	1255	1306	1357	1407	1456	1504	1551	1598	1644			
F _v	19.2	840	909	975	1039	1101	1220	1277	1333	1388	1442	1495	1547	1598	1649	1698	1747			
F _t	24.0	905	979	1050	1119	1186	1314	1376	1436	1496	1554	1611	1667	1722	1776	1829	1882			

Note: The required bending design value, F_b, in pounds per square inch is shown at the bottom of each table and is applicable to all lumber sizes shown. Spans are shown in feet-inches and are limited to 26' and less. Check sources of supply for availability of lumber in lengths greater than 20'.

**TABLE C-1
CEILING JOISTS WITH L/240 DEFLECTION LIMITS**

DESIGN CRITERIA:

Deflection – For 10 psf live load.
 Limited to span in inches divided by 240.
 Strength – Live Load of 10 psf plus
 dead load of 5 psf determines the required fiber stress value.

Joist Size (in)	Spacing (in)	Modulus of Elasticity, E, in 1,000,000 psi																
		0.8	0.9	1.0	1.1	1.2	1.3	1.4	1.5	1.6	1.7	1.8	1.9	2.0	2.1	2.2	2.3	2.4
2x4	12.0	9-10	10-3	10-7	10-11	11-3	11-7	11-10	12-2	12-5	12-8	12-11	13-2	13-4	13-7	13-9	14-0	14-2
	16.0	8-11	9-4	9-8	9-11	10-3	10-6	10-9	11-0	11-3	11-6	11-9	11-11	12-2	12-4	12-6	12-9	12-11
	19.2	8-5	8-9	9-1	9-4	9-8	9-11	10-2	10-4	10-7	10-10	11-0	11-3	11-5	11-7	11-9	12-0	12-2
	24.0	7-10	8-1	8-5	8-8	8-11	9-2	9-5	9-8	9-10	10-0	10-3	10-5	10-7	10-9	10-11	11-1	11-3
2x6	12.0	15-6	16-1	16-8	17-2	17-8	18-2	18-8	19-1	19-6	19-11	20-3	20-8	21-0	21-4	21-8	22-0	22-4
	16.0	14-1	14-7	15-2	15-7	16-1	16-6	16-11	17-4	17-8	18-1	18-5	18-9	19-1	19-5	19-8	20-0	20-3
	19.2	13-3	13-9	14-3	14-8	15-2	15-7	15-11	16-4	16-8	17-0	17-4	17-8	17-11	18-3	18-6	18-10	19-1
	24.0	12-3	12-9	13-3	13-8	14-1	14-5	14-9	15-2	15-6	15-9	16-1	16-4	16-8	16-11	17-2	17-5	17-8
2x8	12.0	20-5	21-2	21-11	22-8	23-4	24-0	24-7	25-2	25-8								
	16.0	18-6	19-3	19-11	20-7	21-2	21-9	22-4	22-10	23-4	23-10	24-3	24-8	25-2	25-7	25-11		
	19.2	17-5	18-1	18-9	19-5	19-11	20-6	21-0	21-6	21-11	22-5	22-10	23-3	23-8	24-0	24-5	24-9	25-2
	24.0	16-2	16-10	17-5	18-0	18-6	19-0	19-6	19-11	20-5	20-10	21-2	21-7	21-11	22-4	22-8	23-0	23-4
2x10	12.0	26-0																
	16.0	23-8	24-7	25-5														
	19.2	22-3	23-1	23-11	24-9	25-5												
	24.0	20-8	21-6	22-3	22-11	23-8	24-3	24-10	25-5	26-0								
F _b	12.0	711	769	825	880	932	983	1033	1082	1129	1176	1221	1266	1310	1354	1396	1438	1480
	16.0	783	847	909	968	1026	1082	1137	1191	1243	1294	1344	1394	1442	1490	1537	1583	1629
	19.2	832	900	965	1029	1090	1150	1208	1265	1321	1375	1429	1481	1533	1583	1633	1682	1731
	24.0	896	969	1040	1108	1174	1239	1302	1363	1423	1481	1539	1595	1651	1706	1759	1812	1864

Note: The required bending design value, F_b, in pounds per square inch is shown at the bottom of each table and is applicable to all lumber sizes shown. Spans are shown in feet-inches and are limited to 26' and less. Check sources of supply for availability of lumber in lengths greater than 20'.

TABLE C-2
CEILING JOISTS WITH L/240 DEFLECTION LIMITS

DESIGN CRITERIA:

Deflection – For 20 psf live load.
Limited to span in inches divided by 240.
Strength – Live Load of 20 psf plus
dead load of 10 psf determines the required bending design value.

Size (in)	Spacing (in)	Joist Modulus of Elasticity, E, in 1,000,000 psi																
		0.8	0.9	1.0	1.1	1.2	1.3	1.4	1.5	1.6	1.7	1.8	1.9	2.0	2.1	2.2	2.3	2.4
2x4	12.0	7-10	8-1	8-5	8-8	8-11	9-2	9-5	9-8	9-10	10-0	10-3	10-5	10-7	10-9	10-11	11-1	11-3
	16.0	7-1	7-5	7-8	7-11	8-1	8-4	8-7	8-9	8-11	9-1	9-4	9-6	9-8	9-9	9-11	10-1	10-3
	19.2	6-8	6-11	7-2	7-5	7-8	7-10	8-1	8-3	8-5	8-7	8-9	8-11	9-1	9-3	9-4	9-6	9-8
	24.0	6-2	6-5	6-8	6-11	7-1	7-3	7-6	7-8	7-10	8-0	8-1	8-3	8-5	8-7	8-8	8-10	8-11
2x6	12.0	12-3	12-9	13-3	13-8	14-1	14-5	14-9	15-2	15-6	15-9	16-1	16-4	16-8	16-11	17-2	17-5	17-8
	16.0	11-2	11-7	12-0	12-5	12-9	13-1	13-5	13-9	14-1	14-4	14-7	14-11	15-2	15-5	15-7	15-10	16-1
	19.2	10-6	10-11	11-4	11-8	12-0	12-4	12-8	12-11	13-3	13-6	13-9	14-0	14-3	14-6	14-8	14-11	15-2
	24.0	9-9	10-2	10-6	10-10	11-2	11-5	11-9	12-0	12-3	12-6	12-9	13-0	13-3	13-5	13-8	13-10	14-1
2x8	12.0	16-2	16-10	17-5	18-0	18-6	19-0	19-6	19-11	20-5	20-10	21-2	21-7	21-11	22-4	22-8	23-0	23-4
	16.0	14-8	15-3	15-10	16-4	16-10	17-3	17-9	18-1	18-6	18-11	19-3	19-7	19-11	20-3	20-7	20-11	21-2
	19.2	13-10	14-5	14-11	15-5	15-10	16-3	16-8	17-1	17-5	17-9	18-1	18-5	18-9	19-1	19-5	19-8	19-11
	24.0	12-10	13-4	13-10	14-3	14-8	15-1	15-6	15-10	16-2	16-6	16-10	17-2	17-5	17-9	18-0	18-3	18-6
2x10	12.0	20-8	21-6	22-3	22-11	23-8	24-3	24-10	25-5	26-0								
	16.0	18-9	19-6	20-2	20-10	21-6	22-1	22-7	23-1	23-8	24-1	24-7	25-0	25-5	25-10			
	19.2	17-8	18-4	19-0	19-7	20-2	20-9	21-3	21-9	22-3	22-8	23-1	23-7	23-11	24-4	24-9	25-1	25-5
	24.0	16-5	17-0	17-8	18-3	18-9	19-3	19-9	20-2	20-8	21-1	21-6	21-10	22-3	22-7	22-11	23-4	23-8
F _b	12.0	896	969	1040	1108	1174	1239	1302	1363	1423	1481	1539	1595	1651	1706	1759	1812	1864
	16.0	986	1067	1145	1220	1293	1364	1433	1500	1566	1631	1694	1756	1817	1877	1936	1995	2052
	19.2	1048	1134	1216	1296	1374	1449	1522	1594	1664	1733	1800	1866	1931	1995	2058	2120	2181
	24.0	1129	1221	1310	1396	1480	1561	1640	1717	1793	1866	1939	2010	2080	2149	2217	2283	2349

Note: The required bending design value, F_b, in pounds per square inch is shown at the bottom of each table and is applicable to all lumber sizes shown. Spans are shown in feet-inches and are limited to 26' and less. Check sources of supply for availability of lumber in lengths greater than 20'.

**TABLE R-2
RAFTERS WITH L/240 DEFLECTION LIMITATION**

DESIGN CRITERIA:

Strength – Live Load of 30 psf plus Dead Load of 10 psf determines the required bending design value.
 Deflection – For 30 psf live load. Limited to span in inches divided by 240.

Size (in)	Spacing (in)	Rafters Design Value, F _b , (psi)																					
		300	400	500	600	700	800	900	1000	1100	1200	1300	1400	1500	1600	1700	1800	1900	2000	2100	2200	2300	2400
2x6	12.0	6-2	7-1	7-11	8-8	9-5	10-0	10-8	11-3	11-9	12-4	12-10	13-3	13-9	14-2	14-8	15-1	15-6	15-11				
	16.0	5-4	6-2	6-10	7-6	8-2	8-8	9-3	9-9	10-2	10-8	11-1	11-6	11-11	12-4	12-8	13-1	13-5	13-9	14-1	14-5		
	19.2	4-10	5-7	6-3	6-10	7-5	7-11	8-5	8-11	9-4	9-9	10-1	10-6	10-10	11-3	11-7	11-11	12-3	12-7	12-10	13-2	13-6	
	24.0	4-4	5-0	5-7	6-2	6-8	7-1	7-6	7-11	8-4	8-8	9-1	9-5	9-9	10-0	10-4	10-8	10-11	11-3	11-6	11-9	12-0	12-4
2x8	12.0	8-1	9-4	10-6	11-6	12-5	13-3	14-0	14-10	15-6	16-3	16-10	17-6	18-1	18-9	19-4	19-10	20-5	20-11				
	16.0	7-0	8-1	9-1	9-11	10-9	11-6	12-2	12-10	13-5	14-0	14-7	15-2	15-8	16-3	16-9	17-2	17-8	18-1	18-7	19-0		
	19.2	6-5	7-5	8-3	9-1	9-9	10-6	11-1	11-8	12-3	12-10	13-4	13-10	14-4	14-10	15-3	15-8	16-2	16-7	16-11	17-4	17-9	
	24.0	5-9	6-7	7-5	8-1	8-9	9-4	9-11	10-6	11-0	11-6	11-11	12-5	12-10	13-3	13-8	14-0	14-5	14-10	15-2	15-6	15-10	16-3
2x10	12.0	10-4	11-11	13-4	14-8	15-10	16-11	17-11	18-11	19-10	20-8	21-6	22-4	23-1	23-11	24-7	25-4	26-0					
	16.0	8-11	10-4	11-7	12-8	13-8	14-8	15-6	16-4	17-2	17-11	18-8	19-4	20-0	20-8	21-4	21-11	22-6	23-1	23-8	24-3		
	19.2	8-2	9-5	10-7	11-7	12-6	13-4	14-2	14-11	15-8	16-4	17-0	17-8	18-3	18-11	19-6	20-0	20-7	21-1	21-8	22-2	22-8	
	24.0	7-4	8-5	9-5	10-4	11-2	11-11	12-8	13-4	14-0	14-8	15-3	15-10	16-4	16-11	17-5	17-11	18-5	18-11	19-4	19-10	20-3	20-8
2x12	12.0	12-7	14-6	16-3	17-9	19-3	20-6	21-9	23-0	24-1	25-2												
	16.0	10-11	12-7	14-1	15-5	16-8	17-9	18-10	19-11	20-10	21-9	22-8	23-6	24-4	25-2	25-11							
	19.2	9-11	11-6	12-10	14-1	15-2	16-3	17-3	18-2	19-0	19-11	20-8	21-6	22-3	23-0	23-8	24-4	25-0	25-8				
	24.0	8-11	10-3	11-6	12-7	13-7	14-6	15-5	16-3	17-0	17-9	18-6	19-3	19-11	20-6	21-2	21-9	22-5	23-0	23-6	24-1	24-8	25-2
E	12.0	0.15	0.23	0.32	0.43	0.54	0.66	0.78	0.92	1.06	1.21	1.36	1.52	1.69	1.86	2.04	2.22	2.41	2.60				
	16.0	0.13	0.20	0.28	0.37	0.47	0.57	0.68	0.80	0.92	1.05	1.18	1.32	1.46	1.61	1.76	1.92	2.08	2.25	2.42	2.60		
	19.2	0.12	0.18	0.26	0.34	0.43	0.52	0.62	0.73	0.84	0.95	1.08	1.20	1.33	1.47	1.61	1.75	1.90	2.05	2.21	2.37	2.53	
	24.0	0.11	0.16	0.23	0.30	0.38	0.46	0.55	0.65	0.75	0.85	0.96	1.08	1.19	1.31	1.44	1.57	1.70	1.84	1.98	2.12	2.27	2.41

Note: The required modulus of elasticity, E, in 1,000,000 pounds per square inch is shown at the bottom of each table, is limited to 2.6 million psi and less, and is applicable to all lumber sizes shown. Spans are shown in feet-inches and are limited to 26' and less. Check sources of supply for availability of lumber in lengths greater than 20'.

**TABLE R-3
RAFTERS WITH L/240 DEFLECTION LIMITATION**

DESIGN CRITERIA:

Strength – Live Load of 40 psf plus
Dead Load of 10 psf determines the required bending design value.
Deflection – For 40 psf live load.
Limited to span in inches divided by 240.

Size (in)	Spacing (in)	Rafters Design Value, F _b , (psi)																						
		300	400	500	600	700	800	900	1000	1100	1200	1300	1400	1500	1600	1700	1800	1900	2000	2100	2200	2300	2400	
2x6	12.0	5-6	6-4	7-1	7-9	8-5	9-0	9-6	10-0	10-6	11-0	11-5	11-11	12-4	12-8	13-1	13-6	13-10	14-2					
	16.0	4-9	5-6	6-2	6-9	7-3	7-9	8-3	8-8	9-1	9-6	9-11	10-3	10-8	11-0	11-4	11-8	12-0	12-4	12-7	12-11			
	19.2	4-4	5-0	5-7	6-2	6-8	7-1	7-6	7-11	8-4	8-8	9-1	9-5	9-9	10-0	10-4	10-8	10-11	11-3	11-6	11-9	12-0	12-4	
	24.0	3-11	4-6	5-0	5-6	5-11	6-4	6-9	7-1	7-5	7-9	8-1	8-5	8-8	9-0	9-3	9-6	9-9	10-0	10-3	10-6	10-9	11-0	
2x8	12.0	7-3	8-4	9-4	10-3	11-1	11-10	12-7	13-3	13-11	14-6	15-1	15-8	16-3	16-9	17-3	17-9	18-3	18-9					
	16.0	6-3	7-3	8-1	8-11	9-7	10-3	10-10	11-6	12-0	12-7	13-1	13-7	14-0	14-6	14-11	15-5	15-10	16-3	16-7	17-0			
	19.2	5-9	6-7	7-5	8-1	8-9	9-4	9-11	10-6	11-0	11-6	11-11	12-5	12-10	13-3	13-8	14-0	14-5	14-10	15-2	15-6	15-10	16-3	
	24.0	5-2	5-11	6-7	7-3	7-10	8-4	8-11	9-4	9-10	10-3	10-8	11-1	11-6	11-10	12-2	12-7	12-11	13-3	13-7	13-11	14-2	14-6	
2x10	12.0	9-3	10-8	11-11	13-1	14-2	15-1	16-0	16-11	17-9	18-6	19-3	20-0	20-8	21-4	22-0	22-8	23-3	23-11					
	16.0	8-0	9-3	10-4	11-4	12-3	13-1	13-10	14-8	15-4	16-0	16-8	17-4	17-11	18-6	19-1	19-7	20-2	20-8	21-2	21-8			
	19.2	7-4	8-5	9-5	10-4	11-2	11-11	12-8	13-4	14-0	14-8	15-3	15-10	16-4	16-11	17-5	17-11	18-5	18-11	19-4	19-10	20-3	20-8	
	24.0	6-6	7-7	8-5	9-3	10-0	10-8	11-4	11-11	12-6	13-1	13-7	14-2	14-8	15-1	15-7	16-0	16-6	16-11	17-4	17-9	18-1	18-6	
2x12	12.0	11-3	13-0	14-6	15-11	17-2	18-4	19-6	20-6	21-7	22-6	23-5	24-4	25-2	26-0									
	16.0	9-9	11-3	12-7	13-9	14-11	15-11	16-10	17-9	18-8	19-6	20-3	21-1	21-9	22-6	23-2	23-10	24-6	25-2	25-9				
	19.2	8-11	10-3	11-6	12-7	13-7	14-6	15-5	16-3	17-0	17-9	18-6	19-3	19-11	20-6	21-2	21-9	22-5	23-0	23-6	24-1	24-8	25-2	
	24.0	7-11	9-2	10-3	11-3	12-2	13-0	13-9	14-6	15-3	15-11	16-7	17-2	17-9	18-4	18-11	19-6	20-0	20-6	21-1	21-7	22-0	22-6	
E	12.0	0.14	0.22	0.31	0.41	0.51	0.63	0.75	0.88	1.01	1.15	1.30	1.45	1.61	1.77	1.94	2.12	2.30	2.48					
	16.0	0.12	0.19	0.27	0.35	0.44	0.54	0.65	0.76	0.88	1.00	1.12	1.26	1.39	1.54	1.68	1.83	1.99	2.15	2.31	2.48			
	19.2	0.11	0.18	0.24	0.32	0.41	0.50	0.59	0.69	0.80	0.91	1.03	1.15	1.27	1.40	1.54	1.67	1.81	1.96	2.11	2.26	2.42	2.58	
	24.0	0.10	0.16	0.22	0.29	0.36	0.44	0.53	0.62	0.71	0.81	0.92	1.03	1.14	1.25	1.37	1.50	1.62	1.75	1.89	2.02	2.16	2.30	

Note: The required modulus of elasticity, E, in 1,000,000 pounds per square inch is shown at the bottom of each table, is limited to 2.6 million psi and less, and is applicable to all lumber sizes shown. Spans are shown in feet-inches and are limited to 26' and less. Check sources of supply for availability of lumber in lengths greater than 20'.

**TABLE R-10
RAFTERS WITH L/240 DEFLECTION LIMITATION**

DESIGN CRITERIA:

Strength – Live Load of 30 psf plus Dead Load of 20 psf determines the required bending design value.
Deflection – For 30 psf live load.
Limited to span in inches divided by 240.

Size (in)	Rafters Bending Design Value, F _b , (psi)																									
	300	400	500	600	700	800	900	1000	1100	1200	1300	1400	1500	1600	1700	1800	1900	2000	2100	2200	2300	2400	2500	2600	2700	
12.0	5-6	6-4	7-1	7-9	8-5	9-0	9-6	10-0	10-0	10-5	10-10	10-10	11-3	11-7	11-11	12-4	12-8	13-0	13-3	13-7	13-11	14-2				
16.0	4-9	5-6	6-2	6-9	7-3	7-9	8-3	8-8	8-8	9-1	9-5	9-5	9-9	10-0	10-4	10-8	10-11	11-3	11-6	11-9	12-0	12-4	12-7	12-10	13-1	
2x6	19.2	4-4	5-0	5-7	6-2	6-8	7-1	7-6	7-11	7-7	8-3	8-7	8-11	9-2	9-5	9-9	10-0	10-3	10-6	10-9	11-0	11-3	11-5	11-8	11-11	
24.0	3-11	4-6	5-0	5-6	5-11	6-4	6-9	7-1	6-10	7-1	7-5	7-8	7-11	8-2	8-5	8-8	8-11	9-2	9-5	9-7	9-10	10-0	10-3	10-5	10-8	
12.0	7-3	8-4	9-4	10-3	11-1	11-10	12-7	13-3	12-8	13-3	13-9	14-4	14-10	15-3	15-9	16-3	16-8	17-1	17-6	17-11	18-4	18-9				
16.0	6-3	7-3	8-1	8-11	9-7	10-3	10-10	11-6	11-0	11-6	11-11	12-5	12-10	13-3	13-8	14-0	14-5	14-10	15-2	15-6	15-10	16-3	16-7	16-10	17-2	
2x8	19.2	5-9	6-7	7-5	8-1	8-9	9-4	9-11	10-6	10-0	10-11	11-4	11-8	12-1	12-5	12-10	13-2	13-6	13-10	14-2	14-6	14-10	15-1	15-5	15-8	
24.0	5-2	5-11	6-7	7-3	7-10	8-4	8-11	9-4	9-0	9-4	9-9	10-1	10-6	10-10	11-2	11-6	11-9	12-1	12-5	12-8	12-11	13-3	13-6	13-9	14-0	
12.0	9-3	10-8	11-11	13-1	14-2	15-1	16-0	16-11	16-2	16-11	17-7	18-3	18-11	19-6	20-1	20-8	21-3	21-10	22-4	22-10	23-5	23-11				
16.0	8-0	9-3	10-4	11-4	12-3	13-1	13-10	14-8	14-0	14-8	15-3	15-10	16-4	16-11	17-5	17-11	18-5	18-11	19-4	19-10	20-3	20-8	21-1	21-6	21-11	
2x10	19.2	7-4	8-5	9-5	10-4	11-2	11-11	12-8	13-4	12-9	13-4	13-11	14-5	14-11	15-5	15-11	16-4	16-10	17-3	17-8	18-1	18-6	18-11	19-3	19-8	20-0
24.0	6-6	7-7	8-5	9-3	10-0	10-8	11-4	11-11	11-5	11-11	12-5	12-11	13-4	13-9	14-3	14-8	15-0	15-5	15-10	16-2	16-6	16-1	17-3	17-7	17-11	
12.0	11-3	13-0	14-6	15-11	17-2	18-4	19-6	20-6	19-8	20-6	21-5	22-2	23-0	23-9	24-5	25-2	25-10									
16.0	9-9	11-3	12-7	13-9	14-11	15-11	16-10	17-9	17-0	17-9	18-6	19-3	19-11	20-6	21-2	21-9	22-5	23-0	23-6	24-1	24-8	25-2	25-8			
2x12	19.2	8-11	10-3	11-6	12-7	13-7	14-6	15-5	16-3	15-7	16-11	17-6	18-2	18-9	19-4	19-11	20-5	21-0	21-6	22-0	22-6	23-0	23-5	23-11	24-4	
24.0	7-11	9-2	10-3	11-3	12-2	13-0	13-9	14-6	13-11	14-6	15-1	15-8	16-3	16-9	17-3	17-9	18-3	18-9	19-3	19-8	20-1	20-6	21-0	21-5	21-9	
E	12.0	0.11	0.17	0.23	0.31	0.38	0.47	0.56	0.66	0.77	0.88	0.99	1.10	1.22	1.35	1.48	1.61	1.75	1.89	2.03	2.18	2.33	2.48			
E	16.0	0.09	0.14	0.20	0.26	0.33	0.41	0.49	0.57	0.67	0.76	0.86	0.96	1.06	1.17	1.28	1.39	1.51	1.63	1.76	1.88	2.01	2.15	2.28	2.42	2.56
E	19.2	0.09	0.13	0.18	0.24	0.30	0.37	0.44	0.52	0.61	0.69	0.78	0.87	0.97	1.07	1.17	1.27	1.38	1.49	1.60	1.72	1.84	1.96	2.08	2.21	2.34
E	24.0	0.08	0.12	0.16	0.22	0.27	0.33	0.40	0.46	0.54	0.62	0.70	0.78	0.87	0.95	1.04	1.14	1.23	1.33	1.43	1.54	1.64	1.75	1.86	1.98	2.09

Note: The required modulus of elasticity, E, in 1,000,000 pounds per square inch is shown at the bottom of each table, is limited to 2.6 million psi and less, and is applicable to all lumber sizes shown. Spans are shown in feet-inches and are limited to 26' and less. Check sources of supply for availability of lumber in lengths greater than 20'.

**TABLE R-11
RAFTERS WITH L/240 DEFLECTION LIMITATION**

DESIGN CRITERIA:

Strength – Live Load of 40 psf plus Dead Load of 20 psf determines the required bending design value.
Deflection – For 40 psf live load. Limited to span in inches divided by 240.

Size (in)	Rafters Bending Design Value, F _b , (psi)																									
	300	400	500	600	700	800	900	1000	1100	1200	1300	1400	1500	1600	1700	1800	1900	2000	2100	2200	2300	2400	2500	2600	2700	
12.0	5-0	5-10	6-6	7-1	7-8	8-2	8-8	9-2	10-6	11-0	11-5	11-11	12-4	12-8	13-1	13-6	13-10	14-2	14-7	14-11	15-3	15-7	15-11			
16.0	4-4	5-0	5-7	6-2	6-8	7-1	7-6	7-11	8-4	9-1	9-6	10-3	10-8	11-0	11-4	11-8	12-0	12-4	12-7	12-11	13-2	13-6	13-9	14-0	14-3	
2x6	19.2	4-0	4-7	5-1	5-7	6-1	6-6	7-3	8-4	8-8	9-1	9-5	9-9	10-0	10-4	10-8	10-11	11-3	11-6	11-9	12-0	12-4	12-7	12-10	13-1	
24.0	3-7	4-1	4-7	5-0	5-5	5-10	6-2	6-6	7-5	7-9	8-1	8-5	8-8	9-0	9-3	9-6	9-9	10-0	10-3	10-6	10-9	11-0	11-3	11-8		
12.0	6-7	7-8	8-7	9-4	10-1	10-10	11-6	12-1	13-11	14-6	15-1	15-8	16-3	16-9	17-3	17-9	18-3	18-9	19-2	19-8	20-1	20-6	20-11			
16.0	5-9	6-7	7-5	8-1	8-9	9-4	9-11	10-6	12-0	12-7	13-1	13-7	14-0	14-6	14-11	15-5	15-10	16-3	16-7	17-0	17-5	17-9	18-1	18-6	18-10	
2x8	19.2	5-3	6-0	6-9	7-5	8-0	8-7	9-1	9-7	11-0	11-6	11-11	12-5	12-10	13-3	14-0	14-5	14-10	15-2	15-6	15-10	16-3	16-7	16-10	17-2	
24.0	4-8	5-5	6-0	6-7	7-2	7-9	8-1	8-7	9-10	10-3	10-8	11-1	11-6	11-10	12-2	12-7	12-11	13-3	13-7	13-11	14-2	14-6	14-10	15-1	15-5	
12.0	8-5	9-9	10-11	11-11	12-11	13-9	14-8	15-5	17-9	18-6	19-3	20-0	20-8	21-4	22-0	22-8	23-3	23-11	24-6	25-1	25-7					
16.0	7-4	8-5	9-5	10-4	11-2	11-11	12-8	13-4	15-4	16-0	16-8	17-4	17-11	18-6	19-1	19-7	20-2	20-8	21-2	21-8	22-2	22-8	23-1	23-7	24-0	
2x10	19.2	6-8	7-8	8-7	9-5	10-2	10-11	11-7	12-2	14-0	14-8	15-3	15-10	16-4	16-11	17-5	18-5	18-11	19-4	19-10	20-3	20-8	21-1	21-6	21-11	
24.0	6-0	6-11	7-8	8-5	9-1	9-9	10-4	10-11	12-6	13-1	13-7	14-2	14-8	15-1	15-7	16-0	16-6	16-11	17-4	17-9	18-1	18-6	18-11	19-3	19-7	
12.0	10-3	11-10	13-3	14-6	15-8	16-9	17-9	18-9	21-7	22-6	23-5	24-4	25-2	26-0												
16.0	8-11	10-3	11-6	12-7	13-7	14-6	15-5	16-3	18-8	19-6	20-3	21-1	21-9	22-6	23-2	23-10	24-6	25-2	25-9							
2x12	19.2	8-1	9-4	10-6	11-6	12-5	13-3	14-1	14-10	17-0	17-9	18-6	19-3	19-11	20-6	21-2	21-9	22-5	23-0	23-6	24-1	25-2	25-8			
24.0	7-3	8-5	9-4	10-3	11-1	11-10	12-7	13-3	15-3	15-11	16-7	17-2	17-9	18-4	18-11	19-6	20-0	20-6	21-1	21-7	22-0	22-6	23-0	23-5	23-10	
E	12.0	0.11	0.17	0.24	0.31	0.39	0.48	0.57	0.67	0.76	0.86	0.97	1.09	1.21	1.33	1.46	1.59	1.72	1.86	2.00	2.14	2.29	2.44	2.60		
E	16.0	0.09	0.15	0.20	0.27	0.34	0.41	0.49	0.58	0.66	0.75	0.84	0.94	1.05	1.15	1.26	1.37	1.49	1.61	1.73	1.86	1.99	2.12	2.25	2.39	2.53
E	19.2	0.09	0.13	0.19	0.24	0.31	0.38	0.45	0.53	0.60	0.68	0.77	0.86	0.95	1.05	1.15	1.25	1.36	1.47	1.58	1.70	1.81	1.93	2.05	2.18	2.31
E	24.0	0.08	0.12	0.17	0.22	0.28	0.34	0.40	0.47	0.54	0.61	0.69	0.77	0.85	0.94	1.03	1.12	1.22	1.31	1.41	1.52	1.62	1.73	1.84	1.95	2.06

Note: The required modulus of elasticity, E, in 1,000,000 pounds per square inch is shown at the bottom of each table, is limited to 2.6 million psi and less, and is applicable to all lumber sizes shown. Spans are shown in feet-inches and are limited to 26' and less. Check sources of supply for availability of lumber in lengths greater than 20'.

**TABLE R-14
RAFTERS WITH L/180 DEFLECTION LIMITATION**

DESIGN CRITERIA:

Strength – Live Load of 30 psf plus Dead Load of 10 psf determines the required bending design value.
Deflection – For 30 psf live load. Limited to span in inches divided by 180.

Size (in)	Rafters Bending Design Value, F _b , (psi)																														
	200	300	400	500	600	700	800	900	1000	1100	1200	1300	1400	1500	1600	1700	1800	1900	2000	2100	2200	2300	2400	2500	2600	2700	2800	2900	3000		
12.0	3-2	3-11	4-6	5-1	5-6	6-0	6-5	6-9	7-2	7-6	7-10	8-2	8-5	8-9	9-0	9-4	9-7	9-10	10-1	10-4	10-10	10-10	11-1								
16.0	2-9	3-5	3-11	4-4	4-10	5-2	5-6	5-10	6-2	6-6	6-9	7-1	7-4	7-7	7-10	8-1	8-10	8-6	8-9	9-0	9-4	9-5	9-7	9-9	10-0						
2x4	2-6	3-1	3-7	4-0	4-4	4-9	5-1	5-4	5-8	5-11	6-2	6-5	6-8	6-11	7-2	7-4	7-7	7-9	8-0	8-2	8-2	8-7	8-9	8-11	9-1	9-3	9-5				
2x6	2-3	2-9	3-2	3-7	3-11	4-3	4-6	4-10	5-1	5-4	5-6	5-9	6-0	6-2	6-5	6-7	6-9	7-0	7-2	7-4	7-4	7-8	7-10	8-0	8-2	8-4	8-5	8-7	8-9		
12.0	5-0	6-2	7-1	7-11	8-8	9-5	10-0	10-8	11-3	11-9	12-4	12-10	13-3	13-9	14-2	14-8	15-1	15-6	15-11	16-3	16-3	17-0	17-5								
16.0	4-4	5-4	6-2	6-10	7-6	8-2	8-8	9-3	9-9	10-2	10-8	11-1	11-6	11-11	12-4	12-8	13-1	13-5	13-9	14-1	13-2	14-9	15-1	15-4	15-8						
2x6	4-0	4-10	5-7	6-3	6-10	7-5	7-11	8-5	8-11	9-4	9-9	10-1	10-6	10-10	11-3	11-7	11-11	12-3	12-7	12-10	12-0	13-6	13-9	14-0	14-4	14-7	14-10				
2x8	3-7	4-4	5-0	5-7	6-2	6-8	7-1	7-6	7-11	8-4	8-8	9-1	9-5	9-9	10-0	10-4	10-8	10-11	11-3	11-6	10-9	12-0	12-4	12-7	12-10	13-1	13-3	13-6	13-9		
12.0	6-7	8-1	9-4	10-6	11-6	12-5	13-3	14-0	14-10	15-6	16-3	16-10	17-6	18-1	18-9	19-4	19-10	20-5	20-11	21-5	20-1	22-5									
16.0	5-9	7-0	8-1	9-1	9-11	10-9	11-6	12-2	12-10	13-5	14-0	14-7	15-2	15-8	16-3	16-9	17-2	17-8	18-1	18-7	17-5	19-5	19-10	20-3	20-8						
2x8	5-3	6-5	7-5	8-3	9-1	9-9	10-6	11-1	11-8	12-3	12-10	13-4	13-10	14-4	14-10	15-3	15-8	16-2	16-7	17-1	15-10	17-9	18-1	18-6	18-10	19-3	19-7				
2x10	4-8	5-9	6-7	7-5	8-1	8-9	9-4	9-11	10-6	11-0	11-6	11-11	12-5	12-10	13-3	13-8	14-0	14-5	14-10	15-2	14-2	15-10	16-3	16-7	16-10	17-2	17-6	17-10	18-1		
12.0	8-5	10-4	11-11	13-4	14-8	15-10	16-11	17-11	18-11	19-10	20-8	21-6	22-4	23-1	23-11	24-7	25-4	26-0													
16.0	7-4	8-11	10-4	11-7	12-8	13-8	14-8	15-6	16-4	17-2	17-11	18-8	19-4	20-0	20-8	21-4	21-11	22-6	23-1	23-8	22-2	24-10	25-4	25-10							
2x10	6-8	8-2	9-5	10-7	11-7	12-6	13-4	14-2	14-11	15-8	16-4	17-0	17-8	18-3	18-11	19-6	20-0	20-7	21-1	21-8	20-3	22-8	23-1	23-7	24-1	24-6	25-0				
2x10	6-0	7-4	8-5	9-5	10-4	11-2	11-11	12-8	13-4	14-0	14-8	15-3	15-10	16-4	16-11	17-5	17-11	18-5	18-11	19-4	18-1	20-3	20-8	21-1	21-6	21-11	22-4	22-9	23-1		
E	12.0	0.06	0.11	0.17	0.24	0.32	0.40	0.49	0.59	0.69	0.79	0.91	1.02	1.14	1.27	1.39	1.53	1.66	1.80	1.95	2.10	2.29	2.40	2.56							
E	16.0	0.05	0.10	0.15	0.21	0.28	0.35	0.43	0.51	0.60	0.69	0.78	0.88	0.99	1.10	1.21	1.32	1.44	1.56	1.69	1.82	1.99	2.08	2.22	2.36	2.50					
E	19.2	0.05	0.08	0.12	0.19	0.25	0.32	0.39	0.47	0.54	0.63	0.72	0.81	0.90	1.00	1.10	1.21	1.32	1.43	1.54	1.66	1.78	1.90	2.03	2.15	2.28	2.42	2.55			
E	24.0	0.04	0.08	0.12	0.17	0.23	0.29	0.35	0.42	0.49	0.56	0.64	0.72	0.81	0.89	0.99	1.08	1.18	1.28	1.38	1.48	1.59	1.70	1.81	1.93	2.04	2.16	2.28	2.41	2.53	

Note: The required modulus of elasticity, E, in 1,000,000 pounds per square inch is shown at the bottom of each table, is limited to 2.6 million psi and less, and is applicable to all lumber sizes shown. Spans are shown in feet-inches and are limited to 26' and less. Check sources of supply for availability of lumber in lengths greater than 20'.

**TABLE R-15
RAFTERS WITH L/180 DEFLECTION LIMITATION**

DESIGN CRITERIA:

Strength – Live Load of 40 psf plus
Dead Load of 10 psf determines the required bending design value.
Deflection – For 40 psf live load.
Limited to span in inches divided by 180.

Size (in)	Rafters Bending Design Value, F _b , (psi)																													
	200	300	400	500	600	700	800	900	1000	1100	1200	1300	1400	1500	1600	1700	1800	1900	2000	2100	2200	2300	2400	2500	2600	2700	2800	2900	3000	
12.0	2-10	3-6	4-0	4-6	4-11	5-4	5-9	6-1	6-5	6-8	7-0	7-3	7-7	7-10	8-1	8-4	8-7	8-10	9-1	9-3	9-6	9-8	9-11	10-1						
16.0	2-6	3-0	3-6	3-11	4-3	4-8	4-11	5-3	5-6	5-10	6-1	6-4	6-7	6-9	7-0	7-3	7-5	7-8	7-10	8-0	8-2	8-5	8-7	8-9	8-11	9-1				
2x4	2-3	2-9	3-2	3-7	3-11	4-3	4-6	4-10	5-1	5-4	5-6	5-9	6-0	6-2	6-5	6-7	6-9	7-0	7-2	7-4	7-6	7-8	7-10	8-0	8-2	8-4	8-5	8-7		
2x10	2-0	2-6	2-10	3-2	3-6	3-9	4-0	4-3	4-6	4-9	4-11	5-2	5-4	5-6	5-9	5-11	6-1	6-3	6-5	6-7	6-8	6-10	7-0	7-2	7-3	7-5	7-7	7-8	7-10	
12.0	4-6	5-6	6-4	7-1	7-9	8-5	9-0	9-6	10-0	10-6	11-0	11-5	11-11	12-4	12-8	13-1	13-6	13-10	14-2	14-7	14-11	15-3	15-7	15-11						
16.0	3-11	4-9	5-6	6-2	6-9	7-3	7-9	8-3	8-8	9-1	9-6	9-11	10-3	10-8	11-0	11-4	11-8	12-0	12-4	12-7	12-11	13-2	13-6	13-9	14-0	14-3				
2x6	3-7	4-4	5-0	5-7	6-2	6-8	7-1	7-6	7-11	8-4	8-8	9-1	9-5	9-9	10-4	10-4	10-8	10-11	11-3	11-6	11-9	12-0	12-4	12-7	12-10	13-1	13-3	13-6		
2x10	3-2	3-11	4-6	5-0	5-6	5-11	6-4	6-9	7-1	7-5	7-9	8-1	8-5	8-8	9-0	9-3	9-6	9-9	10-2	10-3	10-6	10-9	11-0	11-3	11-5	11-8	11-11	12-1		
12.0	5-11	7-3	8-4	9-4	10-3	11-1	11-10	12-7	13-3	13-11	14-6	15-1	15-8	16-3	16-9	17-3	17-9	18-3	18-9	19-2	19-8	20-1	20-6	20-11						
16.0	5-2	6-3	7-3	8-1	8-11	9-7	10-3	10-10	11-6	12-0	12-7	13-1	13-7	14-0	14-6	14-11	15-5	15-10	16-3	16-7	17-0	17-5	17-9	18-1	18-6	18-10				
2x8	4-8	5-9	6-7	7-5	8-1	8-9	9-4	9-11	10-6	11-0	11-6	11-11	12-5	12-10	13-3	13-8	14-0	14-5	14-10	15-2	15-6	15-10	16-3	16-7	16-10	17-2	17-6	17-10		
2x10	4-2	5-2	5-11	6-7	7-3	7-10	8-4	8-11	9-4	9-10	10-3	10-8	11-1	11-6	11-10	12-2	12-7	12-11	13-3	13-7	13-11	14-2	14-6	14-10	15-1	15-5	15-8	15-11	16-3	
12.0	7-7	9-3	10-8	11-11	13-1	14-2	15-1	16-0	16-11	17-9	18-6	19-3	20-0	20-8	21-4	22-0	22-8	23-3	23-11	24-6	25-1	25-7								
16.0	6-6	8-0	9-3	10-4	11-4	12-3	13-1	13-10	14-8	15-4	16-0	16-8	17-4	17-11	18-6	19-1	19-7	20-2	20-8	21-2	21-8	22-2	22-8	23-1	23-7	24-0				
2x10	6-0	7-4	8-5	9-5	10-4	11-2	11-11	12-8	13-4	14-0	14-8	15-3	15-10	16-4	16-11	17-5	17-11	18-5	18-11	19-4	19-10	20-3	20-8	21-1	21-6	21-11	22-4	22-9		
2x10	5-4	6-6	7-7	8-5	9-3	10-0	10-8	11-4	11-11	12-6	13-1	13-7	14-2	14-8	15-1	15-7	16-0	16-6	16-11	17-4	17-9	18-1	18-6	18-11	19-3	19-7	20-0	20-4	20-8	
E	12.0	0.06	0.11	0.17	0.23	0.31	0.38	0.47	0.56	0.66	0.76	0.86	0.97	1.09	1.21	1.33	1.46	1.59	1.72	1.86	2.00	2.14	2.29	2.44	2.60					
E	16.0	0.05	0.09	0.14	0.20	0.26	0.33	0.41	0.49	0.57	0.66	0.75	0.84	0.94	1.06	1.15	1.26	1.37	1.49	1.61	1.73	1.86	1.99	2.12	2.25	2.39	2.53			
E	19.2	0.05	0.09	0.13	0.18	0.24	0.30	0.37	0.44	0.52	0.60	0.68	0.77	0.86	0.96	1.05	1.15	1.25	1.36	1.47	1.58	1.70	1.81	1.93	2.05	2.18	2.31	2.43	2.57	
E	24.0	0.04	0.08	0.12	0.16	0.22	0.27	0.33	0.40	0.46	0.54	0.61	0.69	0.77	0.85	0.94	1.03	1.12	1.22	1.31	1.41	1.52	1.62	1.73	1.84	1.95	2.06	2.18	2.30	2.41

Note: The required modulus of elasticity, E, in 1,000,000 pounds per square inch is shown at the bottom of each table, is limited to 2.6 million psi and less, and is applicable to all lumber sizes shown. Spans are shown in feet-inches and are limited to 26' and less. Check sources of supply for availability of lumber in lengths greater than 20'.

**TABLE R-22
RAFTERS WITH L/180 DEFLECTION LIMITATION**

DESIGN CRITERIA:

Strength – Live Load of 30 psf plus Dead Load of 20 psf determines the required bending design value.
Deflection – For 30 psf live load. Limited to span in inches divided by 180.

Size (in)	Rafters Bending Design Value, F _b , (psi)																													
	200	300	400	500	600	700	800	900	1000	1100	1200	1300	1400	1500	1600	1700	1800	1900	2000	2100	2200	2300	2400	2500	2600	2700	2800	2900	3000	
12.0	2-10	3-6	4-0	4-6	4-11	5-4	5-9	6-1	6-5	6-8	7-0	7-3	7-7	7-10	8-1	8-4	8-7	8-10	9-0	9-3	9-6	9-8	9-8	9-11	10-1	10-4	10-6	10-8	10-11	11-1
16.0	2-6	3-0	3-6	3-11	4-3	4-8	4-11	5-3	5-6	5-10	6-1	6-4	6-7	6-9	7-0	7-3	7-5	7-8	7-10	8-0	8-2	8-5	8-7	8-9	8-11	9-1	9-3	9-5	9-7	9-9
2x4	19.2	2-3	2-9	3-2	3-7	3-11	4-3	4-6	4-10	5-1	5-4	5-6	5-9	6-0	6-2	6-5	6-7	6-9	7-0	7-2	7-4	7-6	7-8	7-10	8-0	8-2	8-4	8-5	8-7	8-9
2x10	2-0	2-6	2-10	3-2	3-6	3-9	4-0	4-3	4-6	4-9	4-11	5-2	5-4	5-6	5-9	5-11	6-1	6-3	6-5	6-7	6-8	6-10	7-0	7-2	7-3	7-5	7-7	7-8	7-10	
12.0	4-6	5-6	6-4	7-1	7-9	8-5	9-0	9-6	10-0	10-6	11-0	11-5	11-11	12-4	12-8	13-1	13-6	13-10	14-2	14-7	14-11	15-3	15-7	15-11	16-2	16-6	16-10	17-1	17-5	
16.0	3-11	4-9	5-6	6-2	6-9	7-3	7-9	8-3	8-8	9-1	9-6	9-11	10-3	10-8	11-0	11-4	11-8	12-0	12-4	12-7	12-11	13-2	13-6	13-9	14-0	14-3	14-7	14-10	15-1	
2x6	19.2	3-7	4-4	5-0	5-7	6-2	6-8	7-1	7-6	7-11	8-4	8-8	9-1	9-5	9-9	10-4	10-8	10-11	11-3	11-6	11-9	12-0	12-4	12-7	12-10	13-1	13-3	13-6	13-9	
2x10	3-2	3-11	4-6	5-0	5-6	5-11	6-4	6-9	7-1	7-5	7-9	8-1	8-5	8-8	9-0	9-3	9-6	9-9	10-2	10-3	10-6	10-9	11-0	11-3	11-5	11-8	11-11	12-1	12-4	
12.0	5-11	7-3	8-4	9-4	10-3	11-1	11-10	12-7	13-3	13-11	14-6	15-1	15-8	16-3	16-9	17-3	17-9	18-3	18-9	19-2	19-8	20-1	20-6	20-11	21-4	21-9	22-2	22-6	22-11	
16.0	5-2	6-3	7-3	8-1	8-11	9-7	10-3	10-10	11-6	12-0	12-7	13-1	13-7	14-0	14-6	14-11	15-5	15-10	16-3	16-7	17-0	17-5	17-9	18-1	18-6	18-10	19-2	19-6	19-10	
2x8	19.2	4-8	5-9	6-7	7-5	8-1	8-9	9-4	9-11	10-6	11-0	11-6	12-5	12-10	13-3	13-8	14-0	14-5	14-10	15-2	15-6	15-10	16-3	16-7	16-10	17-2	17-6	17-10	18-1	
2x10	4-2	5-2	5-11	6-7	7-3	7-10	8-4	8-11	9-4	9-10	10-3	10-8	11-1	11-6	11-10	12-2	12-7	12-11	13-3	13-7	13-11	14-2	14-6	14-10	15-1	15-5	15-8	15-11	16-3	
12.0	7-7	9-3	10-8	11-11	13-1	14-2	15-1	16-0	16-11	17-9	18-6	19-3	20-0	20-8	21-4	22-0	22-8	23-3	23-11	24-6	25-1	25-7								
16.0	6-6	8-0	9-3	10-4	11-4	12-3	13-1	13-10	14-8	15-4	16-0	16-8	17-4	17-11	18-6	19-1	19-7	20-2	20-8	21-2	21-8	22-2	22-8	23-1	23-7	24-0	24-6	24-11	25-4	
2x10	19.2	6-0	7-4	8-5	9-5	10-4	11-2	11-11	12-8	13-4	14-0	14-8	15-10	16-4	16-11	17-5	17-11	18-5	18-11	19-4	19-10	20-3	20-8	21-1	21-6	21-11	22-4	22-9	23-1	
2x10	5-4	6-6	7-7	8-5	9-3	10-0	10-8	11-4	11-11	12-6	13-1	13-7	14-2	14-8	15-1	15-7	16-0	16-6	16-11	17-4	17-9	18-1	18-6	18-11	19-3	19-7	20-0	20-4	20-8	
E	12.0	0.04	0.08	0.12	0.17	0.23	0.29	0.35	0.42	0.49	0.57	0.65	0.73	0.82	0.91	1.00	1.09	1.19	1.29	1.39	1.50	1.61	1.72	1.83	1.95	2.07	2.19	2.31	2.43	2.56
E	16.0	0.04	0.07	0.11	0.15	0.20	0.25	0.31	0.36	0.43	0.49	0.56	0.63	0.71	0.78	0.86	0.95	1.03	1.12	1.21	1.30	1.39	1.49	1.59	1.69	1.79	1.89	2.00	2.11	2.22
E	19.2	0.03	0.06	0.10	0.14	0.18	0.23	0.28	0.33	0.39	0.45	0.51	0.58	0.65	0.72	0.79	0.86	0.94	1.02	1.10	1.19	1.27	1.36	1.45	1.54	1.63	1.73	1.83	1.92	2.03
E	24.0	0.03	0.06	0.09	0.12	0.16	0.20	0.25	0.30	0.35	0.40	0.46	0.52	0.58	0.64	0.71	0.77	0.84	0.91	0.99	1.06	1.14	1.22	1.30	1.38	1.46	1.55	1.63	1.72	1.81

Note: The required modulus of elasticity, E, in 1,000,000 pounds per square inch is shown at the bottom of each table, is limited to 2.6 million psi and less, and is applicable to all lumber sizes shown. Spans are shown in feet-inches and are limited to 26' and less. Check sources of supply for availability of lumber in lengths greater than 20'.

**TABLE R-23
RAFTERS WITH L/180 DEFLECTION LIMITATION**

DESIGN CRITERIA:

Strength – Live Load of 40 psf plus Dead Load of 20 psf determines the required bending design value.
Deflection – For 40 psf live load. Limited to span in inches divided by 180.

Size (in)	Rafters Bending Design Value, F _b , (psi)																													
	200	300	400	500	600	700	800	900	1000	1100	1200	1300	1400	1500	1600	1700	1800	1900	2000	2100	2200	2300	2400	2500	2600	2700	2800	2900	3000	
12.0	2-7	3-2	3-8	4-1	4-6	4-11	5-3	5-6	5-10	6-1	6-5	6-8	6-11	7-2	7-5	7-7	7-10	8-0	8-3	8-5	8-8	8-10	9-0	9-3	9-5	9-7	9-9	9-11	10-1	
16.0	2-3	2-9	3-2	3-7	3-11	4-3	4-6	4-10	5-1	5-4	5-6	5-9	6-0	6-2	6-5	6-7	6-9	7-0	7-2	7-4	7-6	7-8	7-10	8-0	8-2	8-4	8-5	8-7	8-9	
2x4	2-1	2-6	2-11	3-3	3-7	3-10	4-1	4-4	4-7	4-10	5-1	5-3	5-5	5-8	5-10	6-0	6-2	6-4	6-6	6-8	6-10	7-0	7-2	7-3	7-5	7-7	7-9	7-10	8-0	
2x6	1-10	2-3	2-7	2-11	3-2	3-5	3-8	3-11	4-1	4-4	4-6	4-8	4-11	5-1	5-3	5-5	5-6	5-8	5-10	6-0	6-1	6-3	6-5	6-6	6-8	6-9	6-11	7-0	7-2	
12.0	4-1	5-0	5-10	6-6	7-1	7-8	8-2	8-8	9-2	9-7	10-0	10-5	10-10	11-3	11-7	11-11	12-4	12-8	13-0	13-3	13-7	13-11	14-2	14-6	14-9	15-1	15-4	15-7	15-11	
16.0	3-7	4-4	5-0	5-7	6-2	6-8	7-1	7-6	7-11	8-4	8-8	9-1	9-5	9-9	10-0	10-4	10-8	10-11	11-3	11-6	11-9	12-0	12-4	12-7	12-10	13-1	13-3	13-6	13-9	
2x6	3-3	4-0	4-7	5-1	5-7	6-1	6-6	6-10	7-3	7-7	7-11	8-3	8-7	8-11	9-2	9-5	9-9	10-0	10-3	10-6	10-9	11-0	11-3	11-5	11-8	11-11	12-2	12-4	12-7	
2x8	2-11	3-7	4-1	4-7	5-0	5-5	5-10	6-2	6-6	6-10	7-1	7-5	7-8	7-11	8-2	8-5	8-8	8-11	9-2	9-5	9-7	9-10	10-0	10-3	10-5	10-8	10-10	11-0	11-3	
12.0	5-5	6-7	7-8	8-7	9-4	10-1	10-10	11-6	12-1	12-8	13-3	13-9	14-4	14-10	15-3	15-9	16-3	16-8	17-1	17-6	17-11	18-4	18-9	19-1	19-6	19-10	20-3	20-7	20-11	
16.0	4-8	5-9	6-7	7-5	8-1	8-9	9-4	9-11	10-6	11-0	11-6	11-11	12-5	12-10	13-3	13-8	14-0	14-5	14-10	15-2	15-6	15-10	16-3	16-7	16-10	17-2	17-6	17-10	18-1	
2x8	4-3	5-3	6-0	6-9	7-5	8-0	8-7	9-1	9-7	10-0	10-6	10-11	11-4	11-8	12-1	12-5	12-10	13-2	13-6	13-10	14-2	14-6	14-10	15-1	15-5	15-8	16-0	16-3	16-7	
2x10	3-10	4-8	5-5	6-0	6-7	7-2	7-8	8-1	8-7	9-0	9-4	9-9	10-1	10-6	10-10	11-2	11-6	11-9	12-1	12-5	12-8	12-11	13-3	13-6	13-9	14-0	14-4	14-7	14-10	
12.0	6-11	8-5	9-9	10-11	11-11	12-11	13-9	14-8	15-5	16-2	16-11	17-7	18-3	18-11	19-6	20-1	20-8	21-3	21-10	22-4	22-10	23-5	23-11	24-5	24-10	25-4	25-10			
16.0	6-0	7-4	8-5	9-5	10-4	11-2	11-11	12-8	13-4	14-0	14-8	15-3	15-10	16-4	16-11	17-5	17-11	18-5	18-11	19-4	19-10	20-3	20-8	21-1	21-6	21-11	22-4	22-9	23-1	
2x10	5-5	6-8	7-8	8-7	9-5	10-2	10-11	11-7	12-2	12-9	13-4	13-11	14-5	14-11	15-5	15-11	16-4	16-10	17-3	17-8	18-1	18-6	18-11	19-3	19-8	20-0	20-5	20-9	21-1	
2x12	4-11	6-0	6-11	7-8	8-5	9-1	9-9	10-4	10-11	11-5	11-11	12-5	12-11	13-4	13-9	14-3	14-8	15-0	15-5	15-10	16-2	16-6	16-11	17-3	17-7	17-11	18-3	18-7	18-11	
E	12.0	0.04	0.08	0.13	0.18	0.23	0.29	0.36	0.43	0.50	0.58	0.66	0.74	0.83	0.92	1.01	1.11	1.21	1.31	1.41	1.52	1.63	1.74	1.86	1.98	2.10	2.22	2.34	2.47	2.60
E	16.0	0.04	0.07	0.11	0.15	0.20	0.25	0.31	0.37	0.43	0.50	0.57	0.64	0.72	0.80	0.88	0.96	1.05	1.13	1.22	1.32	1.41	1.51	1.61	1.71	1.82	1.92	2.03	2.14	2.25
E	19.2	0.04	0.06	0.10	0.14	0.18	0.23	0.28	0.34	0.40	0.46	0.52	0.59	0.65	0.73	0.80	0.88	0.95	1.04	1.12	1.20	1.29	1.38	1.47	1.56	1.66	1.75	1.85	1.95	2.05
E	24.0	0.03	0.06	0.09	0.13	0.16	0.21	0.25	0.30	0.35	0.41	0.46	0.52	0.59	0.65	0.72	0.78	0.85	0.93	1.00	1.08	1.15	1.23	1.31	1.40	1.48	1.57	1.66	1.75	1.84

Note: The required modulus of elasticity, E, in 1,000,000 pounds per square inch is shown at the bottom of each table, is limited to 2.6 million psi and less, and is applicable to all lumber sizes shown. Spans are shown in feet-inches and are limited to 26' and less. Check sources of supply for availability of lumber in lengths greater than 20'.

Design Values for Joists and Rafters

These "Fb" values are for use where repetitive members are spaced not more than 24 inches. Values for surfaced dry or surfaced green lumber apply at 19% maximum moisture content in use.

Species and Grade	Size	Design Value in Bending, "Fb"		Modulus of Elasticity "E"	Grading Rules Agency
		Normal Duration	Snow Loading		
Cottonwood					
Select Structural	2x4	1510	1735	1,200,000	NSLB
No.1		1080	1240	1,200,000	
No.2		1080	1240	1,100,000	
No.3		605	695	1,000,000	
Stud		600	690	1,000,000	
Construction		805	925	1,000,000	
Standard		460	530	900,000	
Utility		200	230	900,000	
Select Structural	2x6	1310	1505	1,200,000	
No.1		935	1075	1,200,000	
No.2		935	1075	1,100,000	
No.3		525	600	1,000,000	
Stud	545	630	1,000,000		
Select Structural	2x8	1210	1390	1,200,000	
No.1		865	990	1,200,000	
No.2		865	990	1,100,000	
No.3		485	555	1,000,000	
Select Structural	2x10	1105	1275	1,200,000	
No.1		790	910	1,200,000	
No.2		790	910	1,100,000	
No.3		445	510	1,000,000	
Select Structural	2x12	1005	1155	1,200,000	
No.1		720	825	1,200,000	
No.2		720	825	1,100,000	
No.3		405	465	1,000,000	
Douglas Fir-Larch					
Select Structural	2x4	2500	2875	1,900,000	WCLIB WWPA
No.1 & Btr		1985	2280	1,800,000	
No.1		1725	1985	1,700,000	
No.2		1510	1735	1,600,000	
No.3		865	990	1,400,000	
Stud		855	980	1,400,000	
Construction		1150	1325	1,500,000	
Standard		635	725	1,400,000	
Utility	315	365	1,300,000		
Select Structural	2x6	2170	2495	1,900,000	
No.1 & Btr		1720	1975	1,800,000	
No.1		1495	1720	1,700,000	
No.2		1310	1505	1,600,000	
No.3		750	860	1,400,000	
Stud	775	895	1,400,000		
Select Structural	2x8	2000	2300	1,900,000	
No.1 & Str		1585	1825	1,800,000	
No.1		1380	1585	1,700,000	
No.2		1210	1390	1,600,000	
No.3		690	795	1,400,000	
Select Structural	2x10	1835	2110	1,900,000	
No.1 & Btr		1455	1675	1,800,000	
No.1		1265	1455	1,700,000	
No.2		1105	1275	1,600,000	
No.3	635	725	1,400,000		
Select Structural	2x12	1670	1920	1,900,000	
No.1 & Btr		1325	1520	1,800,000	
No.1		1150	1325	1,700,000	
No.2		1005	1155	1,600,000	
No.3		575	660	1,400,000	

Comm 20-25 APPENDIX

WISCONSIN ADMINISTRATIVE CODE

Species and Grade	Size	Design Value in Bending, "Fb"		Modulus of Elasticity "E"	Grading Rules Agency
		Normal Duration	Snow Loading		
Douglas Fir-Larch (North)					
Select Structural	2x4	2245	2580	1,900,000	NLGA
No.1 /No.2		1425	1635	1,600,000	
No.3		820	940	1,400,000	
Stud		820	945	1,400,000	
Construction		1095	1255	1,500,000	
Standard		605	695	1,400,000	
Utility		290	330	1,300,000	
Select Structural	2x6	1945	2235	1,900,000	
No.1 /No.2		1235	1420	1,600,000	
No.3		710	815	1,400,000	
Stud	750	860	1,400,000		
Select Structural	2x8	1795	2065	1,900,000	
No.1 /No.2		1140	1310	1,600,000	
No.3		655	755	1,400,000	
Select Structural	2x10	1645	1890	1,900,000	
No.1 /No-2		1045	1200	1,600,000	
No.3		600	690	1,400,000	
Select Structural	2x12	1495	1720	1,900,000	
No.1 /No.2		950	1090	1,600,000	
No.3		545	630	1,400,000	
Douglas Fir-South					
Select Structural	2x4	2245	2580	1,400,000	WWPA
No.1		1555	1785	1,300,000	
No.2		1425	1635	1,200,000	
No.3		820	940	1,100,000	
Stud		820	945	1,100,000	
Construction		1065	1225	1,200,000	
Standard		605	695	1,100,000	
Utility	290	330	1,000,000		
Select Structural	2x6	1945	2235	1,400,000	
No.1		1345	1545	1,300,000	
No.2		1235	1420	1,200,000	
No.3		710	815	1,100,000	
Stud	750	860	1,100,000		
Select Structural	2x8	1795	2065	1,400,000	
No.1		1240	1430	1,300,000	
No.2		1140	1310	1,200,000	
No.3	655	755	1,100,000		
Select Structural	2x10	1645	1890	1,400,000	
No.1		1140	1310	1,300,000	
No.2		1045	1200	1,200,000	
No.3	600	690	1,100,000		
Select Structural	2x12	1495	1720	1,400,000	
No.1		1035	1190	1,300,000	
No.2		950	1090	1,200,000	
No.3	545	630	1,100,000		

Species and Grade	Size	Design Value in Bending, "Fb"		Modulus of Elasticity "E"	Grading Rules Agency
		Normal Duration	Snow Loading		
Eastern Hemlock-Tamarack					
Select Structural	2x4	2155	2480	1,200,000	NELMA NSLB
No.1		1335	1535	1,100,000	
No.2		990	1140	1,100,000	
No.3		605	695	900,000	
Stud		570	655	900,000	
Construction		775	895	1,000,000	
Standard		430	495	900,000	
Utility		200	230	800,000	
Select Structural	2x6	1870	2150	1,200,000	
No.1		1160	1330	1,100,000	
No.2		860	990	1,100,000	
No.3		525	600	900,000	
Stud	520	595	900,000		
Select Structural	2x8	1725	1985	1,200,000	
No.1		1070	1230	1,100,000	
No.2		795	915	1,100,000	
No.3		485	555	900,000	
Select Structural	2x10	1580	1820	1,200,000	
No.1		980	1125	1,100,000	
No.2		725	835	1,100,000	
No.3	445	510	900,000		
Select Structural	2x12	1440	1655	1,200,000	
No.1		890	1025	1,100,000	
No.2		660	760	1,100,000	
No.3		405	465	900,000	
Eastern Softwoods					
Select Structural	2x4	2155	2480	1,200,000	NELMA NSLB
No.1		1335	1535	1,100,000	
No.2		990	1140	1,100,000	
No.3		605	695	900,000	
Stud		570	655	900,000	
Construction		775	895	1,000,000	
Standard		430	495	900,000	
Utility		200	230	800,000	
Select Structural	2x6	1870	2150	1,200,000	
No.1		1160	1330	1,100,000	
No.2		860	990	1,100,000	
No.3		525	600	900,000	
Stud	520	595	900,000		
Select Structural	2x8	1725	1985	1,200,000	
No.1		1070	1230	1,100,000	
No.2		795	915	1,100,000	
No.3		485	555	900,000	
Select Structural	2x10	1580	1820	1,200,000	
No.1		980	1125	1,100,000	
No.2		725	835	1,100,000	
No.3	445	510	900,000		
Select Structural	2x12	1440	1655	1,200,000	
No.1		890	1025	1,100,000	
No.2		660	760	1,100,000	
No.3		405	465	900,000	

Comm 20-25 APPENDIX

WISCONSIN ADMINISTRATIVE CODE

Species and Grade	Size	Design Value in Bending, "Fb"		Modulus of Elasticity "E"	Grading Rules Agency
		Normal Duration	Snow Loading		
Eastern White Pine					
Select Structural	2x4	2155	2480	1,200,000	NELMA NSLB
No.1		1335	1535	1,100,000	
No.2		990	1140	1,100,000	
No.3		605	695	900,000	
Stud		570	655	900,000	
Construction		775	895	1,000,000	
Standard		430	495	900,000	
Utility		200	230	800,000	
Select Structural	2x6	1870	2150	1,200,000	
No.1		1160	1330	1,100,000	
No.2		860	990	1,100,000	
No.3		525	600	900,000	
Stud		520	595	900,000	
Select Structural	2x8	1725	1985	1,200,000	
No.1		1070	1230	1,100,000	
No.2		795	915	1,100,000	
No.3		485	555	900,000	
Select Structural	2x10	1580	1820	1,200,000	
No.1		980	1125	1,100,000	
No.2		725	835	1,100,000	
No.3	445	510	900,000		
Select Structural	2x12	1440	1655	1,200,000	
No.1		890	1025	1,100,000	
No.2		660	760	1,100,000	
No.3		405	465	900,000	
Hem Fir					
Select Structural	2x4	2415	2775	1,600,000	WCLIB WWPA
No.1 & Btr		1810	2085	1,500,000	
No.1		1640	1885	1,500,000	
No.2		1465	1685	1,300,000	
No.3		865	990	1,200,000	
Stud		855	980	1,200,000	
Construction		1120	1290	1,300,000	
Standard		635	725	1,200,000	
Utility		290	330	1,100,000	
Select Structural	2x6	2095	2405	1,600,000	
No.1 & Btr		1570	1805	1,500,000	
No.1		1420	1635	1,500,000	
No.2		1270	1460	1,300,000	
No.3		750	860	1,200,000	
Stud		775	895	1,200,000	
Select Structural	2x8	1930	2220	1,600,000	
No.1 & Btr		1450	1665	1,500,000	
No.1		1310	1510	1,500,000	
No.2		1175	1350	1,300,000	
No.3	690	795	1,200,000		
Select Structural	2x10	1770	2035	1,600,000	
No.1 & Btr		1330	1525	1,500,000	
No.1		1200	1380	1,500,000	
No.2		1075	1235	1,300,000	
No.3	635	725	1,200,000		
Select Structural	2x12	1610	1850	1,600,000	
No.1 & Btr		1210	1390	1,500,000	
No.1		1095	1255	1,500,000	
No.2		980	1125	1,300,000	
No.3		575	660	1,200,000	

Species and Grade	Size	Design Value in Bending, "Fb"		Modulus of Elasticity "E"	Grading Rules Agency
		Normal Duration	Snow Loading		
Hem-Fir (North)					
Select Structural	2x4	2245	2580	1,700,000	NLGA
No.1 /No.2		1725	1985	1,600,000	
No.3		990	1140	1,400,000	
Stud		980	1125	1,400,000	
Construction		1325	1520	1,500,000	
Standard		720	825	1,400,000	
Utility		345	395	1,300,000	
Select Structural	2x6	1945	2235	1,700,000	
No.1 /No.2		1495	1720	1,600,000	
No.3		860	990	1,400,000	
Stud	2x8	890	1025	1,400,000	
Select Structural		1795	2065	1,700,000	
No.1 /No.2		1380	1585	1,600,000	
No.3	2x10	795	915	1,400,000	
Select Structural		1645	1890	1,700,000	
No.1 /No.2		1265	1455	1,600,000	
No.3	2x12	725	835	1,400,000	
Select Structural		1495	1720	1,700,000	
No.1 /No.2		1150	1325	1,600,000	
No.3		660	760	1,400,000	
Mixed Maple					
Select Structural	2x4	1725	1985	1,300,000	NELMA
No.1		1250	1440	1,200,000	
No.2		1210	1390	1,100,000	
No.3		690	795	1,000,000	
Stud		695	Boo	1,000,000	
Construction		920	1060	1,100,000	
Standard		520	595	1,000,000	
Utility		260	300	900,000	
Select Structural	2x6	1495	1720	1,300,000	
No.1		1085	1245	1,200,000	
No.2		1045	1205	1,100,000	
No.3		600	690	1,000,000	
Stud		635	725	1,000,000	
Select Structural	2x8	1380	1585	1,300,000	
No.1		1000	1150	1,200,000	
No.2		965	1110	1,100,000	
No.3	2x10	550	635	1,000,000	
Select Structural		1265	1455	1,300,000	
No.1		915	1055	1,200,000	
No.2		885	1020	1,100,000	
No.3	2x12	505	580	1,000,000	
Select Structural		1150	1325	1,300,000	
No.1		835	960	1,200,000	
No.2		805	925	1,100,000	
No.3		460	530	1,000,000	

Comm 20-25 APPENDIX

WISCONSIN ADMINISTRATIVE CODE

Species and Grade	Size	Design Value in Bending, "Fb"		Modulus of Elasticity "E"	Grading Rules Agency
		Normal Duration	Snow Loading		
Mixed Oak					
Select Structural	2x4	1985	2280	1,100,000	NELMA
No.1		1425	1635	1,000,000	
No.2		1380	1585	900,000	
No.3		820	940	800,000	
Stud		790	910	800,000	
Construction		1065	1225	900,000	
Standard		605	695	800,000	
Utility		290	330	800,000	
Select Structural	2x6	1720	1975	1,100,000	
No.1		1235	1420	1,000,000	
No.2		1195	1375	900,000	
No.3		710	815	800,000	
Stud	720	825	800,000		
Select Structural	2x8	1585	1825	1,100,000	
No.1		1140	1310	1,000,000	
No.2		1105	1270	900,000	
No.3		655	755	800,000	
Select Structural	2x10	1455	1675	1,100,000	
No.1		1045	1200	1,000,000	
No.2		1010	1165	900,000	
No.3		600	690	800,000	
Select Structural	2x12	1325	1520	1,100,000	
No.1		950	1090	1,000,000	
No.2		920	1060	900,000	
No.3		545	630	800,000	
Mixed Southern Pine					
Select Structural	2x4	2360	2710	1,600,000	SPIB
No.1		1670	1920	1,500,000	
No.2		1500	1720	1,400,000	
No.3		865	990	1,200,000	
Stud		890	1020	1,200,000	
Construction		1150	1320	1,300,000	
Standard		635	725	1,200,000	
Utility		315	365	1,100,000	
Select Structural	2x6	2130	2450	1,600,000	
No.1		1490	1720	1,500,000	
No.2		1320	1520	1,400,000	
No.3		775	895	1,200,000	
Stud	775	895	1,200,000		
Select Structural	2x8	2010	2310	1,600,000	
No.1		1380	1590	1,500,000	
No.2		1210	1390	1,400,000	
No.3	720	825	1,200,000		
Select Structural	2x10	1730	1980	1,600,000	
No.1		1210	1390	1,500,000	
No.2		1060	1220	1,400,000	
No.3		605	695	1,200,000	
Select Structural	2x12	1610	1850	1,600,000	
No.1		1120	1290	1,500,000	
No.2		1010	1160	1,400,000	
No.3		575	660	1,200,000	

Species and Grade	Size	Design Value in Bending, "Fb"		Modulus of Elasticity "E"	Grading Rules Agency
		Normal Duration	Snow Loading		
Northern Red Oak					
Select Structural	2x4	2415	2775	1,400,000	NELMA
No.1		1725	1985	1,400,000	
No.2		1680	1935	1,300,000	
No.3		950	1090	1,200,000	
Stud		950	1090	1,200,000	
Construction		1265	1455	1,200,000	
Standard		720	825	1,100,000	
Utility		345	395	1,000,000	
Select Structural	2x6	2095	2405	1,400,000	
No.1		1495	1720	1,400,000	
No.2		1460	1675	1,300,000	
No.3		820	945	1,200,000	
Stud	865	990	1,200,000		
Select Structural	2x8	1930	2220	1,400,000	
No.1		1380	1585	1,400,000	
No.2		1345	1545	1,300,000	
No.3		760	875	1,200,000	
Select Structural	2x10	1770	2035	1,400,000	
No.1		1265	1455	1,400,000	
No.2		1235	1420	1,300,000	
No.3	695	800	1,200,000		
Select Structural	2x12	1610	1850	1,400,000	
No.1		1150	1325	1,400,000	
No.2		1120	1290	1,300,000	
No.3		635	725	1,200,000	
Northern Species					
Select Structural	2x4	1640	1885	1,100,000	NLGA
No.1 /No.2		990	1140	1,100,000	
No.3		605	695	1,000,000	
Stud		570	655	1,000,000	
Construction		775	895	1,000,000	
Standard		430	495	900,000	
Utility		200	230	900,000	
Select Structural		2x6	1420	1635	
No. 1 / No.2	860		990	1,100,000	
No.3	525		600	1,000,000	
Stud	520		595	1,000,000	
Select Structural	2x8	1310	1510	1,100,000	
No.1/No.2		795	915	1,100,000	
No.3		485	555	1,000,000	
Select Structural	2x10	1200	1380	1,100,000	
No.1 /No.2		725	835	1,100,000	
No.3		445	510	1,000,000	
Select Structural	2x12	1095	1255	1,100,000	
No.1 /No.2		660	760	1,100,000	
No.3		405	465	1,000,000	

Species and Grade	Size	Design Value in Bending, "Fb"		Modulus of Elasticity "E"	Grading Rules Agency
		Normal Duration	Snow Loading		
Northern White Cedar					
Select Structural	2x4	1335	1535	800,000	NELMA
No.1		990	1140	700,000	
No.2		950	1090	700,000	
No.3		560	645	600,000	
Stud		540	620	600,000	
Construction		720	825	700,000	
Standard		405	465	600,000	
Utility		200	230	600,000	
Select Structural	2x6	1160	1330	800,000	
No.1		860	990	700,000	
No.2		820	945	700,000	
No.3		485	560	600,000	
Stud	490	560	600,000		
Select Structural	2x8	1070	1230	800,000	
No.1		795	915	700,000	
No.2		760	875	700,000	
No.3		450	515	600,000	
Select Structural	2x10	980	1125	800,000	
No.1		725	835	700,000	
No.2		695	800	700,000	
No.3		410	475	600,000	
Select Structural	2x12	890	1025	800,000	
No.1		660	760	700,000	
No.2		635	725	700,000	
No.3		375	430	600,000	
Red Maple					
Select Structural	2x4	2245	2580	1,700,000	NELMA
No.1		1595	1835	1,600,000	
No.2		1555	1785	1,500,000	
No.3		905	1040	1,300,000	
Stud		885	1020	1,300,000	
Construction		1210	1390	1,400,000	
Standard		660	760	1,300,000	
Utility		315	365	1,200,000	
Select Structural	2x6	1945	2235	1,700,000	
No.1		1385	1590	1,600,000	
No.2		1345	1545	1,500,000	
No.3		785	905	1,300,000	
Stud	805	925	1,300,000		
Select Structural	2x8	1795	2065	1,700,000	
No.1		1275	1470	1,600,000	
No.2		1240	1430	1,500,000	
No.3		725	835	1,300,000	
Select Structural	2x10	1645	1890	1,700,000	
No.1		1170	1345	1,600,000	
No.2		1140	1310	1,500,000	
No.3		665	765	1,300,000	
Select Structural	2x12	1495	1720	1,700,000	
No.1		1065	1225	1,600,000	
No.2		1035	1190	1,500,000	
No.3		605	695	1,300,000	

Species and Grade	Size	Design Value in Bending, "Fb"		Modulus of Elasticity "E"	Grading Rules Agency
		Normal Duration	Snow Loading		
Red Oak					
Select Structural	2x4	1985	2280	1,400,000	NELMA
No.1		1425	1635	1,300,000	
No.2		1380	1585	1,200,000	
No.3		820	940	1,100,000	
Stud		790	910	1,100,000	
Construction		1065	1225	1,200,000	
Standard		605	695	1,100,000	
Utility		290	330	1,000,000	
Select Structural	2x6	1720	1975	1,400,000	
No.1		1235	1420	1,300,000	
No.2		1195	1375	1,200,000	
No.3		710	815	1,100,000	
Stud	720	825	1,100,000		
Select Structural	2x8	1585	1825	1,400,000	
No.1		1140	1310	1,300,000	
No.2		1105	1270	1,200,000	
No.3		655	755	1,100,000	
Select Structural	2x10	1455	1675	1,400,000	
No.1		1045	1200	1,300,000	
No.2		1010	1165	1,200,000	
No.3		600	690	1,100,000	
Select Structural	2x12	1325	1520	1,400,000	
No.1		950	1090	1,300,000	
No.2		920	1060	1,200,000	
No.3		545	630	1,100,000	

Comm 20-25 APPENDIX

WISCONSIN ADMINISTRATIVE CODE

Species and Grade	Size	Design Value in Bending, "Fb"		Modulus of Elasticity "E"	Grading Rules Agency
		Normal Duration	Snow Loading		
Redwood					
Clear Structural	2x4	3020	3470	1,400,000	RIS
Select Structural		2330	2680	1,400,000	
Select Structural, open grain		1900	2180	1,100,000	
No.1		1680	1935	1,300,000	
No.1, open grain		1335	1535	1,100,000	
No.2		1595	1835	1,200,000	
No.2, open grain		1250	1440	1,000,000	
No.3		905	1040	1,100,000	
No.3, open grain		735	845	900,000	
Stud		725	835	900,000	
Construction		950	1090	900,000	
Standard		520	595	900,000	
Utility		260	300	800,000	
Clear Structural		2x6	2615	3010	
Select Structural	2020		2320	1,400,000	
Select Structural, open grain	1645		1890	1,100,000	
No.1	1460		1675	1,300,000	
No.1, open grain	1160		1330	1,100,000	
No.2	1385		1590	1,200,000	
No.2, open grain	1085		1245	1,000,000	
No.3	785		905	1,100,000	
No.3, open grain	635		730	900,000	
Stud	660		760	900,000	
Clear Structural	2x8	2415	2775	1,400,000	
Select Structural		1865	2140	1,400,000	
Select Structural, open grain		1520	1745	1,100,000	
No.1		1345	1545	1,300,000	
No.1, open grain		1070	1230	1,100,000	
No.2		1275	1470	1,200,000	
No.2, open grain		1000	1150	1,000,000	
No.3		725	835	1,100,000	
No.3, open grain	585	675	900,000		
Clear Structural	2x10	2215	2545	1,400,000	
Select Structural		1710	1965	1,400,000	
Select Structural, open grain		1390	1600	1,100,000	
No.1		1235	1420	1,300,000	
No.1, open grain		980	1125	1,100,000	
No.2		1170	1345	1,200,000	
No.2, open grain		915	1055	1,000,000	
No.3		665	765	1,100,000	
No.3, open grain	540	620	900,000		
Clear Structural	2x12	2015	2315	1,400,000	
Select Structural		1555	1785	1,400,000	
Select Structural, open grain		1265	1455	1,100,000	
No.1		1120	1290	1,300,000	
No.1, open grain		890	1025	1,100,000	
No.2		1065	1225	1,200,000	
No.2, open grain		835	960	1,000,000	
No.3		605	695	1,100,000	
No.3, open grain	490	560	900,000		

Species and Grade	Size	Design Value in Bending, "Fb"		Modulus of Elasticity "E"	Grading Rules Agency
		Normal Duration	Snow Loading		
Southern Pine					
Dense Select Structural	2x4	3510	4030	1,900,000	SPIB
Select Structural		3280	3770	1,800,000	
Non-Dense Select Structural		3050	3500	1,700,000	
No.1 Dense		2300	2650	1,800,000	
No.1		2130	2450	1,700,000	
No.1 Non-Dense		1950	2250	1,600,000	
No.2 Dense		1960	2250	1,700,000	
No.2		1720	1980	1,600,000	
No.2 Non-Dense		1550	1790	1,400,000	
No.3		980	1120	1,400,000	
Stud		1010	1160	1,400,000	
Construction		1270	1450	1,500,000	
Standard		720	825	1,300,000	
Utility		345	395	1,300,000	
Dense Select Structural		2x6	3100	3570	
Select Structural	2930		3370	1,800,000	
Non-Dense Select Structural	2700		3110	1,700,000	
No.1 Dense	2010		2310	1,800,000	
No.1	1900		2180	1,700,000	
No.1 Non-Dense	1720		1980	1,600,000	
No.2 Dense	1670		1920	1,700,000	
No.2	1440		1650	1,600,000	
No.2 Non-Dense	1320		1520	1,400,000	
No.3	865		990	1,400,000	
Stud	890	1020	1,400,000		
Dense Select Structural	2x8	2820	3240	1,900,000	
Select Structural		2650	3040	1,800,000	
Non-Dense Select Structural		2420	2780	1,700,000	
No.1 Dense		1900	2180	1,800,000	
No.1		1730	1980	1,700,000	
No.1 Non-Dense		1550	1790	1,600,000	
No.2 Dense		1610	1850	1,700,000	
No.2		1380	1590	1,600,000	
No.2 Non-Dense		1260	1450	1,400,000	
No.3		805	925	1,400,000	
Dense Select Structural	2x10	2470	2840	1,900,000	
Select Structural		2360	2710	1,800,000	
Non-Dense Select Structural		2130	2450	1,700,000	
No.1 Dense		1670	1920	1,800,000	
No.1		1500	1720	1,700,000	
No.1 Non-Dense		1380	1590	1,600,000	
No.2 Dense		1380	1590	1,700,000	
No.2		1210	1390	1,600,000	
No.2 Non-Dense		1090	1260	1,400,000	
No.3		690	795	1,400,000	
Dense Select Structural	2x12	2360	2710	1,900,000	
Select Structural		2190	2510	1,800,000	
Non-Dense Select Structural		2010	2310	1,700,000	
No.1 Dense		1550	1790	1,800,000	
No.1		1440	1650	1,700,000	
No.1 Non-Dense		1320	1520	1,600,000	
No.2 Dense		1320	1520	1,700,000	
No.2		1120	1290	1,600,000	
No.2 Non-Dense		1040	1190	1,400,000	
No.3		660	760	1,400,000	

Comm 20-25 APPENDIX

WISCONSIN ADMINISTRATIVE CODE

Species and Grade	Size	Design Value in Bending, "Fb"		Modulus of Elasticity "E"	Grading Rules Agency
		Normal Duration	Snow Loading		
Spruce-Pine-Fir					
Select Structural	2x4	2155	2480	1,500,000	NLGA
No.1 /No.2		1510	1735	1,400,000	
No.3		865	990	1,200,000	
Stud		855	980	1,200,000	
Construction		1120	1290	1,300,000	
Standard		635	725	1,200,000	
Utility		290	330	1,100,000	
Select Structural	2x6	1870	2150	1,500,000	
No.1 /No.2		1310	1505	1,400,000	
No.3		750	860	1,200,000	
Stud		775	895	1,200,000	
Select Structural	2x8	1725	1985	1,500,000	
No. 1 / No.2		1210	1390	1,400,000	
No.3		690	795	1,200,000	
Select Structural	2x10	1580	1820	1,500,000	
No.1/No.2		1105	1275	1,400,000	
No.3		635	725	1,200,000	
Select Structural	2x12	1440	1655	1,500,000	
No.1 /No.2		1005	1155	1,400,000	
No.3		575	660	1,200,000	
Spruce-Pine-Fir (South)					
Select Structural	2x4	2245	2580	1,300,000	NELMA NSLB WCLIB WWPA
No.1		1465	1685	1,200,000	
No.2		1295	1490	1,100,000	
No.3		735	845	1,000,000	
Stud		725	835	1,000,000	
Construction		980	1125	1,000,000	
Standard		545	630	900,000	
Utility		260	300	900,000	
Select Structural	2x6	1945	2235	1,300,000	
No.1		1270	1460	1,200,000	
No.2		1120	1290	1,100,000	
No.3		635	730	1,000,000	
Stud		660	760	1,000,000	
Select Structural	2x8	1795	2065	1,300,000	
No.1		1175	1350	1,200,000	
No.2		1035	1190	1,100,000	
No.3	585	675	1,000,000		
Select Structural	2x10	1645	1890	1,300,000	
No.1		1075	1235	1,200,000	
No.2		950	1090	1,100,000	
No.3		540	620	1,000,000	
Select Structural	2x12	1495	1720	1,300,000	
No.1		980	1125	1,200,000	
No.2		865	990	1,100,000	
No.3	490	560	1,000,000		

Species and Grade	Size	Design Value in Bending, "Fb"		Modulus of Elasticity "E"	Grading Rules Agency
		Normal Duration	Snow Loading		
Western Cedars					
Select Structural	2x4	1725	1985	1,100,000	WCLIB WWPA
No.1		1250	1440	1,000,000	
No.2		1210	1390	1,000,000	
No.3		690	795	900,000	
Stud		695	800	900,000	
Construction		920	1060	900,000	
Standard		520	595	800,000	
Utility		260	300	800,000	
Select Structural	2x6	1495	1720	1,100,000	
No.1		1085	1245	1,000,000	
No.2		1045	1205	1,000,000	
No.3		600	690	900,000	
Stud	635	725	900,000		
Select Structural	2x8	1380	1585	1,100,000	
No.1		1000	1150	1,000,000	
No.2		965	1110	1,000,000	
No.3		550	635	900,000	
Select Structural	2x10	1265	1455	1,100,000	
No.1		915	1055	1,000,000	
No.2		885	1020	1,000,000	
No.3	505	580	900,000		
Select Structural	2x12	1150	1325	1,100,000	
No.1		835	960	1,000,000	
No.2		805	925	1,000,000	
No.3		460	530	900,000	
Western Woods					
Select Structural	2x4	1510	1735	1,200,000	WCLIB WWPA
No.1		1120	1290	1,100,000	
No.2		1120	1290	1,000,000	
No.3		645	745	900,000	
Stud		635	725	900,000	
Construction		835	960	1,000,000	
Standard		460	530	900,000	
Utility		230	265	800,000	
Select Structural	2x6	1310	1505	1,200,000	
No.1		970	1120	1,100,000	
No.2		970	1120	1,000,000	
No.3		560	645	900,000	
Stud	575	660	900,000		
Select Structural	2x8	1210	1390	1,200,000	
No.1		895	1030	1,100,000	
No.2		895	1030	1,000,000	
No.3	520	595	900,000		
Select Structural	2x10	110	1275	1,200,000	
No.1		820	945	1,100,000	
No.2		820	945	1,000,000	
No.3		475	545	900,000	
Select Structural	2x12	1005	1155	1,200,000	
No.1		750	860	1,100,000	
No.2		750	860	1,000,000	
No.3	430	495	900,000		

Comm 20-25 APPENDIX

WISCONSIN ADMINISTRATIVE CODE

Species and Grade	Size	Design Value in Bending, "Fb"		Modulus of Elasticity "E"	Grading Rules Agency
		Normal Duration	Snow Loading		
White Oak					
Select Structural	2x4	2070	2380	1,100,000	NELMA
No.1		1510	1735	1,000,000	
No.2		1465	1685	900,000	
No.3		820	940	800,000	
Stud		820	945	800,000	
Construction		1095	1255	900,000	
Standard		605	695	800,000	
Utility		290	330	800,000	
Select Structural	2x6	1795	2065	1,100,000	
No.1		1310	1505	1,000,000	
No.2		1270	1460	900,000	
No.3		710	815	800,000	
Stud	750	860	800,000		
Select Structural	2x8	1655	1905	1,100,000	
No.1		1210	1390	1,000,000	
No.2		1175	1350	900,000	
No.3		655	755	800,000	
Select Structural	2x10	1520	1745	1,100,000	
No.1		1105	1275	1,000,000	
No.2		1075	1235	900,000	
No.3		600	690	800,000	
Select Structural	2x12	1380	1585	1,100,000	
No.1		1005	1155	1,000,000	
No.2		980	1125	900,000	
No.3		545	630	800,000	
Yellow Poplar					
Select Structural	2x4	1725	1985	1,500,000	NSLB
No.1		1250	1440	1,400,000	
No.2		1210	1390	1,300,000	
No.3		690	795	1,200,000	
Stud		695	800	1,200,000	
Construction		920	1060	1,300,000	
Standard		520	595	1,100,000	
Utility		230	265	1,100,000	
Select Structural	2x6	1495	1720	1,500,000	
No.1		1055	1245	1,400,000	
No.2		1045	1205	1,300,000	
No.3		600	690	1,200,000	
Stud	635	725	1,200,000		
Select Structural	2x8	1380	1585	1,500,000	
No.1		1000	1150	1,400,000	
No.2		965	1110	1,300,000	
No.3		550	635	1,200,000	
Select Structural	2x10	1265	1455	1,500,000	
No.1		915	1055	1,400,000	
No.2		885	1020	1,300,000	
No.3		505	580	1,200,000	
Select Structural	2x12	1150	1325	1,500,000	
No.1		835	960	1,400,000	
No.2		805	925	1,300,000	
No.3		460	530	1,200,000	

21.04(2)(a)5. HANDRAIL SHAPES

ROUND

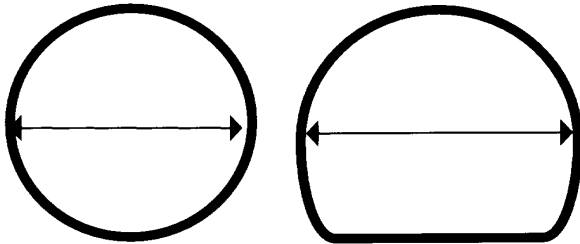

**MAXIMUM 2"
DIAMETER**

RECTANGULAR

OK (w x ht):
1/2" x 2-5/8"
3/4" x 2-1/2"
1" x 2-3/8"
1-1/8" x 2-5/16"
1-1/2" x 2-1/8"
1-7/8" x 1-15/16"

OK (w x ht):
2" x 1-7/8"
2-1/2" x 1-5/8"
2-3/4" x 1-1/2"
2-7/8" x 1/2" TO 1-7/16"

**MAXIMUM 2-7/8"
CROSS SECTION**
**MAX. 6-1/4"
GRIPPING
SURFACE INCL.
MIN. 1/4"
RECESS ON
EACH SIDE**

OTHERS

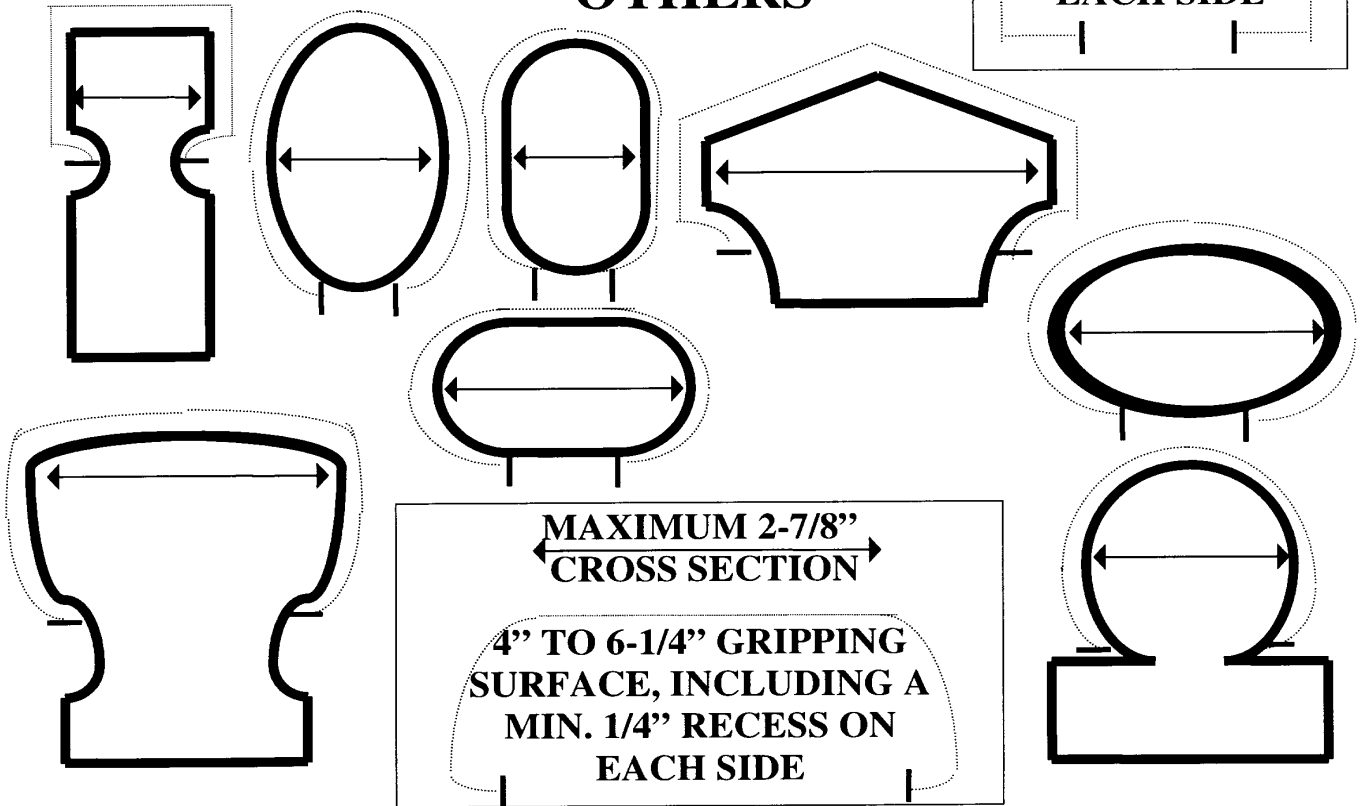

**MAXIMUM 2-7/8"
CROSS SECTION**
**4" TO 6-1/4" GRIPPING
SURFACE, INCLUDING A
MIN. 1/4" RECESS ON
EACH SIDE**

**EROSION CONTROL PROCEDURES
EXAMPLES, ILLUSTRATIONS AND GUIDELINES**

The following examples and illustrations of some erosion control procedures are provided for your information. Many of these examples can be found in the “Wisconsin Construction Site Best Management Practices Handbook”, developed by the Wisconsin department of natural resources. Note: The Handbook is available from Document sales, 202 South Thornton Avenue, P.O. Box 7840, Madison, WI 53707-8480; phone (608) 266-3358.

Figures E-1 to E-11, depict the materials and installation of some erosion control procedures.

Also included in the appendix are examples of plot plans depicting the best management practices that will help meet the requirements of the performance standards in this code.

Figure E – 12 is an example of a site with slopes of 12 % or less and also simple slopes, i.e. all slopes occurring in one general direction. Downslope measures are required, to reduce maintenance of these measures, the upslope diversion is recommended.

Figure E – 13 is an example of a site with complex slopes (slopes occurring in more than one direction). This site also has an area where slopes that are 12-20% are going to be disturbed. The location of the erosion control procedures are clearly indicated on the plot plan, including narratives that indicated methods of permanent stabilization.

Figure E – 14 is an example of a large lot, greater than 5 acres, with slopes greater than 12% and where the area of land disturbing activity is indicated. This plan indicates the use of vegetative barriers.

Figure E – 15 explains how to determine and calculate % slopes.

Guidelines for timing the implementation of the erosion control practices and procedures in order to stabilize areas disturbed during construction of one and 2-family dwellings are included in this appendix. Dormant seeding, the guidelines for the use of vegetative buffers and the recommended maintenance for erosion control practices are also included.

For sites using either straw bales or silt fences as a perimeter control, **Table E-1** is included as a guide for determining the distance between parallel fences constructed on various slopes. Perimeter measures should be installed at right angles to the direction of flow. Drainage area is to be no more than 1/4 acres (approx. 10,000 square feet) per 100 feet of perimeter control.

**TABLE E-1
DISTANCE BETWEEN PARALLEL
STRAW BALES OR SILT FENCES**

Slope Percent	Slope Distance (feet)
< 2%	100 feet
2 to 5%	75 feet
5 to 10%	50 feet
10 to 20%	25 feet
> 20%	15 feet

VEGETATIVE BARRIERS

Vegetative barriers may be used as a perimeter measure if disturbed areas above consist of slopes no greater than 6% and barriers are on a grade no steeper than 5%. Vegetative barriers are to be a minimum of 10' wide for every 50 feet of open ground draining to them. These barriers must be maintained, i.e. not driven on or destroyed. If the barriers become covered with silt or otherwise destroyed, additional perimeter measures may be required.

TEMPORARY STABILIZATION OR MULCH CROP

It is much easier to control erosion than to control sediment. Temporary stabilization helps to minimize erosion and therefore the need for long term maintenance of silt fences and straw bales. Annual rye grass may be planted as a temporary cover between April 1 and September 15. If seeding is done in the spring or late summer seeding dates and slopes are 6% or less, mulch may not be necessary.

Winter rye may be planted between July 15 and October 15. These seedings should be mulched.

LATE SEASON CONSTRUCTION MULCHING/DORMANT SEEDING

If ground is broken after September 15, mulch should be applied as soon as a rough grade is established, unless final grade and landscaping is to be completed before the next growing season. Mulch will help to reduce the raindrop impact. Seeding should not be done between September 15 and November 1 as the weather is warm enough for the seed to germinate but it will not have an opportunity to establish a root system strong enough to survive the winter. A dormant seeding may be done OVER the mulch after November 1. These seedings are risky. A split application of seed may also be made, using half in November and balance early in spring.

WINTER CONSTRUCTION

In areas with course soils, (sands) if excavation is possible most likely a trencher can be used to install the necessary silt fence. If at all possible leave the perimeter of the site undisturbed (this is assuming the site had vegetation present prior to frost); this may be the easiest erosion control for flat sites (6% or less).

In areas that have heavy soils, (clays) close attention should be paid to the try to get perimeter measures installed prior to frost penetrating greater than 6". If ground is solidly frozen, perimeter measures that need to be trenched may have to wait to be installed when the frost first starts to come out in the spring. This does not eliminate the need to keep sediment from leaving the site. Alternate methods for controlling erosion should be considered such as the use of soil stabilizers.

MAINTENANCE OF THE MOST COMMONLY USED EROSION CONTROL PROCEDURES

SILT FENCES

Repair or replacement should be done within 24 hours if fencing is torn, sagging, overtopped, blown over (laying down), shows a lack of integrity, or in any way is not functioning as designed. Sediment deposits should be removed after each storm event. Sediment deposits shall be removed when deposits reach 0.5 the above ground height of the fence. Silt fence should be removed after upland areas have been stabilized. Any sediment deposits remaining in place after the silt fence is no longer required should be dressed to conform to the existing grade, prepared and stabilized.

STRAWBALES

Replacement of broken or torn bales should be done within 24 hours. Sediment deposits should be removed when deposits reach 0.5 the height of the bales. Strawbales should be removed after upland areas have been stabilized. Any sediment deposits remaining in place after the strawbale barrier is no longer required should be dressed to conform to the existing grade, prepared and stabilized.

MULCHING

Additional mulch or matting should be applied when rills develop (rill – small, eroded ditch measuring 1” or less width).

TEMPORARY DIVERSION

Any breaks or eroded areas of a diversion should be repaired within 24 hours.

SEDIMENT TRAP

Any structural deficiencies should be repaired within 24 hours. Sediment should be removed when it reaches half of the outlet height of trap.

SODDING

Repair or replacement of sod that has been destroyed in an area of channelized flow should be done within 24 hours after the rain event.

INLET PROTECTION BARRIERS

Sediment deposits should be removed when deposits reach 0.5 the height of the fence. Repair or replacement should be made to damaged barriers within 24 hours.

TEMPORARY GRAVEL CONSTRUCTION ENTRANCE

Rock should be maintained to meet the design criteria of 2–3” aggregate stone; 12 feet wide and 50 feet long or the distance to the foundation, whichever is less; and maintained at a depth of 6”. Filter fabric (geotextile) should be used as a separation barrier between the rock and soil if soils are mainly clay or silt.

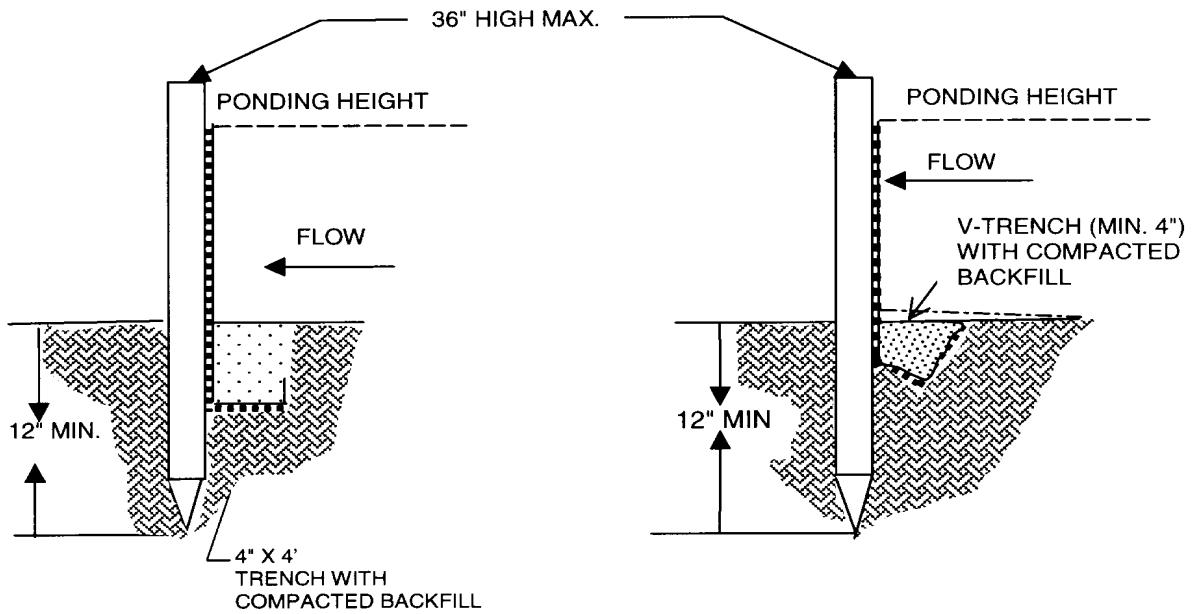
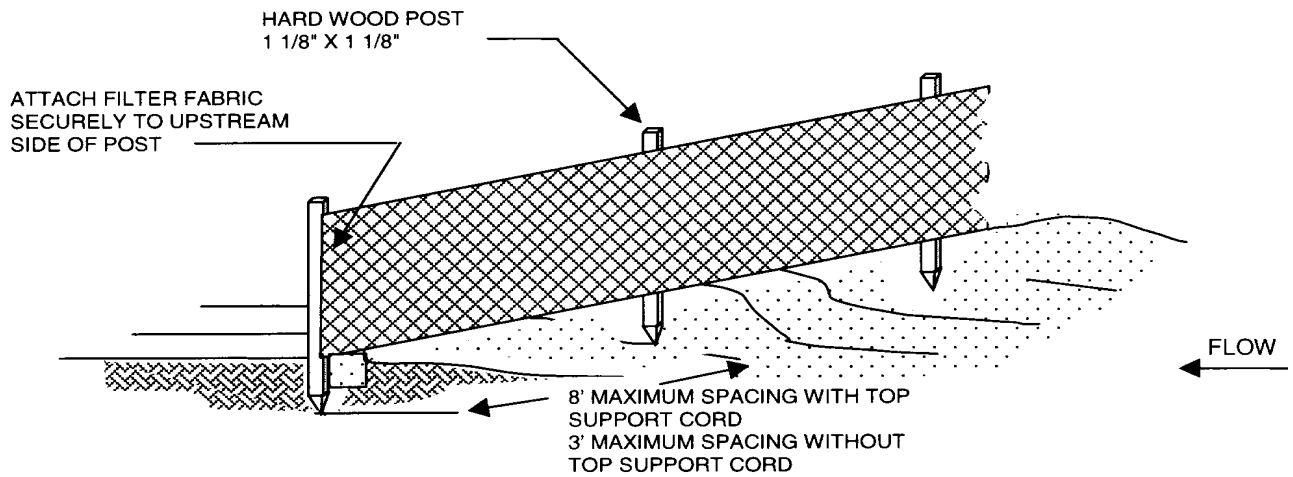

NOTES:

1. SILT FENCE SHALL BE PLACED ON SLOPE CONTOURS TO MAXIMIZE PONDING EFFICIENCY.
2. THE ENDS OF THE FENCE SHALL BE TURNED UPSLOPE TO PREVENT WATER FROM RUNNING AROUND THE ENDS OF THE FENCE.
3. INSPECT AND REPAIR FENCE AFTER EACH STORM EVENT AND REMOVE SEDIMENT WHEN NECESSARY (9" MAXIMUM RECOMMENDED STORAGE HEIGHT)
4. REMOVED SEDIMENT SHALL BE DEPOSITED TO AN AREA THAT WILL NOT CONTRIBUTE SEDIMENT OFF-SITE AND CAN BE PERMANENTLY STABILIZED.

NOT TO SCALE

FIG. E - 1
SILT FENCE

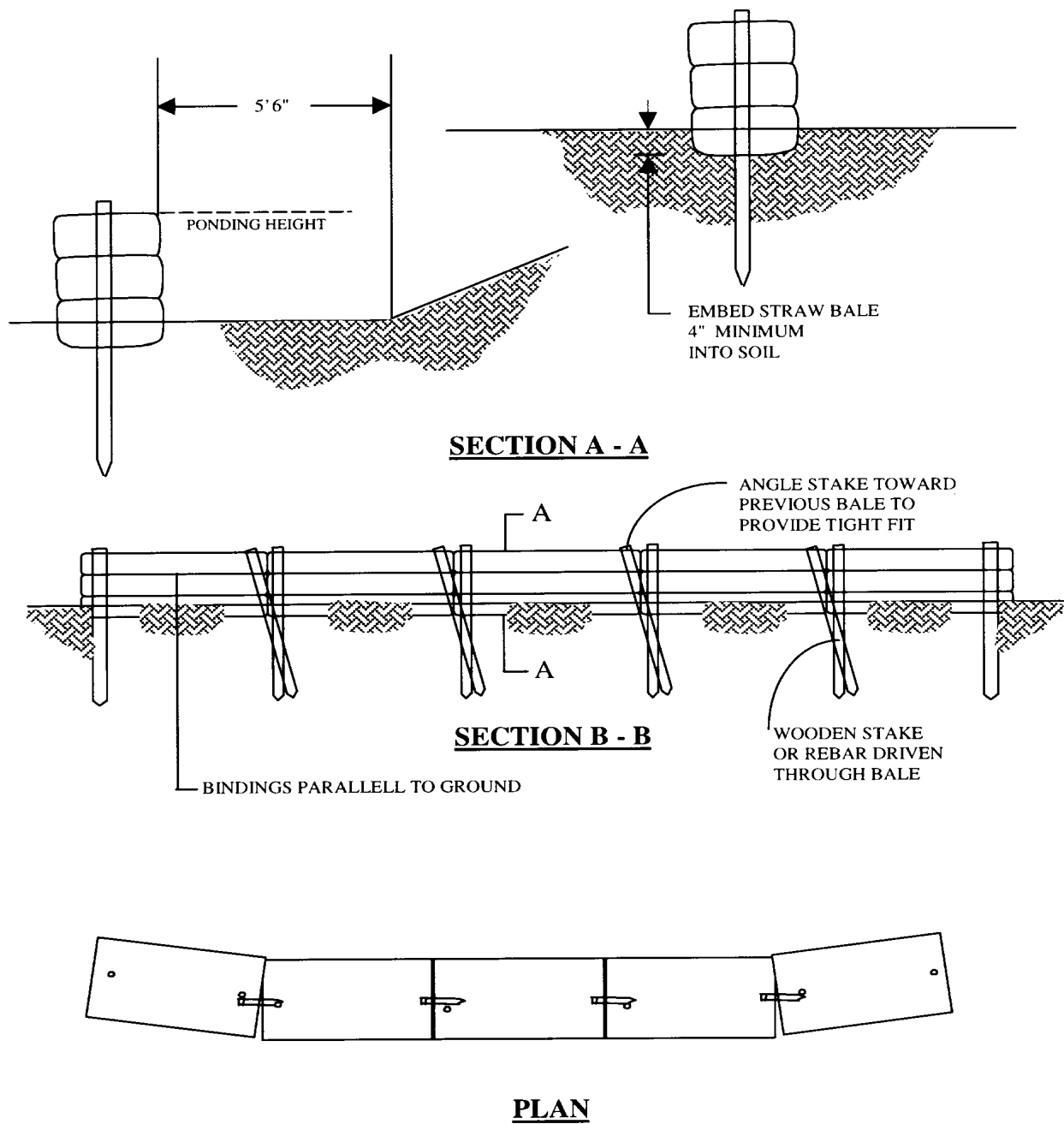

NOTES:

1. THE STRAW BALES SHALL BE PLACED ON SLOPE CONTOUR WITH ENDS OF STRAW BALE FENCE TURNED UPSLOPE TO PREVENT FLANKING
2. BALES TO BE PLACED SO THAT BINDINGS ARE ORIENTED AROUND THE SIDES RATHER THAN ALONG THE TOPS AND BOTTOMS OF THE BALES.
3. BALES TO BE PLACED IN A ROW WITH THE ENDS TIGHTLY ABUTTING.
4. KEY IN BALES 4" INTO SOIL TO PREVENT EROSION OR FLOW UNDER BALES

FIG. E - 2
STRAW BALE FENCE

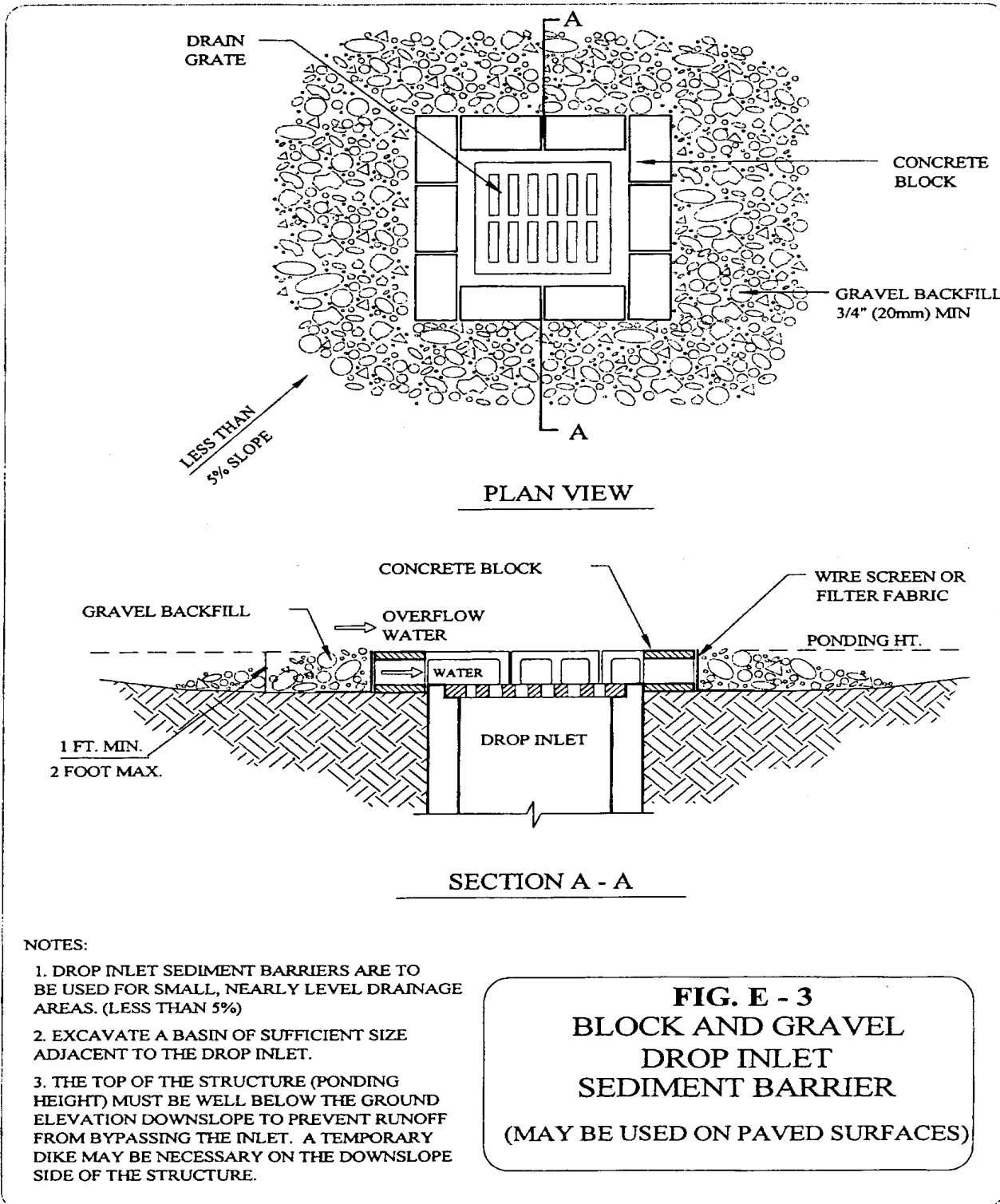

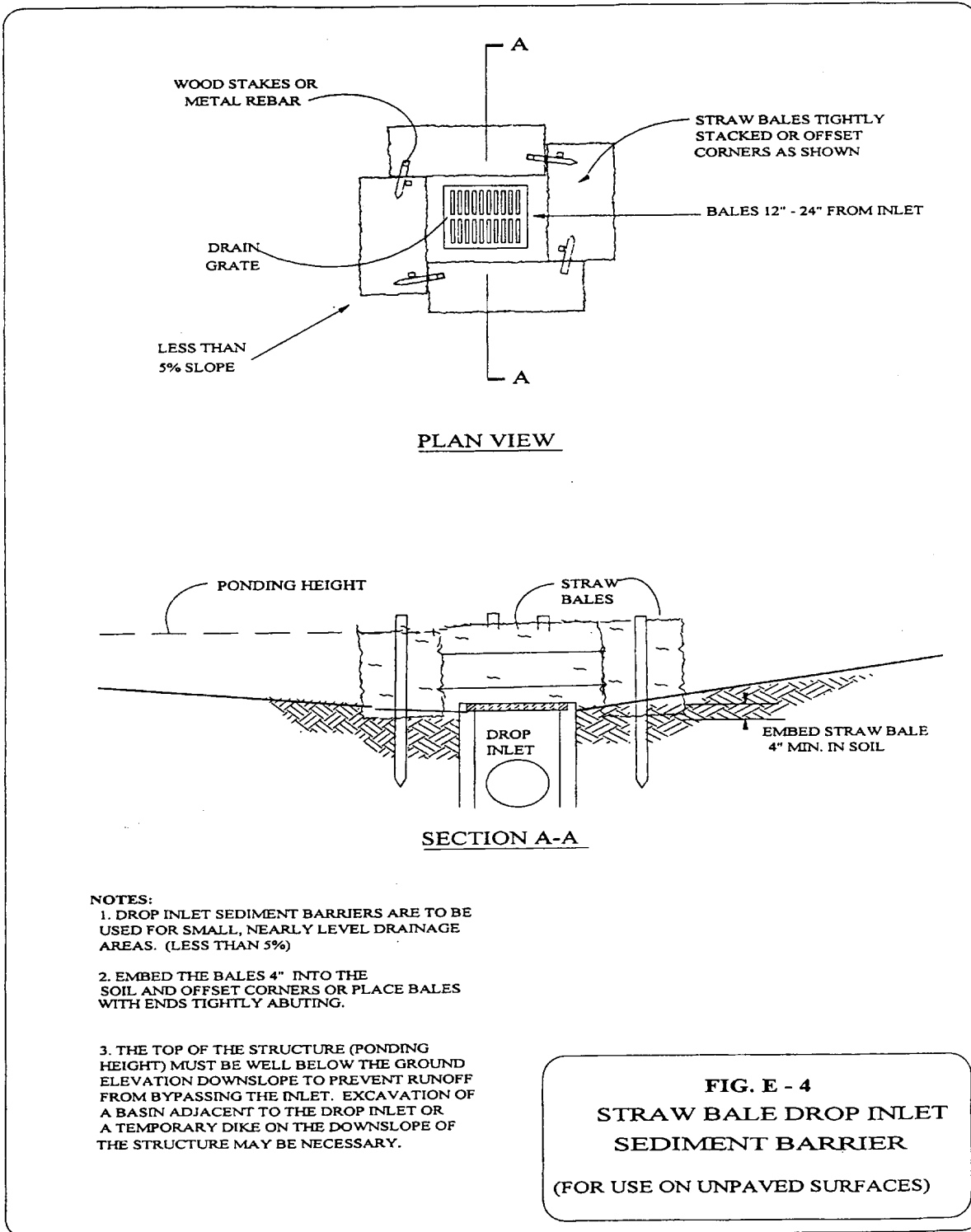

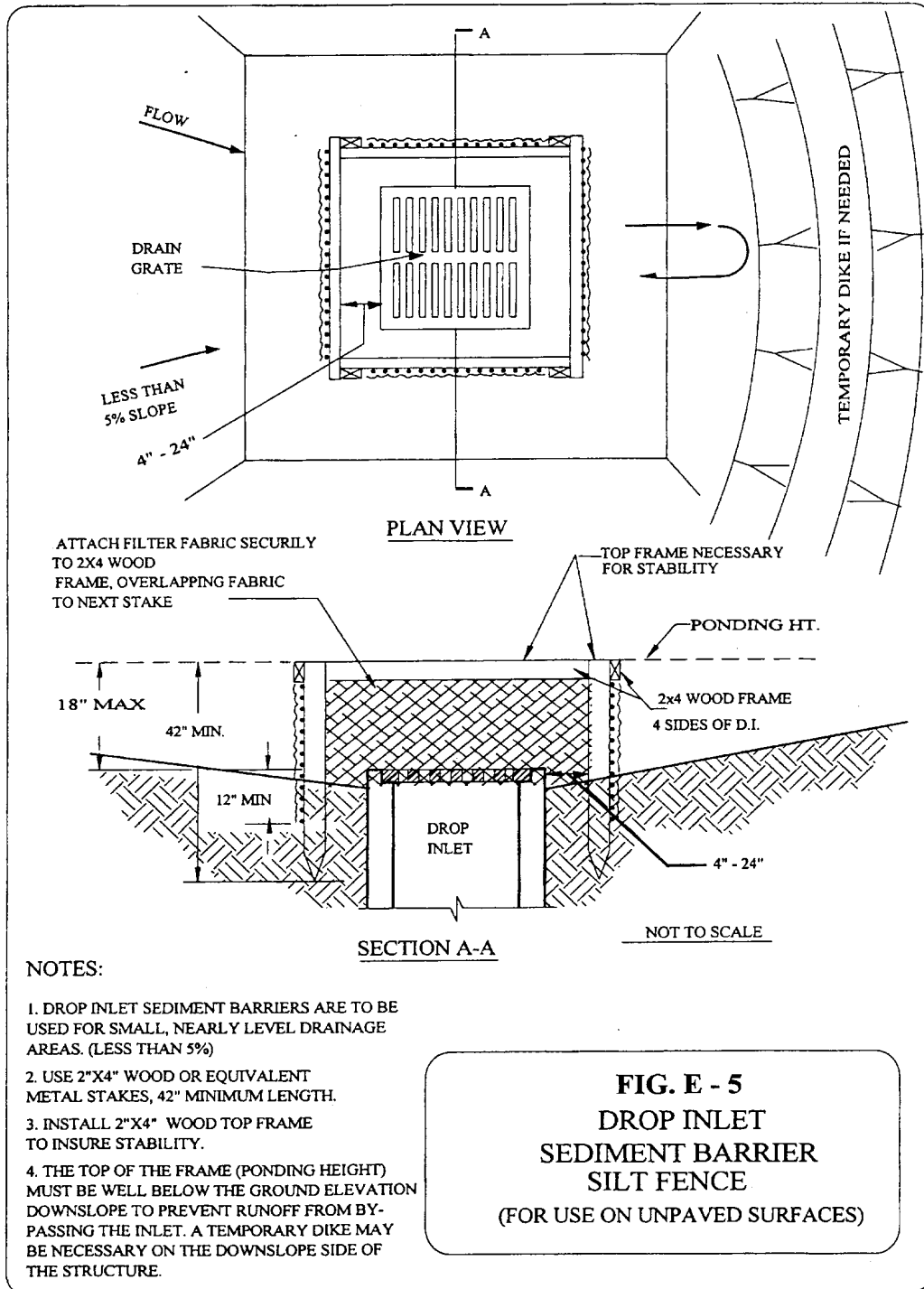

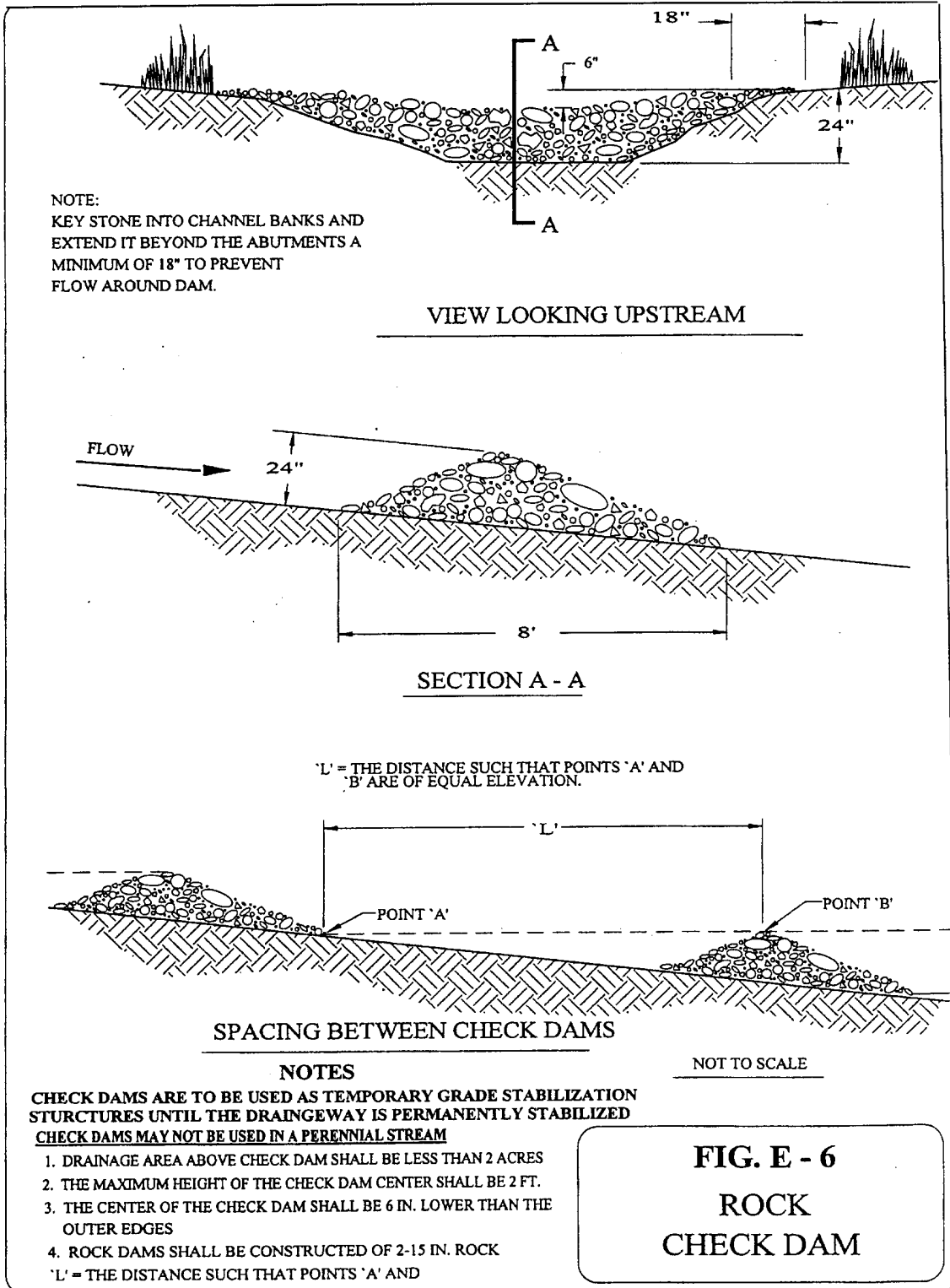

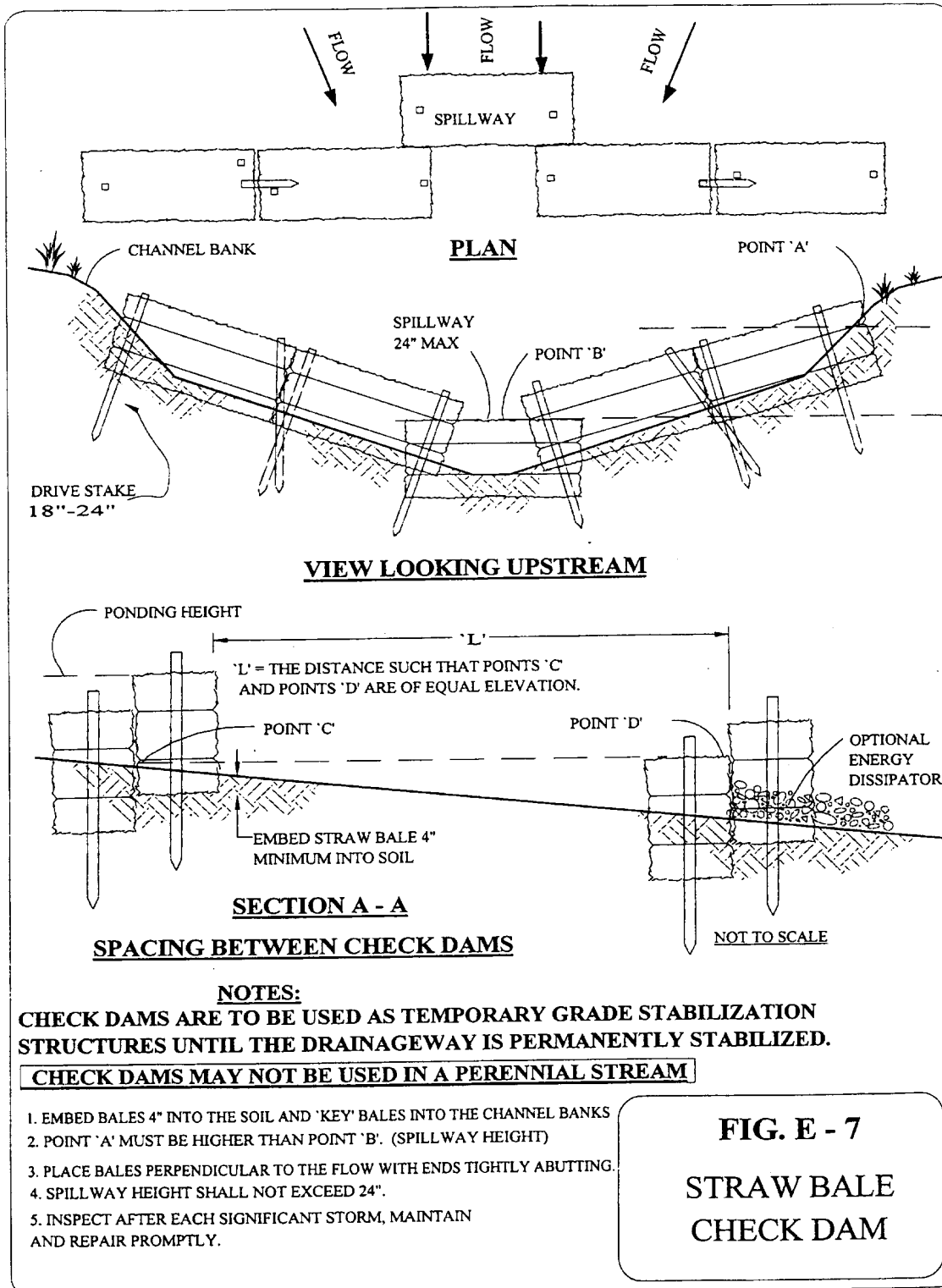
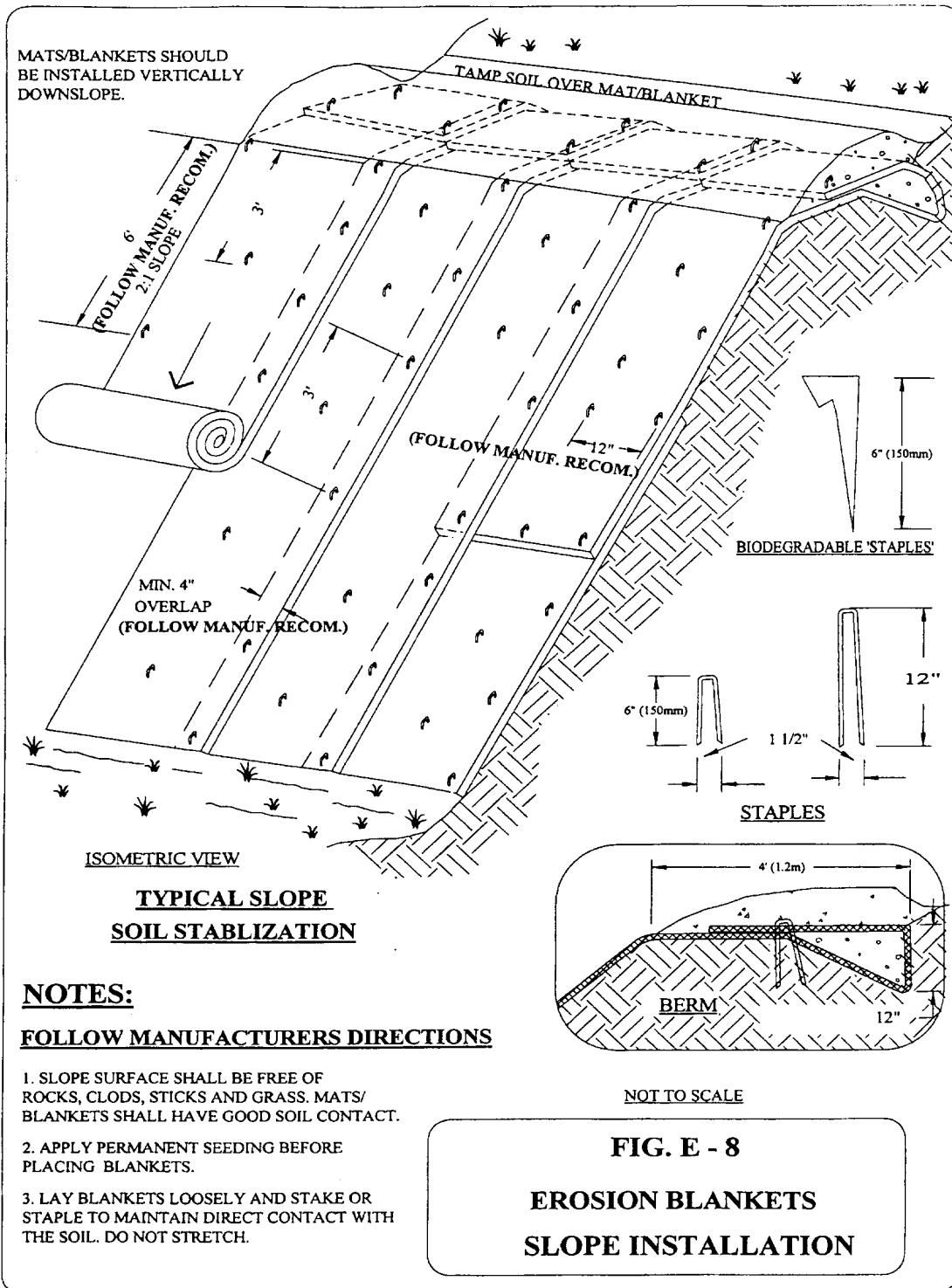
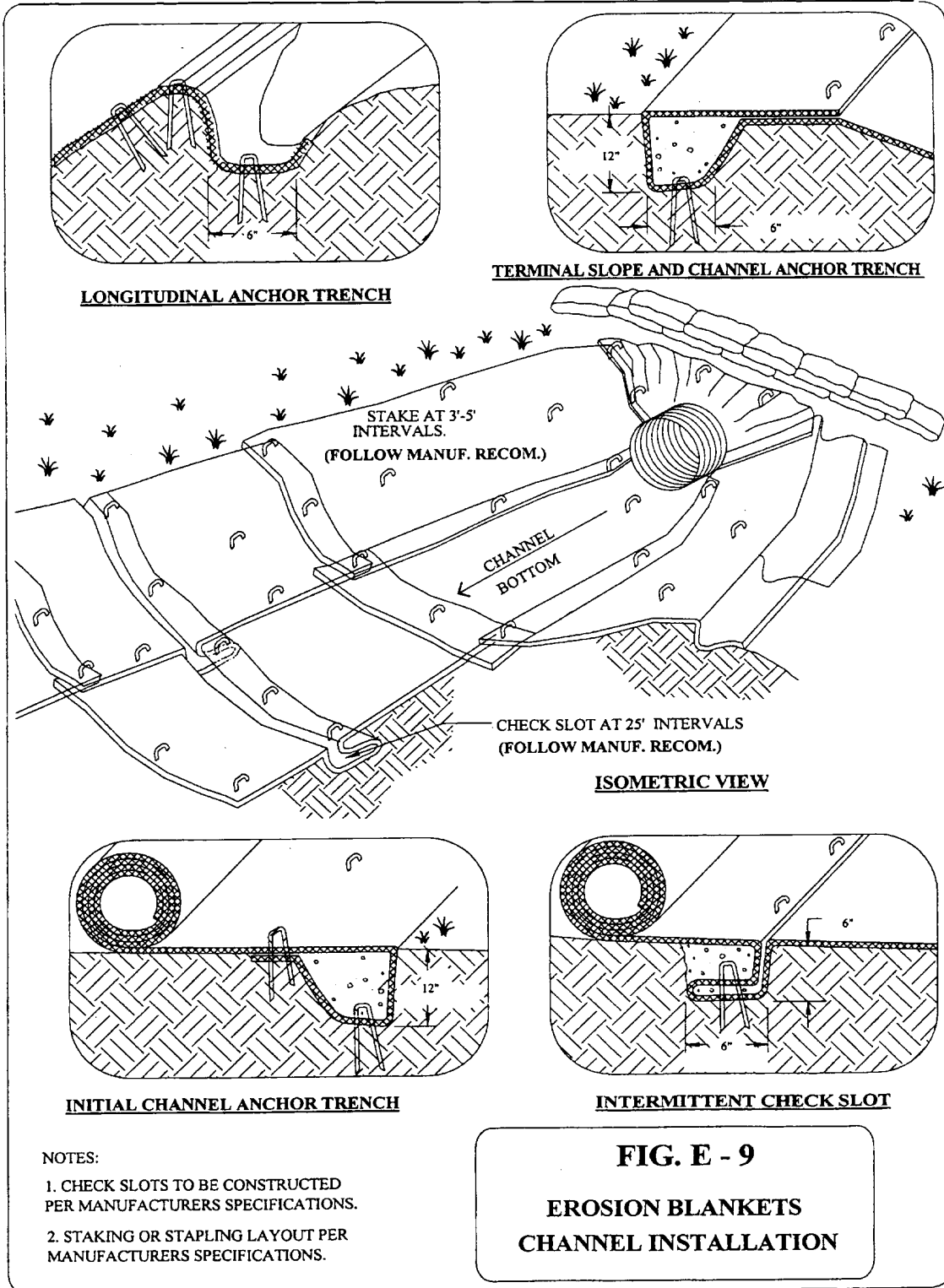
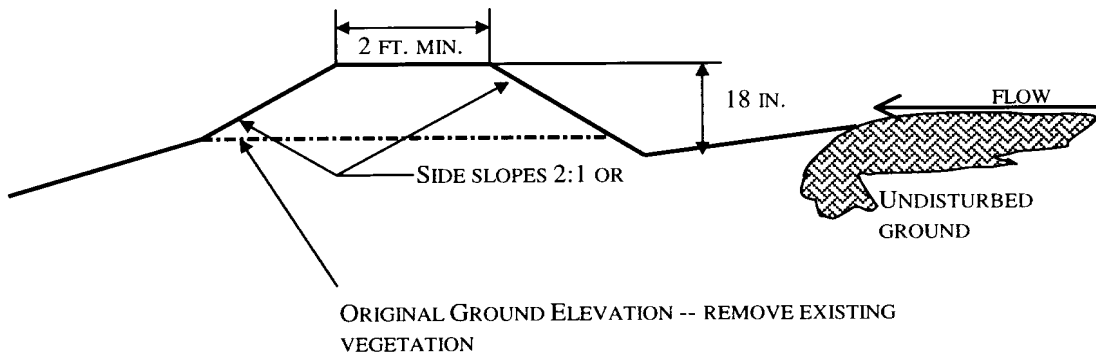

FIG. E - 7
STRAW BALE
CHECK DAM







PURPOSE

To divert runoff around disturbed areas to a location where the clean water can be discharged to existing vegetation in such a way as to prevent any negative offsite impacts.

CONDITIONS WHERE PRACTICE APPLIES

1. Where drainage areas do not exceed 3 acres.
2. Upslope of disturbed areas where erosion is likely to occur.
3. Upslope of soil piles.
4. Above steep cut or fill slopes.

STABILIZATION

Diversions side slopes, ridge, downslope side of the berm and channel should be stabilized within 7 days of final grading by:

1. Sodding;
2. seeding and mulching in combination with filter fabric barriers or straw bale barriers;
3. covering with suitable geotextile;
4. covering with 6 mil polyethylene sheeting.
(vegetation should be used as the stabilization method if diversion is to be in place 30 days or longer)

FIG. E – 10
TEMPORARY
DIVERSION

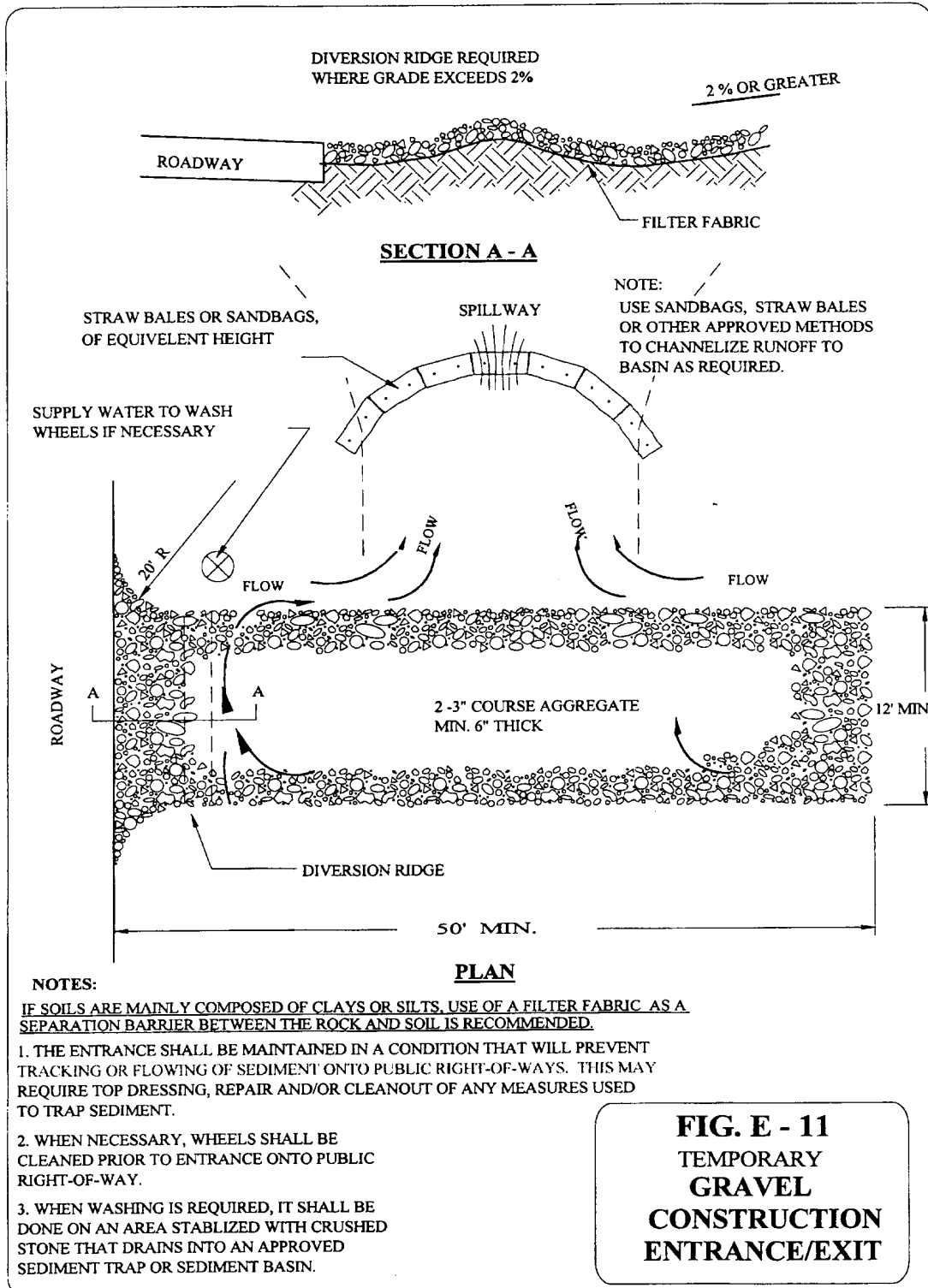

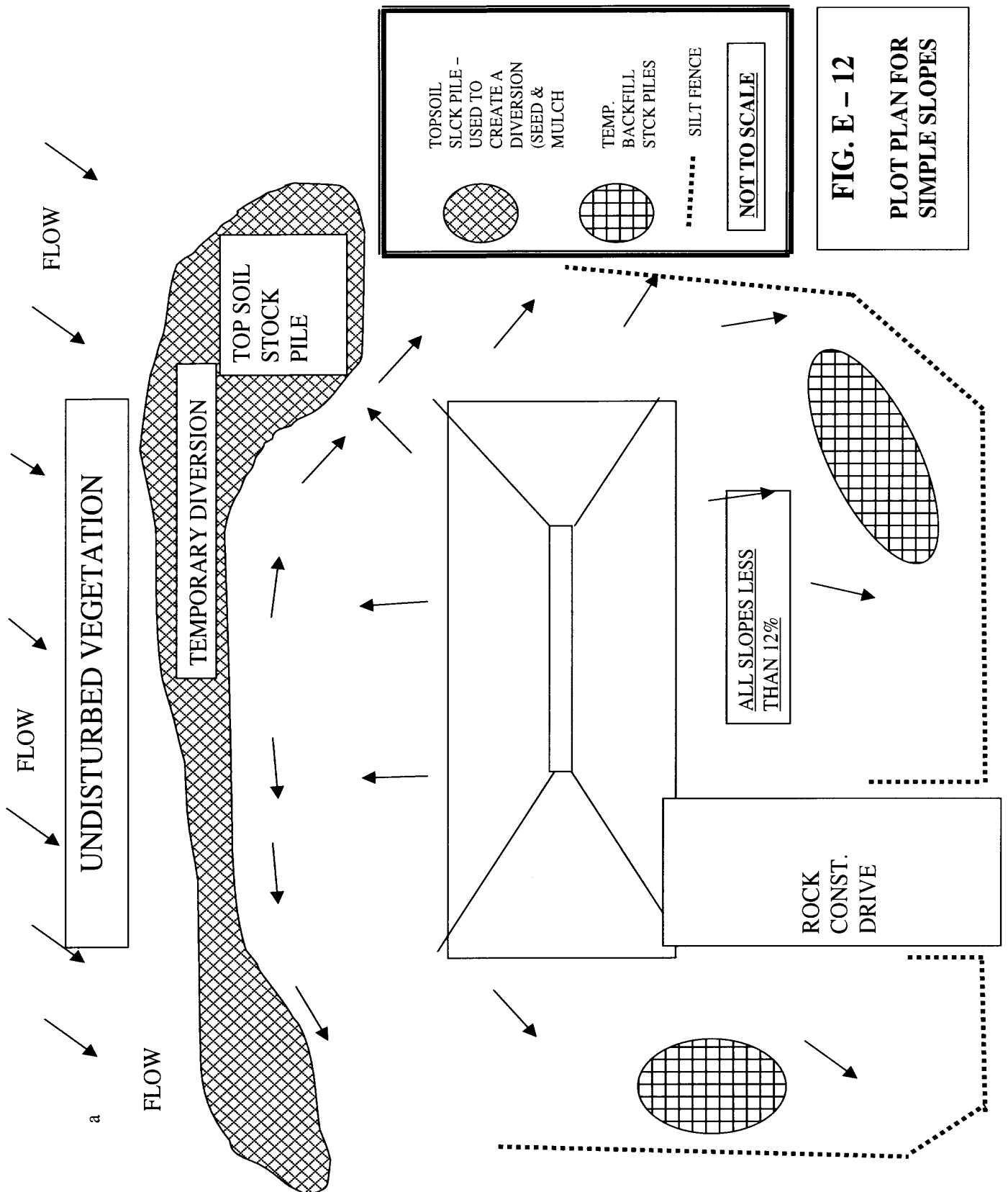

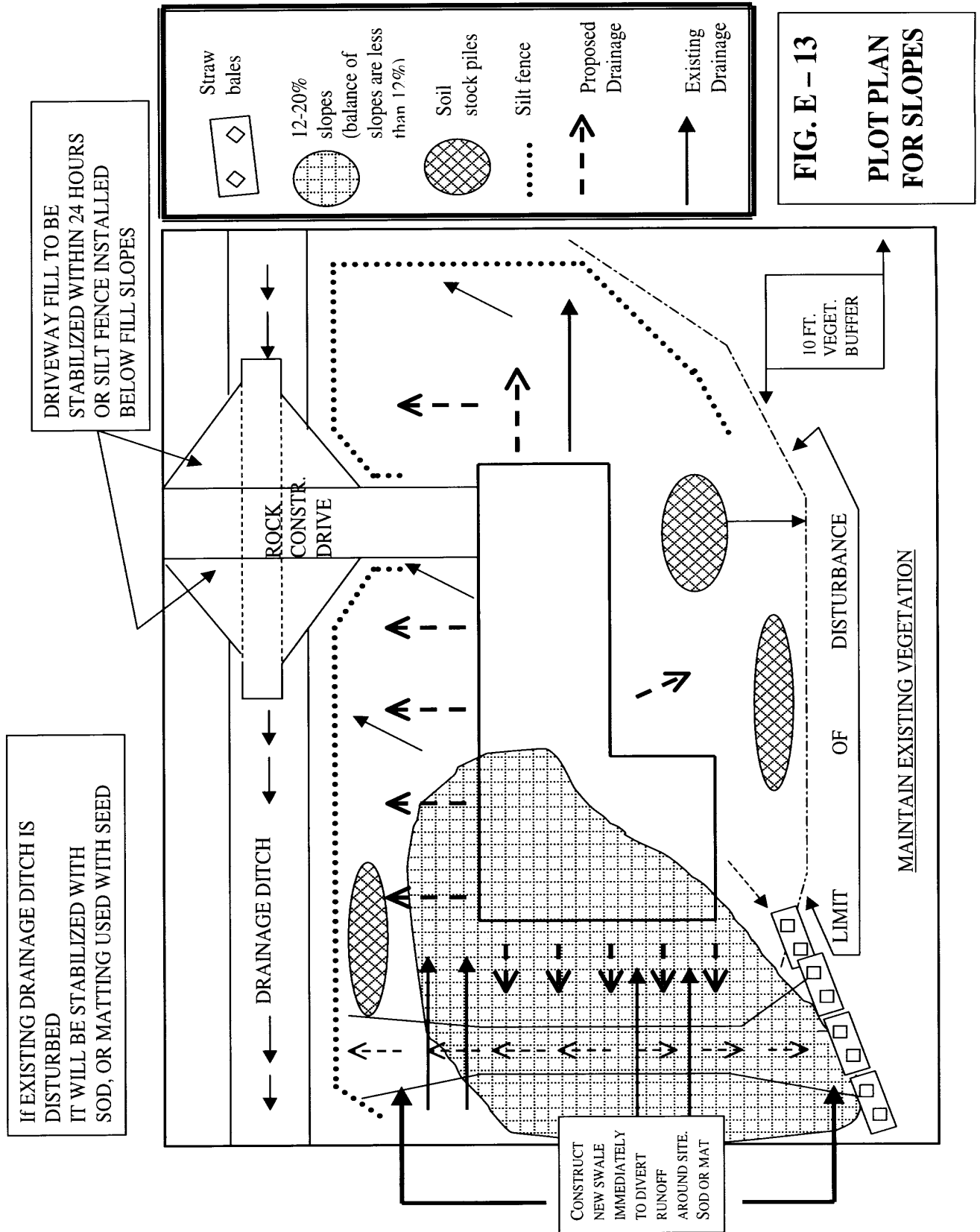

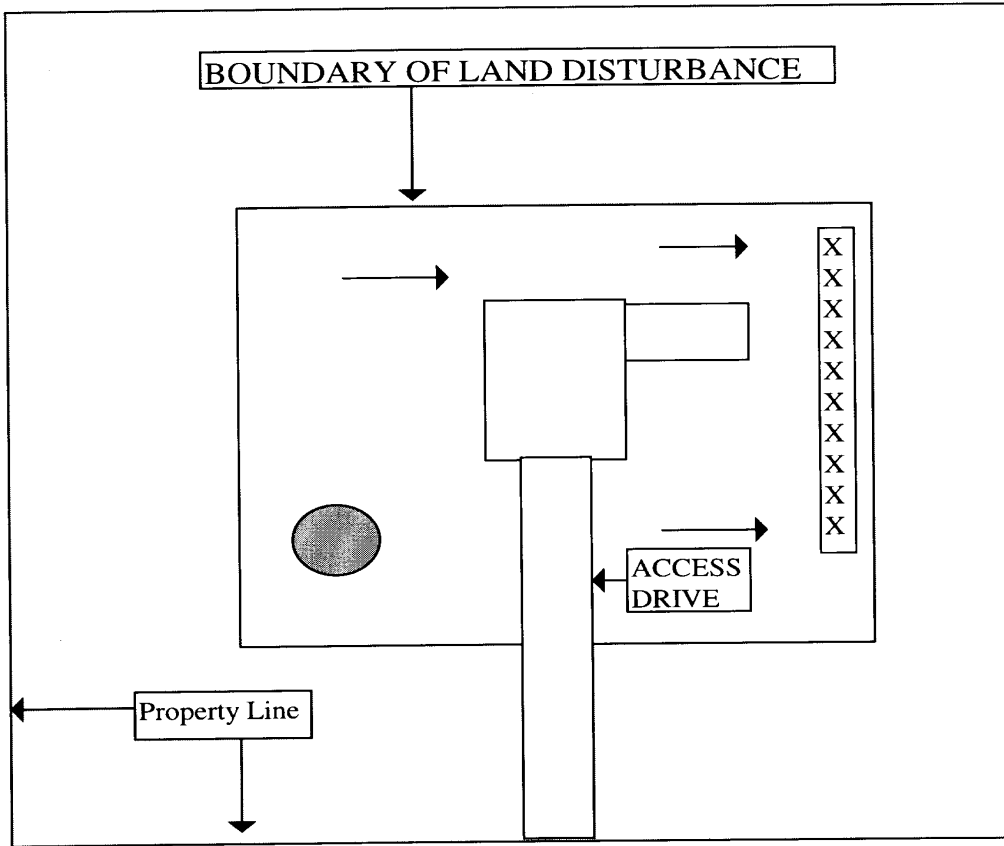

NOTES:

1. INDICATES BOUNDARY OF LAND DISTURBING ACTIVITY
2. INDICATE SLOPES IN DISTURBED AREAS BY RANGES:
12% OR LESS
12-20%
20% OR STEEPER

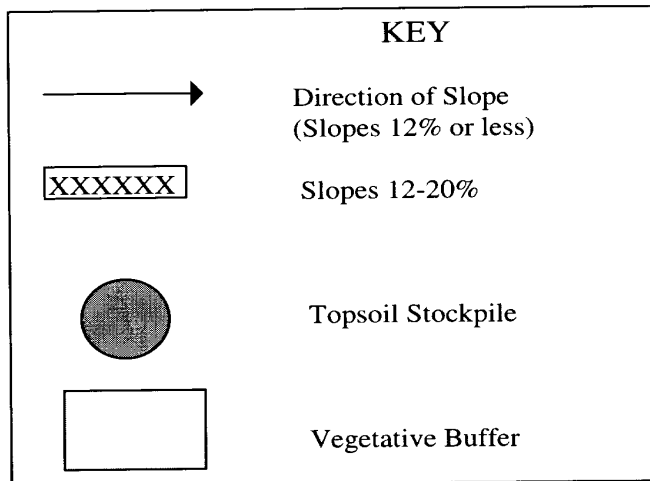
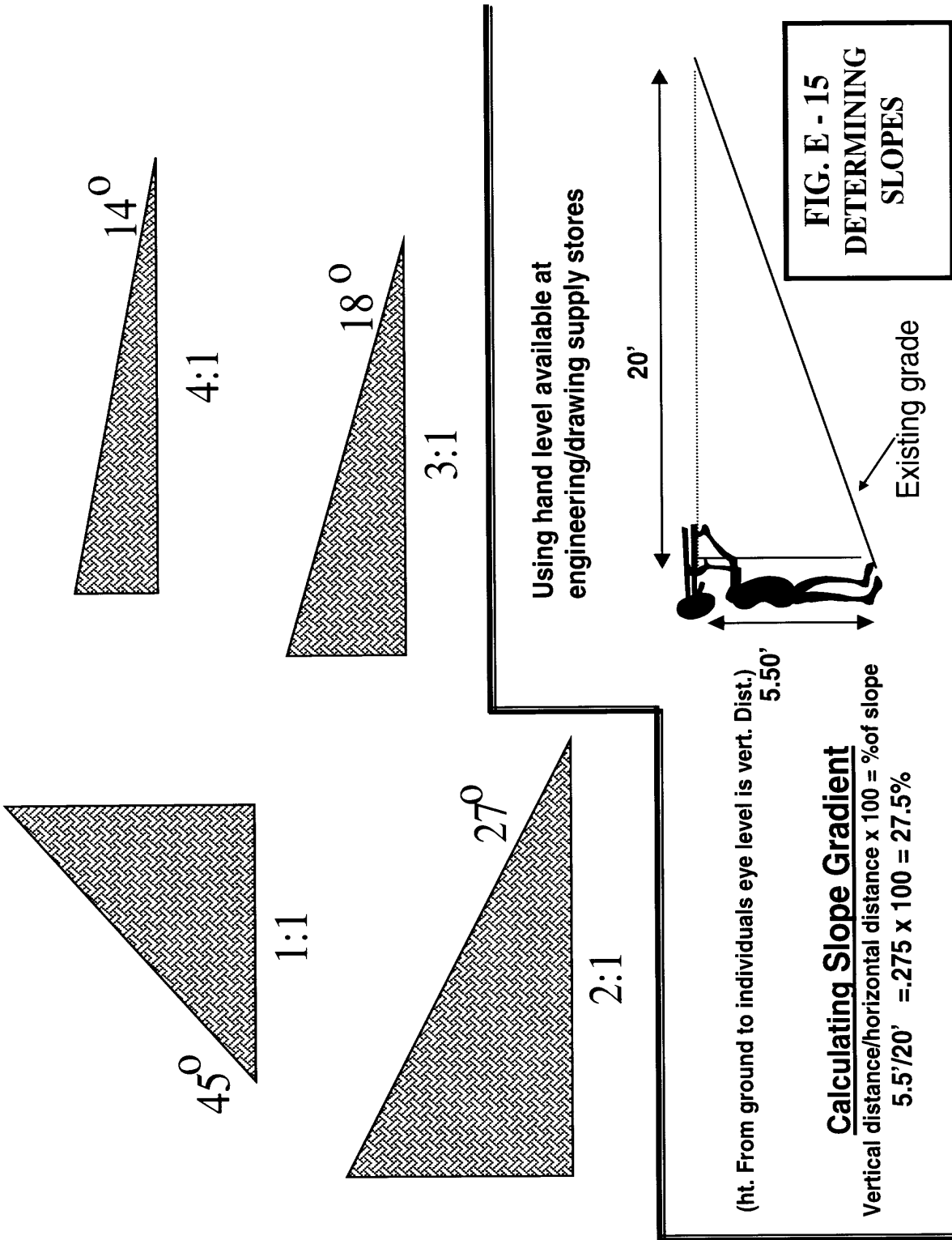

FIG. E - 14
EROSION CONTROL PLAN FOR LARGE LOT



s. Comm 21.16

Frost Protected Shallow Footings

In lieu of frost walls, the following is an acceptable method.

Minimum Ground Insulation Requirements (1)

Air Freezing Index (F-days) (3)	W-Insulation Width from Edge of Footing (4, 5)	Mean Annual Temperature (2, 6)			Minimum Footing Depth (7, 8)	
		38	40	≥41	D-Concrete Depth	G-Granular Base Thickness
2250 or less	63"	NA	NA	2.5"	10"	6"
2251 - 3000	79"	4"	3.5"	3.5"	10"	6"
3001 - 3750	91"	5"	NA	NA	10"	6"

Notes:

1. Recommendations are based on information found in "Design Guide for Frost-Protected shallow Foundations" prepared for the U. S. Department of Housing and Urban Development by NAHB Research Center (Instrument 3: DU100K000005987, dated June 1994)
2. Units are degrees Fahrenheit. See estimate provided on Mean Annual Temperature Contour Map.
3. Air freezing index shall be based on maximum year expected for a 100 year return period. See estimate provided on AFI Contour Map.
4. Ground insulation to the building interior can be extended beneath the entire slab where it is desired to protect the entire slab from frost heave action.
5. Ground insulation to the building interior can be in one horizontal plane (as shown in the detail) and covered with non frost-susceptible fill or the insulation maybe placed directly beneath the slab.
6. Insulation thickness recommendations are for extruded polystyrene (XPS) insulation.
7. The minimum depth of concrete footing and horizontal insulation is 10". A 6" drainage layer is required under the insulation.
8. Insulation placed directly beneath the footing shall be Type IV or Type VI XPS in accordance with ASTM C578. Maximum deadload placed on the Type IV insulation shall be 1200 pounds/square foot. Maximum deadload placed on Type VI shall be 1900 psf.

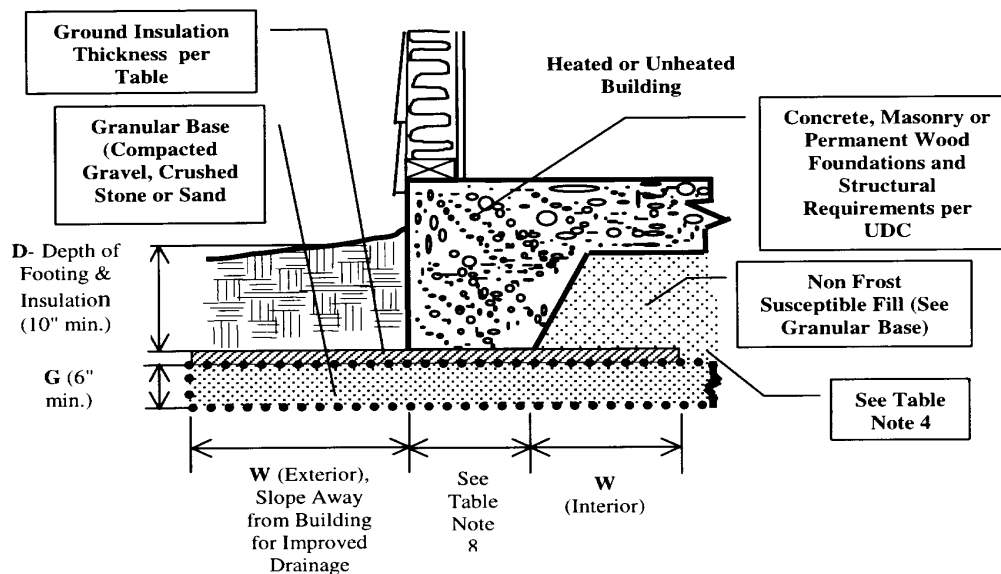

Plan View

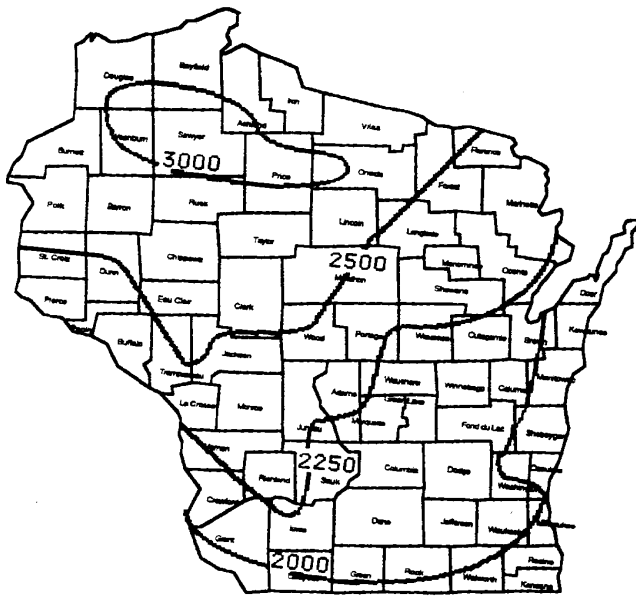
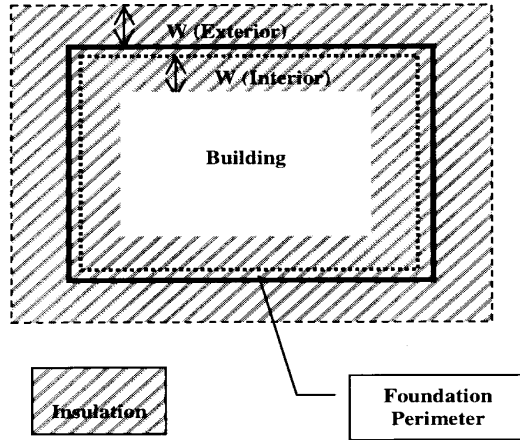

Air-Freeze Index Contour Map

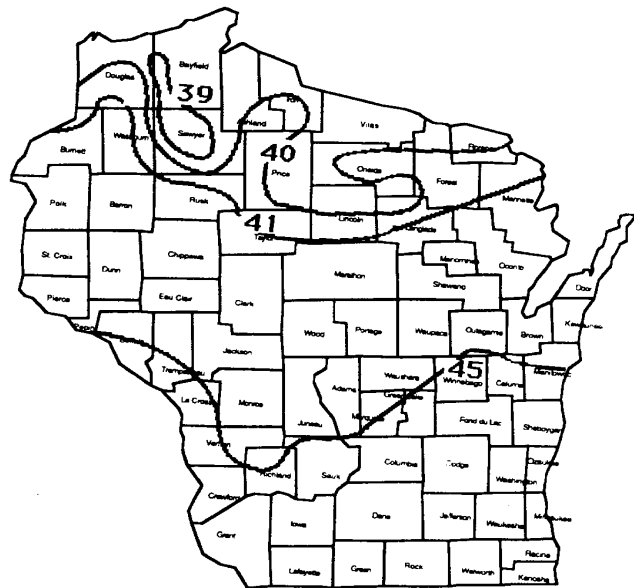

Mean Annual Temperature Contour Map

UDC Energy Worksheet

The UDC Energy Worksheet is required to be submitted with building plans for plan review prior to issuance of a building permit. Following is a sample dwelling and completed Energy Worksheet and a blank worksheet after that. **The sample completed worksheet has been completed for both the Prescriptive Package and System Design Methods for demonstration purposes. Normally only one method is required to be completed for showing code compliance.**

Sample dwelling: Non-Electrically heated single-family dwelling located in Dane County (Zone 3). Has 1,500 square feet and 186 linear feet of perimeter building thermal envelope. Garage is not heated. Estimated infiltration rate is .3 air changes per hour. There will be 170 cfm of installed exhaust ventilation.

Gross Above-Foundation Walls:

Wall = 8.09' (97"-1/8") x 186 linear feet = 1,504 square feet	
Box sill = 0.81 feet (9-3/4 inches deep: sill, header, subfloor) x 186 linear feet = 151 square feet	
Wood 1 x 8-inch drop siding	R = 0.79
1-inch extruded polystyrene sheathing	R = 5
R13 batt insulation	R = 13
2 x 4 framing, 16 inches O.C.	R = 4.4
1/2-inch drywall finish	R = 0.56

Door area = 38 sq ft	
Insulated steel doors	U = 0.35

Windows:

Above-Foundation Windows - 150 sq ft	
Wood, low-E, argon-filled, double-pane with 1/2" air space, rated by NFRC	U = 0.35
Foundation wall window area = 20 square feet	
Operable metal w/o thermal break, double pane	U = 0.87

Foundation - 8 ft high, 1 ft exposed	
8-inch poured concrete	R = 0.8
1-inch extruded polystyrene for full height	R = 5

Ceiling - 1,500 square feet, standard roof trusses (no raised heel)	
2 x 4 trusses, 24 inches O.C.	R = 4.4
Blown fiberglass insulation	R/inch = 2.5
Insulation in cavity, 16 inches	R = 40
Insulation over framing, 12.5 inches	R = 31.25
5/8-inch drywall finish	R = 0.56

Heating Plant

Gas-Fired Hot Air, 90% AFUE

High Efficiency

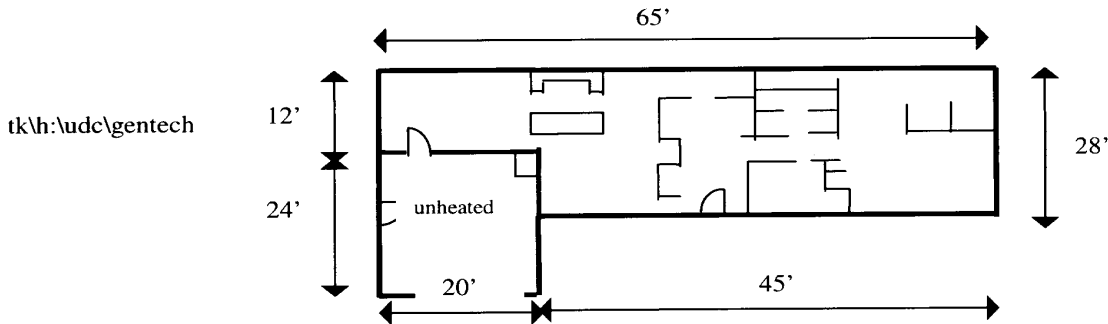

Submit completed worksheet pages 3-6 with dwelling plans to local enforcing municipality.

Project Address: Sample - Zone 3

Builder: _____ Owner: _____

Worksheet Completed By: _____ Date: _____

Does dwelling unit have three kilowatts or more input capacity of permanently installed electrical space heating equipment?
 YES (see below) NO

You will need to apply the stricter standards shown for electrically-heated homes if you answered "YES" to the above question.

A. Area Calculations

Enter appropriate dimensions to obtain area values. Some calculations will not be necessary depending on home design or calculation method. These calculated areas are referenced elsewhere on this worksheet, for example, "(A.1.)".

<p>1. Window, Skylight & Patio Door Area (overall unit area) a. In Above- Foundation Walls b. In Foundation Walls</p> <p style="text-align: center;">150 sq. ft. 20 sq. ft.</p> <p>c. Total (a. + b.) = 170</p>	<p>2. Opaque Door Area a. In Above- Foundation Walls b. In Foundation Walls</p> <p style="text-align: center;">38 sq. ft. 0 sq. ft.</p> <p>c. Total (a. + b.) = 38</p>
<p>3. Gross Exposed Basement Wall Area</p> <p style="text-align: center;">1' x 186'</p> <p style="text-align: right;">186 sq. ft.</p>	<p>4. Basement Wall Area Below Grade</p> <p style="text-align: center;">7' x 186'</p> <p style="text-align: right;">1302 sq. ft.</p>
<p>5. Opaque [1] Basement Wall Area (A.3. + A.4. - A.1.b.- A.2.b.)</p> <p style="text-align: center;">186 + 1302 - 20 - 0</p> <p style="text-align: right;">1468 sq. ft.</p> <p>If the exposed area of A.3. is greater than the below grade area of A.4., add A.5. to A.7 and cross out the number in this cell.</p>	<p>6. Gross Heated Above-Foundation Wall Area, including boxesill</p> <p style="text-align: center;">1504 + 151</p> <p style="text-align: right;">1655 sq. ft.</p>
<p>7. Above Foundation Code Wall Area (A.6. + A1.b. + A.2.b.)</p> <p style="text-align: center;">1655 + 20 + 0</p> <p style="text-align: right;">1675 sq. ft.</p>	<p>8. Opaque [1] Above-Foundation Wall Area (A.6. - A1.a. - A.2.a.)</p> <p style="text-align: center;">1655 - 150 - 38</p> <p style="text-align: right;">1467 sq. ft.</p>
<p>9. Floor Area Over Interior Unconditioned Spaces Less Than 50°</p> <p style="text-align: center;">0 sq. ft.</p>	<p>10. Insulated Roof Or Ceiling (less skylights)</p> <p style="text-align: center;">28 x 45 = 1260 12 x 20 = 240</p> <p style="text-align: right;">1500 sq. ft.</p>
<p>11. Exterior Floor Area (Overhangs)</p> <p style="text-align: center;">0 sq. ft.</p>	<p>12. Crawl Space Wall Area</p> <p style="text-align: right;">0 sq. ft.</p>
<p>13. Slab On Grade (above or less than 12 inches below grade)</p> <p style="text-align: center;">0 lineal feet of slab perimeter</p>	<p>14. Total Heated Envelope Area (A.5 + A.7 + A.9 + A.10 + A.11 + A.12 + (A.13. X 2'))</p> <p style="text-align: center;">1468 + 1675 + 0 + 1500 + 0 + 0 + 0</p> <p style="text-align: right;">4643 sq. ft.</p>
<p>15. Percent Glazing (for Prescriptive Package Method, Section B, only) (A.1.c. ÷ A.7. X 100%)</p> <p style="text-align: center;">170 ÷ 1675 x 100%</p> <p style="text-align: right;">10.2 %</p>	<p>16. Windows Description - Above-Foundation Windows: Frame type: <input checked="" type="checkbox"/> Wood or Wood Clad <input type="checkbox"/> Vinyl <input type="checkbox"/> Metal Glazing type: <input checked="" type="checkbox"/> Dual <input type="checkbox"/> Triple <input type="checkbox"/> Dual w/storm panel Dual-Glazing Air Space: <input type="checkbox"/> 1/4' <input type="checkbox"/> 3/8" <input checked="" type="checkbox"/> 1/2" or more Features: <input checked="" type="checkbox"/> Low-E <input checked="" type="checkbox"/> Argon-filled <input type="checkbox"/> Suspended film Foundation Windows: <input type="checkbox"/> Vinyl <input checked="" type="checkbox"/> Metal</p>

B. Prescriptive Package Method (Skip this section if using the System Design Method of Sections C-F)

The prescriptive package method is the simplest method for determining compliance with the UDC insulation and window requirements. To use the prescriptive package method, enter your actual design values in the "Actual" row below. For a component, with two or more areas of different insulation levels, such as windows, either use the least insulating value for both areas or use the Weighted Average tables below. Multiply your % glazing by the glazing U-value to obtain your "Glazing Factor". Find the Prescriptive Table that applies to your space heating fuel and sheathing type. Select a package from the table that most closely matches the construction indicated on your plans. Do not exceed the package U-values or glazing factor or fall below the package R-values with your design. Transfer the R-Values and U-values to the blank table below in the "Allowed" row. Then proceed to Section F. See page 2 for detailed instructions for this section.

	Package #	% glazing	U glazing	Glazing Factor (% glazing × U glazing)	R wall	R ceiling	R Bsm Crawl Space, Slab or Floor	U door	U overall	Equip. Eff.
Actual	-----	10.2 % (A.15)	0.41	0.042	R13 + 5	R40	R5	0.35	-----	High
Allowed	45	-----	-----	0.0504 Max	R18, 1 Min	R40 Min	R5 Min	0.35 Max	0.086	High

(Please go to Section F.)

Optional R-Value/U-Value Weighted Average Table for Component: Windows

Component Construction Description	R Value	U-Value (1÷R Value)	Area (sq ft)	U-Value × Area (UA)
Basement windows		0.87	20	17.4
Above-foundation windows		0.35	150	52.5
			Total Area = 170	Total UA = 69.9

$$\frac{69.9}{(\text{Total UA})} \div \frac{170}{(\text{Total Area})} = \frac{0.41}{(\text{Weighted Average U-Value (for windows or doors)})}$$

$$\frac{\quad}{(\text{Total Area})} \div \frac{\quad}{(\text{Total UA})} = \frac{\quad}{(\text{Weighted Average R-Value (for all other components)})}$$

Optional R-Value/U-Value Weighted Average Table for Component:

Component Construction Description	R Value	U-Value (1÷R Value)	Area (sq ft)	U-Value × Area (UA)
			Total Area =	Total UA =

$$\frac{\quad}{(\text{Total UA})} \div \frac{\quad}{(\text{Total Area})} = \frac{\quad}{(\text{Weighted Average U-Value (for windows or doors)})}$$

$$\frac{\quad}{(\text{Total Area})} \div \frac{\quad}{(\text{Total UA})} = \frac{\quad}{(\text{Weighted Average R-Value (for all other components)})}$$

Because the sample house fit a Package, you would normally skip ahead to Section F. For demonstration purposes here, the System Design Method is also completed.

C. Code-Allowed Heat Loss For System Design Method

Enter area values from Section A as notated and temperature differences per footnote 2 into this table and then multiply across by the electric or non-electric code-required U-value. Total the right column to find the total allowed heat loss factor.

Component	Area From Sect A.	× Required U-Value		= Heat Loss UA
		<input checked="" type="checkbox"/> NON-ELEC	<input type="checkbox"/> ELECTRIC	
1. Opaque Basement Wall [2]	1468 (A.5.)	0.077 [3]	0.077 [3]	113
2. Above Foundation Code Wall	1675 (A.7.)	0.110	0.080	184
3. Floor Over Interior Unconditioned Space	(A.9.)	0.050	0.050	
4. Roof or Ceiling	1500 (A.10.)	0.026	0.020	39
5. Floor Over Exterior	(A.11.)	0.033	0.033	
6. Crawl Space Wall	(A.12.)	0.060	0.060	
7. Slab On Grade <input type="checkbox"/> Unheated <input type="checkbox"/> Heated [3]	(A.13.) Lin. ft.	0.72 'F'	0.68 'F'	
8. Subtotal		0.70 'F'	0.68 'F'	336
9. Credit for High Efficiency Heating Plant: 1.18 for furnace or boiler >90% AFUE; 1.15 for heat pump > 7.8 HPSF, Otherwise use 1.0				× 1.18
10.		Total Code-Allowed Heat Loss Factor		396.5

D. System Design Method - Actual 'U' Values Of Your Home's Components

D.1. Above-Foundation Components - If applicable, check the appropriate typical component constructions listed below, and use the pre-calculated U values. If your wall construction is not listed, you may obtain a pre-calculated U value from the default U-Value tables in the UDC Appendix. (Note that the default Table 2 Wood Frame U-values assume no insulating sheathing which penalizes you if your wall does have insulating sheathing, then you may need to use the Manual Calculation section below.) If you are using exterior metal framing, then you must use the Metal-Frame Wall U-Values of the UDC Appendix. If your component construction is not listed here or in the default tables, you need to use the Manual Calculation section below to manually enter R-values for the different layers of building materials from the Typical Thermal Properties of Building Materials Table of the UDC Appendix, ASHRAE Fundamentals Manual or manufacturer's specifications. Total them across and then obtain the U-value by taking the reciprocal (1/R) of the total R-value.

Above-Foundation Walls	<input type="checkbox"/> 2X4, 16" O.C., R-13 batt, R-1 board: U - .079	<input type="checkbox"/> 2X4, 16" O.C., R-13 batt, R-5 board: U - .061									
	<input type="checkbox"/> 2X6, 16" O.C., R-19 batt, R-1 board: U - .059	<input type="checkbox"/> 2X6, 16" O.C., R-19 batt, R-5 board: U - .049									
<input type="checkbox"/> Other - describe:	U - _____ from Default Table										
Roof or Ceiling	<input type="checkbox"/> 2X4 truss, 24" O.C., with R-38 insulation: U - .030	<input type="checkbox"/> 2X4 truss, 24" O.C., with R-52 insulation: U - .025									
	<input type="checkbox"/> 2X12 cathedral ceiling, 16" O.C., with R-38 insulation	U - .027									
<input checked="" type="checkbox"/> Other - describe: R40 with regular trusses	U - 0.029 from Default Table 1										
Floor Over Exterior or Unconditioned Space	<input type="checkbox"/> 2X10 joists, 16" O.C., R-19 batt: U - .047	U - _____ from Default Table									
<input type="checkbox"/> Other - describe:	U - _____ from Default Table										
Optional Manual U-Value Calculation (if assembly not listed above)											
Component Name	Cavity Or Solid If Applicable	Ext. Air Film*	Ext. Finish	Insulation Over Framing	Sheathing	Framing Or Solid	Insulation Within Cavity	Interior Finish	Int. Air Film*	Total R-Value	U-Value
Above Foundation Wall	Cavity	.17	0.79	5.0		-----	13	0.56	.68	20.2	.050
	Solid	.17	0.79	5.0		4.4	-----	0.56	.68	11.6	.086
	Cavity					-----					
	Solid					-----					

*** Air Film R-Values**

Location	Heat Flow Direction		
	Upwards	Horizontal	Downwards
Exterior	.17	.17	.17
Interior	.61	.68	.92

D.2. Foundation And Slab-On-Grade Components - Check appropriate boxes for planned type of construction to determine pre-calculated overall 'U-value' including air films, wall, insulation, soil and cavity/solid differences. Slab on grade F-values are per lineal foot of slab perimeter.

Component Type	U-Value	
	Basement	Crawl Space
Foundation Wall		
<input type="checkbox"/> Masonry or concrete wall without insulation	0.360	0.477
<input checked="" type="checkbox"/> Masonry or concrete wall with R-5 insulation board for full height	0.115	0.136
<input type="checkbox"/> Masonry or concrete wall with R-10 insulation board or R-11 insulation batt and 2X4's for full height	0.072	0.081
<input type="checkbox"/> Permanent wood foundation with R-19 batt for full height	0.054	0.059
<input type="checkbox"/> Basement or crawl space floor without insulation	0.025	0.025
<input type="checkbox"/> Basement floor with R-5 insulation	0.022	0.022
Slab-On-Grade (or within 12" of grade)	F-Value	
<input type="checkbox"/> Slab-on-grade without insulation	1.04	
<input type="checkbox"/> Slab-on-grade with R-5 insulation for 48" total horizontal and vertical application	0.74	
<input type="checkbox"/> Slab-on-grade with R-10 insulation board for 48" total application	0.68	

D.3. Windows And Doors - Use manufacturer's specifications for window and glazed door values, if they were determined per NFRC Std 100, to enter into Table E. Otherwise see default tables of UDC s. Comm 22.05 for U-values.

E. System Design Method - Calculated Envelope Heat Loss Factor Of Your Home

Enter values into table from elsewhere on this worksheet and multiply across to find the actual heat loss factor of each component. If using pre-calculated component U-values, do not calculate separate cavity and solid figures or apply wood frame factors. Total component heat loss factors in right column to find total envelope heat loss factors.

Component	Cavity Or Solid If Applicable	Area From Sect. A	× Wood Frame Factor**	× Actual 'U' Value From Sect. D	= Heat Loss Factor (UA)
Above-Foundation Windows	-----	150 (A.1.a)	-----	0.35	52.5
Foundation Windows	-----	20 (A.1.b)	-----	0.87	17.4
Doors	-----	38 (A.2.c)	-----	0.35	13.3
Opaque Basement Wall	-----	1468 (A.5.)	-----	0.115	168.8
Opaque Above-Foundation Wall	Cavity	1467 (A.8.)	.75	.050	55
	Solid		.25	.086	31.5
Floor Over Unconditioned Spaces	Cavity	(A.9.)			
	Solid				
Roof or Ceiling	Cavity	1500 (A.10.)	-----	-----	-----
	Solid		-----	0.029	43.5
Floor Over Exterior	Cavity	(A.11.)			
	Solid				
Crawl Space Wall	-----	(A.12.)	-----		
Slab On Grade	-----	(A.13.)Lin. ft.	-----	F-Value	
Total Calculated Envelope Heat Loss Factor- Not to exceed Total Code Allowed Heat Loss Factor of line 10 of Section C. (Enter here: 396.5) by more than 1%					382

** Adjustment Factors For Wood-Framed Components - Do not apply if your are using a pre-calculated or default U-Value.

Spacing Of Framing Members	Stud Walls		Joists/Rafters	
	Cavity	Solid	Cavity	Solid
12"	.70	.30	.86	.14
16"	.75	.25	.90	.10
24"	.78	.22	.93	.07

F. Heat Loss Factor Due to Air Infiltration (for heating equipment sizing)

Enter appropriate values. A maximum infiltration air change rate of 0.5 per hour is allowed in addition to ventilation losses.

Floor Level	Area (sq ft)	× Height (ft)	Fan Capacity (cfm)	× Constant	× Air Changes Per Hour	= Heat Loss Factor(UA)
Basement	1500	8	-----	.018	0.3	64.8
Level 1	1500	8	-----	.018	0.3	64.8
Level 2			-----	.018		
Level 3			-----	.018		
Ventilation	-----	-----	170	.432	-----	73.4
Total Infiltration & Ventilation Heat Loss Factor						203

G. Heating Equipment Sizing

Enter appropriate value to determine the maximum and minimum allowable heating equipment capacity in BTUs/HR. A more detailed calculation may be submitted to the local code official. [4]

Prescriptive Package Method:	$\frac{0.086}{U \text{ overall from selected Prescriptive Package of Section B}}$	×	$\frac{4643}{\text{Total Envelope Area (A.14.)}}$	=	399.3
OR System Design Method: Calculated Heat Loss Factor from Sect. E.					
Infiltration & Ventilation Heat Loss Factor (from Sect. F.)					+ 203
Total Heat Loss Factor (UA)					= 602.3
Temperature Difference from Zone Table on page 1					× 85
Minimum Heating Equipment Output					= 51,196
Allowable Heating Equipment Size Margin Multiplier					× 1.15
Maximum Allowable Heating Equipment Output [5]					= 58,875
Planned Furnace Output Or Boiler IBR Rating					60,000
Make & Model if High Efficiency Credit has been taken: Acme XLH60K					

Prescriptive Package Tables (Corrected)

(See notes on page 2 of Energy Worksheet; I = insulating sheathing, RT = raised heel roof truss)

Table B-1 Prescriptive packages, Non-electric Heat, Structural Sheathing only

Package	Glazing Factor	R wall	R ceiling	R basement	U door	U overall	HVAC Equipment Efficiency
1	0.0370	R21	R42	R7	0.35	0.073	Normal
2	0.0264	R21	R51, RT	R5	0.35	0.073	Normal
3	0.0333	R15	R42	R10	0.35	0.073	Normal
4	0.0440	R19	R33	R10	0.35	0.073	Normal
5	0.0330	R13	R42	R11	0.35	0.073	Normal
6	0.0480	R19	R33	R11	0.35	0.073	Normal
7	0.0600	R21	R47	R11	0.35	0.073	Normal
8	0.0407	R13	R44	R13	0.35	0.073	Normal
9	0.0600	R19	R42	R13	0.35	0.073	Normal
10	0.0680	R21	R38, RT	R13	0.35	0.073	Normal
11	0.0296	R13	R49	R5	0.35	0.086	High
12	0.0440	R19	R30	R5	0.35	0.086	High
13	0.0520	R21	R33	R5	0.35	0.086	High
14	0.0720	R13	R47	R10	0.35	0.086	High
15	0.0784	R19	R38	R10	0.47	0.086	High
16	0.0640	R13	R33	R11	0.47	0.086	High
17	0.0896	R19	R49	R11	0.35	0.086	High
18	0.0896	R21	R34	R11	0.35	0.086	High
19	0.0920	R19	R34	R11	0.47	0.086	High
20	0.0840	R13	R49	R13	0.35	0.086	High
21	0.0840	R19	R30	R13	0.47	0.086	High
22	0.0896	R21	R31	R13	0.47	0.086	High
Package	Glazing Factor	R wall	R ceiling	R crawl	U door	U overall	HVAC Equipment Efficiency
23	0.0520	R19	R34	R19	0.47	0.070	Normal
24	0.0672	R13	R36	R19	0.47	0.083	High
25	0.0720	R13	R33	R19	0.47	0.083	High
Package	Glazing Factor	R wall	R ceiling	R slab	U door	U overall	HVAC Equipment Efficiency
26	0.0560	R21	R36	R5	0.47	0.103	Normal
27	0.0728	R13	R36	R5	0.47	0.121	High
28	0.0760	R13	R34	R5	0.47	0.121	High
Package	Glazing Factor	R wall	R ceiling	R heated-slab	U door	U overall	HVAC Equipment Efficiency
29	0.0560	R21	R47	R5	0.47	0.101	Normal
30	0.0728	R13	R42	R5	0.47	0.120	High
31	0.0760	R13	R38	R5	0.47	0.120	High
Package	Glazing Factor	R wall	R ceiling	R floor	U door	U overall	HVAC Equipment Efficiency
32	0.0480	R19	R47	R19	0.35	0.065	Normal
33	0.0728	R19	R36	R19	0.47	0.077	High
34	0.0560	R13	R34	R19	0.47	0.077	High

Table B-2 Prescriptive packages, Non-electric Heat, Insulating Sheathing

Package	Glazing Factor	R wall	R ceiling	R basement	U door	U overall	HVAC Equipment Efficiency
35	0.0370	R20, I	R42	R7	0.35	0.073	Normal
36	0.0363	R28, I	R38, RT	R5	0.35	0.073	Normal
37	0.0552	R18, I	R44	R10	0.35	0.073	Normal
38	0.0560	R20, I	R47	R10	0.35	0.073	Normal
39	0.0560	R23, I	R34	R10	0.35	0.073	Normal
40	0.0560	R18, I	R47	R11	0.35	0.073	Normal
41	0.0616	R23, I	R42	R11	0.35	0.073	Normal
42	0.0546	R18, I	R44	R11	0.35	0.073	Normal
43	0.0672	R23, I	R40	R13	0.35	0.073	Normal
44	0.0720	R25, I	R36	R13	0.35	0.073	Normal
45	0.0504	R18, I	R40	R5	0.35	0.086	High
46	0.0560	R19, I	R47	R5	0.35	0.086	High
47	0.0560	R23, I	R38	R5	0.47	0.086	High
48	0.0600	R25, I	R38	R5	0.47	0.086	High
49	0.0680	R26, I	R42	R5	0.35	0.086	High
50	0.0680	R28, I	R47	R5	0.47	0.086	High
51	0.0672	R26, I	R47	R5	0.35	0.086	High
52	0.0672	R28, I	R38	R5	0.35	0.086	High
53	0.0720	R20, I	R42	R7	0.47	0.086	High
54	0.0855	R18, I	R36	R11	0.35	0.086	High

Wisconsin Uniform Dwelling Code Energy Worksheet

Instructions: This worksheet is a Safety & Buildings Division (S&BD)-approved method of manually showing compliance with the energy conservation and heating equipment sizing requirements of the Uniform Dwelling Code (UDC), for new dwelling permits **submitted on or after February 1, 1999**. It may be necessary for the user to purchase a copy of the UDC from State Document Sales, (608)266-3358. Additional information is printed in the UDC Commentary, which is available for a fee, as are blank copies of this form, from S&BD at POB 2509, Madison, WI 53701, Tel. 608-267-4405. **Earlier editions of this worksheet may NOT be used.** Numbers in brackets, [1], refer to the footnotes printed on page 2.

You may also submit completed worksheets from the computer program *WIScheck*, which is available for free download from <http://www.energycodes.org/> on the Internet.

A required U-value is the **maximum** acceptable heat transmittance for an element. A required insulation R-value is the **minimum** acceptable level of resistance to heat transmittance. (U-values and R-values are reciprocals of each other.) If a component includes two or more areas of different insulation levels, either use the less insulating value for both areas, or use the Optional Weighted Average table in the **Prescriptive Package Method** section or enter separate areas and insulation values in the **System Design Method**. All "U" values must be carried to four places after the decimal point, rounded to three places. Other values may be rounded to the whole number.

Window and door U-values must be tested and documented by the manufacturer in accordance with the National Fenestration Rating Council (NFRC) test procedures or be taken from the glazing U-value table in s. Comm 22.05. Center-of-glass U-values cannot be used. If a door contains glass and an aggregate U-value rating for that door is not available, include the glass area of the door with your windows and use the opaque door U-value to determine compliance of the door.

The code gives credit for **high-efficiency heating equipment**. "High-Efficiency" means a furnace with an AFUE of 90% or more, or a heat pump with an HSPF of 7.8 or more without the use of electric resistance backup heat of greater than 3 kilowatts. If you plan to install more than one piece of heating equipment, the equipment with the lowest efficiency must exceed the efficiency required by the selected package.

Choice of Method: You have the choice of using the Prescriptive Package Method or the System Design Method to show code compliance. For the simpler **Prescriptive Package Method**, which is recommended for standard designs, complete Sections **A., B., F., and G.** Instructions are on page 2. You will be first calculating component areas, then comparing your planned insulation levels to the required insulation levels of the Prescriptive Packages. You will then calculate infiltration and ventilation heat losses to size your heating equipment. If you cannot comply with one of the prescriptive packages, you may be able to show compliance by the System Design Method.

For the **System Design Method**, which is recommended for alternative designs in which more insulation is installed in one component to offset less in another, complete **Sections A., C., D., E., F. and G.** You will be first calculating component areas, then a code-allowed heat loss factor, then component U- and R-values and then your calculated heat loss factor which you will compare to the code-allowed heat loss factor. You will then calculate infiltration and ventilation heat losses to size your heating equipment.

The **County Zone Table** below is use for determining the temperature difference for sizing your heating plant in Section G. You may submit to your local code official more exact calculations to size your heating equipment.

Zone 1 - 95 degrees	Zone 2 - 90 degrees	Zone 3 - 85 degrees	Zone 4 - 80 degrees
Ashland, Barron, Bayfield, Burnett, Chippewa, Douglas, Dunn, Florence, Forest, Iron, Lincoln, Oneida, Pierce, Polk, Price, Rusk, Saint Croix, Sawyer, Taylor, Vilas, Washburn	Adams, Buffalo, Clark, Eau Claire, Jackson, Juneau, LaCrosse, Langlade, Marathon, Marinette, Menominee, Monroe, Portage, Shawano, Oconto, Pepin, Trempeleau, Vernon, Waupaca, Wood	Brown, Calumet, Columbia, Crawford, Dane, Dodge, Door, Fond du Lac, Grant, Green, Green Lake, Iowa, Kewaunee, LaFayette, Manitowoc, Marquette, Outagamie, Richland, Sauk, Sheboygan, Waushara, Winnebago	Jefferson, Kenosha, Milwaukee, Ozaukee, Racine, Rock, Walworth, Washington, Waukesha

SBD-5518 (R. 12/98) Corr.

Detailed Instructions for Section B. Prescriptive Package Method:

R-value requirements are for insulation only and do not include structural components.

For a component with two or more areas of different insulation levels, either use the least insulating value for both areas or use the Weighted Average tables on page 4.

Wall R-values represent the sum of the wall cavity insulation plus insulating sheathing, if used. Do not include exterior siding, structural sheathing or interior drywall. For example, an R-20 requirement could be met *EITHER* by R-15 cavity insulation plus R-5 sheathing *OR* R-13 cavity insulation plus R-7 sheathing. Note that there are separate tables for walls with structural sheathing only and for walls with insulating sheathing. To use a table for insulating sheathing, the sheathing used must be at least R-4, except that at least R-2 insulation may be provided over corner bracing. Table wall R-Values apply to wood-frame or mass (concrete, masonry, log) wall assemblies, but not to metal-frame construction. If metal frame is planned, use the adjusted R-Values from the Metal-Frame Wall Tables of the UDC Appendix. Table wall values apply to boxsills.

Ceiling R-values represent the sum of the cavity insulation plus insulating sheathing, if used. For ventilated ceilings, any insulating sheathing must be placed between the conditioned space and the ventilated portion of the roof. Ceiling R-values with “**RT**” indicates that a raised-heel truss or oversized truss construction must be used so that the insulation achieves the full insulation thickness over the exterior walls.

Floor requirements apply to floors over unconditioned spaces (such as un-insulated crawlspaces, basements and garages). Floors over outside air shall have a $U_{\text{overall}} = 0.033$ or R-30 added insulation.

“**Heated-Slab**” requirements apply to slabs that contain heat ducts or pipes. All slab insulation must extend at least 48 inches either 1) down from the top of the slab, or 2) down from the top of the slab to the bottom of the slab and then horizontally underneath the slab, or 3) down from the top of the slab to the bottom of the slab and then horizontally away from the slab, with pavement or at least 10 inches of soil covering the horizontal insulation.

Walls of basements below un-insulated floors must be insulated from the top of the basement wall to the level of the basement floor. Conditioned basement windows and glass doors must be included with the other glazing. Exterior basement doors must meet the door U-value requirements. If more than 50% of the basement is exposed, then all of the basement walls must instead meet the above-foundation wall requirements.

Crawl space wall R-value requirements are for walls of unventilated crawlspaces. The crawlspace wall insulation must extend from the top of the wall (including the sill plate) to at least 12 inches below the outside finished grade. If the distance from the outside finished grade to the top of the footing is less than 12 inches, the insulation must extend a total vertical plus horizontal distance of 24 inches from the outside finished grade.

Footnotes for worksheet:

- [1] Opaque wall area is wall area minus opening areas of doors and windows.
- [2] These below-grade U-values have the insulating value of the soil added to the code-required U-values which apply to the building materials only. See Sect. D.2. for typical insulated component U-values.
- [3] These slab-on-grade F-values are derived from the code-required U-values and include the heat loss through the edge and body of the slab. See Sect. D.2. Temperature difference is the same as for above-grade spaces.
- [4] For building additions, show that the existing heating equipment, if used to heat the addition, is large enough. To do so, you must calculate the heat loss of the whole building.
- [5] If desired manufacturer does not have a furnace of this size, then a designer may select the manufacturer's next larger size.

Submit completed worksheet pages 3-6 with dwelling plans to local enforcing municipality.

Project Address: _____

Builder: _____ Owner: _____

Worksheet Completed By: _____ Date: _____

Does dwelling unit have three kilowatts or more input capacity of permanently installed electrical space heating equipment?
 YES (see below) NO

You will need to apply the stricter standards shown for electrically-heated homes if you answered "YES" to the above question.

A. Area Calculations

Enter appropriate dimensions to obtain area values. Some calculations will not be necessary depending on home design or calculation method. These calculated areas are referenced elsewhere on this worksheet, for example, "(A.1.)".

<p>1. Window, Skylight & Patio Door Area (overall unit area) a. In Above-Foundation Walls b. In Foundation Walls</p> <p>_____ sq. ft. _____ sq. ft.</p> <p>c. Total (a. + b.) = _____</p>	<p>2. Opaque Door Area a. In Above- Foundation Walls b. In Foundation Walls</p> <p>_____ sq. ft. _____ sq. ft.</p> <p>c. Total (a. + b.) = _____</p>
<p>3. Gross Exposed Basement Wall Area</p> <p>_____ sq. ft.</p>	<p>4. Basement Wall Area Below Grade</p> <p>_____ sq. ft.</p>
<p>5. Opaque [1] Basement Wall Area (A.3. + A.4. - A.1.b.- A.2.b.)</p> <p>_____ sq. ft.</p> <p>If the exposed area of A.3.is greater than the below grade area of A.4., add A.5. to A.7 and cross out the number in this cell.</p>	<p>6. Gross Heated Above-Foundation Wall Area, including boxesill</p> <p>_____ sq. ft.</p>
<p>7. Above Foundation Code Wall Area (A.6. + A1.b. + A.2.b.)</p> <p>_____ sq. ft.</p>	<p>8. Opaque [1] Above-Foundation Wall Area (A.6. - A1.a. - A.2.a.)</p> <p>_____ sq. ft.</p>
<p>9. Floor Area Over Interior Unconditioned Spaces Less Than 50°</p> <p>_____ sq. ft.</p>	<p>10. Insulated Roof Or Ceiling (less skylights)</p> <p>_____ sq. ft.</p>
<p>11. Exterior Floor Area (Overhangs)</p> <p>_____ sq. ft.</p>	<p>12. Crawl Space Wall Area</p> <p>_____ sq. ft.</p>
<p>13. Slab On Grade (above or less than 12 inches below grade)</p> <p>_____ lineal feet of slab perimeter</p>	<p>14. Total Heated Envelope Area (A.5 + A.7 + A.9 + A.10 +A.11 + A.12 +(A.13. × 2'))</p> <p>_____ sq. ft.</p>
<p>15. Percent Glazing (for Prescriptive Package Method, Section B, only) (A.1.c. ÷ A.7. × 100%)</p> <p>_____ %</p>	<p>16. Windows Description - Above-Foundation Windows: Frame type: <input type="checkbox"/> Wood or Wood Clad <input type="checkbox"/> Vinyl <input type="checkbox"/> Metal Glazing type: <input type="checkbox"/> Dual <input type="checkbox"/> Triple <input type="checkbox"/> Dual w/storm panel Dual-Glazing Air Space: <input type="checkbox"/> 1/4' <input type="checkbox"/> 3/8" <input type="checkbox"/> 1/2" or more Features: <input type="checkbox"/> Low-E <input type="checkbox"/> Argon-filled <input type="checkbox"/> Suspended film Foundation Windows: <input type="checkbox"/> Vinyl <input type="checkbox"/> Metal</p>

SBD-5518 (R. 12/98) Corr

B. Prescriptive Package Method (Skip this section if using the System Design Method of Sections C-F)

The prescriptive package method is the simplest method for determining compliance with the UDC insulation and window requirements. To use the prescriptive package method, enter your actual design values in the "Actual" row below. For a component, with two or more areas of different insulation levels, such as windows, either use the least insulating value for both areas or use the Weighted Average tables below. Multiply your % glazing by the glazing U-value to obtain your "Glazing Factor". Find the Prescriptive Table that applies to your space heating fuel and sheathing type. Select a package from the table that most closely matches the construction indicated on your plans. Do not exceed the package U-values or glazing factor or fall below the package R-values with your design. Transfer the R-Values and U-values to the blank table below in the "Allowed" row. Then proceed to Section F. See page 2 for detailed instructions for this section.

	Package #	% glazing	U glazing	Glazing Factor (% glazing × U glazing)	R wall	R ceiling	R Bsmt, Crawl Space, Slab or Floor	U door	U overall	Equip. Eff.
Actual	-----	%(A.15)							-----	
Allowed		-----	-----	Max	Min	Min	Min	Max		

(Please go to Section F.)

Optional R-Value/U-Value Weighted Average Table for Component:

Component Construction Description	R Value	U-Value (1÷R Value)	Area (sq ft)	U-Value × Area (UA)
			Total Area =	Total UA =

$$\frac{\text{(Total UA)}}{\text{(Total Area)}} \div \frac{\text{(Total Area)}}{\text{(Total UA)}} = \text{(Weighted Average U-Value (for windows or doors))}$$

$$\frac{\text{(Total Area)}}{\text{(Total Area)}} \div \frac{\text{(Total UA)}}{\text{(Total UA)}} = \text{(Weighted Average R-Value (for all other components))}$$

Optional R-Value/U-Value Weighted Average Table for Component:

Component Construction Description	R Value	U-Value (1÷R Value)	Area (sq ft)	U-Value × Area (UA)
			Total Area =	Total UA =

$$\frac{\text{(Total UA)}}{\text{(Total Area)}} \div \frac{\text{(Total Area)}}{\text{(Total UA)}} = \text{(Weighted Average U-Value (for windows or doors))}$$

$$\frac{\text{(Total Area)}}{\text{(Total Area)}} \div \frac{\text{(Total UA)}}{\text{(Total UA)}} = \text{(Weighted Average R-Value (for all other components))}$$

C. Code-Allowed Heat Loss For System Design Method

Enter area values from Section A as notated and temperature differences per footnote 2 into this table and then multiply across by the electric or non-electric code-required U-value. Total the right column to find the total allowed heat loss factor.

Component	Area From Sect A.	× Required U-Value		= Heat Loss UA
		<input type="checkbox"/> NON-ELEC	<input type="checkbox"/> ELECTRIC	
1. Opaque Basement Wall [2]	(A.5.)	0.077 [3]	0.077 [3]	
2. Above Foundation Code Wall	(A.7.)	0.110	0.080	
3. Floor Over Interior Unconditioned Space	(A.9.)	0.050	0.050	
4. Roof or Ceiling	(A.10.)	0.026	0.020	
5. Floor Over Exterior	(A.11.)	0.033	0.033	
6. Crawl Space Wall	(A.12.)	0.060	0.060	
7. Slab On Grade <input type="checkbox"/> Unheated <input type="checkbox"/> Heated [3]	(A.13.) Lin. ft.	0.72 'F' 0.70 'F'	0.68 'F' 0.68' F'	
8. Subtotal				
9. Credit for High Efficiency Heating Plant: 1.18 for furnace or boiler >90% AFUE; 1.15 for heat pump > 7.8 HPSF, Otherwise use 1.0				×
10.		Total Code-Allowed Heat Loss Factor		

D. System Design Method - Actual 'U' Values Of Your Home's Components

D.1. Above-Foundation Components - If applicable, check the appropriate typical component constructions listed below, and use the pre-calculated U values. If your wall construction is not listed, you may obtain a pre-calculated U value from the default U-Value tables in the UDC Appendix. (Note that the default Table 2 Wood Frame U-values assume no insulating sheathing which penalizes you if your wall does have insulating sheathing, then you may need to use the Manual Calculation section below.) If you are using exterior metal framing, then you must use the Metal-Frame Wall U-Values of the UDC Appendix. If your component construction is not listed here or in the default tables, you need to use the Manual Calculation section below to manually enter R-values for the different layers of building materials from the Typical Thermal Properties of Building Materials Table of the UDC Appendix, ASHRAE Fundamentals Manual or manufacturer's specifications. Total them across and then obtain the U-value by taking the reciprocal (1/R) of the total R-value.

Above-Foundation Walls		<input type="checkbox"/> 2X4, 16" O.C., R-13 batt, R-1 board: U - .079	<input type="checkbox"/> 2X4, 16" O.C., R-13 batt, R-5 board: U - .061								
		<input type="checkbox"/> 2X6, 16" O.C., R-19 batt, R-1 board: U - .059	<input type="checkbox"/> 2X6, 16" O.C., R-19 batt, R-5 board: U - .049								
<input type="checkbox"/> Other - describe:		U - from Default Table									
Roof or Ceiling		<input type="checkbox"/> 2X4 truss, 24" O.C., with R-38 insulation: U - .030	<input type="checkbox"/> 2X4 truss, 24" O.C., with R-52 insulation: U - .025								
		<input type="checkbox"/> 2X12 cathedral ceiling, 16" O.C., with R-38 insulation: U - .027									
<input type="checkbox"/> Other - describe:		U - from Default Table									
Floor Over Exterior or Unconditioned Space		<input type="checkbox"/> 2X10 joists, 16" O.C., R-19 batt: U - .047									
<input type="checkbox"/> Other - describe:		U - from Default Table									
Manual U-Value Calculation (if assembly not listed above)											
Component Name	Cavity Or Solid If Applicable	Ext. Air Film*	Ext. Finish	Insulation Over Framing	Sheathing	Framing Or Solid	Insulation Within Cavity	Interior Finish	Int. Air Film*	Total R-Value	U-Value
	Cavity					-----					
	Solid					-----					
	Cavity					-----					
	Solid					-----					

*** Air Film R-Values**

Location	Heat Flow Direction		
	Upwards	Horizontal	Downwards
Exterior	.17	.17	.17
Interior	.61	.68	.92

D.2. Foundation And Slab-On-Grade Components - Check appropriate boxes for planned type of construction to determine pre-calculated overall 'U-value' including air films, wall, insulation, soil and cavity/solid differences. Slab on grade F-values are per lineal foot of slab perimeter.

Component Type	U-Value	
	Basement	Crawl Space
Foundation Wall		
<input type="checkbox"/> Masonry or concrete wall without insulation	0.360	0.477
<input type="checkbox"/> Masonry or concrete wall with R-5 insulation board for full height	0.115	0.136
<input type="checkbox"/> Masonry or concrete wall with R-10 insulation board or R-11 insulation batt and 2X4's for full height	0.072	0.081
<input type="checkbox"/> Permanent wood foundation with R-19 batt for full height	0.054	0.059
<input type="checkbox"/> Basement or crawl space floor without insulation	0.025	0.025
<input type="checkbox"/> Basement floor with R-5 insulation	0.022	0.022
Slab-On-Grade (or within 12" of grade)	F-Value	
<input type="checkbox"/> Slab-on-grade without insulation	1.04	
<input type="checkbox"/> Slab-on-grade with R-5 insulation for 48" total horizontal and vertical application	0.74	
<input type="checkbox"/> Slab-on-grade with R-10 insulation board for 48" total application	0.68	

D.3. Windows And Doors - Use manufacturer's specifications for window and glazed door values, if they were determined per NFRC Std 100, to enter into Table E. Otherwise see default tables of UDC s. Comm 22.05 for U-values.

E. System Design Method - Calculated Envelope Heat Loss Factor Of Your Home

Enter values into table from elsewhere on this worksheet and multiply across to find the actual heat loss factor of each component. If using pre-calculated component U-values, do not calculate separate cavity and solid figures or apply wood frame factors. Total component heat loss factors in right column to find total envelope heat loss factors.

Component	Cavity Or Solid If Applicable	Area From Sect. A	× Wood Frame Factor**	× Actual 'U' Value From Sect. D	= Heat Loss Factor (UA)
Above-Foundation Windows	-----	(A.1.a.)	-----		
Foundation Windows	-----	(A.1.b)	-----		
Doors	-----	(A.2.c)	-----		
Opaque Basement Wall	-----	(A.5.)	-----		
Opaque Above-Foundation Wall	Cavity	(A.8.)			
	Solid				
Floor Over Unconditioned Spaces	Cavity	(A.9.)			
	Solid				
Roof or Ceiling	Cavity	(A.10.)			
	Solid				
Floor Over Exterior	Cavity	(A.11.)			
	Solid				
Crawl Space Wall	-----	(A.12.)	-----		
Slab On Grade	-----	(A.13.)Lin. ft.	-----	F-Value	
Total Calculated Envelope Heat Loss Factor- Not to exceed Total Code Allowed Heat Loss Factor of line 10 of Section C. (Enter here: _____) by more than 1%					

** Adjustment Factors For Wood-Framed Components - Do not apply if your are using a pre-calculated or default U-Value.

Spacing Of Framing Members	Stud Walls		Joists/Rafters	
	Cavity	Solid	Cavity	Solid
12"	.70	.30	.86	.14
16"	.75	.25	.90	.10
24"	.78	.22	.93	.07

F. Heat Loss Factor Due to Air Infiltration (for heating equipment sizing)

Enter appropriate values. A maximum infiltration air change rate of 0.5 per hour is allowed in addition to ventilation losses.

Floor Level	Area (sq ft)	× Height (ft)	Fan Capacity (cfm)	× Constant	× Air Changes Per Hour	= Heat Loss Factor(UA)
Basement			-----	.018		
Level 1			-----	.018		
Level 2			-----	.018		
Level 3			-----	.018		
Ventilation	-----	-----		.432	-----	
Total Infiltration & Ventilation Heat Loss Factor						

G. Heating Equipment Sizing

Enter appropriate value to determine the maximum and minimum allowable heating equipment capacity in BTUs/HR. A more detailed calculation may be submitted to the local code official. [4]

Prescriptive Package Method:	$\frac{U_{\text{overall from selected Prescriptive Package of Section B}} \times \text{Total Envelope Area (A.14.)}}{\text{Temperature Difference from County Zone Table on page 1}}$	=
OR System Design Method: Calculated Heat Loss Factor from Sect. E.		
Infiltration & Ventilation Heat Loss Factor (from Sect. F.)		+
Total Heat Loss Factor (UA)		=
Temperature Difference from County Zone Table on page 1		×
Minimum Heating Equipment Output		=
Allowable Heating Equipment Size Margin Multiplier		× 1.15
Maximum Allowable Heating Equipment Output [5]		=
Planned Furnace Output Or Boiler IBR Rating		
Make & Model if High Efficiency Credit has been taken:		

Prescriptive Package Tables (Corrected)

(See notes on page 2 of Energy Worksheet: I = insulating sheathing, RT = raised heel roof truss)

Table B-1 Prescriptive packages, Non-electric Heat, Structural Sheathing only

Package	Glazing Factor	R wall	R ceiling	R basement	U door	U overall	HVAC Equipment Efficiency
1	0.0370	R21	R42	R7	0.35	0.073	Normal
2	0.0264	R21	R51, RT	R5	0.35	0.073	Normal
3	0.0333	R15	R42	R10	0.35	0.073	Normal
4	0.0440	R19	R33	R10	0.35	0.073	Normal
5	0.0330	R13	R42	R11	0.35	0.073	Normal
6	0.0480	R19	R33	R11	0.35	0.073	Normal
7	0.0600	R21	R47	R11	0.35	0.073	Normal
8	0.0407	R13	R44	R13	0.35	0.073	Normal
9	0.0600	R19	R42	R13	0.35	0.073	Normal
10	0.0680	R21	R38, RT	R13	0.35	0.073	Normal
11	0.0296	R13	R49	R5	0.35	0.086	High
12	0.0440	R19	R30	R5	0.35	0.086	High
13	0.0520	R21	R33	R5	0.35	0.086	High
14	0.0720	R13	R47	R10	0.35	0.086	High
15	0.0784	R19	R38	R10	0.47	0.086	High
16	0.0640	R13	R33	R11	0.47	0.086	High
17	0.0896	R19	R49	R11	0.35	0.086	High
18	0.0896	R21	R34	R11	0.35	0.086	High
19	0.0920	R19	R34	R11	0.47	0.086	High
20	0.0840	R13	R49	R13	0.35	0.086	High
21	0.0840	R19	R30	R13	0.47	0.086	High
22	0.0896	R21	R31	R13	0.47	0.086	High
Package	Glazing Factor	R wall	R ceiling	R crawl	U door	U overall	HVAC Equipment Efficiency
23	0.0520	R19	R34	R19	0.47	0.070	Normal
24	0.0672	R13	R36	R19	0.47	0.083	High
25	0.0720	R13	R33	R19	0.47	0.083	High
Package	Glazing Factor	R wall	R ceiling	R slab	U door	U overall	HVAC Equipment Efficiency
26	0.0560	R21	R36	R5	0.47	0.103	Normal
27	0.0728	R13	R36	R5	0.47	0.121	High
28	0.0760	R13	R34	R5	0.47	0.121	High
Package	Glazing Factor	R wall	R ceiling	R heated-slab	U door	U overall	HVAC Equipment Efficiency
29	0.0560	R21	R47	R5	0.47	0.101	Normal
30	0.0728	R13	R42	R5	0.47	0.120	High
31	0.0760	R13	R38	R5	0.47	0.120	High
Package	Glazing Factor	R wall	R ceiling	R floor	U door	U overall	HVAC Equipment Efficiency
32	0.0480	R19	R47	R19	0.35	0.065	Normal
33	0.0728	R19	R36	R19	0.47	0.077	High
34	0.0560	R13	R34	R19	0.47	0.077	High

Table B-2 Prescriptive packages, Non-electric Heat, Insulating Sheathing

Package	Glazing Factor	R wall	R ceiling	R basement	U door	U overall	HVAC Equipment Efficiency
35	0.0370	R20, I	R42	R7	0.35	0.073	Normal
36	0.0363	R28, I	R38, RT	R5	0.35	0.073	Normal
37	0.0552	R18, I	R44	R10	0.35	0.073	Normal
38	0.0560	R20, I	R47	R10	0.35	0.073	Normal
39	0.0560	R23, I	R34	R10	0.35	0.073	Normal
40	0.0560	R18, I	R47	R11	0.35	0.073	Normal
41	0.0616	R23, I	R42	R11	0.35	0.073	Normal
42	0.0546	R18, I	R44	R11	0.35	0.073	Normal
43	0.0672	R23, I	R40	R13	0.35	0.073	Normal
44	0.0720	R25, I	R36	R13	0.35	0.073	Normal
45	0.0504	R18, I	R40	R5	0.35	0.086	High
46	0.0560	R19, I	R47	R5	0.35	0.086	High
47	0.0560	R23, I	R38	R5	0.47	0.086	High
48	0.0600	R25, I	R38	R5	0.47	0.086	High
49	0.0680	R26, I	R42	R5	0.35	0.086	High
50	0.0680	R28, I	R47	R5	0.47	0.086	High
51	0.0672	R26, I	R47	R5	0.35	0.086	High
52	0.0672	R28, I	R38	R5	0.35	0.086	High
53	0.0720	R20, I	R42	R7	0.47	0.086	High
54	0.0855	R18, I	R36	R11	0.35	0.086	High

55	0.0896	R23, I	R33	R11	0.47	0.086	High
56	0.0861	R18, I	R36	R13	0.47	0.086	High
57	0.1000	R23, I	R33	R13	0.47	0.086	High
Package	Glazing Factor	R wall	R ceiling	R crawl	U door	U overall	HVAC Equipment Efficiency.
58	0.0546	R18, I	R38	R19	0.47	0.070	Normal
59	0.0784	R15, I	R30	R19	0.47	0.083	High
60	0.0880	R15, I	R38	R19	0.47	0.083	High
Package	Glazing Factor	R wall	R ceiling	R slab	U door	U overall	HVAC Equipment Efficiency
61	0.0640	R23, I	R36	R5	0.47	0.103	Normal
62	0.0896	R15, I	R36	R5	0.47	0.121	High
63	0.0960	R15, I	R38	R5	0.47	0.121	High
Package	Glazing Factor	R wall	R ceiling	R heated-slab	U door	U overall	HVAC Equipment Efficiency
64	0.0640	R23, I	R34	R5	0.47	0.101	Normal
65	0.0840	R15, I	R31	R5	0.47	0.121	High
66	0.0920	R15, I	R33	R5	0.47	0.121	High
Package	Glazing Factor	R wall	R ceiling	R floor	U door	U overall	HVAC Equipment Efficiency
67	0.0480	R20, I	R44	R19	0.35	0.065	Normal
68	0.0728	R20, I	R36	R19	0.47	0.077	High
69	0.0560	R14, I	R38	R19	0.47	0.078	High

Table B-3 Prescriptive packages, Electric Heat, Structural Sheathing Only

Package	Glazing Factor	R wall	R ceiling	R basement	U door	U overall	HVAC Equipment Efficiency
E 70	0.0396	R21	R37, RT	R19	0.35	0.059	Normal
E 71	0.0429	R21	R42, RT	R19	0.35	0.059	Normal
E 72	0.0520	R21	R49	R13	0.35	0.068	High
E 73	0.0640	R19	R42, RT	R19	0.35	0.068	High
E 74	0.0693	R21	R49, RT	R19	0.47	0.068	High
Package	Glazing Factor	R wall	R ceiling	R crawl	U door	U overall	HVAC Equipment Efficiency
E 75	0.0429	R21	R54, RT	R30	0.35	0.054	Normal
E 76	0.0480	R21	R45, RT	R19	0.35	0.062	High
E 77	0.0627	R21	R54, RT	R30	0.47	0.062	High
Package	Glazing Factor	R wall	R ceiling	R slab	U door	U overall	HVAC Equipment Efficiency
E 78	0.0396	R26	R51, RT	R10	0.35	0.083	Normal
E 79	0.0480	R21	R49	R7	0.35	0.095	High
E 80	0.0528	R21	R49, RT	R5	0.35	0.095	High
Package	Glazing Factor	R wall	R ceiling	R floor	U door	U overall	HVAC Equipment Efficiency
E 81	0.0363	R21	R54, RT	R30	0.35	0.052	Normal
E 82	0.0520	R21	R49	R30	0.35	0.060	High
E 83	0.0528	R21	R44, RT	R30	0.47	0.060	High

Table B-4 Prescriptive packages, Electric Heat, Insulating Sheathing

Package	Glazing Factor	R wall	R ceiling	R basement	U door	U overall	HVAC Equipment Efficiency
E 84	0.0480	R25, I	R48, RT	R16	0.35	0.059	Normal
E 85	0.0495	R25, I	R48, RT	R16	0.35	0.059	Normal
E 86	0.0462	R28, I	R40	R16	0.35	0.059	Normal
E 87	0.0429	R25, I	R36	R18	0.35	0.059	Normal
E 88	0.0528	R23, I	R58, RT	R18	0.35	0.059	Normal
E 89	0.0462	R25, I	R42	R18	0.35	0.059	Normal
E 90	0.0560	R25, I	R46, RT	R10	0.35	0.068	High
E 91	0.0640	R23, I	R48, RT	R13	0.35	0.068	High
E 92	0.0600	R25, I	R42	R13	0.35	0.068	High
E 93	0.0600	R23, I	R37	R18	0.47	0.068	High
E 94	0.0759	R25, I	R46, RT	R18	0.47	0.068	High
Package	Glazing Factor	R wall	R ceiling	R crawl	U door	U overall	HVAC Equipment Efficiency
E 95	0.0429	R25, I	R48, RT	R23	0.35	0.054	Normal
E 96	0.0520	R23, I	R38	R23	0.35	0.062	High
E 97	0.0561	R25, I	R44	R23	0.47	0.062	High
Package	Glazing Factor	R wall	R ceiling	R slab	U door	U overall	HVAC Equipment Efficiency
E 98	0.0396	R25, I	R48, RT	R10	0.35	0.083	Normal
E 99	0.0560	R23, I	R44	R7	0.35	0.095	High
E 100	0.0594	R25, I	R46, RT	R5	0.47	0.095	High
Package	Glazing Factor	R wall	R ceiling	R floor	U door	U overall	HVAC Equipment Efficiency
E 101	0.0429	R25, I	R46, RT	R30	0.35	0.052	Normal
E 102	0.0560	R23, I	R44	R30	0.35	0.060	High
E 103	0.0627	R25, I	R44, RT	R30	0.47	0.060	High

Default Assembly R and U Value Tables

(All U-values include framing factors, finish materials and air films.)

Table 1. Ceiling U-Values^(a)

Insulation R-Value	Standard Truss U-Value	Raised Truss ^(b) U-Value	Insulation R-Value	Standard Truss U-Value	Raised Truss ^(b) U-Value
R-0	0.568	0.568	R-33	0.033	0.029
R-7	0.119	0.119	R-34	0.032	0.028
R-8	0.108	0.108	R-35	0.032	0.028
R-9	0.098	0.098	R-36	0.031	0.027
R-10	0.089	0.089	R-37	0.031	0.026
R-11	0.082	0.082	R-38	0.030	0.025
R-12	0.076	0.076	R-39	0.030	0.025
R-13	0.070	0.070	R-40	0.029	0.024
R-14	0.066	0.066	R-41	0.029	0.024
R-15	0.062	0.061	R-42	0.028	0.023
R-16	0.059	0.058	R-43	0.028	0.023
R-17	0.056	0.055	R-44	0.027	0.022
R-18	0.053	0.052	R-45	0.027	0.022
R-19	0.051	0.049	R-46	0.027	0.021
R-20	0.048	0.047	R-47	0.026	0.021
R-21	0.047	0.045	R-48	0.026	0.020
R-22	0.045	0.043	R-49	0.026	0.020
R-23	0.043	0.041	R-50	0.026	0.020
R-24	0.042	0.040	R-51	0.025	0.019
R-25	0.040	0.038	R-52	0.025	0.019
R-26	0.039	0.037	R-53	0.025	0.019
R-27	0.038	0.035	R-54	0.025	0.018
R-28	0.037	0.034	R-55	0.024	0.018
R-29	0.036	0.033	R-56	0.024	0.018
R-30	0.035	0.032	R-57	0.024	0.018
R-31	0.034	0.031	R-58	0.024	0.017
R-32	0.034	0.030	R-59	0.024	0.017

(a) R-values represent the sum of the ceiling cavity insulation plus the R-value of insulating sheathing (if used). For example, R-19 cavity insulation plus R-2 sheathing is reported as R-21 ceiling insulation. For ventilated ceilings, insulating sheathing must be placed between the conditioned space and the ventilated portion of the roof (typically applied to the trusses or rafters immediately behind the drywall or other ceiling finish material).

(b) To receive credit for a raised truss, the insulation must achieve its full insulation thickness over the exterior walls.

Table 2. Wood-Frame Wall U-Values^(a,b)

Insulation R-Value^(c)	16-in. O.C. Wall U-Value	24-in. O.C. Wall U-Value
R-0	0.238	0.241
R-7	0.105	0.104
R-8	0.099	0.097
R-9	0.094	0.092
R-10	0.090	0.088
R-11	0.089	0.087
R-12	0.085	0.083
R-13	0.082	0.080
R-14	0.079	0.077
R-15	0.077	0.074
R-16	0.066	0.064
R-17	0.064	0.062
R-18	0.062	0.060
R-19	0.060	0.059
R-20	0.059	0.057
R-21	0.057	0.056
R-22	0.056	0.054
R-23	0.055	0.053
R-24	0.054	0.052
R-25	0.053	0.051
R-26	0.052	0.050
R-27	0.051	0.049
R-28	0.050	0.048

(a) U-values are for uncompressed insulation.

(b) U-values in this Table were developed for wood-frame walls, but the 16-in. O.C. Wall U-Value column can also be used for above-grade concrete, masonry, and log walls. Mass wall R-value to U-value conversion tables are planned for future versions of the MECcheck Manual. TM

(c) Wall R-values are the sum of the cavity insulation plus insulating sheathing (if used).

Table 3. 16-in. O.C. Metal-Frame Wall U-Values and Equivalent Prescriptive Package Wall R-Values (Use the U-values below for the System Design Method of the Energy Worksheet. Use the equivalent R-value below to choose an Energy Worksheet Prescriptive Package with a wall R-value that is less than or equal to it. If you have an equivalent R-value without an "I" listed after it, then you must use a Package wall R-value without an "I" designation.)

Cavity R-Value	Insulating Sheathing R-Value										
	R-0	R-1	R-2	R-3	R-4	R-5	R-6	R-7	R-8	R-9	R-10
R-0	U-0.270	U-0.258	U-0.205	U-0.170	U-0.146	U-0.127	U-0.113	U-0.101	U-0.092	U-0.084	U-0.078
R-11	U-0.120	U-0.118	U-0.106	U-0.096	U-0.087	U-0.080	U-0.074 R15	U-0.069 R15I	U-0.065 R16I	U-0.061 R18I	U-0.057 R20I
R-13	U-0.114	U-0.111	U-0.100	U-0.091	U-0.084	U-0.077 R15	U-0.072 R15	U-0.067 R15I	U-0.063 R17I	U-0.059 R19I	U-0.056 R22I
R-15	U-0.109	U-0.107	U-0.096	U-0.088	U-0.081	U-0.075 R15	U-0.070 R15	U-0.065 R16I	U-0.061 R18I	U-0.058 R19I	U-0.054 R22I
R-19	U-0.101	U-0.099	U-0.090	U-0.083	U-0.077 R15	U-0.071 R15	U-0.066 R15I	U-0.062 R17I	U-0.059 R19I	U-0.055 R20I	U-0.052 R22I
R-21	U-0.098	U-0.096	U-0.088	U-0.081 R13	U-0.075 R15	U-0.070 R15	U-0.065 R16I	U-0.061 R18I	U-0.058 R19I	U-0.054 R20I	U-0.052 R22I
R-25	U-0.094	U-0.093	U-0.085	U-0.078 R13	U-0.073 R15	U-0.068 R15I	U-0.063 R17I	U-0.060 R19I	U-0.056 R20I	U-0.053 R20I	U-0.051 R23I

Table 4. 24-in. O.C. Metal-Frame Wall U-Values and Equivalent Prescriptive Package Wall R-Values (Use the U-values below for the System Design Method of the Energy Worksheet. Use the equivalent R-value below to choose an Energy Worksheet Prescriptive Package with a wall R-value that is less than or equal to it. If you have an equivalent R-value without an "I" listed after it, then you must use a Package wall R-value without an "I" designation.)

Cavity R-Value	Insulating Sheathing R-Value										
	R-0	R-1	R-2	R-3	R-4	R-5	R-6	R-7	R-8	R-9	R-10
R-0	U-0.270	U-0.258	U-0.205	U-0.170	U-0.146	U-0.127	U-0.113	U-0.101	U-0.092	U-0.084	U-0.078 R13
R-11	U-0.106	U-0.104	U-0.095	U-0.086	U-0.080 R13	U-0.074 R15	U-0.069 R15I	U-0.064 R17I	U-0.060 R18I	U-0.057 R20I	U-0.054 R20I
R-13	U-0.100	U-0.098	U-0.090	U-0.082 R13	U-0.076 R15	U-0.071 R15	U-0.066 R15I	U-0.062 R17I	U-0.058 R19I	U-0.055 R20I	U-0.052 R22I
R-15	U-0.094	U-0.093	U-0.085	U-0.078 R13	U-0.073 R15	U-0.068 R15I	U-0.063 R17I	U-0.060 R19I	U-0.056 R20I	U-0.053 R20I	U-0.051 R23I
R-19	U-0.088	U-0.086	U-0.080 R13	U-0.074 R15	U-0.069 R15I	U-0.064 R17I	U-0.060 R19I	U-0.057 R20I	U-0.054 R20I	U-0.051 R23I	U-0.049 R24I
R-21	U-0.085	U-0.084	U-0.077 R15	U-0.072 R15	U-0.067 R15I	U-0.063 R17I	U-0.059 R19I	U-0.056 R20I	U-0.053 R20I	U-0.050 R23I	U-0.048 R24I
R-25	U-0.081 R13	U-0.080 R13	U-0.074 R15	U-0.069 R15	U-0.064 R17I	U-0.060 R19I	U-0.057 R20I	U-0.054 R20I	U-0.051 R23I	U-0.049 R23I	U-0.046 R24I

Table 5. Floor U-Values

Insulation R-Value	Floor U-Value
R-0	0.249
R-7	0.096
R-11	0.072
R-13	0.064
R-15	0.057
R-19	0.047
R-21	0.044
R-26	0.037
R-30	0.033

Table 6. Basement U-Values^(a)

Insulation R-Value	Basement Wall U-Value	Insulation R-Value	Basement Wall U-Value
R-0	0.360	R-10	0.072
R-1	0.244	R-11	0.067
R-2	0.188	R-12	0.062
R-3	0.155	R-13	0.059
R-4	0.132	R-14	0.055
R-5	0.115	R-15	0.052
R-6	0.102	R-16	0.050
R-7	0.092	R-17	0.047
R-8	0.084	R-18	0.045
R-9	0.077	R-19	0.043
		R-20	0.041

(a) Insulation R-values represent the sum of exterior and/or interior insulation. Basement walls must be insulated from the top of the basement wall to 10 ft below ground level or to the floor of the basement, whichever is less.

Table 7. Slab F-Values

Perimeter Insulation R-Value	Slab F-Value	
	24-in. Insulation Depth	48-in. Insulation Depth
R-0	1.04	1.04
R-1	0.91	0.89
R-2	0.86	0.83
R-3	0.83	0.79
R-4	0.82	0.76
R-5	0.80	0.74
R-6	0.79	0.73
R-7	0.79	0.71
R-8	0.78	0.70
R-9	0.77	0.69
R-10	0.77	0.68
R-11		0.68
R-12		0.67
R-13		0.66
R-14		0.66
R-15		0.65
R-16		0.65
R-17		0.65
R-18		0.64
R-19		0.64
R-20		0.64

Table 8. Crawl Space Wall U-Values

Insulation R-Value	Crawl Space Wall U-Value
R-0	0.477
R-1	0.313
R-2	0.235
R-3	0.189
R-4	0.158
R-5	0.136
R-6	0.120
R-7	0.107
R-8	0.096
R-9	0.088
R-10	0.081
R-11	0.075
R-12	0.069
R-13	0.065
R-14	0.061
R-15	0.057
R-16	0.054
R-17	0.051
R-18	0.049
R-19	0.047
R-20	0.045

Table 9. U-Values for Windows, Glazed Doors, and Skylights^(a)

Frame/Glazing Features	Single Pane	Double Pane
Metal Without Thermal Break		
Operable	1.27	0.87
Fixed	1.13	0.69
Garden Window	2.60	1.81
Curtain Wall	1.22	0.79
Door	1.26	0.80
Skylight	1.98	1.31
Site-Assembled Skylight	1.36	0.82
Metal With Thermal Break		
Operable	1.08	0.65
Fixed	1.07	0.63
Curtain Wall	1.11	0.68
Door	1.10	0.66
Skylight	1.89	1.11
Site-Assembled Skylight	1.25	0.70
Reinforced Vinyl or Metal-Clad Wood		
Operable	0.90	0.57
Fixed	0.98	0.56
Door	0.99	0.57
Skylight	1.75	1.05
Wood/Vinyl/Fiberglass		
Operable	0.89	0.55
Fixed	0.98	0.56
Garden Window	2.31	1.61
Door	0.98	0.56
Skylight	1.47	0.84
Glass Block Assemblies	0.60	

(a) The U-values in these tables can be used in the absence of test U-values. The product cannot receive credit for a feature that cannot be clearly detected. Where a composite of materials from two different product types is used, the product must be assigned the higher U-value.

Table 10. U-Value Table for Non-Glazed Doors^(a)

Steel Doors		
Without Foam Core	0.60	
With Foam Core	0.35	
Wood Doors	Without Storm	With Storm
Panel With 7/16-in. Panels	0.54	0.36
Hollow Core Flush	0.46	0.32
Panel With 1-1/8-in. Panels	0.39	0.28
Solid Core Flush	0.40	0.26

(a) The U-values in these tables can be used in the absence of test U-values. The product cannot receive credit for a feature that cannot be clearly detected. Where a composite of materials from two different product types is used, the product must be assigned the higher U-value.

Typical Thermal Properties of Building Materials--Design Values^a

Description	Density, lb/ft ³	Resistance (R)	
		Per Inch Thickness °F . ft ² . h	For Thickness Listed
SHEATHING			
Gypsum or plaster board 1/2"	50	—	0.45
Gypsum or plaster board 5/8"	50	—	0.56
Plywood (Douglas Fir) 1/2"	34	—	0.62
Plywood (Douglas Fir) 5/8"	34	—	0.77
Plywood or wood panels 3/4"	34	—	0.93
Vegetable fiber board			
Sheathing, regular density 1/2"	18	—	1.32
Hardboard			
Medium density	50	1.37	—
Particleboard			
Medium density	50	1.06	—
FINISH FLOORING MATERIALS			
Carpet and rubber pad	—	—	1.23
INSULATING MATERIALS			
<i>Blanket and Batt</i>			
Mineral fiber, fibrous form processed from rock, slag, or glass			
approx. 3-4 in.	0.4-2.0	—	11
approx. 3.5 in.	0.4-2.0	—	13
approx. 3.5 in.	1.2-1.6	—	15
approx. 5.5-6.5 in.	0.4-2.0	—	19
approx. 5.5 in.	0.6-1.0	—	21
approx. 6-7.5 in.	0.4-2.0	—	22
approx. 8.25-10 in.	0.4-2.0	—	30
approx. 10-13 in.	0.4-2.0	—	38
<i>Board and Slabs</i>			
Glass fiber, organic bonded	4.0-9.0	4.00	—
Expanded polystyrene, extruded (smooth skin surface)	1.8-3.5	5.00	—
Expanded polystyrene, molded beads	1.0	3.85	—
	1.25	4.00	—
	1.5	4.17	—
	1.75	4.17	—
	2.0	4.35	—
Cellular polyurethane/polyisocyanurate	1.5	6.25-5.56	—
Cellular polyisocyanurate (CFC-11 exp.) (gas-impermeable facers)	2.0	7.04	—
Mineral fiberboard, wet felted			
Acoustical tile	18.0	2.86	—
<i>Loose Fill</i>			
Cellulosic insulation (milled paper or wood pulp)	2.3-3.2	3.70-3.13	—
Perlite, expanded	2.0-4.1	3.7-3.3	—
	4.1-7.4	3.3-2.8	—
	7.4-11.0	2.8-2.4	—
Mineral fiber (rock, slag, or glass)			
approx. 3.75-5 in.	0.6-2.0	—	11.0
approx. 6.5-8.75 in.	0.6-2.0	—	19.0
approx. 7.5-10 in.	0.6-2.0	—	22.0
approx. 10.25-13.75 in.	0.6-2.0	—	30.0
Mineral fiber (rock, slag, or glass)			
approx. 3.5 in. (closed sidewall application)	2.0-3.5	—	12.0-14.0
Vermiculite, exfoliated	7.0-8.2	2.13	—
	4.0-6.0	2.27	—
<i>Spray Applied</i>			
Polyurethane foam	1.5-2.5	6.25-5.56	—
Ureaformaldehyde foam	0.7-1.6	4.55-3.57	—
Cellulosic fiber	3.5-6.0	3.45-2.94	—
Glass fiber	3.5-4.5	3.85-3.70	—

Comm 20-25 APPENDIX

WISCONSIN ADMINISTRATIVE CODE

ROOFING

Asphalt shingles	70	—	0.44
------------------	----	---	------

PLASTERING MATERIALS

Cement plaster, sand aggregate	116	0.20	—
0.75 in.	—	—	0.15

MASONRY MATERIALS

Masonry Units

Brick, fired clay	150	0.12–0.10	—
Concrete blocks			
Normal weight aggregate (sand and gravel)			
8 in., 33–36 lb, 126–136 lb/ft ³ concrete, 2 or 3 cores	—	—	1.11–0.97
Same with perlite filled cores	—	—	2.0
Same with vermiculite filled cores	—	—	1.92–1.37
12 in., 50 lb, 125 lb/ft ³ concrete, 2 cores	—	—	1.23

Concretes

Sand and gravel or stone aggregate concretes	150	0.10	—
--	-----	------	---

SIDING MATERIALS (on flat surface)

Siding

Asphalt roll siding	—	—	0.15
Hardboard siding, 7/16"	—	—	0.67
Wood, drop, 1 by 8 in.	—	—	0.79
Aluminum, steel, or vinyl, over sheathing			
Hollow-backed	—	—	0.61
Insulating-board backed nominal 3/8"	—	—	1.82
Insulating-board backed nominal 3/8", foil backed	—	—	2.96

WOOD

Maples, oak and similar materials	45	0.91	
Fir, pine and similar materials	32	1.25	
3/4"	32	0.94	
1–1/2"	32	1.9	
3–1/2"	32	4.4	
5–1/2"	32	6.9	
7–1/4"	32	9.1	
9–1/4"	32	11.6	
11–1/4"	32	14.1	

^aValues are for a mean temperature of 75°F. Representative values for dry materials are intended as design (not specification) values for materials in normal use. Thermal values of insulating materials may differ from design values depending on their in-situ properties (e.g., density and moisture content, orientation, etc.) and variability experienced during manufacture. For properties of a particular product, use the value supplied by the manufacturer or by unbiased tests in accordance with s. Comm 22.31.

s. Comm 22.26
Slab-On-Grade Insulation Details

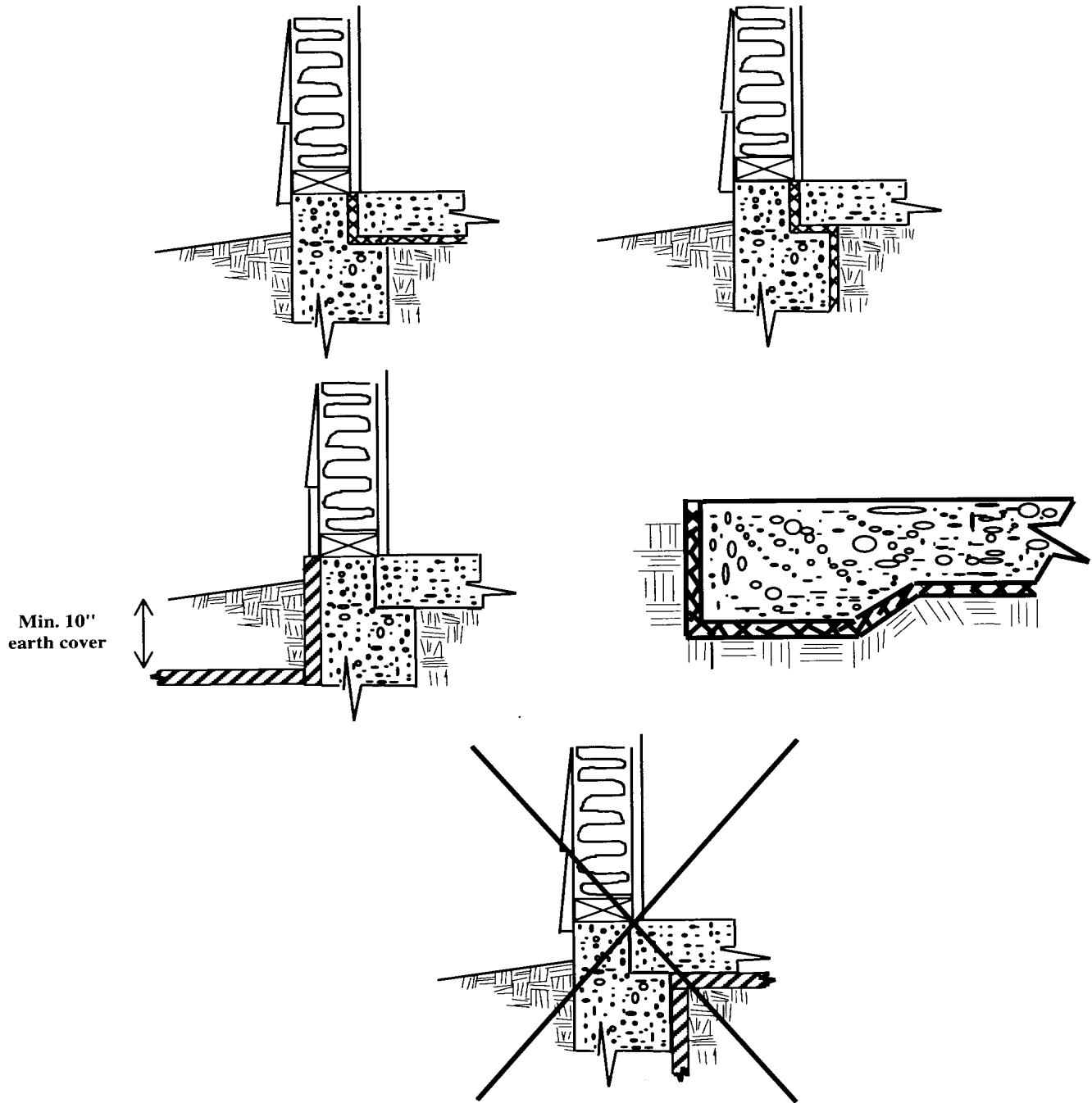

Insulation shall extend vertically and horizontally for a total of 48". In all cases the insulation shall insulate to the top edge of the floor perimeter. The last diagram is not an acceptable method.

Submit to non-enforcing municipalities for new 1- and 2- family dwellings

WISCONSIN ADMINISTRATIVE BUILDING PERMIT APPLICATION
(Wis. Stats. 101.63 (7) & 101.65 (3))
EE INSTRUCTIONS ON BACK OF YELLOW COPY.

State of Wisconsin
Safety and Buildings Division

Personal information you provide may be used for secondary purposes. [Privacy Law 15.04(1)(m)]

PERMIT APPLICANT					
Last Name		First Name		Middle Initial	
Street Address					
City		State	Zip Code	Telephone No. (Include area code)	
PROJECT LOCATION					
Building Address			Subdivision Name		Lot #
Legal Description					Parcel No.
1/4, 1/4, Section T N, R E or W					
1. PROJECT TYPE		2. HVAC EQUIPMENT			
<input type="checkbox"/> 1 Family	<input type="checkbox"/> Forced Air Furnace	<input type="checkbox"/> Radiant Baseboard or Panel		<input type="checkbox"/> Heat Pump	
<input type="checkbox"/> 2 Family	<input type="checkbox"/> Boiler	<input type="checkbox"/> Central AC		<input type="checkbox"/> Other:	
3. ENERGY SOURCE					
Space Heating		Nat Gas	L.P.	Oil	Elect.
Water Heating		<input type="checkbox"/>	<input type="checkbox"/>	<input type="checkbox"/>	<input type="checkbox"/>
		<input type="checkbox"/>	<input type="checkbox"/>	<input type="checkbox"/>	<input type="checkbox"/>
		<input type="checkbox"/>	<input type="checkbox"/>	<input type="checkbox"/>	<input type="checkbox"/>
4. CONSTRUCTION TYPE			5. FOUNDATION		
<input type="checkbox"/> Site Constructed			<input type="checkbox"/> Concrete		
<input type="checkbox"/> Manufactured			<input type="checkbox"/> Masonry		
			<input type="checkbox"/> Treated Wood		
			<input type="checkbox"/> Other (specify):		
6. AREA			7. ESTIMATED BUILDING COST		
Living area =		Square Feet	\$		
<p>I vouch that all the above information is correct, and understand that the issuance of this permit is for administrative purposes only. I understand that onsite construction inspections will not be performed by the municipality, but that the Uniform Dwelling Code, Chapters Comm/ILHR 20-25, still applies to all new 1- and 2-family dwellings and must be complied with. I understand that the issuance of this permit does not relieve me of compliance with other applicable codes and ordinances.</p>					
Applicant's Signature				Date Signed	
MUST BE COMPLETED BY THE MUNICIPALITY BEFORE FORWARDING PINK PLY TO THE STATE DIVISION OF SAFETY AND BUILDINGS					
ISSUING JURISDICTION:		<input type="checkbox"/> Town <input type="checkbox"/> Village <input type="checkbox"/> City <input type="checkbox"/> County of:			
MUNICIPALITY NUMBER: <small>of Dwelling Location</small>		# _____ - _____		FEES:	
PERMIT ISSUED BY:				DATE ISSUED:	

SBD-8254 (R 01/98)

White - Issuing Jurisdiction

Pink - State Within 30 Days

Yellow - Applicant

INSTRUCTIONS

The owner, builder or agent shall complete and provide all required information on the application form down through the Signature of Applicant block. This data is used for statewide statistical gathering on new one- and two-family dwellings, as well as for local administration. When completed, submit to local municipality having jurisdiction. Plan review or building inspections will not be performed by the municipality.

PERMIT REQUESTED:

- Fill in building address.
- Fill in legal description of lot, subdivision name, lot number and block number.

PROJECT DATA:

- Fill in **all numbered** project data blocks (1-7) with the required information. All data blocks must be filled in, including the following:
 1. **Type** – Check only “1-Family” or “2-Family” if that is what is being built. In other words, do NOT use this form if only a new detached garage is being built, even if it serves a one or two family dwelling.
 2. **HVAC Equipment** – Check only the major source of heat, not any supplemental sources. Mark central air conditioning if present. Only check “Radiant Baseboard or Panel” if there is no central source of heat.
 6. **Living Area** – Include any finished area including finished areas in basements. For two-family dwellings, include total combined areas.
 7. **Estimated Cost** – Include the total cost of construction, but not cost of land or landscaping.

SIGNATURE:

- Sign and date application form.

ISSUING JURISDICTION – This must be completed by the AUTHORITY HAVING JURISDICTION.

Check off MUNICIPALITY STATUS of issuing jurisdiction, such as town, village, city or county.

Fill in MUNICIPALITY NUMBER OF DWELLING LOCATION. If issued by a county, indicate the specific municipality number where the dwelling will be built.

Fill in name of person issuing permit and date building permit issued.

PLEASE RETURN PINK COPY WITHIN 30 DAYS AFTER ISSUANCE TO (You may fold along the dashed lines and insert this form into a window envelope.):

**Safety & Buildings Division
P O Box 2509
Madison, WI 53701-2509**

**INSPECTION REPORT AND
NOTICE OF NONCOMPLIANCE**

Report Date:	Inspection Date	Permit No.:	Parcel No:		
Project Address		Subdivision	Lot No.:	Block No.:	
Inspection Type(s)	<input type="checkbox"/> Footing <input type="checkbox"/> Heat/Vent/AC	<input type="checkbox"/> Erosion Control <input type="checkbox"/> Plumbing	<input type="checkbox"/> Foundation <input type="checkbox"/> Electrical	<input type="checkbox"/> Bsmt Drain Tile <input type="checkbox"/> Insulation/Energy	<input type="checkbox"/> Construction <input type="checkbox"/> Occupancy
Owner:		Contractor:			

AN INSPECTION OF THE ABOVE PREMISES HAS DISCLOSED THE FOLLOWING NONCOMPLIANCES:

ORDER NO.	CODE SECTION	FINDINGS AND REQUIREMENTS
Sample		

IMPORTANT: Please report when violation are corrected. AVOID DELAY

NOTICE OF NONCOMPLIANCE

All cited violations shall be corrected within 30 days after written notification unless an extension of time is granted. Each day that the violation continues after notice shall constitute a separate offense and is subject to remedies and penalties by the authority having jurisdiction.

Enforcement Jurisdiction:	<input type="checkbox"/> Town	<input type="checkbox"/> County	<input type="checkbox"/> City	Authority By Municipal Ordinance Section::
	<input type="checkbox"/> Village	<input type="checkbox"/> State	OF	

Inspector's Name:	Violations Explained To:	Compliance Date:
-------------------	--------------------------	------------------

Inspector's Address:	Office Hours:	Telephone No:
----------------------	---------------	---------------