

5/10  
Filed Sept 7 - 1956

11:05 am

IND 41.0142.04

STATE OF WISCONSIN )  
DEPT. OF INDUSTRIAL COMMISSION ) SS.

TO ALL TO WHOM THESE PRESENTS SHALL COME, GREETINGS:

I, Helen E. Gill, Secretary of the Industrial Commission of Wisconsin, and custodian of the official records of said commission, do hereby certify that pursuant to Sec. 101.01-101.29 inclusive, Wisconsin Statutes, the Industrial Commission on September 4, 1956 voted to repeal old orders:

4101, 4111, 4216, 4267, 4268, 4300, 4301, 4302, 4304, 4305, 4306, 4307, 4308, 4309, 4310, 4311, 4312, 4313, 4314, 4315, 4316, 4317, 4318, 4319, 4320, 4321, 4322, 4323, 4324, 4325, 4326, 4327, 4328, 4329, 4330, 4331, 4332, 4333, 4334, 4335, 4336, 4337, 4338, 4339, 4340, 4341, 4342, 4343, 4344, 4345, 4346, 4347, 4348, 4349, 4350, 4351, 4352, 4353, 4354, 4355, 4356, 4357, 4358, 4359, 4360, 4361, 4362, 4363, 4364, 4365, 4366, 4367, 4368, 4369, 4370, 4371, 4372, 4373, 4374, 4375, 4376, 4377, 4378, 4379, 4380, 4381, 4382, 4383, 4384, 4385, 4386, 4387, 4388, 4389, 4390, 4391, 4392, 4393, 4394, 4395, 4397, 4398, 4399, 4400, 4402, 4403, 4404, 4405, 4406, 4408, 4409, 4410, 4411, 4412, 4413, 4415, 4416, 4417, 4418, 4419, 4421, 4422, 4423, 4425, 4426, 4427, 4431, 4432, 4433, 4434, 4435, 4436, 4439, 4440, 4441, 4442, 4443, 4444, 4445, 4446, 4447, 4448, 4449, 4450, 4451, 4452, 4453, 4454, 4455, 4470, 4475, 4476, 4477, 4478, 4479, 4480, 4481, 4482, 4483, 4484, 4485, 4486, 4487, 4488, 4489, 4490, 4491,

and to revise old orders as follows:

<u>Old Orders</u>	<u>New Orders</u>
4100	Ind 41.01
4102	Ind 41.02
4103	Ind 41.03
4104	Ind 41.04
4105	Ind 41.05
4106	Ind 41.06
4107	Ind 41.07
4108	Ind 41.08
4109	Ind 41.09
4110	Ind 41.10
4150	Ind 41.50
4151	Ind 41.51
4200	Ind 42.00
4201	Ind 42.01
4203	Ind 42.03
4204	Ind 42.04

and adopt new order Ind 41.001 of the Wisconsin Boiler Code; I further certify that repeal of the old orders and the adoption of the new order and revised orders be effective January 1, 1957.

I further certify that said copy has been compared by me with the original on file in this commission, and that the same is a true copy thereof, and of the whole of such original.

IN TESTIMONY WHEREOF, I have hereunto set my hand and affixed the official seal of the department at the Capitol in the City of Madison, this 5th day of September, A. D., 1956. 13-16

  
Secretary

*Filed Dec. 3-1952*

# **Wisconsin Administrative Code**

**Rules of**

## **INDUSTRIAL COMMISSION**

### **BOILER AND UNFIRED PRESSURE VESSEL CODE**

**Cite the rules in this Code as**

**(for example)**

**Wis. Adm. Code section Ind 41.001**

**INDUSTRIAL COMMISSION**

**State Office Building, Madison 2, Wisconsin**

STATE OF WISCONSIN )  
 ) SS.  
DEPT. OF INDUSTRIAL COMMISSION )

TO ALL TO WHOM THESE PRESENTS SHALL COME, GREETINGS:

I, Helen E. Gill, Secretary of the Industrial Commission of Wisconsin, and custodian of the official records of said commission, do hereby certify that pursuant to Sec. 101.01-101.29 inclusive, Wisconsin Statutes, the Industrial Commission on September 4, 1956 voted to repeal old orders:

4101, 4111, 4216, 4267, 4268, 4300, 4301, 4302, 4304, 4305, 4306, 4307,  
4308, 4309, 4310, 4311, 4312, 4313, 4314, 4315, 4316, 4317, 4318, 4319,  
4320, 4321, 4322, 4323, 4324, 4325, 4326, 4327, 4328, 4329, 4330, 4331,  
4332, 4333, 4334, 4335, 4336, 4337, 4338, 4339, 4340, 4341, 4342, 4343,  
4344, 4345, 4346, 4347, 4348, 4349, 4350, 4351, 4352, 4353, 4354, 4355,  
4356, 4357, 4358, 4359, 4360, 4361, 4362, 4363, 4364, 4365, 4366, 4367,  
4368, 4369, 4370, 4371, 4372, 4373, 4374, 4375, 4376, 4377, 4378, 4379,  
4380, 4381, 4382, 4383, 4384, 4385, 4386, 4387, 4388, 4389, 4390, 4391,  
4392, 4393, 4394, 4395, 4397, 4398, 4399, 4400, 4402, 4403, 4404, 4405,  
4406, 4408, 4409, 4410, 4411, 4412, 4413, 4415, 4416, 4417, 4418, 4419,  
4421, 4422, 4423, 4425, 4426, 4427, 4431, 4432, 4433, 4434, 4435, 4436,  
4439, 4440, 4441, 4442, 4443, 4444, 4445, 4446, 4447, 4448, 4449, 4450,  
4451, 4452, 4453, 4454, 4455, 4470, 4475, 4476, 4477, 4478, 4479, 4480,  
4481, 4482, 4483, 4484, 4485, 4486, 4487, 4488, 4489, 4490, 4491,

INDUSTRIAL COMMISSION  
OF  
WISCONSIN

R. G. Knutson  
*Chairman*

A. W. Enright  
*Commissioner*

John H. Rouse  
*Commissioner*

Helen E. Gill, *Secretary*

Roger Ostrem  
*Director, Division of  
Industrial Safety and Buildings*

Frank J. Bishop  
*Supervisor  
Boiler Inspection*

**BOILER AND UNFIRED PRESSURE VESSEL CODE**

Revised 1956

Issued by  
**INDUSTRIAL COMMISSION OF WISCONSIN**

Madison, Wisconsin

1957

# BOILER AND UNFIRED PRESSURE VESSEL CODE

## INTRODUCTION

The frequency of boiler explosions, with the resulting loss of life and damage to property, compelled the Industrial Commission almost immediately after it was organized to attempt the formulation of a code of boiler rules. The first code was adopted by the Industrial Commission on December 14, 1914 and became effective January 18, 1915. This code was amended in many material respects on November 29, 1915 to correspond more closely with the standard code of boiler rules recommended by the American Society of Mechanical Engineers. Further amendments to this code were adopted on October 20, 1919. On October 5, 1927 the Industrial Commission adopted a resolution which repealed all the boiler orders contained in the code of "Boiler Rules" of 1920. The same resolution provided for the adoption of the orders contained in the revised "Boiler Code of January 1928." On March 1, 1944 the "Boiler Code of 1928" was revised and adopted by the Industrial Commission on March 4, 1944.

In November 1952 the Industrial Commission appointed an advisory committee to revise the boiler code of 1944 and to formulate a code which would cover both boilers and unfired pressure vessels, with the provision that the effect of boilers and unfired pressure vessel orders in force from July 1, 1916 to December 31, 1956, inclusive, shall not be impaired as to any boiler or unfired pressure vessel installed between these dates.

There have been important changes in the field of boiler and unfired pressure vessel design and fabrication since the adoption of the 1944 boiler code. The demand for greater economy of operation has resulted in higher steam pressures and in higher temperatures. To maintain the required standards for reasonable safety under these changed operating conditions, it has been necessary to introduce alloy steels in the design of high pressure boilers and unfired pressure vessels and it was necessary to resort to fusion welding of joints in order to secure the desired strength and tightness.

With a full knowledge of these changed conditions the Industrial Commission is confident that this newly revised code as of January 1, 1957 will adequately meet all minimum requirements for reasonable safety.

On September 4, 1956 the Industrial Commission voted to repeal old orders: 4101, 4111, 4216, 4267, 4268, 4300, 4301, 4302, 4304, 4305, 4306, 4307, 4308, 4309, 4310, 4311, 4312, 4313, 4314, 4315, 4316, 4317, 4318, 4319, 4320, 4321, 4322, 4323, 4324, 4325, 4326, 4327, 4328, 4329, 4330, 4331, 4332, 4333, 4334, 4335, 4336, 4337, 4338, 4339, 4340, 4341, 4342, 4343, 4344, 4345, 4346, 4347, 4348, 4349, 4350, 4351, 4352, 4353, 4354, 4355, 4356, 4357, 4358, 4359, 4360, 4361, 4362, 4363, 4364, 4365, 4366, 4367, 4368, 4369, 4370, 4371, 4372, 4373, 4374, 4375, 4376, 4377,

4378, 4379, 4380, 4381, 4382, 4383, 4384, 4385, 4386, 4387, 4388, 4389,  
 4390, 4391, 4392, 4393, 4394, 4395, 4397, 4398, 4399, 4400, 4402, 4403,  
 4404, 4405, 4406, 4408, 4409, 4410, 4411, 4412, 4413, 4415, 4416, 4417,  
 4418, 4419, 4421, 4422, 4423, 4425, 4426, 4427, 4431, 4432, 4433, 4434,  
 4435, 4436, 4439, 4440, 4441, 4442, 4443, 4444, 4445, 4446, 4447, 4448,  
 4449, 4450, 4451, 4452, 4453, 4454, 4455, 4470, 4475, 4476, 4477, 4478,  
 4479, 4480, 4481, 4482, 4483, 4484, 4485, 4486, 4487, 4488, 4489, 4490,  
 4491,

and to revise old orders as follows:

<i>Old Orders</i>	<i>New Orders</i>	<i>Old Orders</i>	<i>New Orders</i>	<i>Old Orders</i>	<i>New Orders</i>	<i>Old Orders</i>	<i>New Orders</i>
4100	Ind 41.01	4204	Ind 42.04	4223	Ind 42.23	4259	Ind 42.59
4102	" 41.02	4205	" 42.05	4224	" 42.24	4260	" 42.60
4103	" 41.03	4206	" 42.06	4225	" 42.25	4261	" 42.61
4104	" 41.04	4207	" 42.07	4226	" 42.26	4262	" 42.62
4105	" 41.05	4208	" 42.08	4227	" 42.27	4263	" 42.63
4106	" 41.06	4213	" 42.13	4231	" 42.31	4264	" 42.64
4107	" 41.07	4214	" 42.14	4232	" 42.32	4265	" 42.65
4108	" 41.08	4215	" 42.15	4233	" 42.33	4266	" 42.66
4109	" 41.09	4216	" 42.16	4250	" 42.50	4269	" 42.69
4110	" 41.10	4217	" 42.17	4251	" 42.51	4274	" 42.74
4150	" 41.50	4218	" 42.18	4252	" 42.52	4275	" 42.75
4151	" 41.51	4219	" 42.19	4253	" 42.53	4428	" 44.28
4200	" 42.00	4220	" 42.20	4254	" 42.54	4429	" 44.29
4201	" 42.01	4221	" 42.21	4255	" 42.55	4430	" 44.30
4203	" 42.03	4222	" 42.22	4256	" 42.56		

and adopted new order Ind 41.001.

The old orders will be repealed and the new and revised orders will become effective on January 1, 1957.

## ADVISORY COMMITTEE

An advisory committee of boiler and unfired pressure rules appointed by the Industrial Commission without compensation, may hold hearings and gather such information as will assist in the formation of recommendations to the commission that will insure safety in the construction, installation and operation of steam boilers and unfired pressure vessels.

In the preparation of boiler and unfired pressure vessel rules, the Industrial Commission has had the assistance of the following members of the advisory committee:

- C. W. Wheatley, Milwaukee, Wisconsin (Chairman.) Representing the Wisconsin Manufacturers' Association.
- Frank R. Boicourt, Milwaukee, Wisconsin (Vice Chairman.) Representing the Boiler and Pressure Vessel Insurance Companies.
- G. J. Enright, Milwaukee, Wisconsin. Representing the Wisconsin State Federation of Labor.
- George M. Kuetemeyer, Milwaukee, Wisconsin. Representing the City of Milwaukee.
- R. H. Winters, Green Bay, Wisconsin. Representing the Wisconsin Cannery Association.
- L. G. Pfeiffer, Milwaukee, Wisconsin. Representing the Pressure Vessels Manufacturers.
- Edward J. Berry, Milwaukee, Wisconsin. Representing the Boiler Manufacturers.
- R. E. Cannard, Manitowoc, Wisconsin. Representing the Wisconsin Utilities.
- Gordon Mortensen, Neenah, Wisconsin. Representing the Paper Manufacturers.
- Charles E. Miller, Milwaukee, Wisconsin. Representing the Wisconsin Petroleum Industries.
- Thomas H. Quail, Milwaukee, Wisconsin. Representing the Wisconsin Liquefied Petroleum Gas Association.
- Roland G. Strid, Green Bay, Wisconsin. Representing the Agricultural Ammonia Institute.
- Frank J. Bishop, Madison, Wisconsin (Secretary.) Representing the Industrial Commission of Wisconsin.

## Jurisdiction of Industrial Commission

Boilers and unfired pressure vessels must comply with the laws of the state enacted for the safety of employees and frequenters in places of employment and public buildings and with orders of the industrial commission, adopted and published in conformity with sections 101.01 to 101.28, inclusive, of the statutes.

## Penalty for Violation of Orders

**Section 101.28 Penalty for violations.** If any employer, employe, owner, or other person shall violate any provisions of sections 101.01 to 101.13, inclusive, of the statutes, or shall do any act prohibited in sections 101.01 to 101.29, inclusive, or shall fail or refuse to perform any duty lawfully enjoined, within the time prescribed by the commission, for which no penalty has been specifically provided, or shall fail, neglect or refuse to obey any lawful order given or made by the commission, or any judgment or decree made by any court in connection with the provisions of sections 101.01 to 101.29, inclusive, for each such violation, failure or refusal, such employer, employe, owner or other person shall forfeit and pay into the state treasury a sum not less than ten dollars nor more than one hundred dollars for each such offense. It shall be the duty of all officers of the state, the counties and municipalities, upon request of the industrial commission, to enforce in their respective departments, all lawful orders of the industrial commission, insofar as the same may be applicable and consistent with the general duties of such officers.

## Appeal

**Section 101.13 Orders of commission declared lawful.** All orders of the industrial commission in conformity with law shall be in force, and shall be prima facie lawful; and all such orders shall be valid and in force, and prima facie reasonable and lawful until they are found otherwise upon judicial review thereof pursuant to chapter 227 or until altered or revoked by the commission.

## Administration

The boiler and unfired pressure vessel code is enforced by the industrial commission, in cooperation with municipal and other local officials who are required by law to enforce all orders of the commission which are germane to their respective duties (Wisconsin Statutes Section 101.28) and in cooperation with inspectors and insurance companies. This boiler and unfired pressure vessel code contains minimum standards and requirements which apply to places of employment and public buildings in cities and the state generally, and no local ordinance or code may be less stringent.

## Chapter Ind 41

### BOILER AND UNFIRED PRESSURE VESSEL CODE

Ind 41.001	Definitions as used in chapters Ind 41 and 42	Ind 41.08	Certificate of competency for inspectors
Ind 41.01	Safety regulations	Ind 41.09	Stamps and numbers on boilers and unfired pressure vessels
Ind 41.02	Inspection	Ind 41.10	Special type of boilers or unfired pressure vessels
Ind 41.03	Non-periodic inspections	Ind 41.11	Boiler blow-down equipment
Ind 41.04	Insurance inspections	Ind 41.50	New construction
Ind 41.05	Inspection by certain cities	Ind 41.51	Exceptions to Ind 41.50
Ind 41.06	Exemptions		
Ind 41.07	Inspection certificates		

**Ind 41.001 Definitions as used in chapters Ind 41 and 42.** (1) The term ADVISORY BOARD shall mean a group of persons appointed to advise the Industrial Commission of Wisconsin which is designated by law to administer the regulations.

(2) The term A.S.M.E. BOILER AND UNFIRED PRESSURE VESSEL CODES shall mean the Boiler and Unfired pressure Vessel Codes of the American Society of Mechanical Engineers.

(3) The terms AUTHORIZED INSPECTOR or QUALIFIED INSPECTOR shall mean:

(a) *For shop inspectors.* Any individual who has been commissioned by the National Board of Boiler and Pressure Vessel Inspectors and holds a certificate of competency issued by the Wisconsin Industrial Commission.

(b) *For field inspectors.* Any individual who holds a certificate of competency issued by the Wisconsin Industrial Commission.

(4) The term BOILER AND UNFIRED PRESSURE VESSEL CODE is used to designate the accepted reference for construction, installation, operation, and inspection of boilers and unfired pressure vessels.

(5) The term CERTIFICATE OF COMPETENCY shall mean a certificate issued to a person who has passed an examination prescribed by the industrial commission.

(6) The term EXISTING INSTALLATIONS insofar as the application of these rules and regulations are concerned, shall mean and include all boilers and unfired pressure vessels constructed, installed, placed in operation or "Contracted for" before January 1, 1957.

(7) The term EXTERNAL INSPECTION shall mean an inspection made when a boiler or unfired pressure vessel is in operation.

(8) The term FUSION WELDING shall mean a process of welding metals in a molten, or molten and vaporous state, without the application of mechanical pressure or blows. Such welding may be accomplished by gas flame or by the electric arc.

(9) The term HOT WATER HEATING AND HOT WATER SUPPLY BOILER shall mean a boiler completely filled with water which furnishes hot water to be used externally to itself, at pressures not exceeding 160 pounds per square inch gage and at temperatures not exceeding 250°



Fahrenheit. If the boiler exceeds these limits, it shall be considered a Power Boiler.

(10) The term INTERNAL INSPECTION shall mean an inspection made when a boiler or unfired pressure vessel is shut down and handholes and manholes, or other inspection openings are opened or removed for inspection of the interior.

(11) The term LOW PRESSURE STEAM BOILER shall mean a boiler on which the safety valves are set at pressures not exceeding 15 pounds per square inch gage.

(12) The term MAJOR REPAIR used herein shall be considered as one upon which the strength of a boiler or unfired pressure vessel would depend.

(13) The term MINIATURE BOILER as used herein shall mean any boiler which generates steam or other vapor on which the safety valve is set at over 15 psi pressure, which does not exceed any of the following limits: 16 inches inside diameter of the shell, 42 inches over-all length of outside to outside of heads at center, 20 square feet of water heating surface, 100 pounds per square inch maximum allowable working pressure.

(14) The term NEW BOILER OR UNFIRED PRESSURE VESSEL INSTALLATIONS insofar as the application of these rules and regulations are concerned, shall mean and include all boilers and unfired pressure vessels constructed, installed, placed in operation or "Contracted for" after January 1, 1957.

(15) The term NON-STANDARD BOILER OR UNFIRED PRESSURE VESSEL shall mean a boiler or unfired pressure vessel that does not bear the Wisconsin state stamp, the A.S.M.E. stamp, the National Board stamp, the A.P.I.-A.S.M.E. stamp, the Interstate Commerce Commission stamp as accepted in section Ind 41.51 (3), or the stamp authorized by other recognized codes.

(16) The term OWNER OR USER as used herein shall mean any person, firm or corporation owning or operating any boiler or unfired pressure vessel within this state.

(17) The term PORTABLE BOILER shall mean an internally fired boiler which is primarily intended for temporary location and the construction and usage is obviously portable.

(18) The term POWER BOILER shall mean a closed vessel in which steam or other vapor (to be used externally to itself) is generated by the direct application of heat and has a safety valve set at a pressure of more than 15 pounds per square inch gage and which exceeds the dimensions for miniature boilers.

(19) The term PRESSURE VESSEL when used collectively shall include power boilers, low pressure heating boilers, high pressure steam boilers, miniature boilers, hot water heating and supply boilers, and unfired pressure vessels.

(20) The term SECOND HAND BOILERS OR UNFIRED PRESSURE VESSELS shall mean a boiler or unfired pressure vessel of which both the location and ownership have been changed after primary use.

(21) The term UNFIRED PRESSURE VESSEL shall mean a vessel in which pressure is obtained from an external source, or from an indirect application of heat. Vessels used for the storage and transport-

tation of liquid petroleum\* gases or anhydrous ammonia\* and all the refrigerant\* containing vessels are also defined as unfired pressure vessels but shall not be covered by sections Ind 41.01 to 41.09 and sections Ind 41.001 to 42.40 of this code since they are covered by other state codes. The term UNFIRED PRESSURE VESSEL shall not include such vessels as air eliminators, scraper traps, and similar devices on the pumping and dispensing equipment or systems used in the transportation, storage or distribution of flammable liquids.

\*Note: For the installation, operation, and field inspection of vessels used for the storage and transportation of liquid petroleum gas, anhydrous ammonia, and all the refrigerant containing vessels, see the state code which governs. The construction, shop inspection, and repair of these vessels shall be governed by sections Ind 41.50 and Ind 41.51 and sections Ind 42.50 to Ind 42.80 of this code.

(22) The term WISCONSIN SPECIAL BOILER AND UNFIRED PRESSURE VESSEL shall mean a boiler or unfired pressure vessel which bears the stamp "Wisconsin Special or Wisconsin Standard."

History: Cr. Register, December, 1956, No. 12, eff. 1-1-57.

#### GENERAL REQUIREMENTS FOR THE INSTALLATION, OPERATION AND FIELD INSPECTION OF BOILERS AND UNFIRED PRESSURE VESSELS

Ind 41.01 Safety regulations. (1) No boiler or unfired pressure vessel shall be operated at a pressure in excess of the maximum allowable working pressure allowed by the inspection certificate (see section Ind 41.07) which pressure is to be ascertained by means of these orders.

(2) Boilers and unfired pressure vessels shall be equipped with such appliances as to insure safety of operation as hereinafter ordered.

(3) No unauthorized person shall remove or tamper with any safety appliances prescribed by the hereinafter orders, and no unauthorized person shall in any manner load the safety valve to a greater pressure than that allowed by the certificate of inspection.

(4) In all cases, boilers and unfired pressure vessels shall be so placed as to give ample room between any ceiling, wall or partition to connect and operate any valves or pipes or other fittings or connections used in any such boilers and unfired pressure vessels.

(5) Whoever owns, uses, or causes to be used a boiler or unfired pressure vessel, except those covered in section Ind 41.03, unless the same is under the periodically guaranteed inspection of cities or insurance companies allowed by the industrial commission to conduct their own inspections, shall report to the industrial commission on January 1 of each year the location of such boilers and on January 1 of each even numbered year the location of such unfired pressure vessels.

(6) The owner or user of any boiler or any unfired pressure vessel shall immediately notify the industrial commission in case a defect is discovered affecting the safety of the boiler or the unfired pressure vessel. The owner or user of a boiler or an unfired pressure vessel shall notify the industrial commission when an accident occurs which serves to render a boiler or an unfired pressure vessel inoperative. In case of a serious accident, such as an explosion, notice shall be given immediately to the industrial commission and neither the boiler

Boiler and Unfired Pressure Vessel Code Register, December, 1956, No. 12

or the unfired pressure vessel or any of the parts thereof shall be removed or disturbed before an inspection has been made by the industrial commission.

**History:** Cr. Register, December, 1956, No. 12, eff. 1-1-57.

**Ind 41.02 Inspection.** (1) **INSPECTION OF STEAM BOILERS.** All steam boilers operated in the state of Wisconsin, except those included in section Ind 41.03, shall be subject to regular internal and external inspection once each 12 months. Should operating conditions require longer periods than 12 months, an extension of time may be granted on application to the commission.

(2) **INSPECTION OF UNFIRED PRESSURE VESSELS.** All unfired pressure vessels operated in the state of Wisconsin, except those included in section Ind 41.03 shall be subjected to internal or external inspections once each 24 months.

(3) **PREPARATION.** The owner or user of a boiler or an unfired pressure vessel subject to inspection shall prepare the vessel for inspection. To prepare a vessel for an internal inspection, all handhole, manhole plates and washout plugs shall be removed. The shell and heads shall be thoroughly cleaned and exposed when so ordered. Each steam boiler shall be relieved of steam pressure, opened up, thoroughly drained of hot water and the combustion chamber and furnace cleaned out before any internal inspection or repairs are made.

**History:** Cr. Register, December, 1956, No. 12, eff. 1-1-57.

**Ind 41.03 Non-periodic inspections.** The following boilers and unfired pressure vessels will not be subject to periodic inspection, but in individual cases any such vessel will be subject to inspection by order of the commission upon complaint of any person or upon initiative of the commission when there is reasonable cause to suspect that its construction, installation, maintenance or operation is not in keeping with the general purpose and intent of the applicable provisions of this code.

(1) Boilers or unfired pressure vessels which receive regular inspections by United States government inspectors.

(2) Steam boilers or unfired pressure vessels having an internal or external operating pressure not exceeding 15 psi with no limitations to size. Hot water boilers having an internal operating pressure not exceeding 30 psi with no limitations to size.

(3) Boilers of steam fire engines.

(4) Boilers used exclusively for agricultural purposes.

(5) Boilers or water heaters of less than 100 square feet of water heating surface.

(6) Unfired pressure vessels having an inside diameter not exceeding 6 inches with no limitation to pressure.

(7) Unfired pressure vessels having a volume of less than 5 cubic ft. and an operating pressure of less than 250 psi.

(8) Unfired pressure vessels with a volume of less than 1½ cubic ft. with no limit on pressure.

(9) Unfired pressure vessels which are used in accordance with the regulations of the interstate commerce commission.

Boiler and Unfired Pressure Vessel Code Register, December, 1956, No. 12

(10) Air receivers having a volume not to exceed 12 cubic feet and an operating pressure of less than 225 psi.

**History:** Cr. Register, December, 1956, No. 12, eff. 1-1-57.

**Ind 41.04 Insurance inspections.** All boilers and unfired pressure vessels subject to periodic inspections of insurance companies authorized to insure pressure vessels in this state, shall not be subject to regular inspections by the industrial commission on the following conditions:

(1) The insurance companies' regulations shall conform with the applicable orders in this code.

(2) The insurance companies' inspectors who inspect boilers and unfired pressure vessels operated in the state shall hold certificates of competency issued by the industrial commission.

(3) Reports of all inspections shall conform to the requirements of the industrial commission.

(4) A copy of all reports shall be forwarded to this industrial commission within 30 days after the inspection is made.

(5) Insurance companies shall report to the industrial commission the name of the owner or operator, and the location of every boiler and unfired pressure vessel on which insurance has been refused, cancelled or discontinued, giving the reasons thereof.

**History:** Cr. Register, December, 1956, No. 12, eff. 1-1-57.

**Ind 41.05 Inspection by certain cities.** Boilers and unfired pressure vessels within the regular corporate limits of cities of the first, second and third class which are regularly inspected by a qualified inspector of the city will not be subject to regular inspections by the industrial commission, provided such vessels are properly installed, equipped with fittings necessary to safety, and are not operated at pressures in excess of those determined pursuant to this code.

**History:** Cr. Register, December, 1956, No. 12, eff. 1-1-57.

**Ind 41.06 Exemptions.** Boilers and unfired pressure vessels owned or operated by companies or corporations may be exempt from inspections by the industrial commission provided a regular inspection service is maintained or provided by the owners or operators under the following conditions:

(1) The inspection service shall be subject to the approval of the industrial commission.

(2) The boiler or unfired pressure vessel shall be properly installed and not operated at pressures in excess of that determined by the hereinafter orders.

(3) Reports of inspections of all boilers and unfired pressure vessels shall be made to the industrial commission on approved forms. A copy of all reports shall be forwarded to the industrial commission within 30 days after the inspection is made.

**History:** Cr. Register, December, 1956, No. 12, eff. 1-1-57.

**Ind 41.07 Inspection certificates.** (1) An inspection certificate shall be issued by a city, corporation, or company employing the inspector, stating the maximum allowable working pressure after an inspection has been made. This certificate shall be kept on file at all times and made available when called for by a deputy of the industrial commission.

Boiler and Unfired Pressure Vessel Code Register, December, 1956, No. 12

(2) The maximum allowable working pressure, as stated in the certificate of inspection shall not be in excess of that determined by the orders in sections Ind 42.001 to Ind 42.40, inclusive, of this code for boilers and unfired pressure vessels installed prior to January 1, 1957. The maximum allowable working pressure, as indicated by the certificate of inspection or badge plate shall not be in excess of that determined by the orders in sections Ind 41.50 to Ind 41.51 of this code for boilers and unfired pressure vessels built and installed on or after January 1, 1957. All boilers and unfired pressure vessels built for use in Wisconsin on or after January 1, 1957 shall be inspected and stamped in accordance with the orders contained in sections Ind 41.50 to Ind 41.51 of this code.

**History:** Cr. Register, December, 1956, No. 12, eff. 1-1-57.

**Ind 41.08 Certificate of competency for inspectors.** (1) Certificates of competency as boiler and pressure vessel inspectors shall be issued to persons who pass an examination which shall be prescribed and conducted by the industrial commission and which shall determine the fitness and competency of candidates for such certificates of competency. Such certificates shall be renewed annually on application without re-examination.

(2) A certificate of competency issued to an employee of any city, corporation or company shall be annulled upon the termination of his employment with that city, corporation or company by which he was employed at the time of the issuance of the certificate of competency; such certificate of competency may, however, be renewed without a re-examination upon reemployment by a city, corporation or company.

(3) A certificate of competency may be revoked at any time, but the holder of such certificate of competency shall be entitled upon demand, to a hearing before the industrial commission before the revocation of the certificate of competency.

(4) Holders of certificate of competency shall comply with the provisions of this chapter and copies of their reports of inspections shall be forwarded to the industrial commission within 30 days after each inspection.

**History:** Cr. Register, December, 1956, No. 12, eff. 1-1-57.

**Ind 41.09 Stamps and numbers on boilers and unfired pressure vessels.** (1) The owners or operators of a boiler or an unfired pressure vessel, except those covered in section Ind 41.03, shall number each vessel in some convenient and permanent manner.

(2) Boilers and unfired pressure vessels built for use in Wisconsin and installed on or after January 1, 1957 shall comply with the orders in sections Ind 41.50 and Ind 41.51 of this code, and each such boiler or unfired pressure vessel shall be inspected, stamped and a data or report sheet furnished to the industrial commission by the builder, the installer, or the user.

**History:** Cr. Register, December, 1956, No. 12, eff. 1-1-57.

**Ind 41.10 Special type of boilers or unfired pressure vessels.** Builders of special types of boilers or unfired pressure vessels subject to inspection, but not covered by the hereinafter orders shall forward to

the industrial commission blue prints and specifications of the type for approval.

**History:** Cr. Register, December, 1956, No. 12, eff. 1-1-57.

**Ind 41.11 Boiler blow-down equipment.** (1) The blow-down from a boiler or boilers that enters a sewer system or blow-down which is considered a hazard to life or property shall pass through some form of blow-off equipment that will reduce pressure and temperature as required hereinafter.

(2) The temperature of the water leaving the blow-off equipment shall not exceed 140° Fahrenheit.

(3) The pressure of the blow-down leaving any type of blow-off equipment shall not exceed 5 psi.

(4) The blow-off piping and fittings between the boiler and the blow-off tank shall comply with sections Ind 41.50 and Ind 41.51 of this code.

(5) The tank shall be designed in accordance with sections Ind 41.50 and Ind 41.51 of this code for a working pressure of at least one-fourth the maximum working pressure of the boiler to which it is connected.

(6) All blow-off equipment shall be fitted with openings to facilitate cleaning and inspection.

**History:** Cr. Register, December, 1956, No. 12, eff. 1-1-57.

## NEW CONSTRUCTION

**Ind 41.50 Requirements.** All boilers and unfired pressure vessels hereafter installed shall be constructed and installed in accordance with the following sections of the American Society of Mechanical Engineers Boiler and Pressure Vessel Code.

(1) Section I	Power Boilers	1956 Edition*	As amended to January 1, 1957
(2) Section II	Material Specifications	" "	* As amended to January 1, 1957
(3) Section IV	Low Pressure Heating Boilers	" "	* As amended to January 1, 1957
(4) Section V	Miniature Boilers	1952 "	* As amended to January 1, 1957
(5) Section VIII	Unfired Pressure Vessels	1956 "	* As amended to January 1, 1957
(6) Section IX	Welding Qualifications	" "	* As amended to January 1, 1957

\* Note: Copies of the above publications are available for inspection at the office of the Industrial Commission and the Secretary of State's office and the office of the Revisor of Statutes or they may be procured for personal use from the American Society of Mechanical Engineers, 29 West 39th Street, New York 18, N. Y.

It shall further be the policy of the industrial commission to revise and amend this part (Section Ind 41.50 and Ind 41.51 New Construction) from time to time. Anyone using this code is cautioned to check with the industrial commission for the latest releases.

**History:** Cr. Register, December, 1956, No. 12, eff. 1-1-57.

**Ind 41.51 Exceptions to Ind 41.50.** (1) Boilers and pressure vessels not meeting the standard of section Ind 41.50 may be approved by the industrial commission provided the following conditions are met:

(a) The design, material, and workmanship shall be such that they will be operated with an accepted factor of safety.

(b) Complete plans and specifications shall be submitted to, and approved by, the industrial commission before any construction is started.

(c) Vessels constructed under these conditions shall be inspected during construction by an authorized inspector and upon completion, shall be stamped "Wisconsin Special".

(2) The use of a vessel constructed under these conditions shall be limited to the operation and use set forth in the approved application unless additional approval is obtained from the industrial commission.

(3) It is the intent of this code that unfired pressure vessels which have been constructed, inspected, and stamped according to the Interstate Commerce Commission, Regulations Tariff No. 9 effective May 12, 1954 as amended to December 31, 1955, will be considered to meet the requirements of section Ind 41.51 (1) (a), (b), and (c) above, unless stated to the contrary. When such vessels are used in the state of Wisconsin, it shall be the responsibility of the owner of the vessels to have the construction records of the vessels available for inspection by the industrial commission.

**History:** Cr. Register, December, 1956, No. 12, eff. 1-1-57.

## Chapter Ind 42

### BOILER AND UNFIRED PRESSURE VESSEL CODE; EXISTING INSTALLATIONS

Ind 42.001	Application	Ind 42.30	Flanged connections
Ind 42.005	Maximum allowable working pressures	Ind 42.31	Washout and inspection openings
Ind 42.01	Code constructed vessels	Ind 42.32	Manholes
Ind 42.02	Pressure calculations for shells	Ind 42.33	Maintenance
Ind 42.03	Pressure calculations for flat heads and flat surfaces	Ind 42.34	Threaded openings
Ind 42.04	Pressure calculations for dished heads	Ind 42.35	Boiler setting and installation
Ind 42.05	Dished head restrictions	Ind 42.36	Access and firing doors
Ind 42.06	Pressure calculation for furnaces and circular flues	Ind 42.37	Water tube boiler doors
Ind 42.07	Boiler plate thickness	Ind 42.38	Low-water cut-off and water feeder
Ind 42.08	Secondhand boilers and unfired pressure vessels	Ind 42.39	Safety valves, relief valves and connections for unfired pressure vessels
Ind 42.09	Factor of safety	Ind 42.40	Pressure relief devices on unfired pressure vessels
Ind 42.10	Strength of materials	Ind 42.50	Rules and reports
Ind 42.11	Shearing strength of rivets	Ind 42.51	Hydrostatic test
Ind 42.12	Rivet dimensions after driving	Ind 42.52	Design of riveted patches
Ind 42.13	Efficiency of joint	Ind 42.53	Material for riveted patches
Ind 42.14	Ligament between parallel tube holes	Ind 42.54	Workmanship on riveted patches
Ind 42.15	Ligaments between diagonal tube holes	Ind 42.55	Calculations for riveted patches
Ind 42.16	Maximum pressure for cast iron boilers	Ind 42.56	Examples of calculations for riveted patches
Ind 42.17	Safety or relief valves required	Ind 42.59	Procedure
Ind 42.18	Safety valves for low pressure steam, miniature, and power boilers	Ind 42.60	Welders
Ind 42.19	Water-relief valves for hot water boilers	Ind 42.61	Rules for welding
Ind 42.20	Thermometers for hot water boilers	Ind 42.62	Prohibited repairs
Ind 42.21	Water glass	Ind 42.63	Procedure
Ind 42.22	Gage cocks	Ind 42.64	Defective weld
Ind 42.23	Water column piping	Ind 42.65	Stress relieving operations
Ind 42.24	Pressure gages	Ind 42.66	Cracks, permissible welded repairs
Ind 42.25	Stop valves on pressure discharge outlets	Ind 42.69	Corroded surfaces and seal welding
Ind 42.26	Steam mains	Ind 42.74	Re-ending and piecing tubes
Ind 42.27	Bottom blow-off or drain	Ind 42.75	Patches, material
Ind 42.28	Feed pipe	Ind 42.76	Flush or butt welded patches
Ind 42.29	Combustion regulators for boilers	Ind 42.78	Lapped and fillet welded patches
		Ind 42.79	Stays
		Ind 42.80	Additional acceptable repair methods

**Ind 42.001 Application.** The following orders shall apply to unfired pressure vessels or boilers installed prior to January 1, 1957 and secondhand unfired pressure vessels or boilers.\*

\* *Note:* For the installation, operation, and field inspection of vessels used for the storage and transportation of liquid petroleum gases, anhydrous ammonia, and all the refrigerant containing vessels, see the state code which governs. The construction, shop inspection, and repair of these vessels shall be governed by sections Ind 41.50 and Ind 41.51 and Ind 42.50 to Ind 42.80 of this code.

**History:** Cr. Register, December, 1956, No. 12, eff. 1-1-57.

**Ind 42.005 Maximum allowable working pressures.** (1) The maximum allowable working pressure on a boiler or unfired pressure vessel is the safe pressure at which the boiler or unfired pressure vessel may be operated as determined by chapter 42 of this Wisconsin Administrative Code.

(2) No boiler or unfired pressure vessel shall be operated at a pressure in excess of the maximum allowable working pressure for each boiler or unfired pressure vessel.

**History:** Cr. Register, December, 1956, No. 12, eff. 1-1-57.

**Ind 42.01 Code constructed vessels.** Any pressure vessel that has been constructed and stamped in accordance with the rules and regulations of the A.S.M.E. Boiler and Pressure Vessel Code, or other recognized codes, or has the standard stamping of another state that has adopted the standard of construction of the A.S.M.E. Boiler and Pressure Vessel Code, shall be allowed and may be operated at the maximum working pressure stamped on its shell providing the vessel is unaltered, in good working order, and not deteriorated by age or corrosion. For unstamped vessels, the operating pressure shall be determined by using sections Ind 42.02 through Ind 42.16 inclusive.

**History:** Cr. Register, December, 1956, No. 12, eff. 1-1-57.

**Ind 42.02 Pressure calculations for shells.** The maximum allowable working pressure to be allowed on the shell of a boiler or unfired pressure vessel shall be determined from the following formula:

$$P = \frac{T.S. \times t \times E}{R. \times F.S.}$$

where P = maximum allowable working pressure, pounds per square inch,

T.S. = tensile strength of shell plate, pounds per square inch,

t = minimum thickness of shell plates, inches

E = efficiency of longitudinal joint — method of determining which is given in section Ind 42.13.

R = Inside radius of the outside course of the shell,

F.S. = lowest factor of safety allowed by section Ind 42.09.

**History:** Cr. Register, December, 1956, No. 12, eff. 1-1-57.

**Ind 42.03 Pressure calculations for flat heads and flat surfaces.** The maximum allowable working pressure on flat surfaces of boilers and unfired pressure vessels shall be determined by the following formula:

$$P = \frac{T.S. \times t^2}{0.5 \times d^2 \times F.S.}$$

where P = Maximum allowable working pressure, pounds per square inch,

T.S. = tensile strength of plate, pounds per square inch,

t = thickness of plate, inches,

d = diameter of head or shortest unsupported span of head or maximum pitch between stays, inches,

F.S. = lowest factor of safety allowed by section Ind 42.09.

**Note:** No allowance will be made for the holding power of flanges.

**History:** Cr. Register, December, 1956, No. 12, eff. 1-1-57.

Boiler and Unfired Pressure Vessel Code Register, December, 1956, No. 12

**Ind 42.04 Pressure calculations for dished heads.** The maximum allowable working pressure on unstayed dished heads shall be determined by the following formula:

Pressure on concave side (plus head)

$$P = \frac{2 \times T.S. \times E \times t}{8.33 \times L}$$

Pressure on convex side (minus head)

$$P = \frac{2 \times T.S. \times E \times t \times 0.6}{8.33 \times L}$$

where t = thickness of plate, inches

P = maximum allowable working pressure pounds per square inch

T.S. = tensile strength pounds per square inch

L = radius to which the head is dished, measure on the concave side of the head, inches

E = efficiency of weakest joint used in forming the head

(Exclusive of the joint to the shell) for seamless heads E = 1.00.

**History:** Cr. Register, December, 1956, No. 12, eff. 1-1-57.

**Ind 42.05 Dished head restrictions.** Dished heads without skirts or flanges shall not be used for any pressure.

**History:** Cr. Register, December, 1956, No. 12, eff. 1-1-57.

**Ind 42.06 Pressure calculation for furnaces and circular flues.** The maximum allowable working pressure on furnaces of vertical boilers and circular flues shall be determined as indicated in sections Ind 41.50 and Ind 41.51 of this code.

**History:** Cr. Register, December, 1956, No. 12, eff. 1-1-57.

**Ind 42.07 Boiler plate thickness.** (1) The minimum thickness of any boiler plate under pressure shall be ¼ inch except that boiler plate in stayed surfaces shall be 5/16 inch thick minimum.

(2) Seamless shells for miniature boilers may be constructed of 3/16 inch boiler plate.

**History:** Cr. Register, December, 1956, No. 12, eff. 1-1-57.

**Ind 42.08 Secondhand boilers and unfired pressure vessels.** (1) After January 1, 1957, except those covered by section Ind 42.01, all other secondhand boilers and unfired pressure vessels, by which is meant a pressure vessel on which both ownership and location are changed, shall have a factor of safety of at least 6.

(2) Each secondhand pressure vessel shall be inspected and a hydrostatic pressure test applied by an authorized inspector, before it is installed. The hydrostatic pressure test shall be one and one-half times the maximum allowable working pressure.

(3) A secondhand boiler of the lap seam type larger than 36 inches in diameter, shall be limited to a maximum allowable working pressure not exceeding 15 pounds.

(4) Boilers the longitudinal joint on which is exposed to the intense heat of the furnace, shall not be installed for any pressure.

**Note:** The locomotive or inside welt strap will not be considered as strengthening or changing the original type of the boiler joint.

Boiler and Unfired Pressure Vessel Code Register, December, 1956, No. 12

(5) All secondhand pressure vessels when reinstalled must comply with all the orders in sections Ind 41.50 and Ind 41.51 pertaining to fittings, appliances, valves and connections and settings and supports.

(6) A portable boiler which is brought into this state for use, shall be inspected and shall be given a hydrostatic pressure test in accordance with subsection (2) of this section and the maximum allowable working pressure shall be determined by using the correct factor of safety according to section Ind 42.09.

**History:** Cr. Register, December, 1956, No. 12, eff. 1-1-57.

**Ind 42.09 Factor of safety.** Maximum allowable working pressure shall be determined by using a factor of safety of at least 5 except as provided in sections Ind 42.01 and Ind 42.08.

**History:** Cr. Register, December, 1956, No. 12, eff. 1-1-57.

**Ind 42.10 Strength of materials.** When the tensile strength of materials is not known, it shall be taken as 55,000 pounds per square inch for steel and 45,000 pounds per square inch for wrought iron, 30,000 pounds per square inch for copper and 18,000 pounds per square inch for cast iron. The resistance to crushing of mild steel shall be taken as 95,000 pounds per square inch of cross sectional area.

**History:** Cr. Register, December, 1956, No. 12, eff. 1-1-57.

**Ind 42.11 Shearing strength of rivets.** The maximum shearing strength of rivets per square inch of cross-sectional area shall be taken as follows:

	Ultimate Strength Pounds per square inch
Iron rivets in single shear -----	38,000
Iron rivets in double shear -----	76,000
Steel rivets in single shear -----	44,000
Steel rivets in double shear -----	88,000

**History:** Cr. Register, December, 1956, No. 12, eff. 1-1-57.

**Ind 42.12 Rivet dimensions after driving.** When the diameter of the rivet holes in the longitudinal joints of a boiler or unfired pressure vessel is not known, the diameter and cross-sectional area of rivets, after driving, shall be taken from the following tables:

Table 1

Thickness of Plate	1/4"	9/32"	5/16"	11/32"	3/8"	7/16"	13/32"
	0.25"	0.2812"	0.3125"	0.34375"	0.375"	0.375"	0.40625"
Diameter of Rivet after Driving	11/16"	11/16"	3/4"	3/4"	3/4" up to & including 2" pitch	13/16"	13/16"
Cross sectional area of rivet after driving	0.3712 sq. in.	0.3712 sq. in.	0.4418 sq. in.	0.4418 sq. in.	0.4418 sq. in.	0.5185 sq. in.	0.5185 sq. in.

Boiler and Unfired Pressure Vessel Code Register, December, 1956, No. 12

Table 2

Thickness of Plate	7/16"	7/16"	15/32"	1/2"	9/16"	5/8"
	0.4375"	0.4375"	0.46875"	0.5"	0.5625"	0.625"
Diameter of Rivet after Driving	7/8" up to & including 2 1/4" pitch	15/16" over 2 1/4" pitch	15/16"	15/16"	1-1/16"	1-1/16"
Cross sectional area of rivet after driving	0.6013 sq. in.	0.6903 sq. in.	0.6903 sq. in.	0.6903 sq. in.	0.8866 sq. in.	0.8866 sq. in.

**History:** Cr. Register, December, 1956, No. 12, eff. 1-1-57.

**Ind 42.13 Efficiency of joint.** The efficiency of a joint is the ratio which the strength of the joint bears to strength of the solid plate, and, shall be determined as follows:

(1) For riveted joints, calculate according to sections Ind 41.50 and Ind 41.51 of this code using the values stated in sections Ind 42.10, Ind 42.11 and Ind 42.12.

(2) For welded joints, calculate by reference to the following table:

Table 3  
MAXIMUM ALLOWABLE EFFICIENCIES FOR FUSION WELDED JOINTS

Type of Joint	Limitations	Maximum Joint Efficiency Per Cent
Double-Welded Butt Joint	None	80
Single-Welded Butt Joint with Backing Strip	Longitudinal joints not over 1 1/4 inches thick. No thickness limitations on circumferential joints.	80
Single-Welded Butt Joint without Backing Strip	Circumferential joints only not over 5/8 inches thick.	70
Double-Welded Full-Fillet Lap Joint	Longitudinal joints not over 3/8 inches thick. Circumferential joints not over 3/8 inches thick.	60
Single-Welded Full-Fillet Joints with Plug Welds	Circumferential joints only not over 5/8 inches thick and for attachments of heads not over 24 inches outside diameter to shells not over 3/8 inches thick.	50
Single-Full Fillet Joint without Plug Welds	For attachments to heads convex to pressure to shell not over 3/8 inches thick, only with use of fillet weld on inside shell; for attachments to heads having pressure on either side, with fillet weld on outside of head flange only, to shells not over 24 inches inside diameter and not over 1/4 inches required thickness.	50
Forged Weld	None	70
Brazed Steel	None	80
Brazed Copper	None	90

**History:** Cr. Register, December, 1956, No. 12, eff. 1-1-57.

**Ind 42.14 Ligament between parallel tube holes.** When a shell or drum is drilled for tube holes in a line parallel to the axis of the shell or drum, the efficiency of the ligament between the tube holes

Boiler and Unfired Pressure Vessel Code Register, December, 1956, No. 12

shall be determined as shown in sections Ind 41.50 and Ind 41.51 of this code.

**History:** Cr. Register, December, 1956, No. 12, eff. 1-1-57.

**Ind 42.15 Ligaments between diagonal tube holes.** When a shell or drum is drilled for tube holes in a line diagonal with the axis of the shell or drum, the efficiency of the ligaments between the tube holes shall be determined as shown in sections Ind 41.50 and Ind 41.51 of this code.

**History:** Cr. Register, December, 1956, No. 12, eff. 1-1-57.

**Ind 42.16 Maximum pressure for cast iron boilers.** (1) The maximum allowable working pressure on a steam boiler constructed wholly or principally of cast iron shall not exceed 15 pounds per square inch.

(2) The maximum allowable working pressure on boilers, the tubes of which are secured to cast iron headers, shall not exceed 160 pounds per square inch.

**History:** Cr. Register, December, 1956, No. 12, eff. 1-1-57.

**Ind 42.17 Safety or relief valves required.** Every boiler or unfired pressure vessel shall have one or more safety or relief valves set at or below the maximum allowable working pressure. On power boilers the remaining valves may be set at a higher pressure in accordance with section Ind 42.18.

**History:** Cr. Register, December, 1956, No. 12, eff. 1-1-57.

**Ind 42.18 Safety valves for low pressure steam, miniature, and power boilers.** (1) Every boiler shall be provided with safety valve capacity sufficient to discharge all the steam that can be generated without an increase over the maximum allowable working pressure or to which the valve is set, except a 6% increase while the valve is discharging for power and miniature boilers, and a 5 pound per square inch increase while the valve is discharging for low pressure steam boilers.

(2) The steam generating capacity of a boiler in pounds of steam per hour may be determined by one of the following:

(a) Manufacturer's maximum output rating.

(b) Pounds of steam

$$\text{per hour} = \frac{\text{Maximum Btu input per hour} \times 0.75}{1000}$$

(c) Actual evaporation test.

(d) On the basis of boiler heating surface or waterwall heating surface as given in the following table:

**Table 4**  
**MINIMUM POUNDS OF STEAM PER HOUR PER SQUARE FOOT OF SURFACE**

Type of Boiler	Surface	Firetube Boilers	Watertube Boilers
Power Boilers	Boiler heating surface		
	Hand-fired.....	5	6
	Stoker-fired.....	7	8
	Oil-, gas-, or pulverized fuel-fired.....	8	10
	Waterwall heating surface		
	Hand-fired.....	8	8
	Stoker-fired.....	10	12
	Oil-, gas-, and pulverized fuel-fired.....	14	16
Low Pressure Steam and Miniature Boilers	Boiler heating surface		
	Any method of firing.....	5	5*

\*Shall include cast iron boilers.

Note: Compliance with section Ind 42.18-(1) will be required in every case.

(3) On power boilers one or more safety valves on the boiler proper shall be set at or below the maximum allowable working pressure. The remaining valves may be set within a range of 3% above the maximum allowable working pressure, but the range of setting of all of the valves on a boiler shall not exceed 10% of the highest pressure to which any valve is set.

(4) Safety valves which are constructed in accordance with the standards as specified in sections Ind 41.50 and Ind 41.51 of this code are acceptable. Safety valves constructed to other standards may be used if approved by the industrial commission. Dead-weight or weighted-lever safety valves shall not be used.

(5) When 2 or more safety valves are used on a boiler, they may be mounted either separately or as twin valves made by placing individual valves on Y-bases, or duplex, triplex or multiplex valves having two or more valves in the same body casing. The valves shall be made of equal sizes, if possible, and in any event if not of the same size, the smaller of the two valves shall have a relieving capacity of at least 50% of that of the larger valve.

(6) The safety valve or valves shall be connected to the boiler independent of any other steam connection, and attached as close as practical to the boiler, without any unnecessary intervening pipe or fitting. Every safety valve shall be connected so as to stand in an upright position, with spindle vertical, when possible.

(7) The opening or connection between the boiler and the safety valve or valves shall have at least the area of the inlet of the valve or valves. No valve of any description shall be placed between the required safety valve or valves and the boiler, nor on the discharge pipe between the safety valve and the atmosphere. When a discharge pipe is used, the cross-sectional area shall be not less than the full area of the valve outlet or of the total of the areas of the valve outlets discharging thereinto, and shall be as short and straight as possible and so arranged to avoid undue stresses on the valve or valves.

(a) All safety-valve discharges shall be so located or piped as to be carried clear from running boards, platforms, or otherwise carried to a safe location.

(b) Provision for gravity drain shall be made in the discharge pipe, at or near each safety valve, and where water of condensation may collect.

(8) (a) The spring in a safety valve in service for pressures up to and including 250 pounds shall not be used for any pressure more than 10% above or 10% below that for which it was designed. For higher pressures, the spring shall not be used for any pressure more than 5% above or 5% below that for which it was designed.

(b) If the operating conditions of a valve are changed so as to require a new spring for a different pressure, the valve shall be adjusted by the manufacturer or his authorized representative who shall furnish and install a new name plate.

(9) Every superheater shall have one or more safety valves near the outlet. The discharge capacity of the safety valve or valves on an attached superheater may be included in determining the number and size of the safety valves for the boiler, provided there are no intervening valves between the superheater safety valve and the boiler, and provided the discharge capacity of the safety valve or valves on the boiler, as distinct from the superheater, is at least 75% of the aggregate valve capacity required. A soot-blower connection may be attached to the same outlet from the superheater that is used for the safety valve connection.

(10) (a) Every boiler shall have outlet connections for the required safety valve or valves, independent of any other outside steam connection. The area of the boiler opening or openings shall be at least equal to the aggregate areas of inlet connections of all of the safety valves to be attached thereto. An internal collecting pipe, splash plate, or pan may be used, provided the total area for inlet of steam thereto is not less than twice the aggregate areas of the inlet connections of the attached safety valves. The holes in such collection pipes shall be at least  $\frac{1}{4}$  inch in diameter and the least dimension in any other form of opening for inlet of steam shall be  $\frac{1}{4}$  inch.

(b) If safety valves are attached to a separate steam drum or dome, the opening between the boiler proper and the steam drum or dome shall be not less than required by section Ind 42.18-(10)-(a).

(c) When boilers allowed different pressures are connected to a common steam main and all safety valves are not set at the lowest pressure allowed, no safety valve shall be set to exceed by more than 50% the lowest pressure allowed.

(d) For conditions exceeding those specified in the above paragraph, the case shall be referred to the industrial commission for decision.

**History:** Cr. Register, December, 1956, No. 12, eff. 1-1-57.

**Ind 42.19 Water-relief valves for hot water boilers.** (1) Each hot water boiler shall have one or more relief valves of the spring loaded type, without disc guides on the pressure side of the valve. The valves shall be set to relieve at a pressure at or below the maximum allowable working pressure of the boiler.

(2) Relief valves which are constructed in accordance with sections Ind 41.50 and Ind 41.51 of this code are acceptable. Relief valves constructed to other standards may be used if approved by the industrial commission.

(3) Water-relief valves shall be attached directly or as close as possible to the boiler without any unnecessary intervening pipe or fitting. A water-relief valve shall not be connected to an internal pipe in the boiler. Water-relief valves shall be connected so as to stand upright with the spindle vertical when possible.

(4) No shut-off of any description shall be placed between the water-relief valve and the boiler, nor on discharge pipes between such valve and the atmosphere.

(5) When a discharge pipe is used its area shall be not less than the area of the valve or aggregate area based on the nominal diameters of the valves with which it connects. The discharge pipe shall be pitched away from the valve to prevent water from lodging in the upper part of the valve or in the pipe. The water-relief valve shall be so located and piped that there will be no danger of scalding attendants.

(6) The required water-relief valve capacity for any hot water boiler shall be equal to the maximum Btu output at the boiler nozzle or shall be equal to the boiler heating surface multiplied by 5000.

(7) The water-relief valve capacity for each hot water boiler shall be such that the valve or valves will relieve all the pressure that can be generated by the boiler without allowing the pressure to rise more than 3 pounds above the maximum allowable working pressure of the boiler.

(8) Every boiler shall have proper outlet connections for the required water-relief valves, independent of any other connection outside the boiler. The area of the opening or openings shall be at least equal to the aggregate area based on the nominal diameters of all of the water-relief valves with which it connects.

(9) When a hot water supply is heated indirectly by steam in a coil or pipe, the pressure of the steam used shall not exceed the safe working pressure of the hot water tank, and a water-relief valve of at least one inch in diameter, set to relieve at or below the maximum allowable working pressure of the tank, shall be used.

**History:** Cr. Register, December, 1956, No. 12, eff. 1-1-57.

**Ind 42.20 Thermometers for hot water boilers.** Every hot-water boiler shall have a thermometer so located and connected that it shall be easily readable when observing the water pressure or altitude. The thermometer shall be so located that it shall at all times indicate the temperature in degrees Fahrenheit of the water in the boiler, at or near the outlet.

**History:** Cr. Register, December, 1956, No. 12, eff. 1-1-57.

**Ind 42.21 Water glass.** Every low pressure steam, miniature and power boiler shall have at least one water glass, equipped with a valved drain, the lowest visible part of which shall be at or above the following location except that in all cases it shall be so placed as to give adequate protection to those parts of a boiler proper subject to the heat of the products of combustion.



(1) **HORIZONTAL RETURN TUBULAR BOILERS**—not less than 4 inches above the upper surface of the upper row of tubes except when the distance between the uppermost surface of the tubes and the top of steam space is 13 inches or less the distance may be reduced to 2 inches.

(2) **LOCOMOTIVE TYPE BOILERS**—3 inches above the highest part of the crown sheet.

(3) **VERTICAL FIRE TUBE BOILERS**—not less than one-third the length of the tube above the lower tube sheets.

(4) **WATER TUBE BOILERS**—as specified by the manufacturer.

(5) **SCOTCH MARINE TYPE BOILERS**—3 inches above the combustion chamber top.

*Note:* For Dry Back see section Ind 42.21 (1)

(6) **CAST IRON BOILERS**—as specified by the manufacturer.

(7) **OTHER TYPES AND DESIGNS**—for other types and new designs the location shall be fixed by the manufacturer subject to approval by the industrial commission.

**History:** Cr. Register, December, 1956, No. 12, eff. 1-1-57.

**Ind 42.22 Gage cocks.** (1) Every steam boiler, except those exempted below, shall have 3 gage cocks located within the range of the visible portion of the water glass.

(2) The following boilers shall not be required to have gage cocks:

(a) Boilers which do not have a definite water level.

(b) Boilers which have 2 water glasses spaced not less than 2 feet apart on the same horizontal line.

(c) Boilers which have 2 remote water level indicators in addition to the required water glass.

(d) Miniature boilers.

(3) The following boilers shall be required to have only 2 gage cocks:

(a) Low pressure steam boilers.

(b) Locomotive type boilers not over 36 inches in diameter.

(c) Firebox or water leg boilers in which the water heating surface does not exceed 50 square feet.

**History:** Cr. Register, December, 1956, No. 12, eff. 1-1-57.

**Ind 42.23 Water column piping.** (1) No connections shall be placed on pipes connecting the water column to the boiler except connections for damper regulator, feed water regulator, steam gage or drains.

(2) The minimum size of the pipes connecting the water column to a boiler shall be 1 inch. Water-glass fittings or gage cocks may be connected direct to the boiler.

(3) The water connections to the water column of a boiler, when practicable, shall be provided with a cross at each right-angle turn to facilitate cleaning. The water column shall be fitted with a drain cock or drain valve with a suitable connection to the ashpit or other safe point of waste, and if the water connection thereto has a rising bend or pocket which cannot be drained by means of the water column drain, an additional drain shall be placed in this connection in order that it may be blown off to clear any sediment from the pipe.

(4) The steam connection to the water column of a horizontal-return tubular boiler shall be taken from the top of the shell or the

Boiler and Unfired Pressure Vessel Code Register, December, 1956, No. 12

upper part of the head; the water connection shall be taken from the front head at a point not less than 6 inches below the center line of the shell. For the firebox types of boilers, the water connection to the water column shall be taken at a point not less than 6 inches below the lowest water line or as near thereto as possible, and in no case less than 18 inches above the mud ring.

(5) When shut-offs are used on the connections to a water column, they shall be either outside-screw-and-yoke type valves or stop cocks with levers permanently fastened thereto and marked in line with their passage. Where stop cocks are used they shall be of a type with the plug held in place by a guard or gland.

**History:** Cr. Register, December, 1956, No. 12, eff. 1-1-57.

**Ind 42.24 Pressure gages.** (1) (a) Every unfired pressure vessel or boiler shall be provided with a pressure gage connected to the upper part of the vessel and so arranged that the gage cannot be shut off from the vessel except that a shut-off valve or cock shall be placed close to the gage to permit removal for testing while the pressure vessel is in operation.

(b) For steam boilers the gage may also be connected to the water column or water column steam connection. For steam boilers a siphon or equivalent device of sufficient capacity to keep the gage tube filled with water shall be provided.

(2) The dial of the pressure gage shall be graduated to at least one and one-half times the pressure at which the safety or relief valve is set except as follows:

(a) On low pressure steam boilers the gage shall be graduated to at least 30 pounds per square inch.

(b) On hot water boilers the pressure or altitude gage shall be graduated to at least one and one-half times the maximum allowable working pressure.

(3) (a) For low pressure steam boilers the travel of the pointer from zero to 30 pounds per square inch shall be at least 4 inches.

(b) Effective stops shall be provided for the indicating pointer at the lowest and highest pressure points.

(4) The pressure gage dial shall at all times be protected by a transparent cover and shall be kept clear at all times. This gage should be so located as to be readily visible to the operator.

**History:** Cr. Register, December, 1956, No. 12, eff. 1-1-57.

**Ind 42.25 Stop valves on pressure discharge outlets.** (1) Each pressure discharge outlet on unfired pressure vessels, miniature and power boilers, except safety or relief valve outlets, shall be fitted with one or more stop valves, located as near to the pressure vessel as practicable. When 2 or more low pressure steam boilers are connected to a common header, a stop valve shall be provided in the steam outlet of each boiler as near to the boiler as practicable.

(2) When 2 stop valves are placed in the steam connection between a power boiler and the steam main there shall be a free blow drain between them. The discharge of this drain valve shall be visible to the operator while manipulating the valve.

(3) (a) When a stop valve is so located that water can accumulate, drains shall be provided.

Boiler and Unfired Pressure Vessel Code Register, December, 1956, No. 12

(b) Each dry pipe or similar apparatus shall have two holes drilled into it. These holes shall be not less than  $\frac{1}{2}$  inch diameter each and shall be kept open so that the condensation can escape.

(4) Each superheater shall be equipped with at least one drain so located as will most effectively provide for the proper operation of the apparatus.

**History:** Cr. Register, December, 1956, No. 12, eff. 1-1-57.

**Ind 42.26 Steam mains.** Provision shall be made for the expansion and contraction of steam mains connected to boilers, by providing substantial anchorage at suitable points, so that there shall be no undue strain transmitted to the boiler. Steam reservoirs shall be used on steam mains when heavy pulsations of the steam currents cause vibration of the boiler shell plates.

**History:** Cr. Register, December, 1956, No. 12, eff. 1-1-57.

**Ind 42.27 Bottom blow-off or drain.** (1) Connected to the lowest space practicable of each pressure vessel, there shall be a bottom blow-off pipe fitted with a valve or cock. The valves shall be of straightway or angle construction and cocks shall have the plugs held in place with a gland or guard. Straightway globe valves of the ordinary type or valves of such type that dams or pockets can exist for the collection of sediment, shall not be used on such connections.

(2) A surface blow-off shall not exceed  $2\frac{1}{2}$  inch pipe size and the internal and external pipes, when used, shall form a continuous passage, but with clearance between their ends and arranged so that the removal of either will not disturb the other. A properly designed steel bushing or a flanged connection shall be used.

(3) (a) Each boiler shall have a bottom blow-off pipe, fitted with a valve or cock, in direct connection with the lowest water space practicable. The maximum size of pipe and fittings shall be  $2\frac{1}{2}$  inches and the minimum size shall be one inch except that for boilers with 100 square feet of water heating surface or less and low pressure steam boilers the minimum size of pipe and fittings may be  $\frac{3}{4}$  inch. Straightway globe valves of the ordinary type or valves of such type that dams or pockets can exist for the collection of sediment, shall not be used on such connections.

(b) The bottom blow-off pipe for low pressure steam, miniature, and hot water boilers may be connected to return connections which are the same size or larger than the size herein specified. In such case, the blow-off shall be so located that the connection may be completely drained.

(4) A bottom blow-off cock shall have the plug held in place by a guard or gland. The end of the plug shall be distinctly marked in line with the passage.

(5) (a) For power boilers, the bottom blow-off pipe or pipes shall be of wrought iron or steel and shall be at least extra heavy.

(b) The fittings between a power boiler and the required bottom blow-off valve or valves shall be of steel, cast steel or malleable iron and shall be not less than extra heavy construction for pressures not exceeding 150 pounds per square inch.

(c) For pressures exceeding 150 pounds per square inch such fittings shall be of steel construction and not less than extra heavy.

Boiler and Unfired Pressure Vessel Code Register, December, 1956, No. 12

(d) Cast iron pipe and fittings shall not be used in the bottom blow-off pipe between the boiler and the bottom blow-off valve or valves.

(6) (a) On all boilers except those used for traction and portable purposes, when the maximum allowable working pressure exceeds 125 pounds per square inch, each bottom blow-off pipe shall have 2 slow-opening valves, or one slow-opening valve and a cock, and such valves, or valve and cock, shall be at least extra heavy construction. On a boiler having multiple blow-off pipes, a single master valve may be placed on the common blow-off pipe from the boiler, in which case only one valve on each individual blow-off is required. Two independent valves, or a valve and a cock may be combined in one body provided the combined fitting is the equivalent of 2 independent valves, or a valve and a cock, so that the failure of one to operate could not affect the operation of the other.

(b) Every traction and portable boiler shall have a bottom blow-off valve; when the maximum allowable working pressure exceeds 125 pounds per square inch, the blow-off valve shall be at least extra heavy.

(c) For pressures exceeding 200 pounds per square inch the valves or cocks shall be of steel construction.

(d) The blow-off valve or valves shall be the full size of the blow-off pipe.

(7) A bottom blow-off pipe when exposed to direct furnace heat shall be protected by fire brick or other heat resisting material so arranged that the pipe may be inspected.

(8) An opening in the boiler setting for a blow-off pipe shall be arranged to provide for free expansion and contraction.

(9) See section Ind 41.11 for required boiler blow-off equipment.

**History:** Cr. Register, December, 1956, No. 12, eff. 1-1-57.

**Ind 42.28 Feed pipe.** (1) (a) Each low pressure steam, miniature and power boiler shall have the feed pipe fitted with a check valve near the boiler and a stop valve between the check valve and the boiler. Single low pressure steam boiler installations of the gravity return type which do not have a stop valve in the steam outlet line will not be required to have a stop valve in the return pipe.

(b) On low pressure steam boilers, the return pipe loop connection shown in Fig. 1 may be used in place of the check valve.

(2) (a) The feed water shall be introduced into a boiler in such a manner that the water will not be discharged directly against surfaces exposed to gases of high temperature, or to direct radiation from the fire, or close to riveted joints of shell or furnace sheets.

(b) Where horizontal return tubular boilers are fed through the front a boiler bushing or its equivalent shall be used and the feed water shall discharge at about three-fifths the length of the boiler from the front head, and above the second row of tubes from the top.

(3) When 2 or more power boilers are fed from a common source, there shall be a globe or regulating valve on the branch to each boiler, between the check valve and the source of supply. When 2 or more low pressure steam boilers, using a gravity return system are fed from a common source, one check valve may be placed on the main return pipe with a stop valve on the branch return to each boiler. Wherever globe valves are used on feed piping, the inlet shall be under the disc of the valve.

Boiler and Unfired Pressure Vessel Code Register, December, 1956, No. 12

EQUALIZING LOOP.  
CONNECT AS DIRECT AS POSSIBLE.  
SEE TABLE BELOW FOR SIZE.

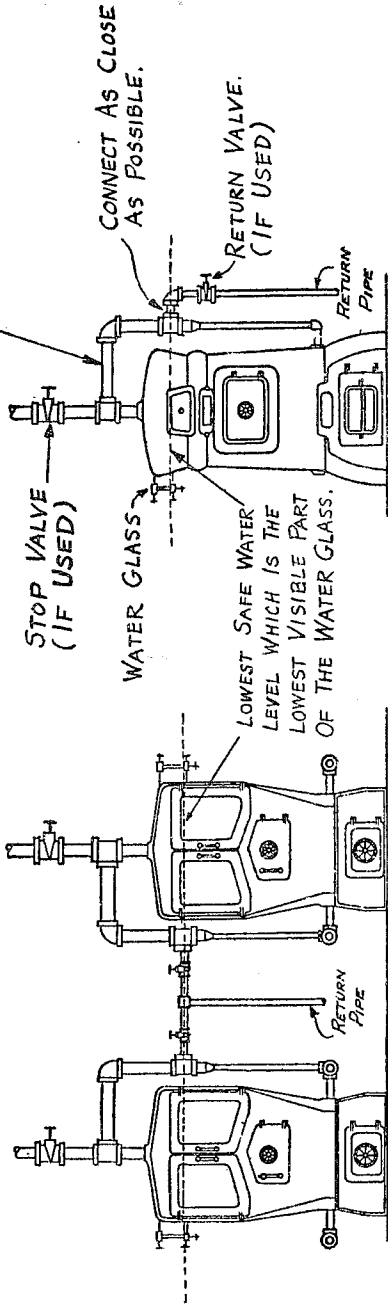

GRATE AREA, OR Sq. Ft.	SAFETY VALVE CAP, LBS/HR	EQUALIZING LOOP SIZE, INCHES
4 OR LESS	250 OR LESS	1 1/2
OVER 4 TO 15	251 TO 2000 INC.	2 1/2
OVER 15	OVER 2000	4

Fig. 1

RETURN PIPE LOOP CONNECTION

(4) (a) Means shall be provided for feeding a boiler against the maximum allowable working pressure or the pressure at which the safety valve is set to blow.

(b) Where a source of feed is available at a sufficient pressure to feed the boiler against a pressure 6% higher than that at which the safety valve is set to blow, this may be considered one of the means.

(5) Every boiler and its piping system shall be provided with a water supply line from an outside source of water supply in order to replace the water leaving the system through leakage, process work, or other reasons.

(a) A stop and check valve shall be provided in the water supply line with the stop valve closest to the boiler.

(b) On low pressure steam and hot water boilers, the water supply line shall be connected to the boiler return or feed piping system and not directly to the boiler.

(c) On low pressure steam, miniature, and hot water boilers, the water supply line pressure shall be high enough to feed the boiler or the system against the maximum allowable working pressure of the boiler.

(6) A heater for oil or other liquid harmful to boiler operation shall not be installed directly in the steam or water space within a boiler. Where an external type heater for such service is used, positive means shall be provided to prevent the introduction into the boiler of oil or other liquid harmful to boiler operation.

**History:** Cr. Register, December, 1956, No. 12, eff. 1-1-57.

**Ind 42.29 Combustion regulators for boilers.** (1) A temperature combustion regulator, which will control the rate of combustion to prevent the temperature of the water from rising above 250° Fahrenheit at or near the outlet, or a thermostatic device which will relieve the pressure on the boiler when the temperature exceeds 250° Fahrenheit, shall be used on all hot water boilers.

(2) When a pressure combustion regulator is used on a steam boiler, it shall operate to prevent the steam pressure from rising above the maximum allowable working pressure for the boiler.

**History:** Cr. Register, December, 1956, No. 12, eff. 1-1-57.

**Ind 42.30 Flanged connections.** Openings in boilers having flanged connections shall have the flanges conform to the American standard for the corresponding drilling for bolts or studs. Steel outlet nozzles and flanges may be riveted or welded to the shell. Cast iron outlet nozzles or flanges will be permitted only on low pressure steam or hot water boilers and can be attached to the shell only by riveting.

**History:** Cr. Register, December, 1956, No. 12, eff. 1-1-57.

**Ind 42.31 Washout and inspection openings.** (1) All boilers or unfired pressure vessels shall be provided with suitable manhole or handhole openings, except special types where they are manifestly not needed or used.

(2) All horizontal fire tube boilers shall be required to have the following manhole or handhole openings: (a) A manhole in the front head below the tubes for: 1. Horizontal return tubular power boilers over 54 inches in diameter.

2. Horizontal return tubular low pressure steam or hot water boilers over 60 inches in diameter.

3. For smaller boilers a handhole may be used in place of the manhole.

(b) A manhole in the upper part of the shell or head for: 1. Horizontal return tubular, fire box and locomotive power boilers over 48 inches.

2. Scotch marine power boilers over 54 inches in diameter.

3. Low pressure steam boilers over 60 inches in diameter.

4. For smaller boilers a handhole may be used in place of the manhole.

(c) Locomotive and fire box boilers shall also have the following handhole or washout openings: 1. One at each of the four corners of the lower portion of the water leg.

2. One in the front head at or about the line of the crown sheet.

3. One near the throat sheet of power boilers where possible.

4. One in the rear head of power boilers below the tubes.

(3) (a) A vertical fire tube boiler, except boilers 24 inches or less in diameter, shall have not less than 4 handholes located as follows: Two in the shell at or about the line of the crown sheet or lower tube sheet; 2 in the shell at the lower part of the water leg.

(b) Vertical fire tube boilers 24 inches or less in diameter shall have three one inch diameter washout plugs except that boilers not exceeding 12 inches internal diameter having less than 10 square feet of water heating surface need not have more than 2 such washout plugs, one of which may be used for the attachment of the bottom blow-off valve. The threads of the washout plugs shall be of non-ferrous material.

(4) All unfired pressure vessels, in other than non-corrosive service, 18 inches in diameter or over shall be provided with one of the following washout or inspection opening combinations: 2 handholes in the shell or heads, a manhole, or 2 or more plugged threaded openings of 2 inches in diameter.

(5) All unfired pressure vessels, in other than non-corrosive service, less than 18" and over 12" in diameter must be provided with at least 2 handholes, or 2 inspection holes, properly located for inspection, the inspection holes to be not less than 1½" pipe size, unless the pressure vessel has a removable head or cover plate. For vessels 12" and under inspection openings may be omitted.

(a) Vessels not over 16" in inside diameter that are installed so that they must be disconnected from an assembly to permit inspection, need not be provided with openings for inspection only, if there are at least two removable pipe connections not less than 1½" pipe size.

(6) Where handholes are provided, such handholes shall not be less than 2½ inches by 3½ inches in size.

(7) Washout plugs, except for vertical fire tube boilers, shall be not less than 1½ inch pipe size and shall have threads of non-ferrous materials.

(8) Every cast iron boiler shall be provided with washout openings to permit the removal of any sediment that may accumulate therein. Washout openings may be used for return pipe connection if the washout plug is placed in a tee so that the plug is directly opposite and as close as possible to the opening in the boiler.

**History:** Cr. Register, December, 1956, No. 12, eff. 1-1-57.

Boiler and Unfired Pressure Vessel Code Register, December, 1956. No. 12

**Ind 42.32 Manholes.** Where manholes are provided, such manholes shall be not less than 11 inches by 15 inches, or 10 inches by 16 inches in size. A circular manhole opening shall be not less than 15 inches in diameter. Any opening, the greatest dimension of which exceeds 6 inches, in the shell of an unfired pressure vessel shall be reinforced in accordance with rules for manholes. No manholes or handholes are required on unfired pressure vessels which have removable heads or cover plates.

**History:** Cr. Register, December, 1956, No. 12, eff. 1-1-57.

**Ind 42.33 Maintenance.** (1) All boilers or unfired pressure vessels shall be installed and maintained in such a manner as to prevent excessive corrosion or deterioration.

(2) The inspector shall note conditions during the internal inspection, external inspection or hydrostatic pressure test and order such changes or repairs as will place the pressure vessel in a safe working condition.

**History:** Cr. Register, December, 1956, No. 12, eff. 1-1-57.

**Ind 42.34 Threaded openings.** (1) All pipe threads shall conform to the American Pipe Thread standard and all connection one inch pipe size or over shall have not less than the number of threads given in Table 5. For smaller pipe connections there shall be at least 4 threads in the opening.

(2) If the thickness of the shell of the boiler or pressure vessel is not sufficient to give such number of threads a construction shall be employed which will provide at least the required number of threads.

**History:** Cr. Register, December, 1956, No. 12, eff. 1-1-57.

**Table 5**  
**MINIMUM NUMBER OF PIPE THREADS FOR CONNECTIONS**  
**TO BOILERS OR PRESSURE VESSELS**

Size of pipe connections, inches-----	1 and 1¼	1½ and 2	2½ to 4 incl.	4½ to 6 incl.	7 and 8	9 and 10	12
Number of threads per inch-----	11½	11½	8	8	8	8	8
Minimum number of threads required in opening-----	4	5	7	8	10	12	13
Minimum thickness of material required to give above number of threads, inches-----	0.348	0.435	0.875	1	1.25	1.5	1.6265

**Ind 42.35 Boiler setting and installation.** (1) A horizontal return tubular boiler over 72 inches in diameter shall be supported from steel hangers by the outside suspension type of setting, independent of the boiler side walls. The hangers shall be so designed that the load is properly distributed between the rivets attaching them to the shell and so that no more than 2 of these rivets come in the same longitudinal line on each hanger. The distance girthwise of the boiler from the centers of the bottom rivets to the center of the top rivets attaching the hangers shall be not less than 12 inches. The other riv-

Boiler and Unfired Pressure Vessel Code Register, December, 1956. No. 12

ts used shall be spaced evenly between these points. If more than 4 hangers are used they shall be set in 4 pairs.

(2) A horizontal return tubular boiler over 54 inches and up to and including 72 inches in diameter, shall be supported by the outside suspension type of setting, or at 4 points by not less than 8 steel or cast iron brackets, set in pairs. A horizontal return tubular boiler up to and including 54 inches in diameter shall be supported by the outside suspension type of setting, or by not less than 2 steel or cast iron brackets on each side.

(3) Lugs or hangers, when used to support a boiler of any type shall be properly fitted to the surfaces to which they are attached. If riveted the shearing and crushing stresses on the rivets used for attaching the lugs or hangers shall not exceed 8% of the strength given in section Ind 42.11. Where it is impractical to use rivets, studs with not less than 10 threads per inch may be used. In computing the shearing stress, the area at the bottom of the thread shall be used. Strength welding may be used, if done in accordance with sections Ind 41.50 and Ind 41.51 of this code.

(4) Wet bottom stationary boilers shall have a space of not less than 12 inches between the bottom of the boiler and the floor line, with access for inspection.

(5) The upper surface of the fire grate of an internally fired boiler of the open bottom locomotive, vertical fire tube or similar type, shall not be below the water space in the water leg, except where the rivets at the bottom of the water leg are protected from the action of the fire and products of combustion.

**History:** Cr. Register, December, 1956, No. 12, eff. 1-1-57.

**Ind 42.36 Access and firing doors.** The minimum size of an access door to be placed in a boiler setting shall be 12 inches by 16 inches or equivalent area, 11 inches to be the least dimension in any case.

**History:** Cr. Register, December, 1956, No. 12, eff. 1-1-57.

**Ind 42.37 Water tube boiler doors.** A water tube boiler shall have the firing doors, furnace inspection doors and clinker doors of the inward opening type, unless such doors are provided with latching or fastening devices or otherwise so constructed as to prevent them, when closed, from being blown open by pressure on the furnace side.

**History:** Cr. Register, December, 1956, No. 12, eff. 1-1-57.

**Ind 42.38 Low-water cut-off and water feeder.** (1) Every low pressure steam or power boiler which is automatically fired shall be equipped with an automatic low-water fuel cut-off or other device which will perform a similar function, so located as to automatically cut off the fuel supply when the surface of the water falls to the lowest safe water line. If a water feeding device is installed, it shall be so constructed that the water inlet valve cannot feed water into the boiler through the float chamber and so located as to supply the requisite feed water. The lowest safe water line shall be not lower than the lowest visible part of the water glass.

(2) Such a fuel or feed water control device may be attached direct to a boiler or to the tapped openings provided for attaching a water glass direct to a boiler, provided that such connections from the boiler are non-ferrous tees or Y's not less than ½ inch pipe size be-

tween the boiler and the water glass so that the water glass is attached direct and as close as possible to the boiler; the straightway tapping of the Y or tee to take the water glass fittings, the side outlet of the Y or tee to take the fuel cut-off or water-feeding device. The ends of all nipples shall be reamed to full size diameter.

(3) Designs embodying a float and float bowl shall have a vertical straightway valved drain pipe at the lowest point in the water equalizing pipe connections by which the bowl and the equalizing pipe can be flushed and the device tested.

**History:** Cr. Register, December, 1956, No. 12, eff. 1-1-57.

**Ind 42.39 Safety valves, relief valves and connections for unfired pressure vessels.** (1) Safety valves which are constructed in accordance with the standards of sections Ind 41.50 and Ind 41.51 of this code are acceptable. Safety valves constructed to other standards may be used if approved by the industrial commission.

(2) Each safety or relief valve shall have a full size direct connection to the pressure vessel. When an escape pipe is used it shall be full sized and fitted with an open drain, to prevent water lodging in the upper part of the safety or relief valve or escape pipe. When a pressure vessel is fitted with 2 safety or relief valves on one connection, this connection to the pressure vessel shall have a cross-sectional area equal to or greater than the combined area of the 2 safety or relief valves. No valve of any description shall be placed between the safety or relief valve and the pressure vessel, nor on the escape pipe between the safety or relief valve and the atmosphere.

(3) When an elbow is placed on a safety or relief valve escape pipe it shall be located close to the safety or relief valve outlet, or the escape pipe shall be securely anchored and supported.

**History:** Cr. Register, December, 1956, No. 12, eff. 1-1-57.

**Ind 42.40 Pressure relief devices on unfired pressure vessels.** (1) **VESSELS FOR CONTAINING GASES.** When the capacity of the safety valve on an existing tank for containing gases is not known, the relieving capacity of such safety valve shall be determined from Table 6. Such safety valves shall not exceed 4 inches in diameter.

(2) **VESSELS SUPPLIED THROUGH PRESSURE REDUCING VALVES.** The following formula shall be used for determining the sizes of safety and relief valves on unfired pressure vessels such as pressure cookers, indirect hot water heaters, equipment in heating systems, etc., which are supplied through pressure reducing valves from boilers carrying a higher steam pressure:

$$RVC = \frac{1}{3} \times OC \times VSPA$$

where RVC = relief valve capacity, lbs. of steam per hour.

OC = orifice capacity, lbs. of steam per hour per square inch  
(See Table 7)

VSPA = valve size pipe area, sq. in. (See Table 8)

**Note:** Most pressure reducing valves are arranged with a valved by-pass which also acts as a potential steam source hazard in case the by-pass is left open. Where such valved by-pass is used, the following formula shall be used to determine the steam flow rate through the by-pass:

$$RVC = \frac{1}{2} \times OC \times BPA$$

where RVC = relief valve capacity, lbs. of steam per hour.

OC = orifice capacity, lbs. of steam per hour per square inch.  
(See Table 7)

BPA = by-pass pipe area, sq. inch. (See Table 8)

**Table 6**  
**MAXIMUM FREE AIR SUPPLIED IN CUBIC FEET PER MINUTE FOR DIFFERENT SIZES OF SAFETY VALVES AT STATED PRESSURES**

Diameter of Valve (inches)	Gage pressure, pounds							
	50	100	150	200	250	300	350	400
1/4								53
1/2	20	32	42	51	59	67	74	111
3/4	37	59	78	96	112	127	141	176
1	58	94	124	152	178	202	224	248
1 1/4	84	135	180	221	259	293	325	
1 1/2	114	186	248	302	354	400	444	
2	189	306	410	501	592	668	741	
2 1/2	232	457	613	750	880	998	1114	
3	393	688	856	1050	1230	1398	1557	

Diameter of Valve (inches)	Gage Pressure, pounds							
	500	600	800	1,000	1,200	1,600	2,000	2,400
1/4	61	70	84	97	109	128	147	167
1/2	129	147	177	205	230	270	304	330
3/4	224	232	242	346	386	423	474	518
1	236	324	390	450	500	586		
1 1/4	374		509					
1 1/2	472		634					
2								
2 1/2								
3								

Other and Unfired Pressure Vessel Code

Register, December, 1956, No. 12

**Table 7**  
**ORIFICE RELIEVING CAPACITIES, LB. PER HR. PER SQ. IN., FOR DETERMINING THE PROPER SIZE OF RELIEF VALVES USED ON LOW PRESSURE SIDE OF REDUCING VALVES**

Outlet Pressure, psi	Pressure-reducing valve inlet pressure, psi								
	125	100	85	75	60	50	40	30	25
110	4550								
100	5630								
85	6640	4070							
75	7050	4980	3150						
60	7200	5750	4540	3520					
50	7200	5920	5000	4230	2680				
40	7200	5920	5140	4630	3480	2470			
30	7200	5920	5140	4630	3860	3140	2210		
25	7200	5920	5140	4630	3860	3340	2580	1485	
15	7200	5920	5140	4630	3860	3340	2830	2320	1800
10	7200	5920	5140	4630	3860	3340	2830	2320	2060
5	7200	5920	5140	4630	3860	3340	2830	2320	2060

Boiler and Unfired Pressure Vessel Code

Register, December, 1956, No. 12

The larger of the relief valve capacities calculated by the above two formulas shall be used for selecting the relief valve for the vessel.

*Example:*

Suppose a high pressure boiler operating at 125 psi distributes steam to a series of 40 psi A.S.M.E. constructed retorts through a 1/2 inch size pressure reducing valve provided with a glove-valved inch by-pass. Determine the proper A.S.M.E. relief valve protection or the retorts. Utilizing data in Tables 7 and 8 and the first of the two formulas above:

$$V = 1/3 \times 7200 \times 2.04 = 4896 \text{ Lbs. Steam per hour}$$

Checking the by-pass steam flow according to the second formula gives:

$$V = 1/2 \times 7200 \times 0.86 = 3100 \text{ Lbs. Steam per hour}$$

The potential steam flow through the pressure reducing valve is 4896 lbs. per hour rated capacity or  $4896 \times 1000$  or 4,896,000 Btu per hour.

**History:** Cr. Register, December, 1956, No. 12, eff. 1-1-57.

**Table 8**  
**INTERNAL PIPE AREA**

Nominal pipe size, inches	Standard		
	Actual external diameter, inches	Approx. internal diameter, inches	Approx. internal area, square inches
3/8	0.675	0.49	0.19
1/2	0.840	0.62	0.30
3/4	1.050	0.82	0.53
1	1.315	1.05	0.86
1 1/4	1.660	1.38	1.50
1 1/2	1.900	1.61	2.04
2	2.375	2.07	3.36
2 1/2	2.875	2.47	4.78
3	3.5	3.07	7.39
3 1/2	4.0	3.55	9.89
4	4.5	4.03	12.73
5	5.563	5.05	19.99
6	6.625	6.07	28.89
8	8.625	8.07	51.15
10	10.750	10.19	81.55
12	12.750	12.09	114.80

**Note:** In applying these rules the area of the pipe is always based upon standard weight pipe and the inlet size of the pressure-reducing valve.

**REPAIRS, ADDITIONS OR ALTERATIONS**

**Ind 42.50 Rules and reports.** (1) Repairs, additions or alterations to any boiler or pressure vessel or their fittings, settings or appurtenances shall be made according to the rules for existing installations or repairs of this code. In the absence of specific rules the rules for new construction shall apply. Permission shall be obtained from the industrial commission for cases not specifically covered in any section of this code.

(2) Manufacturers, owners, or contractors who make major repairs\* in accordance with these rules shall furnish the industrial commission with a report of every such major repair within 30 days after completion thereof. The report shall be signed by the authorized inspector who inspected the repair. The owner of the equipment on which major repairs were made shall retain a copy of the report in his files for review by an authorized inspector. The form to be used for the report shall contain the information shown in the following example:

\* See section Ind 41.001 (12).

**Record of Riveted or Welded Major Repairs**

This is to certify that the major repair made by or under the direction of the undersigned on \_\_\_\_\_  
(Date of Repair)

and consisting of \_\_\_\_\_  
(Description of Repair)

\_\_\_\_\_ (On Boiler No.) \_\_\_\_\_ (On Unfired Pressure Vessel No.)

located in the plant of \_\_\_\_\_  
(Name of Pressure Vessel Owner)

\_\_\_\_\_ (Address of Plant)

was made in accordance with the requirements of the Wisconsin Industrial Commission for repairs by riveting or fusion welding to power or miniature boilers and unfired pressure vessels. The welding

was done by \_\_\_\_\_  
(Fill in only if a fusion welded repair)  
who has made the test requirements of said rules.

Signed \_\_\_\_\_

Dated at \_\_\_\_\_ On \_\_\_\_\_

\_\_\_\_\_ Employed by \_\_\_\_\_ Authorized Inspector

**History:** Cr. Register, December, 1956, No. 12, eff. 1-1-57.

**Ind 42.51 Hydrostatic test.** Upon completion of repairs, a hydrostatic test of 150% of the maximum allowable working pressure shall be applied and the patch seams should be tight at this pressure.

**History:** Cr. Register, December, 1956, No. 12, eff. 1-1-57.

**Ind 42.52 Design of riveted patches.** It is the purpose of sections Ind 42.52 to Ind 42.58 covering the application of riveted patches, to restore to the weakened portion of the shell or head enough of its initial strength to permit the boiler to operate at its original working

Boiler and Unfired Pressure Vessel Code Register, December, 1956, No. 12

pressure. This involves calculations of the patch joints based on the shape and location of the patch. The rules herein given enable the efficiency of the patch joints to be readily determined. It is required that when riveted patches are considered necessary or desirable, they shall be applied under the following rules.

(1) The first thing that shall be taken into consideration when proceeding with the design of a patch is whether or not all of the end stress is to be carried by the patch; in other words, whether the ends are supported or unsupported. In drums of water tube boilers, the full end wise stress has to be carried by the shell plates and the patch seams, whereas in shells of horizontal tubular boilers some of the end wise stress is carried by the through rods, tube or flues, and consequently there is less stress on the shell and patch seams. It is evident then that a patch in the one case need not have the same width for a given length as in the other case. In other words, different constants may be used in determining the width. Tables 10 and 11 take into account these 2 different conditions.

(2) The angle of a patch when laid out in the flat does not change when formed to the curvature of the boiler, therefore, the diameter of the boiler does not need to be taken into consideration in the design when the provisions of item (3) are met.

(3) (a) A patch shall be laid out in the flat and then carefully formed to accurately fit the contour of the boiler where it is to be applied.

(b) Patches shall be of the same thickness as the original thickness of the plate they replace.

(4) (a) Seams exposed to the products of combustion shall be single riveted lap construction.

(b) Seams not exposed to the products of combustion shall be double riveted or constructed similar to the original seams of the boiler.

(5) (a) Patches exceeding 24 inches in length shall have the proper width as determined by the rules herewith.

(b) Patches 24" or less in length shall be triangular, crescent, diamond or oval in form and the width shall be at least twice the length.

(6) (a) If it is found that a patch would extend extremely high it may be shortened in width to the extent that no more than 4 rivets will be in a longitudinal line, as shown in Figure 3.

(b) Likewise, to avoid the necessity of calking in sharp corners, a patch may be shortened in width to the extent that no more than 4 rivets will be in a longitudinal line, as shown in Figure 3.

(7) (a) If it is found that a patch would have to be 60 inches or more in length consideration shall be given to the use of a sheet having a width equivalent to  $\frac{1}{2}$  of the circumference of the boiler and the longitudinal seam shall be of a design similar to the design of the original seam of the boiler.

(b) In designing patches, it is not necessary to deal with angles in the term of degrees, but merely with the dimensions of the triangles forming a patch. The relation between the length and width provides certain fixed constants that have been tabulated and designated as Tables 10 and 11. The constant is the figure by which the length shall be multiplied to determine the width.

Fig. 2  
TRIANGULAR PATCH

At girth seam on bottom of boiler (inside) as viewed from outside of boiler

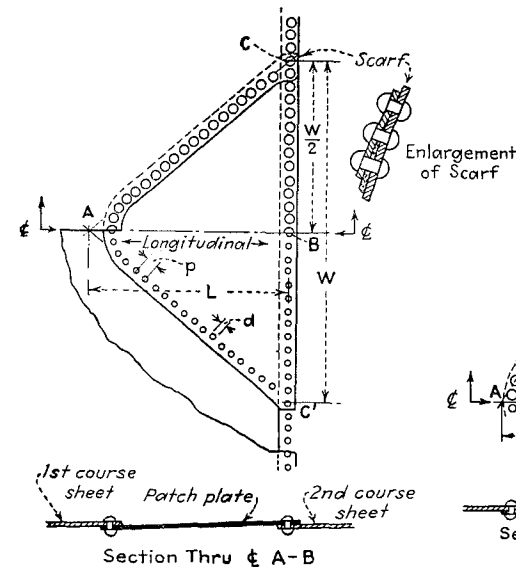

Fig. 3

Showing how patch may be shortened girthwise provided no more than 4 rivets are in a line parallel with the longitudinal seam.

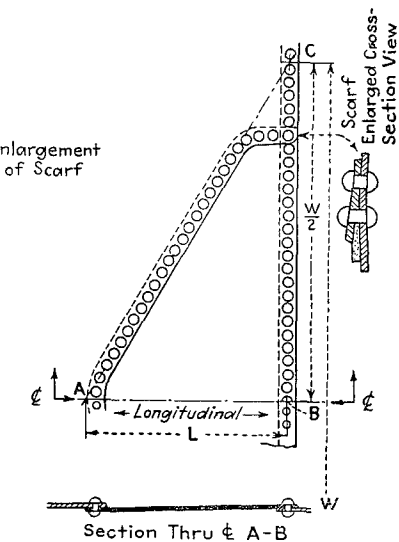

Fig. 4  
DIAMOND SHAPE PATCH  
At centre of sheet (inside)

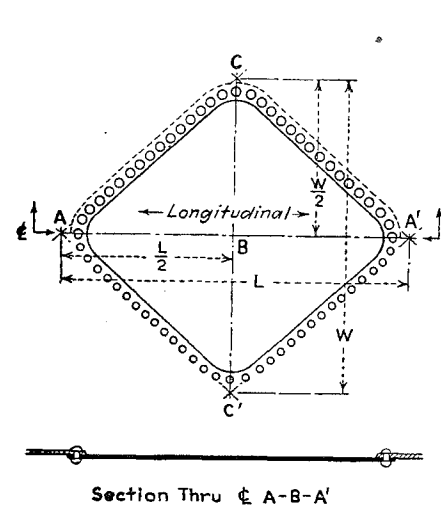
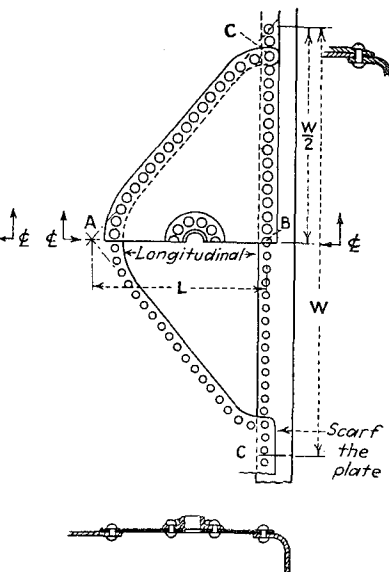

Fig. 5  
TRIANGULAR PATCH  
At head seam and blow-off on bottom of boiler (outside)





(c) If a patch is diamond in shape, it is considered equivalent to triangular patches and half the total length is used in determining the width.

(d) As the angle of a patch as laid out when flat does not change when formed to the curvature of the boiler, the diameter of the boiler does not have to be taken into consideration in the design.

(8) (a) In laying out new patches over 24 inches long, it is recommended that they be triangular or diamond in shape, as may be required for the particular job, with definite straight line sides, but with the corners properly rounded out to permit proper calking, as illustrated in Figures 2, 3, 4, and 5.

(b) Where the length designated as "L" and the width designated as "W" is measured is also shown in Figures 2, 3, 4, and 5.

(9) (a) Rivets, patch bolts or staybolts may be used in "riveted" seams surfaces that are stayed or braced, provided at least one rivet or patch bolt is used between adjacent staybolts. The riveting shall be completed first.

(b) Rivet holes may be countersunk in patches on shells that have rounded heads, if desired, without materially affecting the calculated strength of the patch. The angle of the chamfer with center line of the rivet hole shall not exceed 45 degrees and the depth shall not exceed half the thickness of the plate.

(10) Where patches have already been applied the problem is to determine the effective diagonal efficiency. If the seams are all rounded, that is to say, the patch is crescent or oval in shape, the length "L" shall be taken between the center of the extreme two rivets on the longitudinal center line and the width "W" between the center of the extreme two rivets on the girthwise center line, as illustrated in Figures 6 and 7.

History: Cr. Register, December, 1956, No. 12, eff. 1-1-57.

Fig. 6  
CRESCENT PATCH  
At Girth Seam

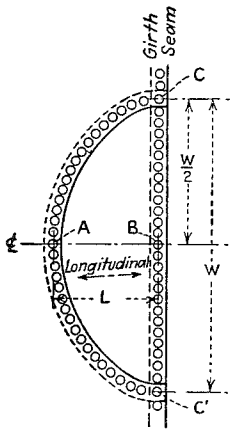
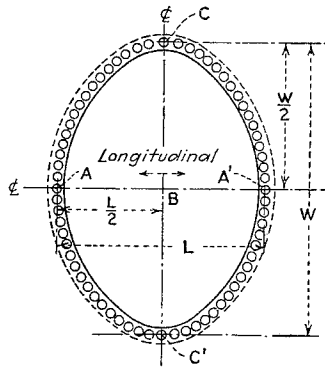

Fig. 7  
OVAL PATCH



Ind 42.53 Material for riveted patches. (1) Patch material shall be either fire box or flange steel. Structural steel shall not be used. The repair shop shall produce a copy of the manufacturer's mill test report of the material to be used.

(2) The material shall contain the steelmaker's brand. If only part of a plate is required and this part does not contain the brand, the brand shall be transferred to the patch plate in the presence of an authorized boiler inspector or a representative of the plate manufacturer, before the plate is cut. Rivets, patch bolts, or staybolts shall be of material of standard quality.

History: Cr. Register, December, 1956, No. 12, eff. 1-1-57.

Ind 42.54 Workmanship on riveted patches. (1) All patch plates shall be placed inside a boiler shell or drum where exposed to the products of combustion and where deposits would be pocketed. Where a patch plate includes the part to which the blow-off is attached, the patch shall be placed on the outside.

(2) All defective material exposed to the products of combustion shall be removed and properly trimmed to provide for neat workmanship in attaching the patch. Defects not exposed to the products of combustion need not be removed unless necessary to insure a workmanlike job.

(3) A distorted sheet which is to be patched shall first be set back straight as much as possible before proceeding with the cutting out of the plate so that the patch may be kept as small as possible.

(4) The edge of a patch shall be beveled by planing, chipping, or gas cutting before applying it to the boiler. Rivets shall be driven by gun, if at all possible.

(5) All rivet holes shall be drilled full size or the holes may be punched not to exceed 1/4 inch less than full size for plates over 5/16 inch, and 1/8 inch less for plates 5/16 inch or less in thickness, and then reamed to full size with patch in place. Rivet holes are usually 1/16 inch greater in diameter than the normal diameter of the rivet but a 1/32 inch difference is preferable when the rivets are of uniform size.

(6) If seal welding is used, it shall be laid in a single bead with a throat thickness not less than 3/16 inch, nor more than 5/16 inch. The patch shall be tight before seal welding under a hydrostatic test equal to the operating pressure.

(7) Where 3 plates have to be lapped at the corners of a patch, the middle plate shall be carefully scarfed to a feather edge the entire width of the lap, as shown in Figure 2.

History: Cr. Register, December, 1956, No. 12, eff. 1-1-57.

Ind 42.55 Calculations for riveted patches. (1) First the length L of the patch shall be determined. The dimension is, of course, governed by the area of the defect. Next, the normal efficiency, e, of the single-riveted seam that is to be used in the patch shall be determined from Table 9. This is governed by the thickness of plate and diameter of rivet holes.

(2) After determining the length that a patch shall be, the next step is to determine what the width girthwise shall be. This is found by multiplying the length by the constant, C, as shown in Table 10 or 11, depending upon the type of boiler to be repaired. These tables

Boiler and Unfired Pressure Vessel Code Register, December, 1956, No. 12

ive a constant C for a given efficiency, e, of patch and efficiency, E, f longitudinal seam.

(3) To determine the longitudinal efficiency of an existing patch, L nd W shall be measured, also the pitch, p, and diameter of rivet, d. 7 divided by L will give the constant C. Table 9 will give e. Then nder e in Table 10 or 11, depending upon the type of boiler to be paired, find the constant C. Then whatever E at the left is found the longitudinal or allowed efficiency of the patch seam (See sec-on Ind 42.56).

Table 9  
EFFICIENCIES OF SINGLE-RIVETED SEAMS

Plate Thickness, t	Rivet Hole Diameter, d	Pitch of Rivets, p	Efficiency of Seam, e
1/4	11/16	1 7/8	63.3
9/32	3/4	1 1/2	60.0
5/16	3/4	1 1/2	60.0
11/32	13/16	1-15/16	58.0
3/8	13/16	1-15/16	57.0
13/32	7/8	2-1/16	57.5
7/16	15/16	2 3/4	56.0
15/32	15/16	2 1/2	55.5
1/2	1	2 3/4	55.7
9/16	1-1/16	2 3/8	53.0
19/32	1-1/16	2 3/4	52.3
5/8	1-1/16	2 1/2	50.5
21/32	1 1/8	2-5/16	51.4
11/16	1 1/8	2-5/16	51.4

Tensile strength assumed at 55,000 psi and shearing strength at 44,000 psi.  
History: Cr. Register, December, 1956, No. 12, eff. 1-1-57.

Ind 42.56 Examples of calculations for riveted patches. (1) DE-GN OF PATCH FOR HORIZONTAL-TUBULAR BOILER. (a) A patch is to be aced in the fire sheet of a horizontal-return tubular boiler having ell plate 7/16 inch thick, a longitudinal seam efficiency of 74%, nd a length of patch of 36 inches. Find the width W of patch be applied so that there will not be any reduction in pressure, using single-riveted seam of normal design.

(b) Referring to Table 9, it is found that a 7/16 inch plate with 5/16 inch diameter rivet holes, pitch 2 3/4 inch, gives a seam effi-ency of 56%.

(c) Referring to Table 10, E-74 and e-56 give a constant C-1.75; hen width W = L x C = 36 x 1.75 = 63 inches.

(2) PRESSURE ALLOWANCE ON AN EXISTING PATCH FOR HORIZONTAL-TUBULAR BOILER. (a) A crescent shape patch has already been installed a horizontal-tubular boiler. It is found to be 30 inches long and 3 inches wide. The seam is noted to be single-riveted with 13/16 ch riveted holes pitch 1-15/16 inch. The boiler shell plate is 3/8 inch ick. The longitudinal seam is of the double-riveted butt-strap type rving an efficiency of 82%. The safety valve is set for 125 pounds ressure. What maximum pressure should be allowed on the boiler?

(b) Referring to Table 9, it shows that the normal efficiency of the tch seam is 57%.

Table 10  
TABLE OF CONSTANTS FOR USE IN COMPUTING PATCH SEAMS WHEN HEADS ARE SUPPORTED

Efficiency of longitudinal seams or diagonal efficiency—E	"e" efficiency of patch seams															
	.50	.51	.52	.53	.54	.55	.56	.57	.58	.59	.60	.61	.62	.63	.64	.65
65	1.68	1.60	1.51	1.43	1.36	1.28	1.20	1.13	1.06	1.00	0.94	0.88	0.82	0.76	0.70	0.65
66	1.72	1.67	1.60	1.53	1.46	1.39	1.32	1.25	1.18	1.12	1.06	1.00	0.94	0.88	0.82	0.76
67	1.82	1.73	1.65	1.57	1.49	1.41	1.33	1.25	1.17	1.10	1.04	0.98	0.92	0.86	0.80	0.74
68	1.88	1.78	1.70	1.62	1.54	1.46	1.38	1.30	1.22	1.14	1.08	1.02	0.96	0.90	0.84	0.78
69	1.94	1.80	1.71	1.63	1.55	1.47	1.39	1.31	1.23	1.15	1.09	1.03	0.97	0.91	0.85	0.79
70	2.01	1.91	1.81	1.73	1.65	1.57	1.49	1.41	1.33	1.25	1.19	1.13	1.07	1.01	0.95	0.89
71	2.07	1.97	1.87	1.79	1.71	1.63	1.55	1.47	1.39	1.31	1.25	1.19	1.13	1.07	1.01	0.95
72	2.12	2.03	1.93	1.85	1.77	1.69	1.61	1.53	1.45	1.37	1.31	1.25	1.19	1.13	1.07	1.01
73	2.17	2.09	1.99	1.91	1.83	1.75	1.67	1.59	1.51	1.43	1.37	1.31	1.25	1.19	1.13	1.07
74	2.23	2.14	2.06	1.98	1.91	1.83	1.75	1.67	1.59	1.51	1.44	1.38	1.32	1.26	1.20	1.14
75	2.28	2.20	2.12	2.04	1.96	1.88	1.81	1.73	1.65	1.57	1.50	1.44	1.38	1.32	1.26	1.20
76	2.33	2.25	2.17	2.09	2.02	1.94	1.86	1.78	1.70	1.62	1.55	1.49	1.43	1.37	1.31	1.25
77	2.38	2.30	2.22	2.14	2.07	2.00	1.92	1.84	1.76	1.68	1.61	1.55	1.49	1.43	1.37	1.31
78	2.44	2.36	2.28	2.20	2.13	2.05	1.97	1.89	1.81	1.73	1.66	1.60	1.54	1.48	1.42	1.36
79	2.50	2.42	2.34	2.26	2.18	2.10	2.03	1.95	1.87	1.79	1.72	1.66	1.60	1.54	1.48	1.42
80	2.55	2.46	2.39	2.30	2.23	2.15	2.08	2.00	1.92	1.84	1.77	1.71	1.65	1.59	1.53	1.47
81	2.60	2.51	2.43	2.36	2.28	2.20	2.13	2.05	1.97	1.89	1.82	1.76	1.70	1.64	1.58	1.52
82	2.65	2.56	2.48	2.40	2.33	2.25	2.18	2.10	2.02	1.94	1.87	1.81	1.75	1.69	1.63	1.57
83	2.69	2.61	2.53	2.45	2.38	2.30	2.22	2.14	2.06	1.98	1.91	1.85	1.79	1.73	1.67	1.61
84	2.70	2.62	2.54	2.46	2.39	2.31	2.23	2.15	2.07	2.00	1.93	1.87	1.81	1.75	1.69	1.63
85	2.75	2.66	2.58	2.50	2.43	2.35	2.27	2.19	2.11	2.03	1.96	1.90	1.84	1.78	1.72	1.66
86	2.80	2.71	2.63	2.55	2.48	2.40	2.32	2.24	2.16	2.08	2.01	1.95	1.89	1.83	1.77	1.71
87	2.85	2.77	2.68	2.60	2.52	2.44	2.36	2.28	2.20	2.12	2.05	1.99	1.93	1.87	1.81	1.75
88	2.90	2.82	2.74	2.65	2.57	2.49	2.41	2.33	2.25	2.17	2.10	2.04	1.98	1.92	1.86	1.80
89	2.95	2.87	2.78	2.70	2.62	2.54	2.46	2.38	2.30	2.22	2.14	2.07	2.01	1.95	1.89	1.83
90	3.01	2.92	2.83	2.75	2.67	2.59	2.51	2.43	2.35	2.27	2.19	2.12	2.06	2.00	1.94	1.88
91		2.97	2.88	2.80	2.72	2.64	2.56	2.48	2.40	2.32	2.24	2.17	2.11	2.05	1.99	1.93
92			2.94	2.86	2.77	2.69	2.61	2.53	2.45	2.37	2.29	2.22	2.16	2.10	2.04	1.98
93			2.90	2.82	2.74	2.66	2.58	2.50	2.42	2.34	2.26	2.19	2.13	2.07	2.01	1.95
94			2.87	2.79	2.71	2.63	2.55	2.47	2.39	2.31	2.23	2.16	2.10	2.04	1.98	1.92
95			2.83	2.75	2.67	2.59	2.51	2.43	2.35	2.27	2.19	2.12	2.06	2.00	1.94	1.88
			2.81	2.73	2.65	2.57	2.49	2.41	2.33	2.25	2.17	2.10	2.04	1.98	1.92	1.86
			2.79	2.71	2.63	2.55	2.47	2.39	2.31	2.23	2.15	2.08	2.02	1.96	1.90	1.84
			2.77	2.69	2.61	2.53	2.45	2.37	2.29	2.21	2.13	2.06	2.00	1.94	1.88	1.82
			2.75	2.67	2.59	2.51	2.43	2.35	2.27	2.19	2.12	2.06	2.00	1.94	1.88	1.82
			2.73	2.65	2.57	2.49	2.41	2.33	2.25	2.17	2.10	2.04	1.98	1.92	1.86	1.80
			2.71	2.63	2.55	2.47	2.39	2.31	2.23	2.15	2.08	2.02	1.96	1.90	1.84	1.78
			2.69	2.61	2.53	2.45	2.37	2.29	2.21	2.13	2.06	2.00	1.94	1.88	1.82	1.76
			2.67	2.59	2.51	2.43	2.35	2.27	2.19	2.11	2.04	1.98	1.92	1.86	1.80	1.74
			2.65	2.57	2.49	2.41	2.33	2.25	2.17	2.09	2.02	1.96	1.90	1.84	1.78	1.72
			2.63	2.55	2.47	2.39	2.31	2.23	2.15	2.07	2.00	1.94	1.88	1.82	1.76	1.70
			2.61	2.53	2.45	2.37	2.29	2.21	2.13	2.05	1.98	1.92	1.86	1.80	1.74	1.68
			2.59	2.51	2.43	2.35	2.27	2.19	2.11	2.03	1.96	1.90	1.84	1.78	1.72	1.66
			2.57	2.49	2.41	2.33	2.25	2.17	2.09	2.01	1.94	1.88	1.82	1.76	1.70	1.64
			2.55	2.47	2.39	2.31	2.23	2.15	2.07	2.00	1.94	1.88	1.82	1.76	1.70	1.64
			2.53	2.45	2.37	2.29	2.21	2.13	2.05	1.97	1.90	1.84	1.78	1.72	1.66	1.60
			2.51	2.43	2.35	2.27	2.19	2.11	2.03	1.95	1.88	1.82	1.76	1.70	1.64	1.58
			2.49	2.41	2.33	2.25	2.17	2.09	2.01	1.93	1.86	1.80	1.74	1.68	1.62	1.56
			2.47	2.39	2.31	2.23	2.15	2.07	1.99	1.91	1.84	1.78	1.72	1.66	1.60	1.54
			2.45	2.37	2.29	2.21	2.13	2.05	1.97	1.89	1.82	1.76	1.70	1.64	1.58	1.52
			2.43	2.35	2.27	2.19	2.11	2.03	1.95	1.87	1.80	1.74	1.68	1.62	1.56	1.50
			2.41	2.33	2.25	2.17	2.09	2.01	1.93	1.85	1.78	1.72	1.66	1.60	1.54	1.48
			2.39	2.31	2.23	2.15	2.07	1.99	1.91	1.83	1.76	1.70	1.64	1.58	1.52	1.46
			2.37	2.29	2.21	2.13	2.05	1.97	1.89	1.81	1.74	1.68	1.62	1.56	1.50	1.44
			2.35	2.27	2.19	2.11	2.03	1.95	1.87	1.79	1.72	1.66	1.60	1.54	1.48	1.42
			2.33	2.25	2.17	2.09	2.01	1.93	1.85	1.77	1.70	1.64	1.58	1.52	1.46	1.40
			2.31	2.23	2.15	2.07	1.99	1.91	1.83	1.75	1.68	1.62	1.56	1.50	1.44	1.38
			2.29	2.21	2.13	2.05	1.97	1.89	1.81	1.73	1.66	1.60	1.54	1.48	1.42	1.36
			2.27	2.19	2.11	2.03	1.95	1.87	1.79	1.71	1.64	1.58	1.52	1.46	1.40	1.34
			2.25	2.17	2.09	2.01	1.93	1.85	1.77	1.69	1.62	1.56	1.50	1.44	1.38	1.32
			2.23	2.15	2.07	1.99	1.91	1.83	1.75	1.67	1.60	1.54	1.48	1.42	1.36	1.30
			2.21	2.13	2.05	1.97	1.89	1.81	1.73	1.65	1.58	1.52	1.46	1.40	1.34	1.28
			2.19	2.11	2.03	1.95	1.87	1.79	1.71	1.63	1.56	1.50	1.44	1.38	1.32	1.26
			2.17	2.09	2.01	1.93	1.85	1.77	1.69	1.61	1.54	1.48	1.42	1.36	1.30	1.24
			2.15	2.07	1.99	1.91	1.83	1.75	1.67	1.59	1.52	1.46	1.40	1.34	1.28	1.22
			2.13	2.05	1.97	1.89	1.81	1.73	1.65	1.57	1.50	1.44	1.38	1.32	1.26	1.20
			2.11	2.03	1.95	1.87	1.79	1.71	1.63	1.55	1.48	1.42	1.36	1.30	1.24	1.18
			2.09	2.01	1.93	1.85	1.77	1.69	1.61	1.53	1.46	1.40	1.34	1.28	1.22	1.16
			2.07	1.99	1.91	1.83	1.75	1.67	1.59	1.51	1.44	1.38	1.32	1.26	1.20	1.14
			2.05	1.97	1.89	1.81	1.73	1.65	1.57							

TABLE OF CONSTANTS FOR USE IN COMPUTING PATCH SEAMS WHEN HEADS ARE UNSUPPORTED

Efficiency of longitudinal seams or diagonal efficiency—E	"e" efficiency of patch seams															
	.50	.51	.52	.53	.54	.55	.56	.57	.58	.59	.60	.61	.62	.63	.64	.65
.65	2.20	2.06	1.93	1.80	1.69	1.56	1.45	1.35	1.24	1.14	1.12	1.10	1.08	1.06	1.04	1.02
.66	2.30	2.16	2.03	1.90	1.78	1.66	1.55	1.45	1.34	1.22	1.21	1.19	1.17	1.15	1.13	1.11
.67	2.40	2.26	2.13	2.00	1.88	1.75	1.64	1.52	1.41	1.32	1.31	1.29	1.27	1.25	1.23	1.21
.68	2.50	2.36	2.23	2.10	1.98	1.86	1.73	1.63	1.52	1.42	1.41	1.39	1.37	1.35	1.33	1.31
.69	2.62	2.46	2.33	2.20	2.07	1.95	1.84	1.71	1.61	1.50	1.49	1.47	1.45	1.43	1.41	1.39
.70	2.75	2.57	2.43	2.30	2.16	2.04	1.93	1.80	1.69	1.59	1.57	1.55	1.53	1.51	1.49	1.47
.71	2.87	2.70	2.55	2.42	2.26	2.14	2.02	1.90	1.79	1.67	1.66	1.64	1.62	1.60	1.58	1.56
.72	3.00	2.81	2.65	2.48	2.36	2.23	2.11	1.99	1.88	1.78	1.75	1.73	1.71	1.69	1.67	1.65
.73	3.14	2.93	2.76	2.60	2.46	2.33	2.20	2.09	1.97	1.87	1.83	1.81	1.79	1.77	1.75	1.73
.74	3.28	3.07	2.87	2.71	2.56	2.42	2.30	2.19	2.06	1.95	1.92	1.89	1.88	1.86	1.84	1.82
.75	3.42	3.19	3.00	2.83	2.68	2.52	2.40	2.27	2.15	2.05	2.01	1.98	1.97	1.95	1.93	1.91
.76	3.52	3.32	3.14	2.96	2.78	2.62	2.49	2.36	2.24	2.12	2.10	2.07	2.06	2.04	2.02	1.99
.77	3.62	3.46	3.30	3.11	2.92	2.74	2.58	2.45	2.32	2.20	2.19	2.16	2.15	2.13	2.11	2.09
.78	3.72	3.58	3.40	3.20	3.03	2.85	2.69	2.55	2.42	2.30	2.29	2.26	2.25	2.23	2.21	2.19
.79	3.82	3.68	3.49	3.28	3.16	2.97	2.80	2.65	2.51	2.39	2.38	2.35	2.34	2.32	2.30	2.28
.80	3.92	3.78	3.59	3.46	3.34	3.15	2.92	2.75	2.61	2.47	2.46	2.43	2.42	2.40	2.38	2.36
.81	4.02	3.88	3.69	3.56	3.40	3.20	3.03	2.87	2.71	2.57	2.56	2.53	2.52	2.50	2.48	2.46
.82	4.12	3.98	3.79	3.66	3.46	3.26	3.09	2.92	2.82	2.67	2.66	2.63	2.62	2.60	2.58	2.56
.83	4.22	4.08	3.89	3.76	3.54	3.34	3.29	3.10	3.05	2.89	2.88	2.85	2.84	2.82	2.80	2.78
.84	4.32	4.18	3.99	3.86	3.62	3.42	3.39	3.22	3.17	2.99	2.98	2.95	2.94	2.92	2.90	2.88
.85	4.42	4.28	4.09	3.96	3.70	3.50	3.47	3.30	3.25	3.07	3.06	3.03	3.02	3.00	2.98	2.96
.86	4.52	4.38	4.19	4.06	3.78	3.58	3.55	3.38	3.33	3.15	3.14	3.11	3.10	3.08	3.06	3.04
.87	4.62	4.48	4.29	4.16	3.86	3.66	3.63	3.46	3.41	3.23	3.22	3.19	3.18	3.16	3.14	3.12
.88	4.72	4.58	4.39	4.26	3.94	3.74	3.71	3.54	3.49	3.31	3.30	3.27	3.26	3.24	3.22	3.20
.89	4.82	4.68	4.49	4.36	4.02	3.82	3.79	3.62	3.57	3.39	3.38	3.35	3.34	3.32	3.30	3.28
.90	4.92	4.78	4.59	4.46	4.10	3.90	3.87	3.70	3.65	3.47	3.46	3.43	3.42	3.40	3.38	3.36
.91	5.02	4.88	4.69	4.56	4.18	3.98	3.95	3.78	3.73	3.55	3.54	3.51	3.50	3.48	3.46	3.44
.92	5.12	4.98	4.79	4.66	4.26	4.06	4.03	3.86	3.81	3.63	3.62	3.59	3.58	3.56	3.54	3.52
.93	5.22	5.08	4.89	4.76	4.34	4.14	4.11	3.94	3.89	3.71	3.70	3.67	3.66	3.64	3.62	3.60
.94	5.32	5.18	4.99	4.86	4.42	4.22	4.19	4.02	3.97	3.79	3.78	3.75	3.74	3.72	3.70	3.68
.95	5.42	5.28	5.09	4.96	4.50	4.30	4.27	4.10	4.05	3.87	3.86	3.83	3.82	3.80	3.78	3.76

Constant "C" Triangle or crescent shape patches  $C = W + L$   
 Diamond or oval shape patches  $C = 2W + L$   
 History: Cr. Register, December, 1956, No. 12, eff. 1-1-57.

(c) If the efficiency is not found in the table, refer to any other available table or determine it in the customary manner described in sections Ind 41.50 and Ind 41.51 of this code.

(d) Divide the width of the patch  $W = 48$  inches by the length  $L = 30$  inches to find the constant  $C = 48/30 = 1.60$ .

(e) Follow down column  $e = 0.57$  of Table 10 until 1.60 is found. It will be noted that this is somewhere between 1.56 and 1.62 representing  $E$  somewhere between 0.72 and 0.73. As the difference between 1.56 and 1.62 is 6, and the difference between 1.56 and 1.60 is 4,  $E$  will be 0.72 plus 4/6 of 0.001 which is 0.7266.

(f) The pressure approved varies directly as the seam efficiency. Accordingly  $P = 0.7266/0.82 \times 125 = 110$  pounds per square inch.

(g) If this allowance interferes with the operation of the plant, the patch will have to be replaced by a new one with proper dimensions giving a diagonal efficiency of 82%.

(3) DESIGN OF PATCH FOR WATER-TUBE BOILER. (a) Sections of the plate having a total length of 36 inches (measured at the pitch line) are to be removed on each side of a girth seam. The patch is to be diamond or oval shape. The shell plate is 7/16 inches thick and the longitudinal seam is double-riveted butt strap construction, having an efficiency of 82%. What should be the width of the patch for maintaining the same pressure allowance?

(b) Referring to Table 9, it shows that a single-riveted lap seam with 7/16 inch plate, 15/16 inch diameter rivet holes, and 2 1/2 inch pitch has a normal efficiency of 56%.

(c) Referring to Table 11, it shows for  $E = 0.82$  and  $e = 0.56$ , the constant  $C$  is 3.16.

(d) Then width  $W = C \times L \div 2$   
 $W = 3.16 \times 36 \div 2 = 56.88$ , say 57 inches.

History: Cr. Register, December, 1956, No. 12, eff. 1-1-57.

Ind 42.59 Welding procedure. Manufacturers, owners or contractors undertaking repairs under these rules shall have available for the inspector a written welding procedure specification that shall be followed in making the necessary repair and also a record of procedure qualification tests. Welding procedure specifications shall have been prepared and qualified in accordance with the requirements of sections Ind 41.50 and Ind 41.51 of this code under Welding Qualifications, section Ind 41.50-(6). Repairs by fusion welding on low pressure steam and hot water boilers shall be exempt from the provisions of sections Ind 42.50 through Ind 42.79, except that a qualified welder shall be required for such repairs and the repairs shall conform to sections Ind 42.61, Ind 42.62, Ind 42.63, Ind 42.64, and Ind 42.78.

History: Cr. Register, December, 1956, No. 12, eff. 1-1-57.

Ind 42.60 Welders. (1) WELDER QUALIFICATION. Manufacturers, owners or contractors shall have available for the inspector records of welder qualification tests showing that each welder to be employed on the work has satisfactorily passed tests as prescribed in sections Ind 41.50 and Ind 41.51 of this code under Welding Qualifications for the type of filler metal to be used and for each position in which he will be called upon to operate in making the repair.

(2) WELDING TESTS, MANUFACTURER'S, OWNER'S OR CONTRACTOR'S RESPONSIBILITY, INSPECTOR'S DUTY. Preparation of welding procedure

specifications and the conducting of tests of procedures and welders shall be the responsibility of the manufacturer, owners or contractor. Before repairs are started, it shall be the duty of the inspector to satisfy himself by examination of the written welding procedure and records of qualification tests that procedures and welders have been properly qualified as required in section Ind 41.50 (6). Witnessing of the tests by the inspector shall not be mandatory but he shall have the right to witness such tests when he deems it necessary. The inspector shall also have the right to call for and witness the making of test plates by any welder, at any time, and to observe the physical testing of such plates.

**History:** Cr. Register, December, 1956, No. 12, eff. 1-1-57.

**Ind 42.61 Rules for welding.** The repairs that may be made under these rules are limited to steels of flange or fire box quality having known weldable quality and further limited to carbon steels having carbon content of not more than 0.35% and low alloy steels having carbon content of not more than 0.25%. Structural steel shall not be used. The welding of high alloy material and non-ferrous material shall be done in accordance with the requirements of sections Ind 1.50 and Ind 41.51 of this code for boilers and unfired pressure vessels.

**History:** Cr. Register, December, 1956, No. 12, eff. 1-1-57.

**Ind 42.62 Prohibited repairs.** A welder shall not make repairs in plate thickness in excess of that permitted under sections Ind 41.50 and Ind 41.51 of this code for Welding Qualifications. A welder shall not make repairs on a material that is not covered within his qualification tests.

**History:** Cr. Register, December, 1956, No. 12, eff. 1-1-57.

**Ind 42.63 Procedure.** Groove welds shall completely penetrate the thickness of the material being welded. If possible, welding shall be applied from both sides of the plate or a backing strip or ring may be used to insure complete penetration. Manually applied welds shall have a convex surface on both sides if applied on both sides of the plates being joined, or on one side if welding is applied from one side only. Valleys and undercutting at edges of welded joints shall not be permitted. The reinforcement may be chipped, ground, or machined off flush with the base metal, if so desired, after the welding has been completed.

**History:** Cr. Register, December, 1956, No. 12, eff. 1-1-57.

**Ind 42.64 Defective weld.** In making a repair to a weld that has failed in service, the defective weld shall be removed by chipping, grinding or gouging until sound metal is reached on all sides. The resulting groove shall be filled as required by the applicable welding procedure.

**History:** Cr. Register, December, 1956, No. 12, eff. 1-1-57.

**Ind 42.65 Stress relieving operations.** (1) In repairing carbon or low alloy steels, when required by these rules and considered necessary by the authorized inspector, thermal stress relieving shall be applied to the completed work. The heat may be applied by any means that will raise the temperature of the material being heated gradually

and uniformly to approximately 1,200 degrees Fahrenheit. (In the absence of more accurate means of determining temperature, a dull red glow in daylight will suffice). This temperature shall be maintained for a period of one hour per inch of thickness of material. For circumferential joints, the area heated shall comprise a band extending completely around the cylinder and having a width on each side of the center line of the weld not less than 3 times the greatest width of the finished weld. For nozzles, the heated area shall comprise a circumferential band extending around the entire vessel, including the nozzle or welded attachment and shall extend at least 6 times the plate thickness beyond the welding which connects the nozzle or other attachment to the vessel. Under certain conditions other methods of thermal stress relieving acceptable to the authorized inspector may be used. Under certain conditions preheating may be necessary.

(2) Upon completion of the stress relieving operation, the plate shall be allowed to cool at a rate not greater than 500 degrees Fahrenheit per hour divided by the maximum thickness of the welded part in inches, but in no case more than 500 degrees Fahrenheit per hour. This rate of cooling shall be maintained until a temperature of approximately 600 degrees Fahrenheit is reached, after which normal cooling by exposure in a still atmosphere may be permitted.

(3) Thermal stress relieving of austenitic steels is a controversial subject. It shall not be attempted except in accordance with the recommendations of the manufacturer of the material or the requirements of sections Ind 41.50 and Ind 41.51 of this code.

(4) In lieu of thermal stress relieving of carbon steels, peening or other methods acceptable to the authorized inspector may be employed.

**History:** Cr. Register, December, 1956, No. 12, eff. 1-1-57.

**Ind 42.66 Cracks, permissible welded repairs.** (1) Cracks in unstayed shells, drums or headers of boilers or pressure vessels may be repaired by welding, providing the cracks do not extend between rivet holes in a longitudinal seam or parallel to a rivet seam within 8 inches, measured from nearest calking edge. The total length of any one such crack shall not exceed 8 inches. Cracks of a greater length may be welded, provided the complete repair is radiographed and stress relieved in accordance with section Ind 42.65. See Figures 8 and 8 (a) for Acceptable Methods.

(2) Cracks of any length in unstayed furnaces may be welded, provided the welds are thermally stress relieved in accordance with section Ind 42.65. Welds applied from both sides of the plate shall be used where possible. Welds applied from one side only shall be subject to the approval of the authorized inspector. Field repair of cracks at knuckle or turn of flange of furnace opening are prohibited unless specifically approved by the industrial commission. See Figure 9 for Acceptable Methods.

(3) Cracks of any length in stayed areas may be repaired by fusion welding except that multiple or star cracks radiating from rivet or staybolt holes shall not be welded. See Figure 10 for Acceptable Methods.

**History:** Cr. Register, December, 1956, No. 12, eff. 1-1-57.

**Ind 42.69 Corroded surfaces and seal welding.** (1) Corroded areas on stayed surfaces may be built up by fusion welding, provided the remaining plate has an average thickness of not less than 50% of the original thickness, and further provided that the areas so affected are not sufficiently extensive to impair the safety of the object. See Figure 11 for Acceptable Methods.

(2) Corroded areas around manhole or handhole openings in either stayed or unstayed plates may be built up by fusion welding, provided the average loss of thickness does not exceed 50% of the original plate thickness and also provided the area to be so repaired does not extend more than 3 inches from the edge of the hole.

(3) Corroded areas in unstayed shells, drums or headers may be built up by fusion welding provided that in the judgment of the authorized inspector, the strength of the structure has not been impaired. See Figure 12 for Acceptable Methods.

(4) Edges of butt straps or of plate laps and nozzles or connections attached by riveting may be restored to original dimensions by welding. Seal welding shall not be used except with the special approval of the authorized inspector, and in no case where cracks are present in riveted areas. See Figure 13 for Acceptable Methods.

(5) The ends of tubes in fire tube and water tube boilers may be all welded provided they have not been reduced more than 10% thickness, and requirements of sections Ind 41.50 and Ind 41.51 of this code are satisfied. See Figure 14 for Acceptable Methods.

**History:** Cr. Register, December, 1956, No. 12, eff. 1-1-57.

**Ind 42.74 Re-ending and piecing tubes.** Re-ending or piecing of tubes or pipes in either fire tube or water tube boilers is permitted provided the thickness of the tube or pipe has not been reduced by more than 10% from that required by sections Ind 41.50 and Ind 41.51 of this code for the pressure to be carried. In all cases the requirements of sections Ind 41.50 and Ind 41.51 of this code shall be met.

**History:** Cr. Register, December, 1956, No. 12, eff. 1-1-57.

**Ind 42.75 Patches, material.** The material used for patches shall be of the same general quality and have at least the minimum physical properties of the plate to be patched. The thickness of any patch shall be at least equal to, but not more than,  $\frac{1}{8}$  inch greater than the plate being patched.

**History:** Cr. Register, December, 1956, No. 12, eff. 1-1-57.

**Ind 42.76 Flush or butt welded patches.** (1) Flush or butt welded patches in unstayed shells, drums or headers shall be radiographed and stress relieved to conform to the requirements of sections Ind 41.50 and Ind 41.51 of this code for new construction. Subject to the approval of an authorized inspector, peening or other methods of stress relieving may be substituted for thermal stress relieving. Subject to compliance with this requirement, no limit is placed on dimensions or location of such patches or on the thickness of the material. When the longest dimension of a patch does not exceed 8 times the plate thickness or a maximum of 8 inches, radiographing and stress relieving is not required. See Figure 15 for Acceptable Methods.

Boiler and Unfired Pressure Vessel Code Register, December, 1956, No. 12

(2) Flush or butt welded patches or new sections may be applied to stayed plates without limitation of size or plate thickness. See Figure 16 for Acceptable Methods.

**History:** Cr. Register, December, 1956, No. 12, eff. 1-1-57.

**Ind 42.78 Lapped and fillet welded patches.** Lapped and fillet welded patches may be applied to stayed plates provided they are not exposed to radiant heat. Lapped and fillet welded patches may be applied on the pressure side of the sheet in unstayed areas, provided the maximum diameter of the opening so repaired does not exceed 16 times the thickness of the plate, but in no case larger than 8 inches in diameter. See Figure 17 for Acceptable Methods.

**History:** Cr. Register, December, 1956, No. 12, eff. 1-1-57.

**Ind 42.79 Stays.** (1) Threaded stays may be replaced by welded-in stays provided that in the judgment of the inspector the plate adjacent to the stay bolt has not been materially weakened by deterioration or wasting away. All requirements of the applicable section of sections Ind 41.50 and Ind 41.51 of this code governing welded-in stays shall be met, except that stress relieving other than thermal may be used as provided in section Ind 42.65.

**History:** Cr. Register, December, 1956, No. 12, eff. 1-1-57.

**Ind 42.80 Additional acceptable repair methods.** Repairs and repair methods not discussed in the chapter shall comply with methods illustrated in Figures 18, 19, 20, and 21.

**History:** Cr. Register, December, 1956, No. 12, eff. 1-1-57.

Boiler and Unfired Pressure Vessel Code Register, December, 1956, No. 12

Fig. 8

Fig. 8a

CRACKS IN UNSTAYED SHELLS, DRUMS AND HEADERS

Circumferential Cracks at Girth Seams

**Caution:** Before attempting repairs care shall be taken to investigate the cause of cracks of this type. Welding shall not be used if "caustic embrittlement" is indicated. Multiple or star cracks shall not be welded.

If repair by welding is authorized, method for repairing fire cracks at girth seams shall be used.

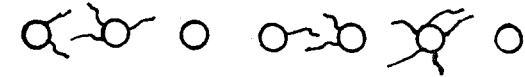

Example of Multiple or Star Cracking

Cracks Between Tube Holes

In repairing cracks of this type, welding shall be applied from both sides of the plate if possible.

The tubes to which the cracks extend and the tubes on each side of them shall be removed and the cracks chipped, ground or gouged to provide the required welding groove. Tube holes shall be reamed before new tubes are installed.

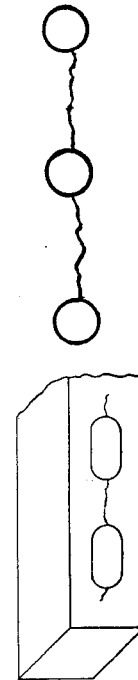

Cracks in Headers

In repairing cracks of this type, welding may be applied from one side. A backing strip shall be used if possible to insure complete penetration at bottom of welding groove.

CRACKS IN UNSTAYED SHELLS, DRUMS AND HEADERS

Fire Cracks at Girth Seams

Prior to repairing fire cracks by welding, the rivets to which such cracks may extend and the rivets on each side of them shall be removed.

Tack bolts shall be placed in alternate holes to hold the plate laps firmly.

Cracks shall then be chipped, ground or gouged to produce required welding groove.

CRACKS WHICH EXTEND PAST THE INNER EDGE OF THE PLATE LAP SHALL BE WELDED FROM BOTH SIDES.

Rivet holes shall be reamed before new rivets are driven.

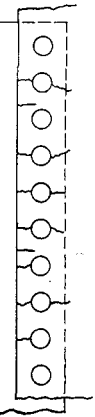

Fire Cracks at Door Openings

Repairs shall be made as for fire cracks at girth seams. Patch bolts may be used where it is not possible to redrive rivets.

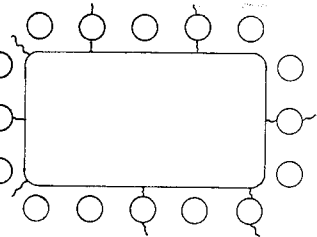

Patch Bolt

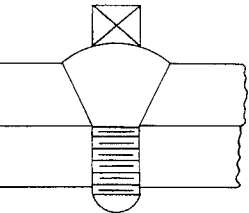
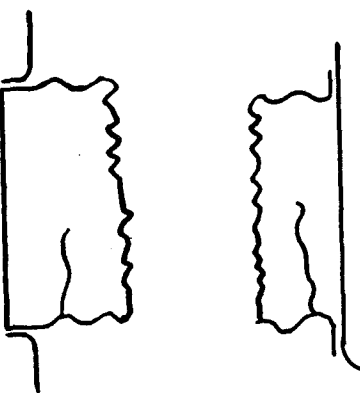

Fig. 9

CRACKS IN UNSTAYED FURNACES



**Caution:** Successful performance of this repair requires a ductile weld free from slag inclusions, voids, cracks or other defects.

Cracks shall be chipped, ground or gouged to provide required welding groove; root of weld shall be cleaned by chipping or flame gouging and welding applied from both sides of the plate. Thermal stress relieving is recommended.

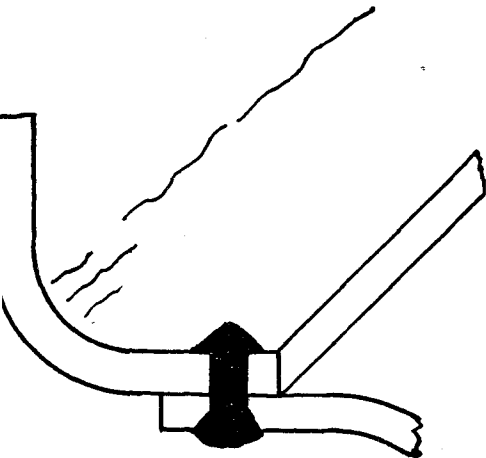

Field repair of cracks at knuckle or turn of flange of furnace opening is difficult. It is recommended that this repair be made in a well equipped shop.

Fig 10

CRACKS IN STAYED PLATES

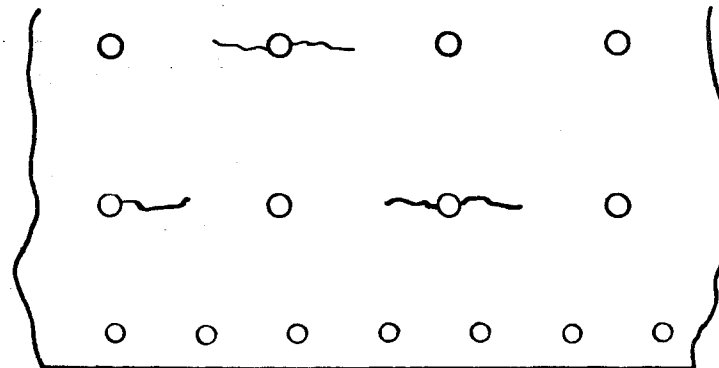

**Caution:** Before attempting repairs to cracks of this type the inner surface of the plate shall be carefully examined for possible excessive corrosion or grooving.

Staybolts to which cracks may extend shall be removed and the cracks then chipped, ground or gouged to provide the required welding groove.

After welding, threaded staybolt holes shall be retapped and new staybolts properly driven and headed.

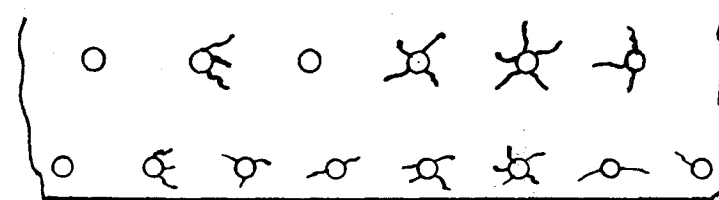

Multiple or star cracks radiating from staybolts or rivet holes shall not be repaired by welding.

Fig. 11

REINFORCING OF CORRODED AREAS IN STAYED PLATES

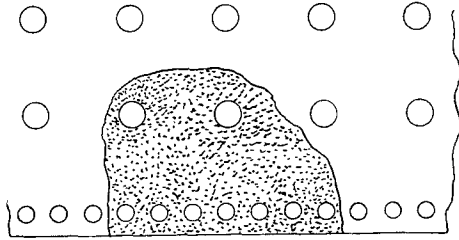

If corroded area includes rivets or staybolts, these shall be removed before welding is applied.

Threaded staybolt holes shall be retapped and rivet holes reamed before new staybolts are installed or rivets are driven.

Note: Welding shall not cover rivets or staybolt heads.

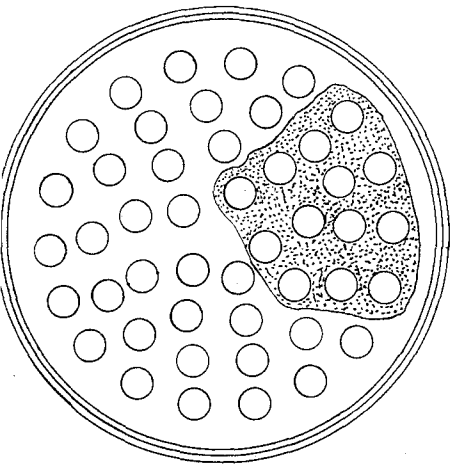

Corroded areas of tube sheets may be built up by welding where tubes act as stays.

All tubes in such corroded areas shall be removed before welding is applied.

After welding the tube holes shall be reamed before new tubes are installed.

Fig. 12

CORRODED AREAS

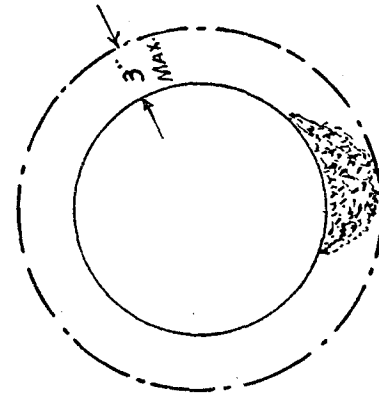

Corroded Area around manhole or handhole openings.

Corroded area shall be thoroughly cleaned before welding.

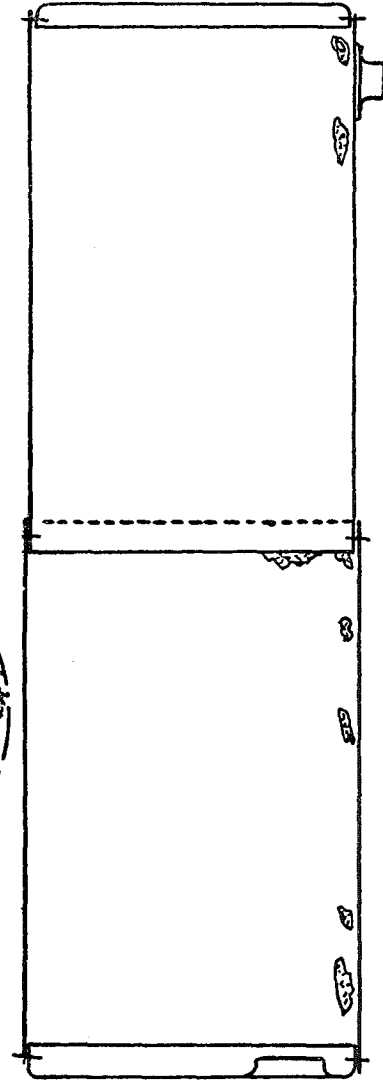

No corroded area which is shown in this sketch and which exceeds in size the permissible area of an unreinforced opening or exceeding in average depth 50% of the plate required thickness shall be "built up" by welding. Larger areas in vessels which are subject to internal corrosion or erosion but where the required thickness would be satisfactory for the pressure, can be built up under this rule.





Fig 13

SEAL WELDING OF CAULKING EDGES

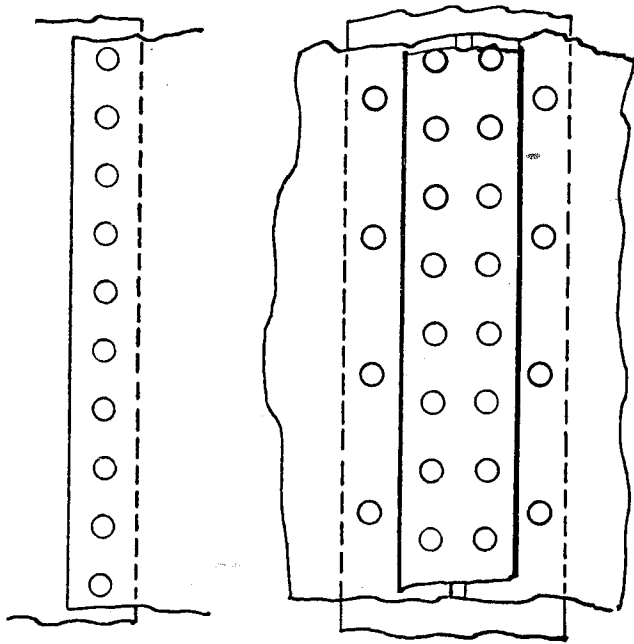

**Caution.**—Seal welding shall not be applied if cracks are present in riveted areas.  
 Indications of persistent or recurring leakage may be a sign of racking. No welding shall be applied until a careful examination—including removal of rivets if necessary—has been made of such areas.  
 Seal welding shall be applied in one light layer if practicable but not more than two layers shall be used.

Throat approx. 1/4"

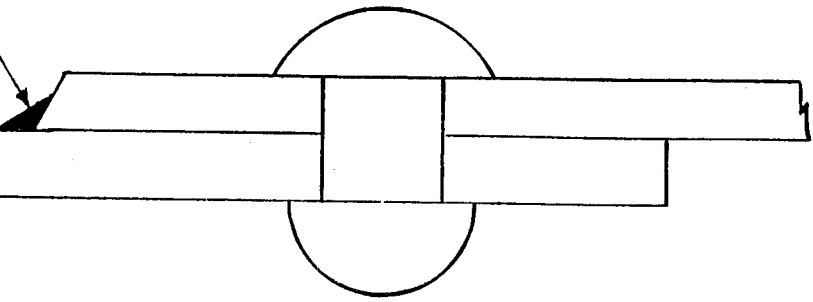
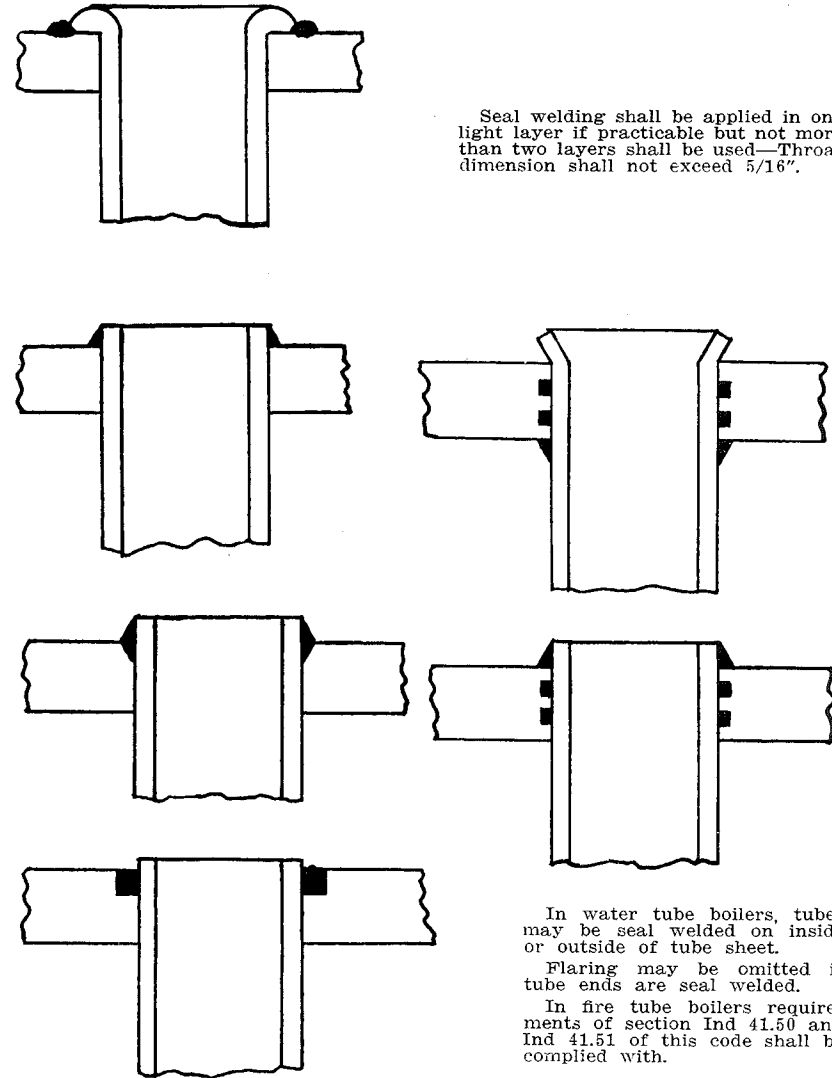

Fig 14

SEAL WELDING OF TUBE ENDS



Seal welding shall be applied in one light layer if practicable but not more than two layers shall be used—Throat dimension shall not exceed 5/16".

In water tube boilers, tubes may be seal welded on inside or outside of tube sheet.

Flaring may be omitted if tube ends are seal welded.

In fire tube boilers requirements of section Ind 41.50 and Ind 41.51 of this code shall be complied with.

Fig 15

FLUSH OR BUTT WELDED PATCHES IN UNSTAYED AREAS

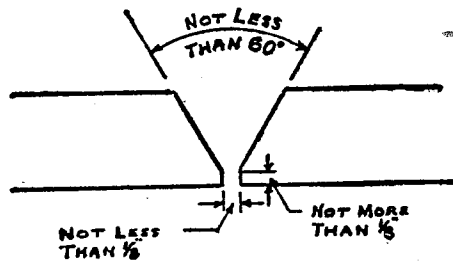

Accepted Detail of Weld

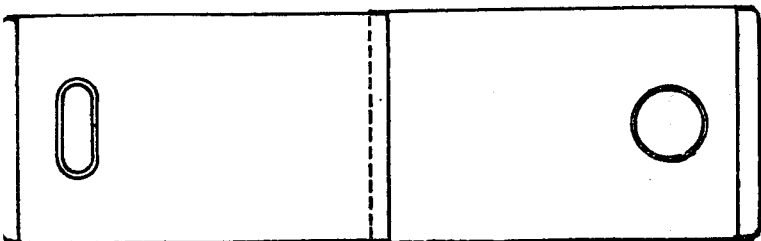

Before any effort is made to patch a bagged or deformed area the original shape or curvature shall be restored as far as possible. Patch shall be rolled or pressed to proper shape or curvature. Edges shall align without overlap.

Flush or butt welded patches may be of any shape, an adequate radius shall however be provided at corners if patch is rectangular. Sharp corners shall be avoided.

*Note:* Patches shall be of material equal to the original construction in thickness and quality.

Fig. 16

FLUSH OR BUTT WELDED PATCHES IN STAYED AREAS

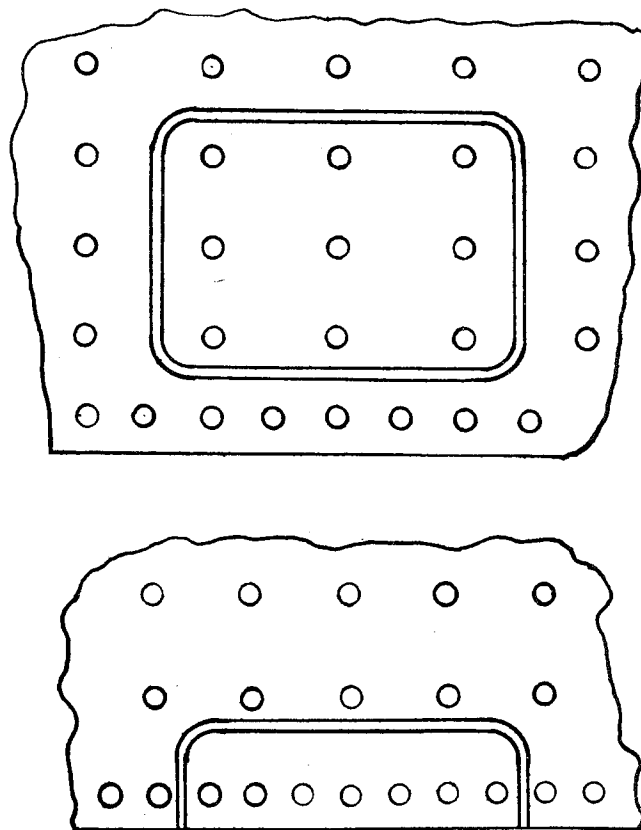

Patches shall be of material equal to the original in quality and thickness. Before applying patches of this type, defective metal shall be cut away until sound material is reached. Patch seams shall come between staybolt rows or riveted seams. In applying patches of this type, square corners shall be avoided. Ample radius shall be provided at corners.

Fig. 17

## LAP-FILLET WELDED PATCHES

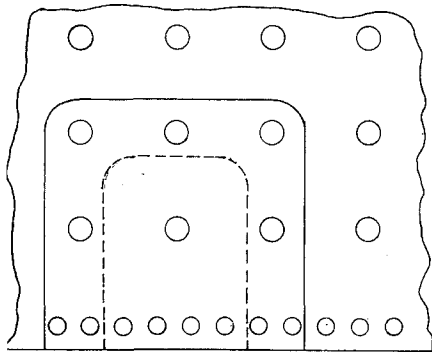

Patches shall be of material equal to the original in quality and thickness.

If area to be patched includes a riveted seam rivets shall be removed before patch is applied and new rivets driven before patch is welded at edges.

New staybolts shall be installed in patched area, the heads of staybolts shall not be covered by welding.

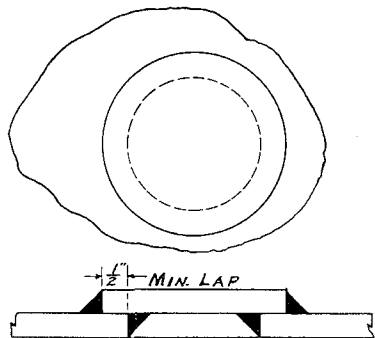

Lap Fillet Welded Patch in Unstayed Area

Fig. 18

## ACCEPTABLE REPAIRS FOR CORRODED OR WORN HEADS OF VERTICAL TUBE OR SIMILAR TYPE BOILERS

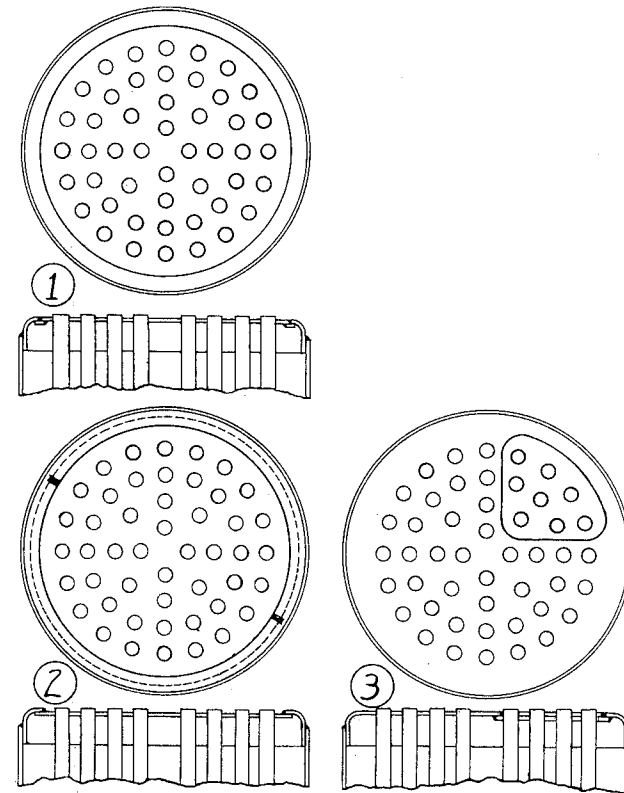

## 1. Flush Butt Welded Head

With this repair the old head is cut close to the point of tangency of the knuckle of the flange and the new head, previously drilled for tube holes and beveled for adequate welding groove is butt welded to flanged section of old head. Pack up ring, inserted in sections if necessary, shall be used to insure weld penetration for full head thickness.

## 2. Lapped and Fillet Welded Head

With this repair, the new head is lapped under the flange knuckle of old head, previously slotted as shown to admit new head, then fillet welded at edge.

## 3. Segmental or Pie-Shaped Butt Welded Patch

Fig. 19

ACCEPTED REPAIRS FOR INSPECTION OPENINGS

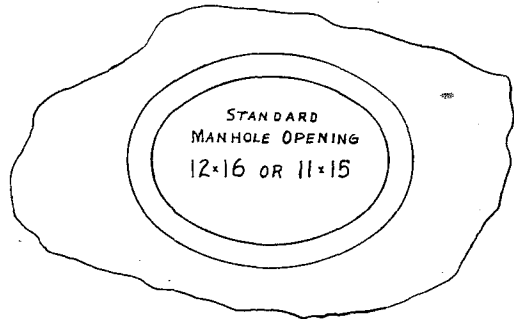

A badly corroded manhole flange may be repaired by cutting out langed section and inserting a ring type frame as shown. Dimensions shall comply with requirements of sections Ind 41.50 and Ind 41.51 of this code.



Ring type frame may be fabricated and stress relieved in shop then welded in place.

Rules for flush patches shall be complied with.

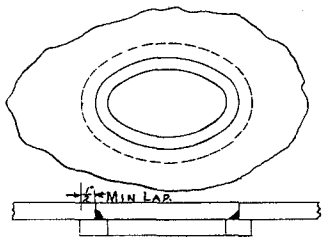
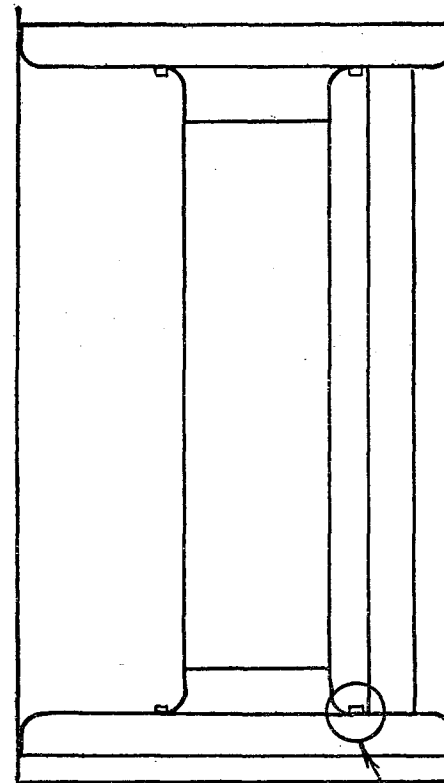

Plate lap should not be less than 1/2".

When corrosion has reduced thickness of plate around handhole opening by more than 50% (average) a reinforcing ring shall be used as shown placed on the inside.

Fig. 20

SUGGESTED METHOD OF INSTALLING NEW FURNACE IN INTERNALLY FIRED BOILER WHERE TUBES ACT AS STAYS SUPPORTING HEADS



With this repair the new furnace shall have special flanges so that weld attaching furnace to heads may be located centrally between edge of tube holes and point of tangency of flange knuckle.

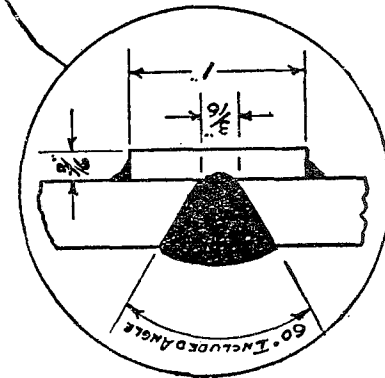
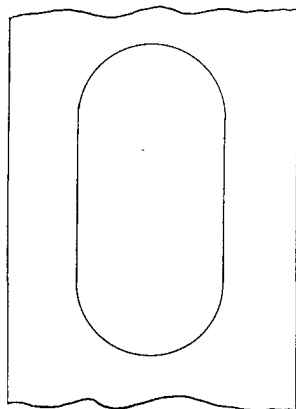
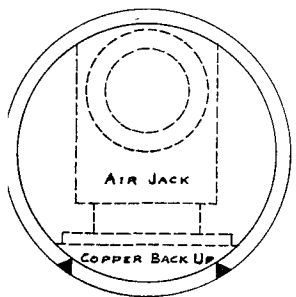

Fig. 21

ACCEPTED "WINDOW" PATCH FOR WATER TUBE  
BOILER TUBES

This type of patch may be used if necessary to seal a hole cut in a water wall tube to provide access for welding the back side of a circum. joint or to replace a small sharp bag.

Window patches shall comply with provisions of sections Ind 41.50 and Ind 41.51 of this code. Patch shall be cut from tube of same size and thickness as the one being repaired.



When practicable, a removable copper backup recessed as shown to provide complete weld penetration through the tube wall and held in place by a removable air jack shall be used during the welding operation.

## BOILER AND UNFIRED PRESSURE VESSEL CODE

## INDEX

Additions or Alterations .....	Ind 42.25	
Advisory Board of Boiler Rules .....	Ind 41.001	
Annual Inspections .....	(See Inspections)	
Automatically Fired Boilers .....	Ind 42.38	
Boilers		
Agricultural Purposes .....	Ind 41.03	
Blow-down Equipment .....	Ind 41.11	
Cast Iron .....	Ind 42.16	
Fire Engines .....	Ind 41.03	
Hot Water .....	Ind 41.02	
Low Pressure Heating .....	Ind 41.001	
Miniature .....	Ind 41.001	Ind 41.50
Non-Standard .....	Ind 41.001	
Portable .....	Ind 41.001	
Power .....	Ind 41.001	Ind 41.50
Secondhand .....	Ind 41.001	
Setting and Installation .....	Ind 42.35	
Special Type .....	Ind 41.10	
Wisconsin Special .....	Ind 41.001	Ind 41.50
Certificate of Competency		
Boiler Inspectors .....	Ind 41.08	
Cocks (See Valves, Gage Cocks, Blow-off Cocks)		
Construction		
Boilers and Unfired Pressure Vessels ..	Ind 41.50	Ind 41.51
	Ind 42.01	
Data, Reports .....	Ind 41.09	
Definitions (Used in Chapters 41 and 42) ..	Ind 41.001	
Domes .....	Ind 42.17	
Door (Access and Firing) .....	Ind 42.37	
Door (Latches) .....	Ind 42.37	
Efficiency of Ligaments .....	Ind 42.14	Ind 42.15
Efficiency of Joint Riveted .....	Ind 42.13	
Efficiency of Joint Welded .....	Ind 42.13	and Table 3
Exemptions .....	Ind 41.06	
Existing Installations, Boiler & Pressure Vessels .....	Ind 42.001	
Factor of Safety—New Installations .....	Ind 41.50	Ind 41.51
Existing Installations .....	Ind 42.09	
Secondhand Boilers & Unfired Pressure Vessels .....	Ind 42.08	
Feed Appliances—Power Boilers .....	Ind 42.18	
Low Pressure Boilers .....	Ind 42.18	
Fittings and Appliances—Power Boilers ..	Ind 42.17	to Ind 42.40
Low Pressure Boilers .....	Ind 42.17	to Ind 42.40
Unfired Pressure Vessels .....	Ind 42.24	Ind 42.25
	Ind 42.27	Ind 42.31
Floorline—Wet Bottom Boilers .....	Ind 42.35	
Furnace—Height .....	Ind 42.53	
Formula Maximum Allowable Working Pres- sure		
On Shells .....	Ind 42.02	
Flat Heads or Surfaces .....	Ind 42.03	
Dished Heads .....	Ind 42.04	
Furnaces and Circular Flues .....	Ind 41.50	Ind 41.51

ages—Pressure		
Heating Boilers	Ind 42.24	
Hot Water Boilers	Ind 42.24	
Power Boilers	Ind 42.24	
Unfired Pressure Vessels	Ind 42.24	
age Cocks (See Valves, Gage Cocks, Etc.)		
Gravity Returns	Ind 42.28	
and Holes		
Heating Boilers	Ind 42.31	
Power Boilers	Ind 42.31	
Unfired Pressure Vessels	Ind 42.31	
Vertical Boilers	Ind 42.31	
anger—To Support	Ind 42.35	
aters—Fuel Oil	Ind 42.28	
ot Water Boilers		
Heating	Ind 41.001	
Water Supply	Ind 41.001	
ydrostatic Test		
New Boilers	Ind 41.50	Ind 41.51
Repaired Boilers	Ind 42.51	
Repaired Unfired Pressure Vessels	Ind 42.51	
Secondhand Boilers	Ind 42.08	
nspection	Ind 41.02	
nspection Certificates	Ind 41.07	
By Cities	Ind 41.05	
External	Ind 41.001	Ind 41.02
Insurance Companies	Ind 41.04	
Internal	Ind 41.001	Ind 41.02
New Boilers	Ind 41.50	Ind 41.51
New Unfired Pressure Vessels	Ind 41.50	Ind 41.51
Non-Periodic	Ind 41.03	
At Shop Repairs	Ind 42.50	
Secondhand Boilers	Ind 42.001	Ind 42.08
Secondhand Unfired Pressure Vessels	Ind 42.001	Ind 42.08
oint Efficiency		
Riveted	Ind 42.13	Ind 41.50
Welded	Ind 42.13	Ind 41.50
ap Seams	Ind 41.50	Ind 41.51
	Ind 42.08	
atches—Door	Ind 42.37	
igaments Between Tube Holes	Ind 42.14	Ind 42.15
ocation of		
Blow-off or Drain	Ind 41.50	Ind 42.27
Drain Between Stop Valves	Ind 42.25	
Feed Piping	Ind 42.28	
Feed Pipe Valves	Ind 42.28	
Gage Cocks	Ind 42.22	
Hand Holes (See Boiler and Unfired Pressure Vessel Openings)	Ind 42.31	
Loop Equalizing Heating Boilers	Ind 42.28	
Lugs and Hangers	Ind 42.35	
Man Holes (See Boilers and Unfired Pressure Vessel Openings)	Ind 42.31	
Relief Valves	Ind 42.17	Ind 42.19
	Ind 41.39	
Safety Valves	Ind 42.17	Ind 42.37
Steam or Pressure Gages	Ind 42.24	
Stop Valves	Ind 42.24	
Water Column Connections	Ind 42.32	
Water Glass	Ind 42.23	
aintenance	Ind 42.33	

Main Stop Valves	Ind 42.25	
Man Holes	Ind 42.31	
Manufacturers' Stamps	Ind 41.50	Ind 41.51
	Ind 42.01	
Miniature Boilers	Ind 41.001	Ind 41.50
Minimum Plate Thickness	Ind 42.07	
Method of Equalizing (Heating Boiler)	Ind 42.28	
Material Strength	Ind 42.10	
Material for Repairs	Ind 42.75	
Maximum Working Pressure, Drums & Shell	Ind 41.50	Ind 41.51
	Ind 42.02	Ind 42.03
	Ind 42.04	
Maximum Pressure Cast Iron Boilers	Ind 42.16	
Numbering of Boilers and Unfired Pressure Vessels	Ind 41.09	Ind 41.50
	Ind 41.51	
Nozzles	Ind 42.30	
Outside Screw and Yoke Type Valves	Ind 42.23	
Patches	Ind 42.52	Ind 42.53
	Ind 42.54	
Petition for Hearing		
Piping		
Blow-off	Ind 42.27	
Feed	Ind 42.28	
Steam Mains	Ind 42.26	
Threads—Minimum Number	Ind 42.34	
Plates—Boiler & Unfired Pressure Vessels		
Strength of	Ind 42.10	
Minimum Thickness	Ind 42.07	
Portable Boilers	Ind 41.001	
Power Boiler	Ind 41.001	Ind 41.50
Preparing Boiler for Inspection	Ind 41.02	
Pressure Allowed		
Blow-down Equipment	Ind 41.11	
Boilers—Power	Ind 41.50	Ind 41.51
	Ind 42.005	
Boiler—Heating	Ind 41.001	
Boiler—Cast Iron	Ind 42.16	
Boiler—Hot Water	Ind 41.001	
Unfired Pressure Vessel	Ind 41.50	Ind 41.51
	Ind 42.005	
Pressure Calculations—Furnaces & Circular Flues	Ind 42.06	
Repairs		
Boiler	Ind 42.50	
Boiler Cracks	Ind 42.66	
Corroded Surfaces	Ind 42.69	
Re-ending and Piecing of Tubes	Ind 42.74	
Unfired Pressure Vessels	Ind 42.50	
Relief Valves	Ind 42.17	Ind 42.19
	Ind 42.40	
Calculations for	Ind 42.40	
Rivets		
Shearing Strength	Ind 42.11	
Dimensions After Driving	Ind 42.12	
For Repairs	Ind 42.54	
Safety Valves		
Connected Boilers	Ind 42.18	
Connected Boilers of Different Pressure	Ind 42.18	
Discharge Pipe	Ind 42.18	
Heating Boilers	Ind 42.18	
Miniature Boilers	Ind 42.18	

Power Boilers -----	Ind 42.18	
Superheater -----	Ind 42.18	
Type Not Permitted -----	Ind 42.18	
Secondhand Boilers -----	Ind 41.001	Ind 42.08
Setting for Boiler -----	Ind 42.35	
Seaming of Rivets -----	Ind 42.11	
Steam Gages -----	Ind 42.24	
Steel Plate Tensile Strength -----	Ind 42.10	
Stamps -----	Ind 41.09	Ind 41.50
	Ind 41.51	
Stop Valves (See Valves)		
Superheater -----	Ind 42.18	
Tables		
Rivet Dimensions After Driving -----	Ind 42.12	
Maximum Efficiencies for Welded Joints	Table 3	
Maximum Pounds of Steam Per Hour per Square Foot of Surface -----	Table 4	
Maximum Number of Pipe Threads for Connections -----	Table 5	
Maximum Air Supplied in Cubic Feet per Minute -----	Table 6	
Orifices Relieving Capacities -----	Table 7	
Internal Pipe Area -----	Table 8	
Efficiencies of Single Riveted Lap Seams	Table 9	
Constants for Use in Computing Patch Seams -----	Table 10	
Temperature Combustion Regulator -----	Ind 42.29	
Tensile Strength of Material -----	Ind 42.10	
Tests—Hydrostatic Pressures -----	Ind 42.08	Ind 41.50
Thermometer for Hot Water Boilers -----	Ind 42.20	
Thickness—Steel Plate -----	Ind 42.07	
Threaded Openings -----	Ind 42.34	
Threads—Number of -----	Table 5	
Valves		
Safety Valves (See Safety Valves)		
Blow-off -----	Ind 42.27	
Discharge Outlets -----	Ind 42.25	
Feed Piping -----	Ind 42.28	
Heating Boilers -----	Ind 42.25	
Superheater -----	Ind 42.18	
Pressure Gages -----	Ind 42.24	
Water Column -----	Ind 42.23	
Water Relief -----	Ind 42.19	Ind 42.39
Washout Openings -----	Ind 42.31	
Water Column & Connections -----	Ind 42.23	
Water Glass and Cocks -----	Ind 42.21	Ind 42.22
Water Relief Valves -----	Ind 42.19	Ind 42.39
Welded Boilers -----	Ind 41.50	Ind 41.51
Welded Unfired Pressure Vessels -----	Ind 41.50	Ind 41.51
Welding Rules -----	Ind 42.61	
Welded Repairs -----	Ind 42.50	
Welders' Tests and Qualifications -----	Ind 41.50	Ind 42.60
	Ind 42.61	