

WHITE WOODS (WESTERN WOODS) (Surfaced dry or surfaced green)					Western Wood Products Association (See notes 1 and 3)
Select Structural		1550	1630	1,100,000	
No. 1 & Appearance	2x4	1300	1370	1,100,000	
No. 2		1050	1100	1,000,000	
No. 3		600	630	900,000	
Stud		600	630	900,000	
Construction		775	810	900,000	
Standard	2x4	425	450	900,000	
Utility		200	210	900,000	
Select Structural		1300	1370	1,100,000	
No. 1 & Appearance	2x5	1100	1160	1,100,000	
No. 2	and	925	970	1,000,000	
No. 3	wider	550	580	900,000	
Stud		550	580	900,000	

1. When 2-inch lumber is manufactured at a maximum moisture content of 15% (grade-marked MC-15) and used in a condition where the moisture content does not exceed 15%, the design values shown for "surfaced dry or surfaced green" lumber may be increased 8% for design value in bending " F_b ", and 5% for modulus of elasticity "E".

2. National Lumber Grades Authority is the Canadian rules writing agency responsible for preparation, maintenance and dissemination of a uniform softwood lumber grading rule for all Canadian species.

3. Design values for stud grade in 2x5 and wider size classifications apply to 5-inch and 6-inch widths only.

APPENDIX A

CHAPTER ILHR 22

DETERMINING THE LEVEL OF INSULATION

Two methods are outlined for determining the level of insulation required by section ILHR 22.06 using the following sample dwelling:

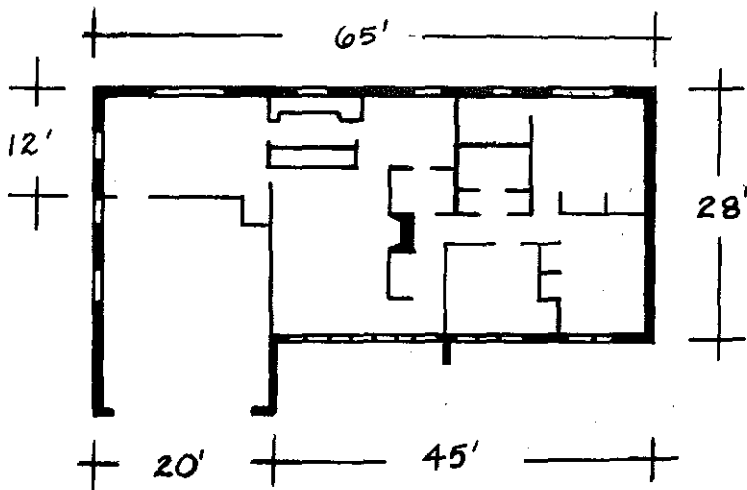

Sample dwelling: 1,500 square feet (186 lineal feet)

- Gross wall area = $8.13' \times 186$ lineal feet = 1,512.18 square feet
- Opaque wall area = 1,301.69 square feet (20% framing, 80% cavity)
- Box sill area = $.81' \times 186$ lineal feet = 150.66 square feet
- Exposed foundation wall area = 108.97 square feet
- Basement window area = 15.65 square feet
- Insulated window area = 172.67 square feet
- Insulated door area = 37.82 square feet
- Ceiling area = 1,500 square feet (10% framing, 90% cavity)

METHOD I - ACCEPTABLE PRACTICE METHOD

The acceptable practice method outlined below can be used with minimum calculations for determining the acceptable level of insulation.

Problem: Using the acceptable practice method determine the level of insulation required for the 1,500 square foot dwelling in Phase I.

Step 1: Determine the percentage window and door area.

$$\begin{aligned} \text{Percent opening area} &= \frac{\text{Window area} + \text{Door area}}{\text{Gross wall area} + \text{Box sill area}} \times 100\% \\ &= \frac{172.67 \text{ sq. ft.} + 37.82 \text{ sq. ft.}}{1512.18 \text{ sq. ft.} + 150.66 \text{ sq. ft.}} \times 100\% \\ &= \frac{210.49 \text{ sq. ft.}}{1,662.84 \text{ sq. ft.}} \times 100\% = 12.66\% \end{aligned}$$

Step 2: Determine level of insulation required for the box sill and side-walls for the given window and door area from Table A-1. (Phase 1)

Using 5/8 inch plywood siding the table shows that an R-11 batt with R-1.22 fiberboard will allow up to 12.8% window and door area.

Step 3: Determine the percentage window area for the exposed foundation wall.

$$\begin{aligned} \text{Percent opening area} &= \frac{\text{Window area}}{\text{Total exposed foundation area}} \times 100\% \\ &= \frac{15.65 \text{ sq. ft.}}{108.97 \text{ sq. ft.} + 15.65 \text{ sq. ft.}} \times 100\% \\ &= 12.6\% \end{aligned}$$

Step 4: Determine the amount of exposed foundation wall: If there is 8" of wall exposed and the wall height is 8',

$$\text{Percent exposed wall} = \frac{8'' / (12'' \text{ per foot})}{8'} \times 100\% = 8.3\%$$

Step 5: Refer to Table A-2 to determine the level of insulation required for the foundation.

Using the requirements for less than 25% exposed foundation wall the table shows that an R-5.27 insulation can be used for up to 24.8% double glazed windows.

Step 6: Select the level of insulation required for the ceiling from Table A-3.

TABLE A-1
WALL INSULATION GUIDE
(Based on U_o requirements above the foundation wall)

Insulation Type	Percent Window and Door Area					
	Phase I		Phase II (4/1/79)		Phase III (4/1/80)	
	$U_o = .14$		$U_o = .13$		$U_o = .12$	
	$\frac{5}{8}$ inch Plywood Siding	Backed Aluminum Siding	$\frac{5}{8}$ inch Plywood Siding	Backed Aluminum Siding	$\frac{5}{8}$ inch Plywood Siding	Backed Aluminum Siding
R-11 Batt	11.0	12.6	8.9	10.5	6.8	8.4
R-11 Batt, R-1.22 Fiberboard	12.8	14.0	10.8	12.0	8.7	9.9
R-11 Batt, R-5.27 Extruded Polystyrene	16.4	17.0	14.4	15.0	12.4	13.0
R-11 Batt, R-10.54 Extruded Polystyrene	18.8	19.1	16.8	17.2	14.9	15.3
R-13 Batt	12.5	13.9	10.4	11.8	8.3	9.8
R-13 Batt, R-1.22 Fiberboard	14.1	15.4	12.2	13.3	10.3	11.2
R-13 Batt, R-5.27 Extruded Polystyrene	17.0	17.5	15.0	15.6	13.1	13.6
R-13 Batt, R-10.54 Extruded Polystyrene	19.2	19.5	17.3	17.6	15.3	15.6
R-19 Batt	15.3	16.2	13.2	14.2	11.2	12.2
R-19 Batt, R-1.22 Fiberboard	16.4	17.1	14.4	15.1	12.3	13.1
R-19 Batt, R-5.27 Extruded Polystyrene	18.6	19.0	16.7	17.0	14.7	15.1
R-19 Batt, R-10.54 Extruded Polystyrene	20.1	20.4	18.2	18.5	16.3	16.6

- Note: The following assumptions were used to derive this table:
1. Door area = 2% of wall and box sill area.
 2. Insulated doors are used with a U-value of .47.
 3. Insulated windows are used with a U-value of .56.
 4. The insulation type is carried down through the box sill.

TABLE A-2
EXPOSED FOUNDATION INSULATION

Foundation exposure	Requirement	Insulation type	Percent window area	
			Single glazed	Double glazed
Less than 25% of foundation exposed	$U_o = .25$	R-5.27	10.4	24.8
		R-11 batt	15.5	34.2
		Multi-cell insul. block (R-12.06)	16.0	35.0
More than 25% of foundation exposed	$U_o = .14$	R-11 batt	4.9	10.8
		R-13 batt	5.8	12.7
	Multi-cell insul. block (R-12.06)	5.5	12.0	
	$U_o = .13$	R-11 batt	3.9	8.7
		R-13 batt	4.8	10.6
	Multi-cell insul. block (R-12.06)	4.5	9.9	
$U_o = .12$	R-11 batt	3.0	6.7	
	R-13 batt	3.9	8.5	
	Multi-cell insul. block (R-12.06)	3.5	7.8	

TABLE A-3
INSULATION LEVELS REQUIRED TO MEET CEILING U VALUES

U_o Value	Insulation	R-Value Required	
		In Cavity	Over Framing
.033	Fiber glass batt	R-19 and R-13	R-13
	Fiber glass blown	12 in. (R-30)	6.4 in. (R-16)
	Rock wool	9.7 in. (R-29)	4.2 in. (R-13)
	Cellulose	8.4 in. (R-31)	2.9 in. (R-11)
.029	Fiber glass batt	R-38	R-19
	Fiber glass blown	13.6 in. (R-34)	8.1 in. (R-20)
	Rock wool	10.9 in. (R-33)	5.4 in. (R-16)
	Cellulose	9.5 in. (R-35)	4.0 in. (R-15)

Note: The following assumptions are used:
 1. Fiber glass blown = R-2.5 per inch
 2. Rock wool = R-3.0 per inch
 3. Cellulose = R-3.7 per inch

METHOD II — SYSTEM DESIGN METHOD

The system design method is the more complex method of determining the level of insulation required by the code. This procedure may be used when it becomes necessary to combine various materials to comply with the code. If the window area is increased and the same wall insulation is

used, the wall section will not meet the requirements of section ILHR 22.06 (6), but the system design method can be used by adding extra insulation elsewhere.

Problem: Using the system design method, increase the opening area to 15% and determine compliance by adding extra insulation to the walls and ceiling.

Step 1: Determine the inside and outside design temperatures from Tables 22.04-A and B.

Inside temperature = 70° F

Outside temperature = -20° F

$\Delta T = T_{\text{inside}} - T_{\text{outside}} = 70 - (-20) = 90^\circ \text{ F}$.

Note: Degree days may be used for system design instead of design temperatures:

Zone 1, 9,000 degree days

Zone 2, 8,000 degree days

Zone 3, 7,500 degree days

Zone 4, 7,000 degree days

Step 2: Using section ILHR 22.06, determine the insulation values for the exterior walls above grade and the roof/ceiling for Phase I.

Exposed exterior walls above grade; $U_o = .15$

Roof/ceiling; $U_o = .033$

Step 3: Fill in the worksheet to determine requirements for building enclosure heat loss.

Step 4: Select the levels of insulation to be used and determine the U values for the ceiling, wall, box sill and foundation (shown in Figure A-1). Fill in the building enclosure worksheet.

Step 5: If the total heat loss determined through the system design method is within one percent or is less than the heat loss determined through the code requirements, the code has been satisfied.

INDUSTRY, LABOR AND HUMAN RELATIONS
R-VALUE DETERMINATION BY COMPONENT

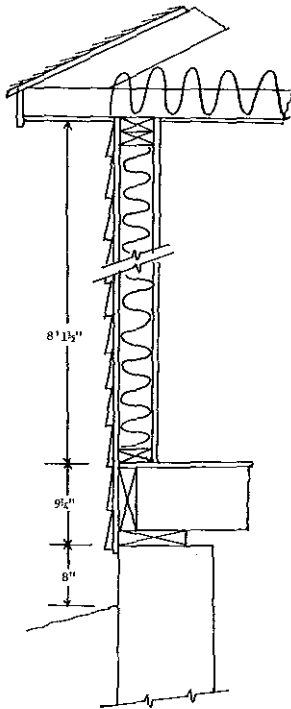

Figure A-1

<u>Ceiling</u>	<u>Cavity R</u>	<u>Joist R</u>
Top surface	.17	.17
Insulation	38.0	19.0
Wood	—	6.88
1/2" gyp. wall board	.45	.45
Bottom surface	.61	.61
	39.23	27.11
	(U = .025)	(U = .037)

<u>Wall</u>	<u>Cavity R</u>	<u>Stud R</u>
Outside surface	.17	.17
3/8" ext. siding	.77	.77
Rigid insulation	—	—
Insulation	11.00	—
Wood stud	—	4.38
1/2" gyp. wall board	.45	.45
Inside surface	.68	.68
	13.07	6.45
	(U = .070)	(U = .13)

<u>Box sill</u>	<u>R</u>
Outside surface	.17
3/8" ext. siding	.77
Rigid insulation	—
Insulation	11.00
1 1/2" wood	1.88
Inside surface	.68
	14.50
	(U = .064)

<u>Foundation</u>	<u>R</u>
Outside surface	.17
8" concrete	.64
Inside surface	.68
Rigid insulation	5.27
	6.76
	(U = .15)

WORKSHEET FOR SYSTEM DESIGN ANALYSIS

CODE REQUIREMENTS				
Component	U _o Req'd.	Area	ΔT	Heat Loss
Walls				
Above grade	.15	1512.18	90	20,414.4
Box sill	.15	150.66	70	1,581.9
Foundation	.15	124.62	70	1,308.5
Roof/Ceiling	.033	1500.00	90	4,455.0
Floor				
Over unheated spaces				
Slab-on-grade				
TOTAL				27,759.9

SYSTEM DESIGN ALTERNATIVE				
Component	U	Area	ΔT	Heat Loss
Walls				
Cavity	.070	1010.20	90	6,364.3
Solid	.13	252.60	90	2,955.4
Box sill	.064	150.66	70	675.0
Foundation	.15	108.97	70	1,114.2
Roof/Ceiling				
Cavity	.025	1350.00	90	3,037.5
Solid	.037	150.00	90	499.5
Floor				
Over unheated spaces				
Slab-on-grade				
Windows	.56	211.61	90	10,665.1
Doors	.31	37.82	90	1,055.2
Basement windows	1.13	15.65	70	1,237.9
TOTAL				27,634.1

WORKSHEET FOR SYSTEM DESIGN ANALYSIS

CODE REQUIREMENTS				
Component	U _o Reqd.	Area	ΔT	Heat Loss
Walls				
Above grade				
Box sill				
Foundation				
Roof/Ceiling				
Floor				
Over unheated spaces				
Slab-on-grade				
TOTAL				

SYSTEM DESIGN ALTERNATIVE				
Component	U	Area	ΔT	Heat Loss
Walls				
Cavity				
Solid				
Box sill				
Foundation				
Roof/Ceiling				
Cavity				
Solid				
Floor				
Over unheated spaces				
Slab-on-grade				
Windows				
Doors				
Basement windows				
TOTAL				

TABLE A-1
COMMON CONSTRUCTION MATERIAL R-VALUES*

Material	Description	Density (lb per cu ft)	Per inch	For thick-
			thickness R-Value	ness listed R-Value
BUILDING	Asbestos-cement board.....	120	0.25	—
BOARD	Asbestos-cement			
Boards,	board	1/2 in. 120	—	0.03
panels,	Asbestos-cement			
subflooring,	board	1/4 in. 120	—	0.06
sheathing,	Gypsum or plaster			
woodbased panel	board	3/4 in. 50	—	0.32
products	Gypsum or plaster			
	board	1/2 in. 50	—	0.45
	Plywood.....	34	1.25	—
	Plywood.....	1/4 in. 34	—	0.31
	Plywood.....	3/8 in. 34	—	0.47
	Plywood.....	1/2 in. 34	—	0.62
	Plywood or wood			
	panels	3/8 in. 34	—	0.93
	Insulating board			
	Sheathing, reg.			
	density	1/2 in. 18	—	1.32
 25/32 in.	18	—	2.06
	Sheathing, intermediate			
	density	1/2 in. 22	—	1.22
	Nail-base			
	sheathing.....	1/2 in. 25	—	1.14
	Shingle backer	3/8 in. 18	—	0.94
	Shingle backer	5/16 in. 18	—	0.78
	Sound deadening			
	board	1/2 in. 15	—	1.35
	Tile and lay-in panels,			
	plain or acoustic.....	18	2.50	—
 1/2 in.	18	—	1.25
 3/8 in.	18	—	1.89
	Laminated paperboard.....	30	2.00	—
	Homogeneous board from			
	repulped paper	30	2.00	—
	Hardboard			
	Medium density			
	siding	7/16 in. 40	—	0.67
	Other medium density.....	50	1.37	—
	High density, underlay.....	55	1.22	—
	High density std. tempered ..	63	1.00	—
	Particleboard			
	Low density	37	1.85	—

Material	Description	Density (lb per cu ft)	Per inch thickness R-Value	For thick- ness listed R-Value
	Medium density	50	1.06	—
	High density	62.5	0.85	—
	Underlayment ¾ in.	40	—	0.82
	Wood subfloor ¾ in.	—	—	0.94
BUILDING PAPER	Vapor-permeable felt.....	—	—	0.06
	Vapor-seal, 2 layers of mopped 15 lb. felt	—	—	0.12
	Vapor-seal, plastic film.....	—	—	Negl.
ROOF INSULATION	Preformed, for use above deck			
	Approximately ½ in.	—	—	1.39
	Approximately 1 in.	—	—	2.78
	Approximately 1½ in.	—	—	4.17
	Approximately 2 in.	—	—	5.56
	Approximately 2½ in.	—	—	6.67
	Approximately 3 in.	—	—	8.33
	Cellular glass.....	9	2.50	—
MASONRY MATERIALS	Cement mortar	116	0.20	—
Concrete	Gypsum-fiber concrete			
	87½% gypsum, 12½% wood chips	51	0.60	—
	Lightweight aggregates including expanded shale, clay or slate, expanded slags; cinders; pumice; vermiculite; also cellular concretes	120 100 80 60 40 30 20	0.19 0.28 0.40 0.59 0.86 1.11 1.43	— — — — — — —
	Perlite.....	40	1.08	—
	30	1.41	—
	20	2.00	—
	Sand and gravel or stone ag- gregate (oven dried).....	140	0.11	—
	Sand and gravel or stone ag- gregate (not dried).....	140	0.08	—
	Stucco.....	116	0.20	—
MASONRY UNITS	Brick, common.....	120	0.20	—
	Brick, face.....	130	0.11	—
	Clay tile, hollow:			
	1 cell deep 3 in.	—	—	0.80
	1 cell deep 4 in.	—	—	1.11
	2 cells deep 6 in.	—	—	1.52
	2 cells deep 8 in.	—	—	1.85
	2 cells deep 10 in.	—	—	2.22
	3 cells deep 12 in.	—	—	2.50
	Concrete blocks, 3 oval core:			
	Sand & gravel aggregate.....	4 in.	—	0.71
	8 in.	—	—	1.11
	12 in.	—	—	1.28
	Cinder aggregate ...	3 in.	—	0.86
 4 in.	—	—	1.11
 8 in.	—	—	1.72
 12 in.	—	—	1.89
	Lightweight aggregate(expanded shale, clay, slate or slag; pumice)	3 in. 4 in. 8 in. 12 in.	— — — —	1.27 1.50 2.00 2.27
	Concrete blocks, rectangular core			
	Sand & gravel aggregate			
	2 core, 8" 36 lb	—	—	1.04

Material	Description	Density lb per cu ft)	Per inch thickness R-Value	For thick ness listed R-Value
	Same with filled cores	—	—	1.93
	Lightweight aggregate (expanded shale, clay, slate or slag, pumice).....	—	—	—
	3 core, 6" 19 lb	—	1.65	—
	Same with filled cores	—	—	—
	2 core, 8" 24 lb	—	2.99	—
	Same with filled cores	—	—	—
	3 core, 12" 38 lb	—	2.18	—
	Same with filled cores	—	—	—
	3 core, 12" 38 lb	—	5.08	—
	Same with filled cores	—	—	—
	3 core, 12" 38 lb	—	2.48	—
	Same with filled cores	—	—	—
	3 core, 12" 38 lb	—	5.82	—
	Stone, lime or sand	—	0.08	—
	Gypsum partition tile:	—	—	—
	3 x 12 x 30 in. solid	—	—	1.26
	3 x 12 x 30 in. 4-cell	—	—	1.35
	4 x 12 x 30 in. 3-cell	—	—	1.67
PLASTERING MATERIALS	Cement plaster, sand aggregate	116	0.20	—
	Sand aggregate..... ¾ in.	—	—	0.08
	Sand aggregate..... ¾ in.	—	—	0.15
	Gypsum plaster:	—	—	—
	Lightweight aggregate..... ½ in.	45	—	0.32
	Lightweight aggregate..... ¾ in.	45	—	0.39
	Lightweight aggregate on metal lath..... ¾ in.	—	—	0.47
	Perlite aggregate..... 45	—	0.67	—
	Sand aggregate..... 105	—	0.18	—
	Sand aggregate..... ½ in.	105	—	0.09
	Sand aggregate..... ¾ in.	105	—	0.11
	Sand aggregate on metal lath..... ¾ in.	—	—	0.1
	Vermiculite aggregate..... 45	—	0.59	—
ROOFING	Asbestos-cement shingles	120	—	0.21
	Asphalt roll roofing	70	—	0.15
	Asphalt shingles	70	—	0.44
	Built-up roofing..... ¾ in.	70	—	0.33
	Slate..... ½ in.	—	—	0.05
	Wood shingles, plain plastic film faced ...	—	0.94	—
SIDING MATERIALS (On flat surface)	Shingles:	—	—	—
	Asbestos-cement.....	120	—	0.21
	Wood, 16", 7½" exposure.....	—	—	0.87
	Wood, double, 16", 12" exposure.....	—	—	1.19
	Wood, plus insulating backer board..... 5/16 in.	—	—	1.40
	Siding:	—	—	—
	Asbestos-cement, ¼" lapped	—	—	0.21
	Asphalt roll siding.....	—	—	0.15
	Asphalt insulating siding (½" bd.).....	—	—	1.46
	Wood drop 1 x 8".....	—	—	0.79
	Wood bevel, ½" x 8" lapped.....	—	—	0.81

Material	Description	Density (lb per cu ft)	Per inch thickness R-Value	For thick- ness listed R-Value
	Wood bevel, $\frac{3}{4}$ x 10" lapped	—	—	1.05
	Wood plywood $\frac{3}{4}$ " lapped	—	—	0.59
	Aluminum or steel, over sheathing, hollow-backed	—	—	0.61
	Insulating-board backed nominal $\frac{3}{8}$ "	—	—	1.82
	Insulating-board backed nominal $\frac{3}{8}$ " foil backed	—	—	2.96
	Architectural glass	—	—	0.10
FINISH FLOORING MATERIALS	Carpet and fibrous pad	—	—	2.08
	Carpet and rubber pad	—	—	1.23
	Cork tile	$\frac{1}{2}$ in.	—	0.28
	Terrazzo	1 in.	—	0.08
	Tile-asphalt, linoleum, vinyl, rubber	—	—	0.05
	Wood, hardwood finish	$\frac{3}{4}$ in.	—	0.08
INSULATING MATERIALS Blanket and batt	Mineral fiber, fibrous form processed from rock, slag or glass			
	Approx. 2 to 2 $\frac{3}{4}$ " ... Note 1	—	—	7
	Approx. 3 to 3 $\frac{1}{2}$ " ... Note 1	—	—	11
	Approx. 5 $\frac{1}{4}$ to 6 $\frac{1}{2}$ "	Note 1	—	19
Board and Slabs	Cellular glass	9	2.50	—
	Glass fiber, organic bonded	4-9	4.00	—
	Expanded rubber (rigid)	4.5	4.55	—
	Expanded polystyrene ex- truded, plain	1.8	4.00	—
	Expanded polystyrene ex- truded (R-12 exp.)	2.2	5.00	—
	Expanded polystyrene ex- truded (R-12 exp.) (Thickness 1" and greater)	3.5	5.26	—
	Expanded polystyrene, molded beads	1.0	3.57	—
	Expanded polyurethane (R-11 exp.)	1.5	6.25	—
	Mineral fiber with resin binder.	15	3.45	—
	Mineral fiberboard wet felted			
	Core or roof insulation	16-17	2.94	—
	Acoustical tile	18	2.86	—
	Acoustical tile	21	2.70	—
	Mineral fiberboard wet molded			
	Acoustical tile	23	2.38	—
	Wood or cane fiberboard			
	Acoustical tile	$\frac{1}{2}$ in.	—	1.25
	Acoustical tile	$\frac{3}{4}$ in.	—	1.89
	Interior finish (plank, tile)	15	2.86	—
	Insulating roof deck			
	Approximately	1 $\frac{1}{2}$ in.	—	4.17
	Approximately	2 in.	—	5.56
Approximately	3 in.	—	8.33	
Wood shredded (cemented in preformed slabs)	22	1.67	—	
Loose Fill	Cellulose insulation (milled paper or wood pulp)	2.5-3	3.70	—
	Sawdust or shavings	0.8-1.5	2.22	—
	Wood fiber, softwoods	2.0-3.5	3.33	—
	Perlite, expanded	5.0-8.0	2.70	—

Material	Description	Density lb per cu ft)	Per inch thickness R-Value	For thick ness listed R-Value
	Mineral fiber (rock, slag or glass);			
	Approximately			
	3"..... Note 1	8-15	—	9
	Approximately			
	4½"..... Note 1	8-15	—	13
	Approximately			
	6¾"..... Note 1	8-15	—	19
	Approximately			
	7½"..... Note 1	8-15	—	24
	Silica aerogel.....	7.6	5.88	—
	Vermiculite (expanded).....	7.0-8.2	2.13	—
	4.0-6.0	2.27	—
WOODS	Maples, oak and similar			
	hardwoods.....	45	0.91	—
	Fir, pine, and similar			
	softwoods.....	32	1.25	—
	Fir, pine, and simi-			
	lar softwoods.....	¾ in. 32	—	0.94
	1½ in. 32	—	1.89
	2½ in. 32	—	3.12
	3½ in. 32	—	4.35

Note 1: R-value varies with fiber diameter. Insulation is produced by different densities; therefore, there is a wide variation in thickness for the same R-value between various manufacturers. (See Batt and Loose Fill Insulation.)

*Reprinted with permission from ASHRAE Handbook of Fundamentals 1972.

TABLE A-5
 COEFFICIENTS OF TRANSMISSION (U) OF WINDOWS, SKYLIGHTS, AND LIGHT TRANSMITTING PARTITIONS*
 (These values are for heat transfer from air to air.)
 Btu per (hr) (sq ft) (F Deg)

PART A
 VERTICAL PANELS (EXTERIOR WINDOWS, SLIDING PATIO DOORS
 AND PARTITIONS)—FLAT GLASS, GLASS BLOCK AND PLASTIC
 SHEET

Description	Exterior ¹		Interior
	Winter	Summer	
Flat Glass			
single glass	1.13	1.06	0.73
insulating glass—double ²			
3/16 in. air space	0.69	0.64	0.51
1/4 in. air space	0.65	0.61	0.49
1/2 in. air space	0.58	0.56	0.46
1/2 in. air space, low emissivity coating ³			
emissivity = 0.20	0.38	0.36	0.32
emissivity = 0.40	0.45	0.44	0.38
emissivity = 0.60	0.52	0.50	0.42
insulating glass—triple ²			
1/4 in. air spaces	0.47	0.45	0.38
1/2 in. air spaces	0.36	0.35	0.30
storm windows			
1 in.-4 in. air space	0.56	0.54	0.44
Glass Block ⁴			
6 x 6 x 4 in. thick	0.60	0.57	0.46
8 x 8 x 4 in. thick	0.56	0.54	0.44
—with cavity divider	0.48	0.46	0.38
12 x 12 x 4 in. thick	0.52	0.50	0.41
—with cavity divider	0.44	0.42	0.36
12 x 12 x 2 in. thick	0.60	0.57	0.46
Single Plastic Sheet	1.09	1.00	0.70

PART B
 HORIZONTAL PANELS (SKYLIGHTS)
 FLAT GLASS, GLASS BLOCK AND PLASTIC BUBBLES

Description	Exterior ¹		
	Winter ⁵	Summer ⁶	Interior ⁵
Flat Glass			
single glass	1.22	0.83	0.96
insulating glass—double ²			
3/16 in. air space	0.75	0.49	0.62
1/4 in. air space	0.70	0.46	0.59
1/2 in. air space	0.66	0.44	0.56
1/2 in. air space, low emissivity coating ³			
emissivity = 0.20	0.46	0.31	0.39
emissivity = 0.40	0.53	0.36	0.45
emissivity = 0.60	0.60	0.40	0.50
Glass Block ⁴			
11 x 11 x 3 in. thick with cavity divider	0.53	0.35	0.44
12 x 12 x 4 in. thick with cavity divider	0.51	0.34	0.42
Plastic Bubbles ⁷			
single walled	1.15	0.80	—
double walled	0.70	0.46	—

⁵For heat flow up.

⁶For heat flow down.

⁷Based on area of opening, not total surface area.

(See following page for Part C of this table.)

¹See Part C for adjustment for various window and sliding patio door types.

²Double and triple refer to the number of lights of glass.

³Coating on either glass surface facing air space; all other glass surfaces uncoated.

⁴Dimensions are nominal.

*Reprinted with permission from ASHRAE Handbook of Fundamentals.

PART C
ADJUSTMENT FACTORS FOR VARIOUS WINDOW AND SLIDING PATIO DOOR
TYPES
 (Multiply U values in Parts A and B by these factors)

Description	Single Glass	Double or Triple Glass	Storm Windows
Windows			
All Glass ⁶	1.00	1.00	1.00
Wood Sash—80% Glass	0.90	0.95	0.90
Wood Sash—60% Glass	0.80	0.85	0.80
Metal Sash—80% Glass	1.00	1.20	1.20 ⁹
Sliding Patio Doors			
Wood Frame	0.95	1.00	—
Metal Frame	1.00	1.10	—

⁶Refers to windows with negligible opaque area.

⁹Value becomes 1.00 when storm sash is separated from prime window by a thermal break.

TABLE A-6
COEFFICIENTS OF TRANSMISSION (U) FOR SLAB DOORS*
 Btu per (hr) (sq ft) (F Deg)

Thickness ¹	Winter			Summer, No Storm Door
	Solid Wood, No Storm Door	Storm Door ²		
		Wood	Metal	
1 in.	0.64	0.30	0.39	0.61
1¼ in.	0.55	0.28	0.34	0.53
1½ in.	0.49	0.27	0.33	0.47
2 in.	0.43	0.24	0.29	0.42
Steel Door				
1½ in.				
A ³	0.59	—	—	0.58
B ⁴	0.40	—	—	0.39
C ⁵	0.47	—	—	0.46

¹Nominal thickness.

²Values for wood storm doors are for approximately 50% glass; for metal storm doors values apply for any percent of glass.

³A = Mineral fiber core (2 lb/cu ft).

⁴B = Solid urethane foam core.

⁵C = Solid polystyrene core.

Note: Hollow core doors 1½ in. thick - R = 2.17; U = 0.46

1½ in. thick - R = 2.22; U = 0.45

*Reprinted with permission from ASHRAE Handbook of Fundamentals.

APPENDIX B

**FORMULA FOR DETERMINING
THE OVERALL U_o
OF THE WALL**

$$U_o = \frac{U_{cav} A_{cav} + U_{sol} A_{sol} + U_{win} A_{win} + U_{door} A_{door} + U_{box} A_{box} + U_{found} A_{found}}{A_o}$$

Where:

- U_o = Average thermal transmittance of gross wall area
- A_o = Gross area of exterior walls.
- U_{cav} = Thermal transmittance of cavity area (usually assume 80%)
- A_{cav} = Area between wall framing where insulation may be placed.
- U_{sol} = Thermal transmittance of wood framing area.
- A_{sol} = Area of wood framing (usually assume 20%)
- U_{box} = Thermal transmittance of box sill area.
- A_{box} = Area of box sill
- U_{found} = Thermal transmittance of foundation area.
- A_{found} = Area of above grade exposed concrete.
- U_{win} = Thermal transmittance of window.
- A_{win} = Total glass area.
- U_{door} = Thermal transmittance of door.
- A_{door} = Total door area.

**FORMULA FOR DETERMINING
THE OVERALL U_o
OF THE CEILING**

$$U_o = \frac{U_{cav} A_{cav} + U_{sol} A_{sol} + U_{skylight} A_{skylight}}{A_o}$$

Where:

- U_o = Average thermal transmittance of gross roof/ceiling.
- A_o = Gross area of roof/ceiling assembly.
- U_{cav} = Thermal transmittance of cavity area.
- A_{cav} = Area between wood framing.
- U_{sol} = Thermal transmittance of framing.
- A_{sol} = Area of wood framing (usually assume 10%)
- $U_{skylight}$ = Thermal transmittance of skylight elements.
- $A_{skylight}$ = Area of skylight (including frame).

APPENDIX C

**INSULATION, EQUIPMENT
AND CONDENSATION CONTROL**

This appendix is a guide for the proper installation of insulation. The preceding appendices indicated the required amounts and types of insulation necessary to provide the various thermal resistance values for the

building envelope. In order to attain the resistance values specified, it is important that the insulation be properly installed. This appendix includes types of materials currently available and common application practices.

Condensation control should be provided in the form of vapor barriers and thermal breaks. Vapor barriers should be installed on the warm side (area heated in winter) of all walls, ceilings, and insulated floors. All metal window, skylight, and door frames should contain a thermal break.

Insulation is manufactured in many forms and types. The most commonly used materials in residential construction are batts and blankets, rigid insulation, reflective insulation, loose fill, and sprayed insulation. The following is a list of types of materials and the federal specifications governing their characteristics.

Cork board	FS HH-I-561
Cellular glass	FS HH-I-551
Duct insulation	FS HH-I-558b
Expanded polystyrene insulation board	FS HH-I-524
Fiberboard	FS LLL-I-535 or ASTM C-208 Class C
Insulation board (urethane)*.....	FS HH-I-530
Insulation, thermal (perlite)	FS HH-I-574
Mineral fiber, pneumatic or poured	FS HH-I-1030A
Mineral fiber, insulation blanket	FS HH-I-521E
Perlite.....	FS HH-I-526a
Perimeter insulation.....	FS HH-I-524a
	Type II
.....	FS HH-I-558b Form A, Class 1 or 2
Reflective, thermal.....	FS HH-I-1552
Structural fiberboard insulation roof deck ...	AIMA IB Spec. No. 1
Cellulose; vegetable or wood fiber.....	FS HH-I-515b-25
Vermiculite	FS HH-I-585
Vermiculite, water repellent loose fill.....	FHA UM-30
Mineral fiber, roof insulation.....	HH-I-526c

BATTS AND BLANKETS

These materials are usually identified on the package and on the vapor barrier facing with their "R" values. Under the federal specifications, there are 3 standard products identified as R-7, R-11, and R-19. These values are based on the insulation value of the mass. Some manufacturers offer other products such as R-8, R-13 and R-22. The specific thickness of insulation required for a specific "R" value may vary from one manufacturer to another due to differences in base materials and manufacturing processes.

General Guidelines

1. Install insulation so the vapor barrier faces the interior of the dwelling.
2. Vapor barriers should not be left exposed.
3. Insulate all voids of the building envelope including small spaces, gaps, around receptacles, pipes, etc.

4. Place insulation on the cold side of pipes and ducts (see Fig. 4). Insulation is not required for supply and return air ducts in heated basements and cellars.

Ceilings

There is a variety of methods for installing blanket insulation in ceilings.

1. Fastening from below (Fig. 1b).
2. Installing unfaced (without a vapor barrier), friction-fit blankets (Fig. 2).
3. Laying the insulation in from above when the ceiling finish material is in place (Fig. 1a).

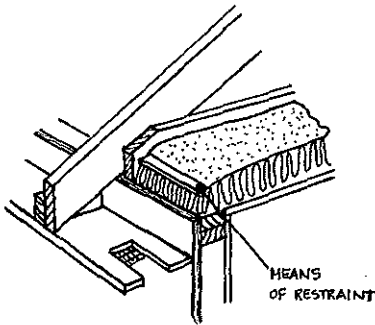

Fig. 1a

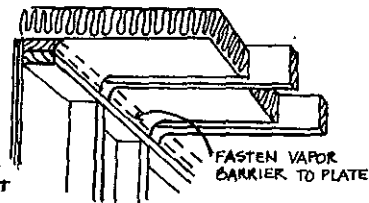

Fig. 1b

Fasten flanges to the inside of ceiling joists as shown in Fig. 1b. Extend the insulation entirely across the top plate, keeping the blanket as close to the plate as possible. Fasten vapor barrier to plate. When eave vents are used, the insulation should not block air movement from eave to space above insulation (Fig. 1a).

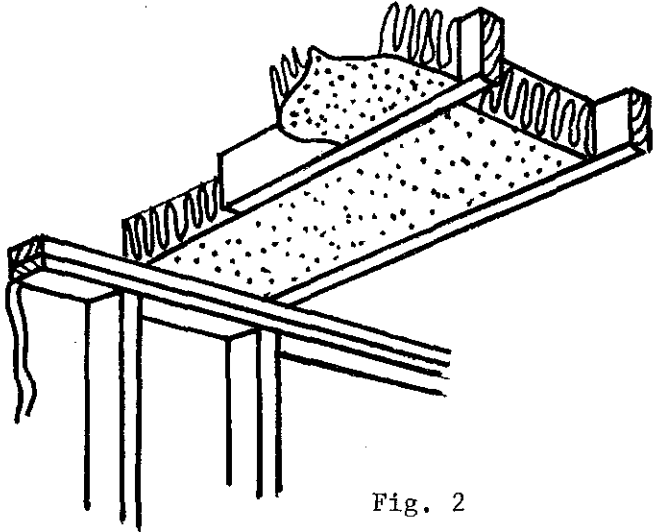

Fig. 2

Insert friction-fit blankets between ceiling joists (Fig. 2). Allow insulation to overlap the top plate of the exterior wall, but not enough to block eave ventilation. The insulation should be in contact with the top of the plate to avoid heat loss and air infiltration beneath the insulation. The required vapor barrier is not shown.

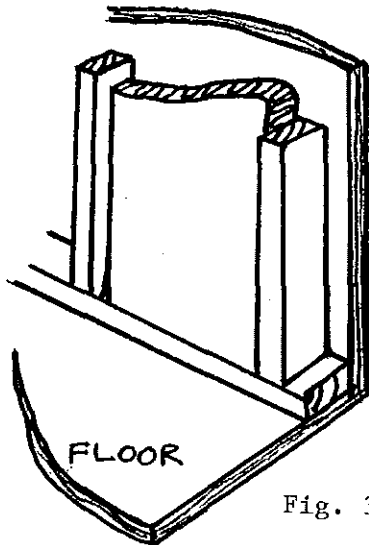

Fig. 3

Insert blankets into stud spaces. Working from the top down, space fasteners per manufacturers recommendations, fitting flanges tightly

against face of stud (Fig. 3). Cut blankets slightly over length and fasten the vapor barrier to the top and bottom plates.

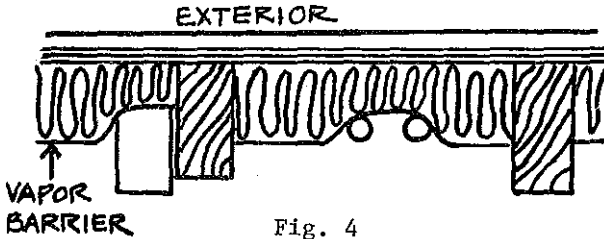

Fig. 4

Insert insulation behind (cold side in winter) pipes, ducts, and electrical boxes (Fig. 4).

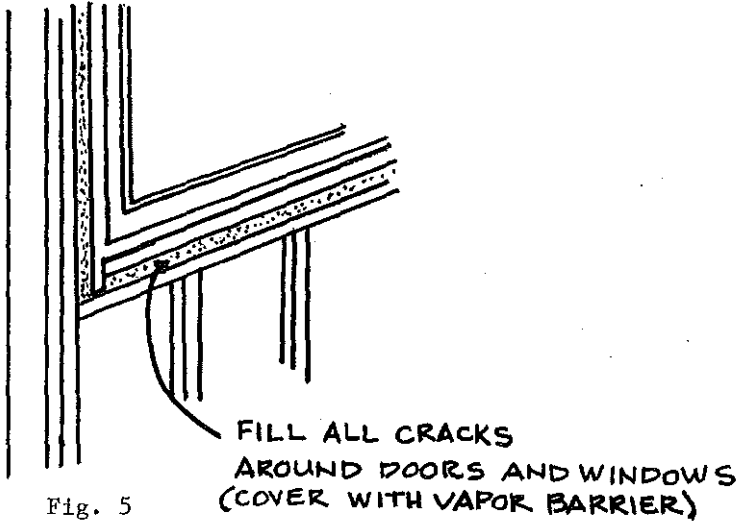

Fig. 5

Fill small spaces between rough framing and door and window heads, jambs and sills with pieces of insulation (Fig. 5).

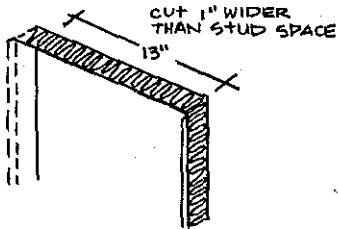

Fig. 6a

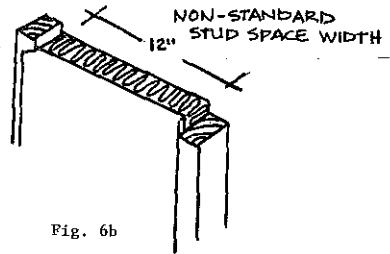

Fig. 6b

Insulate nonstandard-width stud or joist spaces by cutting the insulation and vapor barrier an inch or so wider than the space to be filled (Fig. 6a). Pull the vapor barrier on the cut side to the other stud, compressing the insulation behind it, and fasten through vapor barrier to stud face (Fig. 6b). Unfaced blankets are cut slightly oversize and fitted into place.

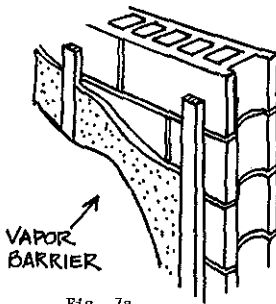

Fig. 7a

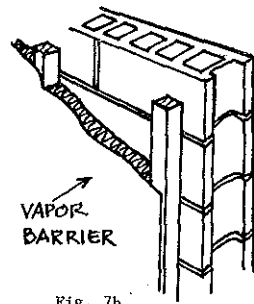

Fig. 7b

Masonry walls may be insulated by inserting insulation between furring strips spaced at 16 or 24 inches o.c. (Fig. 7a and 7b). It is recommended to apply the vapor barrier to the inside surface.

Floor and Crawl Spaces

Fig. 8a

Fig. 8b

Floors over crawl spaces (Fig. 8a) should be insulated either by insulating the foundation walls or by placing insulation on or between the joists. Insulation should be securely fastened. In all cases, the vapor barrier side of the insulation should face the floor above; that is, be adjacent to the warm side in winter. A vapor barrier should be used to cover the ground.

Dropped Soffits

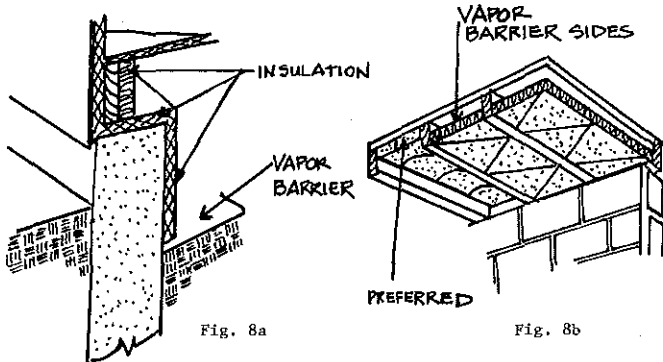
Insulation of dropped soffits over kitchen cabinets, bathtubs, showers, or similar areas, need special attention when they are exposed to the attic. If the dropped soffit is framed before ceiling finish material is applied, a "board" (plywood, hardboard, gypsumboard, etc.) should be installed over the cavity to support insulation.

In multiple dwellings with back-to-back kitchens or baths, it is necessary to extend ceiling finish material over dropped soffits to the party wall to avoid loss of acoustical control and to provide adequate fire stops.

Rigid Insulation

Rigid insulation is available in various sizes and thicknesses made of polystyrene, polyurethane, cork, cellular glass, mineral fiber (glass or rock wool), perlite, wood fiberboard, etc. They are used as insulation for masonry construction, as perimeter insulations around concrete slabs, as exterior sheathing under the weather barrier, as rigid insulations on top of roof decks, and other applications. Rigid insulations, such as polystyrene and polyurethane, are vapor barriers and, in most applications, will not require the installation of a separate barrier.

Installation Procedures

Masonry walls: Rigid insulations are applied to either face of a masonry wall (Fig. 9a and 9c) or are used as a cavity insulation between two wythes of masonry (Fig. 9b). When applied to the face of masonry walls, they are generally installed with adhesive and/or mechanical fasteners. The manufacturer's recommendation should be followed.

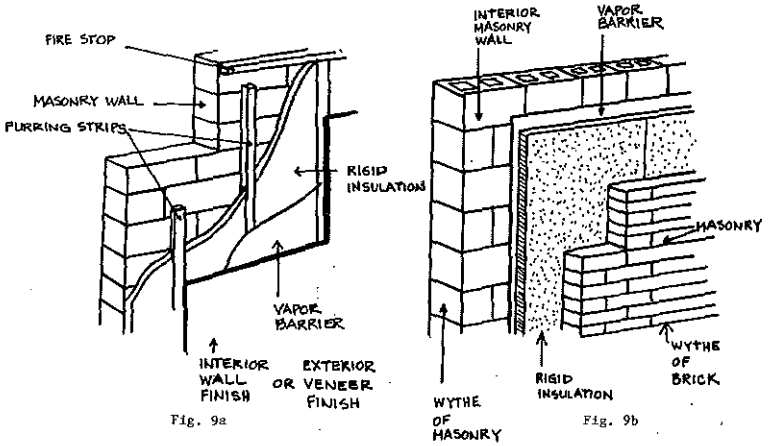

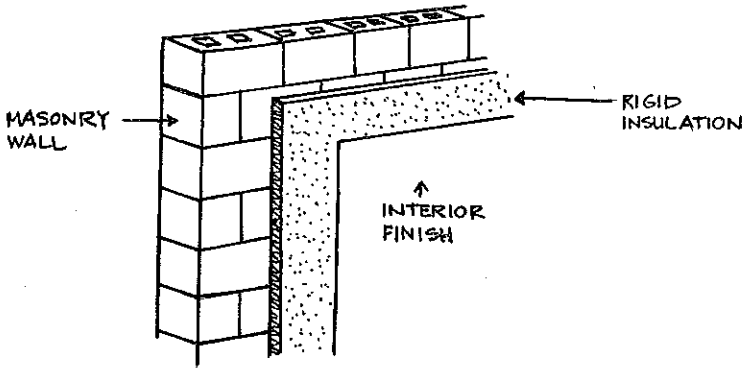

Fig. 9c

Frame Construction: When rigid insulation is used with frame construction (Fig. 10), it is usually applied as sheathing to the outside of the framing, and mechanically attached with nails to wood studs or to metal studs with screws or clips or other approved methods.

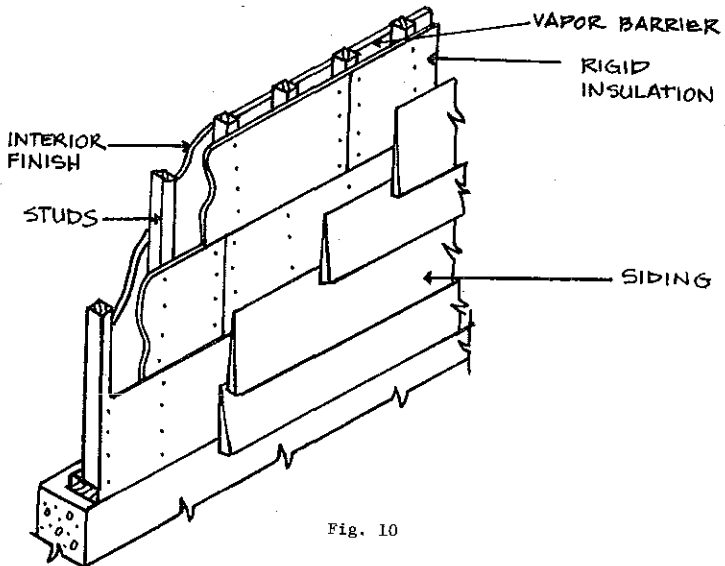

Fig. 10

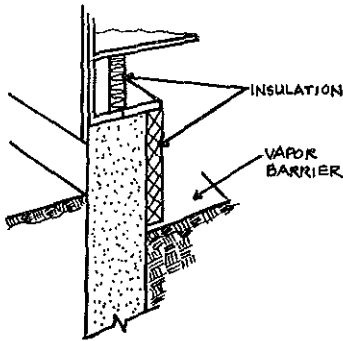

Fig. 11a

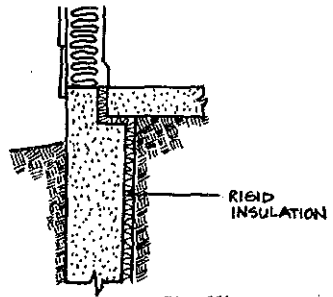

Fig. 11b

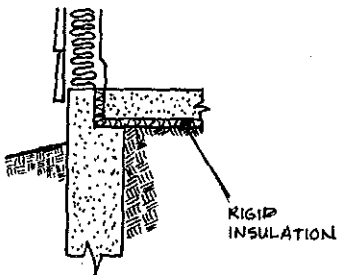

Fig. 11c

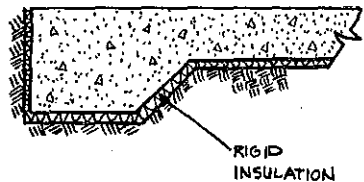

Fig. 11d

Roof Insulation: Roof insulation boards are usually installed with an approved adhesive, hot asphalt, or may be nailed to the roof sheathing. The manufacturer's instructions should be followed.

Slab-on-Grade: Rigid insulation is frequently used as insulation around the perimeter of concrete slabs-on-grade (Fig. 11b, c, d) and also may be used on the inside of foundation walls adjacent to heated crawl spaces, basements or cellars (Fig. 11a). Installation is usually accomplished with adhesive and/or mechanical fasteners. Perimeter insulation should be installed against the foundation wall or extended into the interior of the building to a distance equal to the design frost line (Fig. 11b, c and d). Where the slab bears on the foundation ledge, the insulation should be a load-bearing type.

INSULATED CONCRETE BLOCK

Concrete block manufacturers are currently producing several types of multi-celled block with improved insulating values. The thermal resistance of the block will vary depending upon the types of insulation used and the configuration of the cells. An example of a typical multi-celled block is shown below.

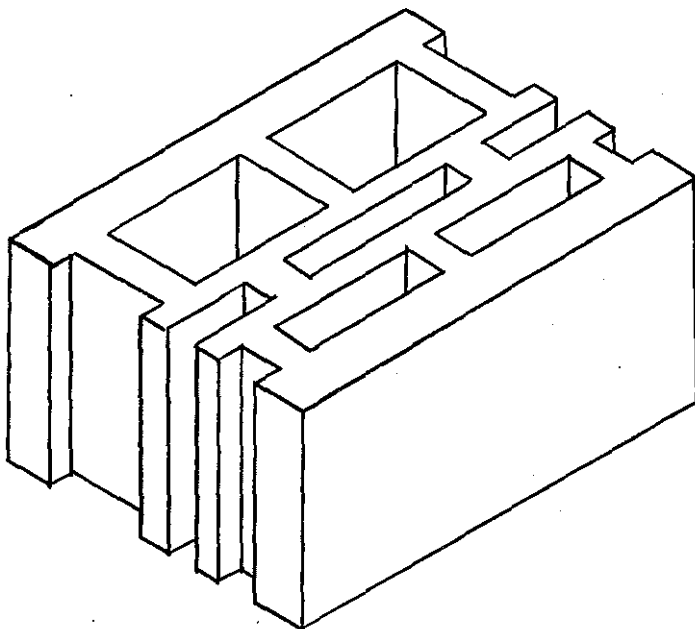

LOOSE FILL INSULATION

Materials of this type are those made from mineral fibers (rock or glass), cellulose materials (wood fibers or shredded paper), or other manufactured products that can easily be poured.

BLOWN ATTIC INSULATION

There are several factors pertaining to blown attic insulation that can cause differences in its installed thermal resistance value (R). For a given manufacturer's insulation, the installed thermal resistance (R) value depends on thickness and weight of insulating material applied per square foot. Federal specification HH-I-1030A for insulation requires that each bag of insulation be labeled to show the minimum thickness, the maxi-

imum net coverage, and the minimum weight of (that particular) insulation material required per square foot to produce resistance values of R-30, 22, 19, and 11. A bag label example for blown insulation is shown in Fig. 12.

The number of bags of blown insulation required to provide a given R-value to insulate an attic of a given size may be calculated from data provided by the manufacturer. If only the thickness of blown attic insulation is specified, and the density or number of bags is not, the desired or assumed thermal resistance (R) value may not be achieved. The important characteristic is weight per square foot. Thickness is the minimum thickness, not the average thickness experienced in the field.

Adequate baffling of the vent opening or insulation blocking should be provided so as to deflect the incoming air above the surface of the installed blown or poured insulation. Baffles should be made of durable material securely fastened. Baffles should be in place at the time of framing inspection.

Three blown insulations that provide R-19 are:

Material	Minimum Thickness	Maximum Net Coverage/Bag	Bags/1000 Sq. Ft.
Cellulose	5½"	59 sq. ft. (40 lb. bag)	17
Glass fiber	8¾"	51 sq. ft. (24 lb. bag)	20
Rock wool	6½"	26 sq. ft. (27 lb. bag)	38

Bag Label Example: The manufacturer recommends these maximum coverages at these minimum thicknesses to provide the levels of installed insulation resistance (R) values shown:

(Based on 25-pound nominal weight bag)

R-Value	Minimum Thickness	Minimum Weight per Sq. Ft.	Bags per 1000 Sq. Ft.	Maximum Net Coverage per Bag
To obtain an insulation resistance R of:	Installed insulation should not be less than:	The weight per sq. ft. of installed insulation should be not less than:	Number of bags per 1000 sq. ft. of net area should not be less than:	Contents of this bag should not cover more than:
R-30	13¾ in. thick	0.768 lbs. per sq. ft.	30	33 sq. ft.
R-22	10 in. thick	0.558 lbs. per sq. ft.	22	45 sq. ft.
R-19	8¾ in. thick	0.489 lbs. per sq. ft.	20	51 sq. ft.
R-11	5 in. thick	0.279 lbs. per sq. ft.	11	90 sq. ft.

Weight contents: not less than 24 lbs.

R-values are determined in accordance with ASTM C-687 and C-236

Fig. 12

REFLECTIVE INSULATION

Reflective insulation is composed of aluminum foil in one or more layers either plain or laminated to one or both sides of kraft paper for structural strength. The insulation value for reflective air spaces, which this type of insulation provides, varies widely depending on the direction of heat flow. They are much more efficient when the heat flow is *down*. Reflective insulations which comply with the requirements when used in a floor, may not be satisfactory in ceilings or walls, where the heat flow is

upward and horizontal, respectively. Reflective insulations are effective in controlling radiant heat energy when installed so that they face an air space. Insulation should be installed in such a manner that it is continuous, without holes or tears.

SPRAYED INSULATION

There are several types of insulation which are sprayed against the surface of the building materials or in cavities. Some of these are cellulose with binder, mineral wool with binder, and cellular foams. They may be sprayed directly on concrete, masonry, wood, plastic, or metal panels or may be sprayed between the framing members. Manufacturer's recommended instructions should be followed. To determine that the proper thickness is installed, either refer to the plans and specifications, or request a certification from the supplier that the insulation installed provides the required "R" value.

TYPICAL INSULATION THICKNESSES AND VALUES

<u>Insulation</u>	Approximate	
	<u>R-Value</u>	<u>Thickness</u>
Fiber glass	11	3½"
Fiber glass	13	3¾"
Fiber glass	19	6"
Fiber glass	30	8"
Fiber glass	38	12"
Extruded Polystyrene Foam	5.4	1"
Extruded Polystyrene Foam	10.8	2"

VAPOR BARRIERS

Vapor barriers are used in conjunction with insulation to decrease the chance of moisture condensation inside the building insulation. Vapor barriers are placed on the side of the wall, ceiling or floor that is warm in winter. For equal vapor pressures, moisture vapor penetration through holes or tears in the insulation vapor barrier is proportional to the size of the opening. Holes or tears should be repaired. A snug fit of blanket flanges against the framing is necessary to prevent moisture from bypassing the vapor barrier.

EQUIPMENT

The installation of the heating system can contribute to inefficiencies. A furnace which is oversized by a factor of 2 will require 8 to 10% more fuel than a furnace of correct size. An installation that has uninsulated ducts passing through an unheated crawl or attic space will lose about 1.5 Btu per hour per square foot of duct per degree of temperature differential between duct air and outside air. This can amount to 40% of a furnace output under mild conditions. Undersized ducting will reduce the amount of circulating air and will affect the capacity of the furnace, but will normally have little effect upon its efficiency. Atmospheric combustion equipment that draws its combustion and stack-dilution air from the heated space will require up to 8% more fuel in a season to heat the required makeup air than sealed combustion equipment. Stack heat recovery devices can recover from about 4% at 450° F to 8% at 800° F.

The appliance manufacturer should be consulted when retrofitting the appliance with combustion air to assure that the appliance warranty is not affected.

Effect of Sizing Limitation on Equipment

Using the example on system design illustrated in Appendix A, an analysis was made to see what impact or problem the proposal for limiting the size of equipment to 15% above the design losses would have.

Example:

Total construction loss	27,760 Btu/hour
One air change per hour:	
Inside volume = 12,188 cu. ft.	
$Q = (12,188) (90) (.018) = 19,744$ Btu/hour	
Total infiltration loss	<u>19,744 Btu/hour</u>
	47,504 Btu/hour

Maximum furnace size:

$$47,504 \text{ Btu/hour} + 47,504 (.15) \text{ Btu/hour} = 54,630 \text{ Btu/hour}$$

COMBUSTION AIR FOR FIREPLACES

It is recommended that combustion air from the exterior be provided for all fireplaces. Masonry fireplaces can be made more energy efficient with combustion air terminating in the fireplace. The opening of the fireplace should be equipped with a door and the combustion air duct with a damper and a louver to minimize air leakage during periods of nonuse.

CONDENSATION CONTROL

Air Infiltration

The department will accept infiltration losses determined by the air crack method or an overall value of 1/2 air change per hour.

The department will accept the use of engineered top-side moisture vent systems.

Relative Humidity

Winter: During the winter it is desirable to have humidity in the air in order to prevent the nostrils from becoming dry, furniture from cracking, etc. However, from an energy standpoint, it is desirable to keep the relative humidity low; the trade off is at about 30%.

Summer: During the summer it is desirable to reduce the level of relative humidity in the building in relationship to the outside relative humidity. The relative humidity should be kept as high as possible in order to conserve energy, but low enough for comfort. The relative humidity should be kept above 55%, but less than 60%.