

## **NOTICE OF PROPOSED GUIDANCE DOCUMENT**

DTIM-BPED35

Pursuant to Wis. Stat. s. 227.112, the Wisconsin Department of Transportation is hereby seeking comment on DTIM-BPED35, 23 CFR 109, a proposed guidance document.

### **PUBLIC COMMENTS AND DEADLINE FOR SUBMISSION**

Comments may be submitted to the Wisconsin Department of Transportation for 21 days by:

1. Department's website: <https://appengine.egov.com/apps/wi/dot/guidance-docs?guidDocId=DTIM-BPED35>

2. Mailing written comments to:

Division of Transportation Investment Management  
Wisconsin Department of Transportation  
4822 Madison Yards Way  
PO Box 7913  
Madison, WI 53707-7913

### **WEBSITE LOCATION OF FINAL GUIDANCE DOCUMENT**

The final version of this guidance document will be posted at [wisconsin.dot.gov](http://wisconsin.dot.gov) to allow for ongoing comment.

### **AGENCY CONTACT**

Kaleb Vander Wiele  
DOTDTIMGuidanceDocs@DOT.WI.GOV



Wisconsin Department of Transportation

# Transportation Planning Manual

## Table of Contents

### Chapter 9 Traffic Forecasting, Travel Demand Models and Planning Data

<b><u>SECTION 1 – General Forecasting Protocols and Procedures</u></b> .....	<b>3</b>
Subject 1 – Introduction and Purpose .....	4
Subject 2 – Reasons for Forecasts and Travel Analysis.....	5
Subject 3 – Roles and Responsibilities for WisDOT Forecasting .....	6
Subject 4 – WisDOT Roadway Traffic Forecasting .....	7
Subject 5 – Related Policies.....	17
<b><u>SECTION 10 – Forecasting in Travel Demand Model Areas</u></b> .....	<b>18</b>
Subject 1 – Introduction and Usage Areas.....	19
Subject 2 – Conditions for Use and Department Involvement.....	23
Subject 3 – Model Version Control .....	25
Subject 4 – Demand Model Roadway Forecast Techniques.....	30
Subject 5 – Travel Demand Models and TAFIS .....	35
Subject 6 – Travel Demand Models and Travel Simulation Models .....	39
Subject 7 – Related Policies.....	41
<b><u>SECTION 20 – Wisconsin Travel Demand Models</u></b> .....	<b>43</b>
Subject 1 – Wisconsin Travel Demand Models.....	44
Subject 2 – Model Nomenclature.....	46
<b><u>SECTION 30 – Traffic Analysis Forecasting Information System (TAFIS)</u></b> .....	<b>49</b>
Subject 1 – Introduction and Usage Area .....	50
Subject 2 – Roadway Traffic Forecasting using TAFIS .....	52
Subject 3 – Enterprise Data Updates.....	62
Subject 4 – Traffic Forecasts and Meta-Manager .....	65

Subject 5 – Manual Regressions for Traffic Forecasting.....	67
Subject 6 – Related Policies.....	68
<b><u>SECTION 40 – Data Elements of Roadway Traffic Forecasting</u></b> .....	<b>69</b>
Subject 1 – Introduction.....	70
Subject 2 – Estimating Vehicle Miles of Travel.....	71
Subject 3 – Geometric Design Factors.....	73
Subject 4 – Continuous Count Data and Adjustment Factors.....	78
Subject 5 – Truck Analysis for Traffic Forecasting.....	81
Subject 6 – Related Policies.....	83
<b><u>SECTION 50 – Traffic Impact Analysis (TIA)</u></b> .....	<b>84</b>
Subject 1 – TIA Forecasts.....	85
Subject 2 – TIA Review.....	93
Subject 3 – Wisconsin TIA Guidelines.....	94
Subject 4 – Related Policies.....	95
<b><u>SECTION 60 – Travel Surveys</u></b> .....	<b>96</b>
Subject 1 – Reasons for Collecting Data.....	97
Subject 2 – Related Policies.....	100
<b><u>SECTION 70 – Appendix</u></b> .....	<b>101</b>
Subject 1 – WisDOT Region Traffic Forecasting Contacts.....	102

## Traffic Forecasting, Travel Demand Models and Planning Data

### Section 1 – General Forecasting Protocols and Procedures

Subject No.	Subject Title	Effective Date
Section 1 (All Subjects)		
1.1	<a href="#">Introduction and Purpose</a>	May 2018
1.2	<a href="#">Reasons for Forecasts and Travel Analysis</a>	May 2018
1.3	<a href="#">Roles and Responsibilities for WisDOT Forecasting</a>	May 2018
1.4	<a href="#">WisDOT Roadway Traffic Forecasting</a>	May 2018
1.5	<a href="#">Related Section Policies</a>	May 2018



## **Transportation Planning Manual**

Wisconsin Department of Transportation

### **Chapter 9, Section 1 General Forecasting Protocols and Procedures**

#### **Subject 1 Introduction and Purpose**

## **1.1 Introduction and Purpose**

The Wisconsin Department of Transportation (WisDOT) has produced transportation forecasts and analyses for many years. WisDOT has refined its techniques, as well as developed policies and standardized procedures that have guided transportation analyses. Today, several sophisticated models and tools exist to forecast travel on Wisconsin's transportation system. *Chapter 9 - Traffic Forecasting, Travel Demand Models and other Planning Data* outlines WisDOT's forecasting process, from input assumptions to final output results.

This chapter formalizes and standardizes the process, requirements, and background information used to do traffic forecasting and multimodal travel projections in Wisconsin. It is also a reference for all parties who use traffic forecasts and travel demand estimation techniques in the corridor planning and project development processes. As noted in *National Cooperative Highway Research Program Report #765 Analytical Travel Forecasting Approaches for Project-Level Planning and Design*, forecasting guidelines are intended to standardize, guide and give a high-level understanding of techniques. The guidelines are used for the planning, design, and operation of highway system elements.

Updates to this chapter will be made on an ongoing, as-needed basis. The chapter will change as policy, procedures, and/or work processes change within the department. Questions, comments, and other concerns on *Chapter 9 - Traffic Forecasting, Travel Demand Models and other Planning Data* can be directed to:

Jennifer Murray  
Traffic Forecasting Section Chief  
Wisconsin Department of Transportation  
Phone: (608) 264-8722  
Fax: (608) 267-0294  
Email: [Jennifer.Murray@dot.wi.gov](mailto:Jennifer.Murray@dot.wi.gov)



## **1.2 Reasons for Forecasts and Travel Analysis**

Transportation forecasting is the process of estimating the number of people or vehicles that will use a specific transportation facility in the future. Transportation forecasts can be utilized in a variety of different situations and with different modes of transport, from estimating traffic volumes on a specific segment of road or highway, to estimating ships in a port, or passenger volumes on a city's buses.

Traffic forecasts help to explain what the needs of the future might be and provide benchmarks for proper design and efficient transportation system operation. Example applications of forecast information include:

- Development of infrastructure capacity and design calculations (e.g., the operations of an existing or proposed roadway or bridge, or the thickness or type of roadway pavements)
- Estimation of the financial and/or social viability of projects (e.g., developing benefit-cost analyses and/or social impact assessments)
- Calculation of environmental impacts, such as air and noise pollution

As noted in [Section 1, Subject 3](#), travel analysis and traffic forecasts occur and are important inputs in developing infrastructure – from guiding the department's overall transportation policy, to informing planning studies and the engineering design of specific projects. WisDOT's Traffic Forecasting Section provides expertise in:

- Highway traffic forecast assumption development and completion
- Regional travel demand and forecasting model development
- Travel and origin-destination survey implementation
- Vehicle miles of travel estimation
- Special studies and analysis
- Peak and design hour factor development
- Heavy truck classification estimation procedures



## **1.3 Roles and Responsibilities for WisDOT Forecasting**

- WisDOT's Traffic Forecasting Section
  - Is physically located in WisDOT's central office in Madison and is part of the Bureau of Planning and Economic Development (BPED) in the Division of Transportation Investment Management (DTIM)
  - Serves as the overall lead in forecasting travel and conducting future travel analysis on the state trunk highway system (see [FDM 4-1-5.1](#) for more information about the state trunk highway system)
  - Directs forecasting policies and implements travel analysis procedures, including highway traffic forecasts
  - Conducts overall review and final approval of all forecasts on the state trunk highway system
- WisDOT Region Planners and Project Development Engineers
  - Plan for, design, and manage roadway improvement projects for their respective region
- Metropolitan Planning Organizations (MPOs)
  - Perform transportation planning activities (including long-range plans) for Metropolitan Planning Areas (MPAs), in cooperation with WisDOT
  - May conduct analysis with travel demand models
  - May conduct traffic forecasts for projects
- Wisconsin Department of Natural Resources (DNR)
  - Works with WisDOT traffic forecasters and MPOs to demonstrate air quality conformity for the Environmental Protection Agency (EPA)

WisDOT traffic forecasting section expertise is utilized for all surface modes of travel. The section staff conducts overall review and final determination of approval of all forecasts. The section maintains a record of approved forecasts. To request a forecast review, use form [DT1594](#). To submit a forecast request, use form [DT1601](#).



## **1.4 WisDOT Roadway Traffic Forecasting**

WisDOT traffic forecast requirements for roadway projects follow applicable state laws and federal regulations. To satisfy the regulatory requirements as identified by 23 USC 109, 23 CFR 625, and pursuant to 40 CFR 1500.1(b), WisDOT follows the flow chart identified in [Table 1.4.1](#) and [Figure 1.4.1](#).

The National Highway System (NHS) designation, jurisdiction of the roadway, and the project improvement type help determine if a forecast is required and the type of forecast (planning-level or project-level) necessary. See <http://wisconsin.dot.gov/Pages/projects/data-plan/plan-res/nhs.aspx> for maps and more information about the NHS. Forecasts are required for all projects if an Environmental Impact Statement (EIS) or Environmental Assessment (EA) is being prepared. A Categorical Exclusion (CE) or Environmental Report (ER) project may not require a traffic forecast.

If the project is on the local road system, the local municipality is responsible for forecast development. The local road system consists of country trunk highways and other local city, village, or town roads not “on” the state trunk highway system. Local municipalities manage and own local roads (jurisdiction).



Table 1.4.1: WisDOT Traffic Forecasting Requirements

National Highway System	Project Location	Project Type <sup>1,2</sup>	Forecast Required	WisDOT Will Conduct or Review Forecast <sup>3</sup>	Type of WisDOT Forecast	
					Planning-Level (TAFIS)	Project-Level
NHS Route	State Trunk Highway System	Preservation	Yes	Yes	X	
		Non-Preservation	Yes	Yes		X
	Connecting Highway	Preservation	Yes	Yes	X	
		Non-Preservation	Yes	Yes		X
	Tied to a State Trunk Highway Project	Preservation	Yes	Yes	X	
		Non-Preservation	Yes	Yes		X
Local Road System (Jurisdiction)	Preservation or Non-Preservation	Yes	No			
Non-NHS Route	State Trunk Highway System	Preservation	No	No		
		Non-Preservation	Yes	Yes		X
	Connecting Highway	Preservation	No	No		
		Non-Preservation	Yes	Yes		X
	Tied to a State Trunk Highway Project	Preservation	No	No		
		Non-Preservation	Yes	Yes		X
Local Road System (Jurisdiction)	Preservation or Non-Preservation	No	No			

Notes:

<sup>1</sup>Preservation projects for the purposes of forecasting requirements include resurfacing, reconditioning, pavement replacement, roadway maintenance, and bridge rehabilitation. Note that preservation as defined here may not follow the detailed descriptions within the FDM.

<sup>2</sup>Non-preservation projects for the purposes of forecasting requirements include new construction, reconstruction, expansion, bridge replacement, Interchange Access Justification Report, Intersection Control Evaluation, Traffic Impact Analysis, and freeway/expressway designation.

<sup>3</sup>Local governments (counties, cities, villages, or townships) are responsible for forecasting on the local road system (23 USC 106 (c)(2)).

Project level forecasts are required for all projects which have an Environmental Impact Statement (EIS) or Environmental Assessment (EA). WisDOT will conduct or review the forecasts for those projects if they are on the State Trunk Network, on a Connecting Highway, or tied to a State Trunk Highway project.

Figure 1.4.1: How forecasting fits into the environmental process

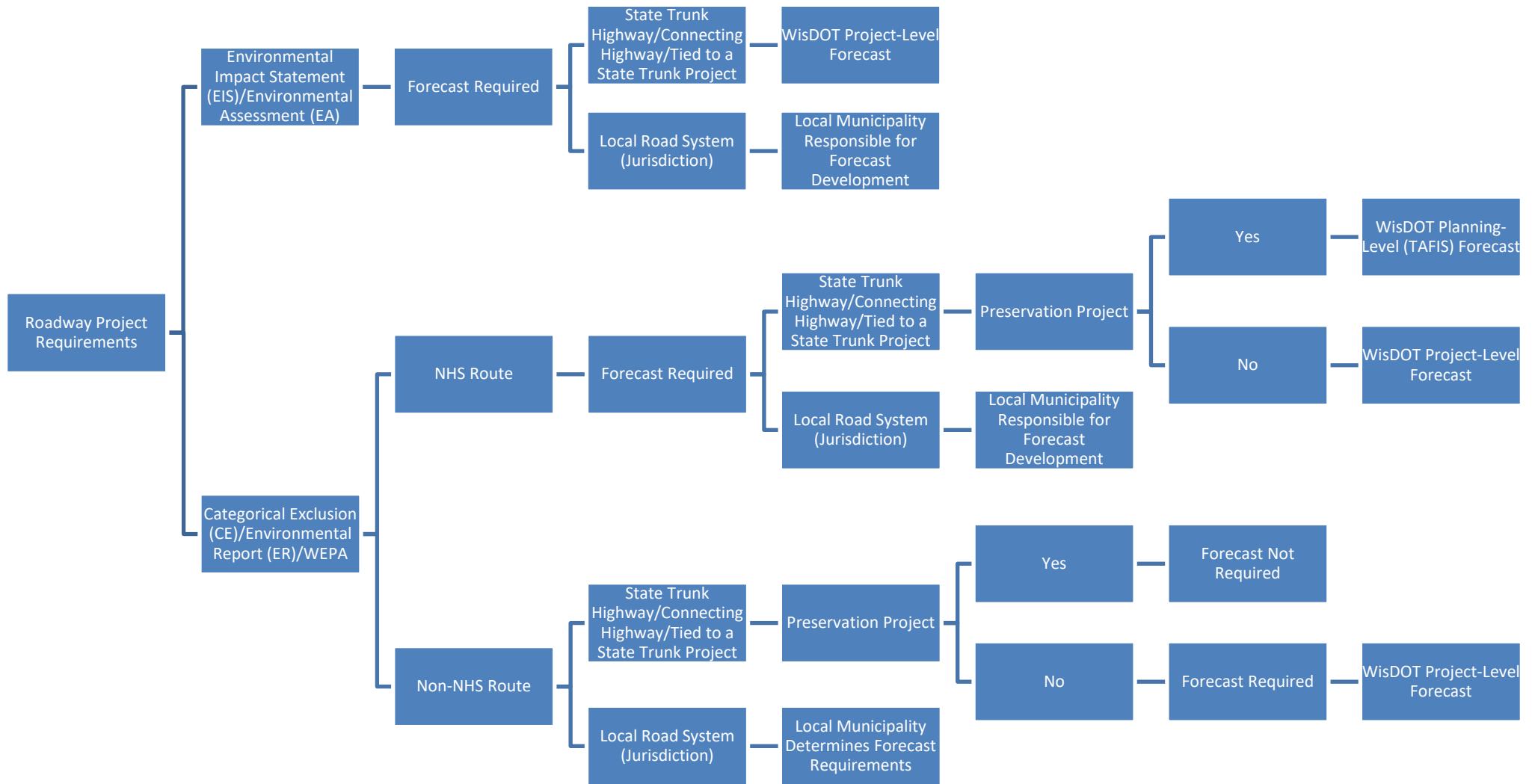

#### **1.4.a. Planning-Level Forecasts**

Planning-level forecasts consist of forecasts produced by the Traffic Analysis Forecasting Information System and are used in Meta-Manager for roadway improvement programming. The [DT1601](#) forecast request and delivery process is not part of planning-level forecast production.

Planning-level forecasts fulfill the requirements for preservation projects on the state trunk highway system and Connecting Highways that are a part of the National Highway System (NHS).

- Resurfacing
- Reconditioning
- Pavement replacement
- Roadway maintenance
- Bridge rehabilitation

Planning-level forecasts, vehicle classification data, and design values are posted to the WisDOT website for transportation project teams to gather necessary data here: <http://wisconsindot.gov/Pages/projects/data-plan/traf-fore/default.aspx>. For more information about TAFIS forecasts, see [Section 30](#).

#### **1.4.b. Project-Level Forecasts**

Project-level forecasts are produced using applicable WisDOT forecasting tools and models, and may include a mainline and/or turning movement forecast. Project-level forecasts are requested using form [DT1601](#). Reviews of project-level forecasts completed by other organizations (consultants and/or MPOs) are to be completed using the [DT1594](#) process.

Project-level forecasts are detailed analyses performed for non-preservation projects.

- New construction
- Reconstruction
- Expansion
- Bridge replacement
- Interchange Access Justification Report (IAJR)
- Intersection Control Evaluation (ICE)
- Traffic Impact Analysis (TIA)

- Freeway/expressway designation
- Projects with an Environmental Impact Statement (EIS) or Environmental Assessment (EA)

See [Section 1.4.f](#), for more information about the types of project-level forecast deliverables.

## **NHS Routes**

Forecasts are required for all projects on the NHS regardless of the source of funding. WisDOT will conduct or review traffic forecasts if the project is on the state trunk highway system, on a Connecting Highway, or tied to a state trunk highway project. Local municipalities develop and are responsible for NHS local road system forecasts.

### **1.4.c. Process**

WisDOT uses a standard, multi-step traffic forecasting process and procedure to develop roadway traffic forecasts. The necessity of a forecast is determined during project scoping. Scoping activities require one forecast for required projects. [WisDOT's FDM 3-1 Attachments 1.1 and 1.2](#) contain more information about the facilities development process. New data cannot be used until it is usable, analyzed, and has been integrated into WisDOT forecasting's tools. The WisDOT Bureau of Planning and Economic Development must make the preliminary determination that an updated forecast is required in consultation with the WisDOT Secretary's Office before an updated forecast (using new data) can be completed.

For projects which require a project-level forecast, project managers should request the forecast during project scoping. To request a traffic forecast, the requester must use WisDOT form [DT1601](#). The form encourages a team meeting between traffic forecasting, the Bureau of Traffic Operations, and the project team. All appropriate data and attachments (including potential development information) are to be included in the forecast request to ensure a timely delivery or review of the traffic forecast. The [DT1601](#) outlines work to be performed and is managed by the region contacts which are listed in [Table 70.1.1](#). Once the [DT1601](#) is completed, the region traffic forecasting contact submits it and related attachments to the Central Office Traffic Forecast Section Email: [DOTTrafficForecasting@dot.wi.gov](mailto:DOTTrafficForecasting@dot.wi.gov).

WisDOT's traffic forecasting section reviews and makes the final determination of approval of all forecasts (for more information on roles and responsibilities, see [Section 1, Subject 3](#)). To request a forecast review, the requester must use form [DT1594](#) and submit the form to the region contact listed in [Table 70.1.1](#). Sometimes consultants working for WisDOT complete portions of traffic analysis for plans or projects. In

these cases, efforts will be coordinated between the consultant staff and the traffic forecasting section. Consultants must submit forecasts for review and approval using the [DT1594](#) form.

#### **1.4.d. Traffic Counts**

WisDOT uses traffic counts or annual average daily traffic (AADT) as one of the main inputs to roadway forecasts. Traffic segment counts are taken on contiguous segments of the roadway network. WisDOT's enterprise database contains traffic segment counts for all existing state highway mainlines and many ramps. Forecasts will be conducted using traffic counts taken as part of the Bureau of State Highway Programs' (BSHP) normal count program. Contact BSHP, Data Management Section for more information on traffic count factoring or the statewide traffic count collection program. The request for new traffic counts or use of traffic counts from other sources in a forecast other than those traffic counts taken as part of the normal count program shall only be initiated by the Bureau of Planning and Economic Development, if approved by the WisDOT Division of Transportation Investment Management Administrator.

#### **1.4.e. Forecast Requests and Documentation**

As much information as possible should be included in the original forecast request regarding recent developments, newly constructed nearby local arterial/collector streets, and major business changes (expansions or contractions).

When a forecast is being conducted in a MPO area, the process and tools to develop the traffic forecast are essentially the same. Typically, a travel demand model and the Traffic Analysis Forecasting Information System (TAFIS) are used for travel behavior analysis. Sometimes, consultation with the MPO or local unit of government assists in data gathering and future planning activities and can have some effect on the forecasted output. See [Section 10. Subject 4](#) for more information on travel demand model forecast techniques.

After a forecast is completed, if there are concerns or questions, please contact the traffic forecaster. Assumptions must be documented during project-level forecasts and often include a forecast report, supporting workbooks, and references to forecasting methods/tools.

#### **1.4.f. Project-Level Forecast Deliverables**

Different types of roadway traffic forecasts are utilized in different situations to determine whether a future roadway should be planned for, designed, and built at a given location to accommodate future traffic volumes. Several types of roadway forecasts exist, including:

- Standard Design Year
- Roadway Build Scenario
- Land Use Build Scenario
- Traffic Impact Analysis (TIA) Base and Development

Roadway mainline (daily and peak forecasts) and roadway turning movement (daily and peak forecasts) may be completed for the various types of forecasts.

### Standard Design Year Forecasts

Standard design year forecasts (such as roadway mainline or turning movement forecasts) usually assume at least a 20-year projection into the future from estimated time of construction. Standard segment mainline forecasts are usually created with TAFIS and travel demand models (where available) and are the most basic type of forecast.

### Roadway Build Scenario Forecasts

A typical roadway build scenario forecast demonstrates the anticipated changes in traffic caused by new roadways or by existing facility modifications. Roadway build scenario forecasts are conceptually illustrated in Figure 1.4.2.

Figure 1.4.2: Conceptual changes in traffic over time

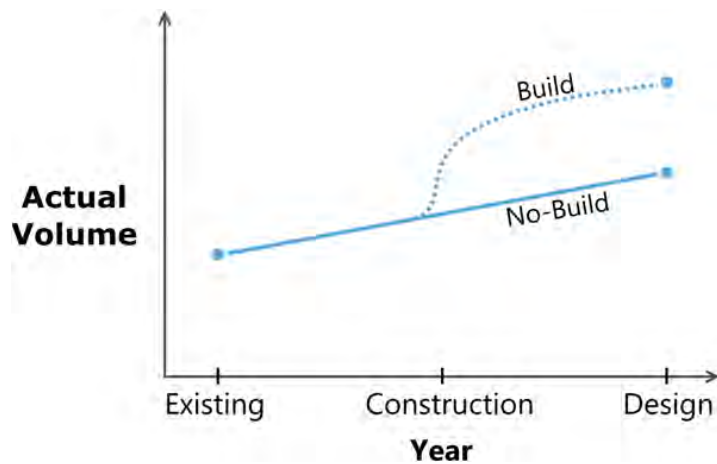

Roadway build scenario forecasts usually use the same 20-year projection as standard design-year forecasts. Roadway build scenario forecasts are produced by adjusting previously completed standard forecasts with the effects of changes in roadway geometry. Examples of these changes in assumptions that may be used

to develop a build forecast include, but are not limited to roadway network number of lanes, speed, access, and new alignments. Changes in assumptions or geometry are noted on the forecast report.

### **Land Use Build Scenarios**

Multiple socioeconomic data scenarios may be developed for a project. Because WisDOT does not develop or use land use models; close coordination with planning partners including MPOs, other local planning stakeholders, and/or third parties occurs. Coordination insures that planning outputs are linked to design and the operational activities of an area. The scenarios used in a forecast report (including data assumptions and socioeconomic data scenarios) are described in detail in each traffic forecast report workbook that is part of each project forecast.

### **Traffic Impact Analysis (TIA): Base Forecast and TIA Development Forecast**

[FDM 7-35-10.2](#) and the WisDOT Bureau of Traffic Operations' [Traffic Impact Analysis Guidelines](#) contain guidance on TIAs. Please see [Section 50](#) for more information on TIA forecasts.

### **Standard Approach to Project-Level Forecasts**

Regardless if it's a standard, model alternative, or TIA—WisDOT creates forecasts using a standard forecasting procedure. The Traffic Forecasting Section records official forecasts in a Central Office database. Documented assumptions, context, and model changes used in the analysis or for any forecast submittal often include:

- A standard forecast report showing base and future year traffic
- Traffic data, including peak hour volumes and truck percentages
- Traffic forecast assumptions
- Special procedures or trip generation techniques
- Changes made during the analysis, including changes to roadway carrying capacity tests
- Control total determination procedures and reasonableness tests

The following are examples of some of the forecasts completed by WisDOT's Traffic Forecasting Section.

# Roadway Mainline Daily Forecast

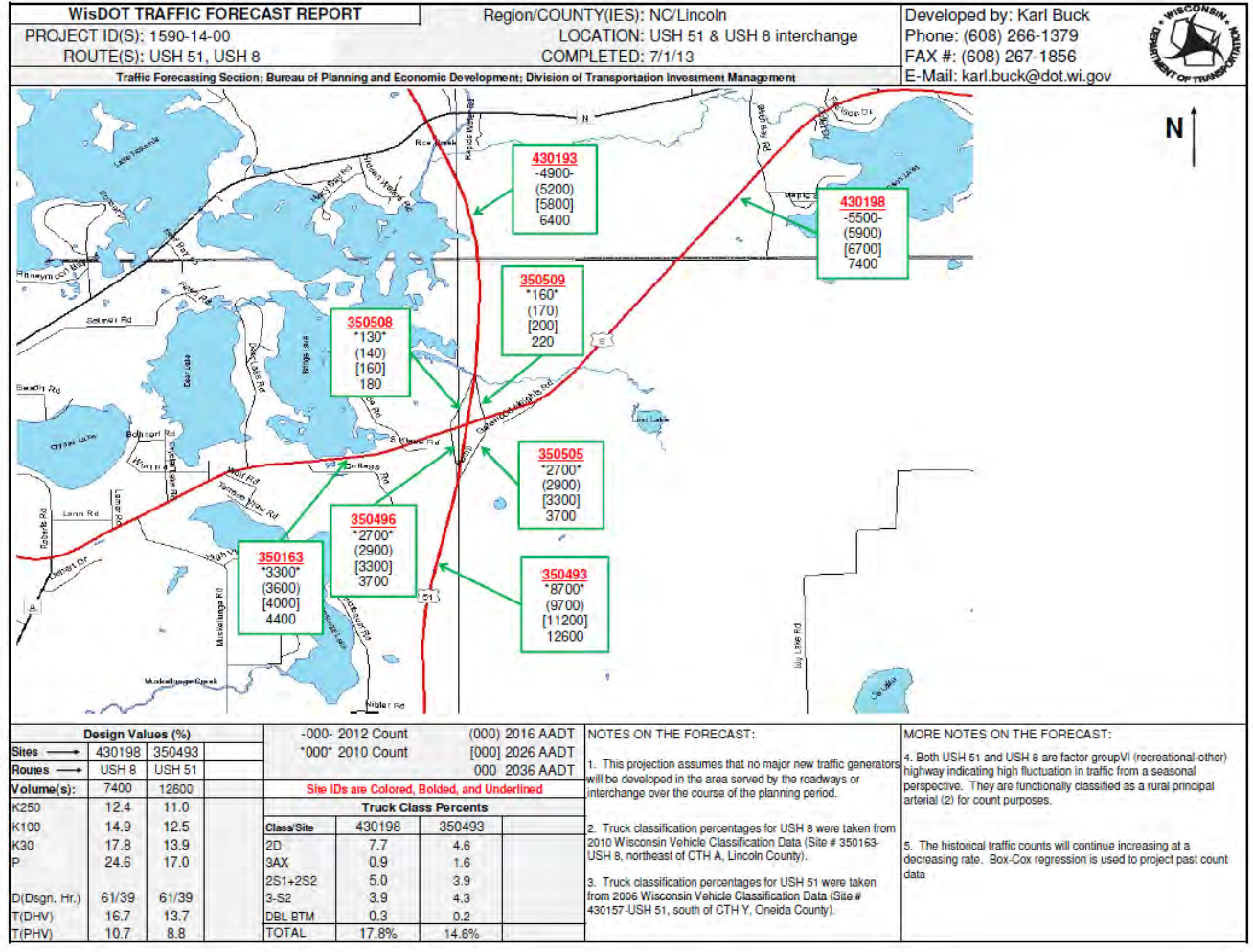



# Roadway Turning Movement Daily Forecast

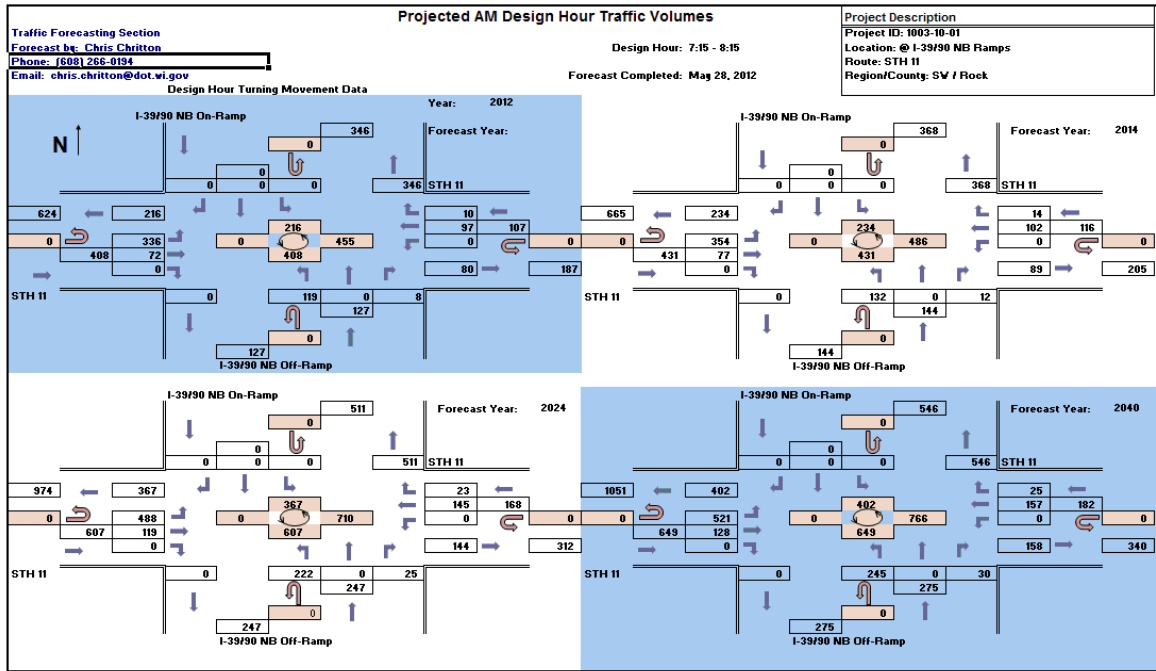



### **1.5 Related Policies: General Forecasting Protocols and Procedures**

It is WisDOT policy:

- To use a standard, multi-step traffic forecasting process and procedure to develop roadway traffic forecasts.
- To utilize the traffic forecasting expertise for all surface modes of travel.
- To require forecasts for projects on the National Highway System (NHS).
- To use planning-level forecasts for preservation projects on the state trunk highway system and Connecting Highways that are part of the NHS.
- To require project-level forecasts for non-preservation projects on the state trunk highway system.
- That local municipalities are responsible for forecast development for projects on the local road system.
- To require project-level forecasts if an Environmental Impact Statement (EIS) or Environmental Assessment (EA) is being prepared.
- That roadway traffic forecast requests ([DT1601](#)) are discussed, conducted, and reviewed by the traffic forecasting section; overall approval is by the traffic forecasting section using form [DT1594](#).
- That requests for traffic forecasts must be submitted using form [DT1601](#).
- That requests to review traffic forecasts done by others are submitted using form [DT1594](#).
- To maintain complete forecast records.
- To conduct forecasts using traffic counts taken as part of BSHP's normal count program.

**Traffic Forecasting, Travel Demand Models and Planning Data****Section 10 – Forecasting in Travel Demand Model Areas**

Subject No.	Subject Title	Effective Date
Section 10 (All Subjects)		
10.1	<a href="#">Introduction and Usage Areas</a>	May 2018
10.2	<a href="#">Conditions for Use and Department Involvement</a>	May 2018
10.3	<a href="#">Model Version Control</a>	September 2016
10.4	<a href="#">Demand Model Roadway Forecast Techniques</a>	May 2018
10.5	<a href="#">Travel Demand Models and the Traffic Analysis Forecasting Information System (TAFIS)</a>	May 2018
10.6	<a href="#">Travel Demand Models and Travel Simulation Models</a>	May 2018
10.7	<a href="#">Related Policies</a>	May 2018



## **10.1 Introduction and Usage Areas**

Travel demand models are sophisticated tools used to forecast future travel patterns. Current socio-economic data, roadway networks, trip rates, and other factors are used by the model to calculate the current and future travel patterns on a transportation system. Trip-making behavior analysis, completed utilizing the outputs from travel demand models, is input into long-range plans. Used with other planning tools, travel demand models can output a variety of data, including roadway traffic forecast information and deficiency characteristics.

### **10.1.a. Travel Demand Model Four-step Process**

Wisconsin's travel demand models are based on a classic four-step process that consists of:

- **Trip generation:** This step determines the frequency of origins and destinations of trips in each zone by trip purpose, typically as a function of household demographics and land uses, and other socio-economic factors.
- **Trip distribution:** This step pairs trip origins with destinations.
- **Mode choice:** This step calculates the proportion of trips between each origin and destination that use different transportation modes.
- **Traffic (route) assignment:** This step allocates trips between an origin and destination by a particular mode via different travel routes. Usually, route assignment is calculated under the assumption that each driver will choose the shortest travel time between origin and destination, subject to every other driver doing the same.

### **10.1.b. Metropolitan Planning Organizations and other Usage Areas**

Fourteen MPOs exist in Wisconsin. These MPOs are responsible for transportation planning and programming activities in metropolitan areas that have 50,000 or more people. MPOs prepare long-range transportation plans, which discuss transportation analysis and may include traffic forecasts with at least a

20-year planning horizon. WisDOT coordinates with the MPOs to develop and maintain travel demand models as part of this process. This also supports a comprehensive approach to local, regional, and state transportation planning.

See [Figure 10.1.1](#) for metropolitan planning areas and model locations. Chippewa-Eau Claire, La Crosse, and Dubuque have models that mirror the metropolitan planning area. Wausau, Janesville, and Beloit MPOs use travel demand models that mirror the boundaries in their respective counties rather than the smaller planning area boundaries. Madison utilizes a county-wide travel demand model, with the additional complexity of a mode-choice module. The MPOs located within WisDOT's Northeast and Southeast Regions maintain regional travel demand models that encompass multiple MPO areas.

Travel demand models also exist in the non-MPO areas of Stevens Point, Wisconsin Rapids, and St. Croix County.

Travel Demand Model and Metropolitan Planning Areas in Wisconsin  
August 2016



Figure 10.1.1: Travel demand models and Metropolitan Planning Areas in Wisconsin

Wisconsin's travel demand models contain geographies called transportation analysis zones (TAZs). Each travel demand model has a unique TAZ system that aggregates land use activity at a scale comparable to U.S. Census block groups. The land use summary for each TAZ is used in the trip generation step of the model to determine its productions and attractions. Trip distribution converts the zonal productions and attractions to origins and destinations, while mode choice determines the method (transit or automobile) each trip will take. Trips are then routed along the transportation system in the traffic (and/or transit) assignment step of the model. The Dane County Model, Southeast Wisconsin Regional Planning Commission Model, and the Northeast Region Model are currently the only Wisconsin models that include a full mode choice and transit assignment component. Mode choice is accounted for with auto occupancy rates by trip purpose where transit options are available.

Currently Wisconsin's travel demand models (except Dubuque, Duluth-Superior and the Southeast Region Planning Commission travel demand models) are coded with unique location identification codes that are integrated with WisDOT's traffic data processing software. This allows traffic counts and other inputs to be entered more easily, and outputs to be extracted and compared with other forecasting methods (especially TAFIS, as described in [Section 10, Subject 5](#)).

Travel demand models have been developed:

- Using Citilabs' Cube Voyager scripting platform to produce daily traffic forecasts
- Integrating National Household Travel Survey (NHTS) add-on data
- Using data gathered from the U.S. Census
- Using a traditional four-step model process
- Following MPO long-range plan update cycles

As stated in [Section 1, Subject 4](#), WisDOT's traffic forecasting section approves and stores a copy of all official roadway traffic forecasts in Wisconsin that the state has conducted or reviewed. WisDOT travel demand models provide input into the traffic forecast, including origin and destination trip tables that can be used for input into traffic micro-simulations. See [Section 1, Subject 4](#) for more information about roadway traffic forecasts.



### **10.2 Conditions for Model Use and Department Involvement**

Primary users of the travel demand models include consultants, MPOs, and WisDOT regional staff. The models are available for others to use as well.

#### **10.2.a. Conditions for Model Use**

WisDOT has identified standards and expected practices and procedures for model use. Those requesting release of MPO model data (termed, *the user*) from the department should understand the purpose and data in each model before using it.

These procedures are to be followed for every project and by every user, regardless of prior model usage or approval.

- A. The user of model data shall complete a [DT1599](#) form and submit the completed form to the department's traffic forecasting section. The contact is:

*Traffic Forecasting Section*  
*Wisconsin Department of Transportation*  
Email: [DOTTrafficForecasting@dot.wi.gov](mailto:DOTTrafficForecasting@dot.wi.gov)

- B. The model input data and associated files as well as materials and data developed from the model should not be applied by the user beyond the intended use and agreed-upon terms in the [DT1599](#) form.
- C. Users of the model must obtain and maintain their own licensed copy of the platform software (i.e., CUBE Voyager).
- D. The user shall not distribute the model or any files associated with the model to anyone outside the department, unless authorized by the department's traffic forecasting section.
- E. If the model socio-economic data needs to be amended or updated by the user, a written authorization must be obtained from the traffic forecasting section who will consult with the applicable MPO.



- F. Upon completion of its intended use, the user will agree to terminate the usage of the model(s) and all associated information and files unless other arrangements are agreed to by the department's traffic forecasting section.
- G. Upon completion of the project, the user agrees to provide copies of the final model files for the department and MPO records. This includes, but is not limited to:
  - a. All input files
  - b. Executables
  - c. Output files
- H. The user agrees to deliver the items listed in Part G in the same file format obtained from the department or as specified by the department's traffic forecasting section.
- I. The user agrees to provide a document identifying all files edited and a description detailing how and why the files were modified.
- J. The department accepts no responsibility for the results of the model application and/or model data maintained by the user.
- K. Cooperation with the department is required throughout the course of a project.
- L. If a model changes (see [Section 10, Subject 3](#)), model files and elements will be transmitted to the department or vice-versa along with any pertinent documentation. Any model updates shall be consistent with the standardized model nomenclature outlined in [Section 20, Subject 2](#), unless previously authorized by the department.

### **10.2.b Department Involvement**

Valid assumptions lead to credible forecasts. WisDOT's Traffic Forecasting Section requests project milestone meetings, as applicable and as indicated in Part K. The traffic forecasting section leads interim reviews and directs model application procedures. See [Section 10, Subject 4](#) for more information.

The Traffic Forecasting Section conducts overall review and final determination of approval of all WisDOT initiated forecasts. Any forecasts completed using the travel demand models or their outputs, without following the procedures outlined above, will not be considered for approval. Please see [Section 1, Subject 3](#) for more information regarding roles and responsibilities during the traffic forecasting process.



## **Transportation Planning Manual**

*Wisconsin Department of Transportation*

**Chapter 9, Section 10**

**Forecasting in Travel Demand Model Areas**

**Subject 3**

**Model Version Control**

### **10.3 Model Version Control**

WisDOT's Traffic Forecasting Section is responsible for model version control on the travel demand models. The forecasting section houses and maintains the latest travel demand models. The department works closely with each MPO to develop and maintain each MPO's regional travel demand model. The traffic forecasting section manages and approves all changes to the travel demand models in Wisconsin, except for Dubuque, Duluth-Superior, and the Southeast Regional Planning Commission travel demand models. All model requests and submittals should be made to the department. Coordinate all usage of the travel demand models with WisDOT traffic forecasting section as outlined in [Section 10, Subject 2](#). Ongoing involvement from the MPOs on a variety of issues occurs.

#### **10.3.a. Model Documentation**

Travel demand models can change. Documenting the changes that have been made helps to eliminate confusion and increases user confidence in model results. Documentation is kept in a library of model updates at WisDOT's Central Office Traffic Forecasting Section. Documentation occurs in three general areas, highway/transit, land use and model parameters. Documentation should clearly identify model version and the date the model was received from WisDOT and/or the MPO. WisDOT traffic forecasting will allow the use of graphics (i.e. area type, travel lanes, etc.) to support documentation of the model changes.

##### **10.3.a.i. Network Updates**

The transportation system should be accurately represented in the regional travel demand models. At a minimum, the transportation system should represent the system's existing conditions. Committed projects in the model represent projects that have been approved and have the funding for implementation. MPOs are federally required to update their transportation improvement program (TIP) yearly and provide a coordinated listing of the short-range transportation improvement projects anticipated to be undertaken

within a five year time horizon. These are the committed projects. Project prioritization often occurs during TIP development.

Planned projects in the model are defined as projects that do not have approval or funding for implementation. The TIP can be used to determine the status of anticipated projects and for classification as committed or planned within the model. The planned transportation system should be consistent with the long-term vision outlined in the MPO's long-range transportation plan, if the travel demand model is within an MPO planning area. Additional projects can be added and tested on a project-by-project basis to develop traffic forecasts and are often referred to as transportation alternatives. When conducting traffic forecasts, usually forecasts are developed for an MPO's *Existing plus Committed (E+C)* network, but not for an MPO's *Existing plus Committed plus Planned (E+C+P)* network.

WisDOT's Traffic Forecasting approves changes to the network, after consultation with the region and the MPO. Input from local stakeholders is recommended, but not required. Documentation should reflect the inherent uncertainty of travel behaviors and decisions over time and the impact they can have on forecasts developed using the travel demand models.

Documentation of updates to the highway network should include, but is not limited to, the following:

- Addition or removal of roadway facilities
- Functional classification updates
- Travel lane updates
- User-speed overrides
- Newly committed and/or planned projects

### **10.3.a.ii. Land Use Updates**

Land use assumptions developed for the MPO travel demand models are dynamic and continuously changing. Proper representation of the land use assumptions play a critical role in the model development and application. At a minimum, any changes to land use shall represent consistency with the local comprehensive plan. Employment, population, and/or housing numbers are often used as control totals in the travel demand modeling process. Municipal control totals shall be consistent with the local comprehensive plan and/or with data published by the Wisconsin Department of Administration's Center for Demographic Services.

WisDOT's Traffic Forecasting Section approves land use changes in cooperation with the region and MPO staff. Often, better land use estimation occurs with local stakeholder input. Document land use changes to better recognize how the changes affect long-range socio-economic forecasts. Changes to the model land use data will ultimately change traffic forecasts.

Document land use changes clearly. Submit a table of existing and updated land use assumptions to WisDOT's Traffic Forecasting Section when they have occurred. Document zonal adjustments or expansions with an illustration to better represent changes for traffic forecasting section approval.

Documentation of updates to the land use should include but is not limited to the following:

- Addition or expansion of zonal system (graphic required)
- Control total updates
- Household, employment or school enrollment updates
- Special generator updates or additions

### **10.3.a.iii. Transit Network Updates**

Proper representation of transit routes and assumptions play a critical role in the development of ridership forecasts. At a minimum, transit updates shall be consistent with the latest service planning assumptions and be consistent with the plans developed by the appropriate transit agencies.

WisDOT traffic forecasting approves transit system updates with assistance and cooperation from the region, MPO, and input from local stakeholders. Documentation of model changes should reflect the inherent uncertainty of long range transit forecasts. Key uncertainties include these factors—transit accessibility, competing services, regional development assumptions, mode bias, and transit fares, all of which can impact forecasts developed using the travel demand models.

Documentation of updates to the transit network should include but is not limited to the following:

- Addition or removal of transit routes
- Mode
- Run time (i.e. service hours and bus speed)
- Headway

- Future service improvements

#### **10.3.a.iv. Trip Generation and Distribution Updates**

Calibrated model parameters represent estimated travel behaviors and choices in a mathematical context. Adjustments to model parameters should be completed in direct accordance with and submitted to WisDOT Traffic Forecasting Section due to the large impact they have on the model outputs. Submit tables providing the existing and updated model parameters. If model parameters are determined to have a significant impact on regional travel behaviors, a validation report must be submitted consistent with [Section 10, Subject 3.b.](#)

Documentation of updates to model parameters should include but is not limited to the following:

- Trip generation rates
- K-factors
- Friction factors
- Mode-choice coefficients
- Auto-occupancy rates
- Time of day factors
- Volume/delay coefficients

#### **10.3.b. Validation Reports<sup>1</sup>**

Model validation refers to the application of a calibrated base year travel demand model, and the corresponding comparison between modeled results to observed data. A review of validation criteria enables a travel demand model user to determine if the model is performing at a level that produces appropriate results. The model should replicate observed travel behaviors without adversely affecting the ability to forecast the transportation project alternatives' attributes or characteristics. Well-documented validation results provide travel demand modelers with information necessary to determine the amount of confidence that can be placed in the model outputs. WisDOT's Traffic Forecasting Section expects model-wide or project-level basis documentation. An overview of updates and a corresponding validation report

---

<sup>1</sup> Model validation procedures rely heavily on information provided in the Travel Model Improvement Program (TMIP): *Travel Model Validation and Reasonableness Checking Manual*.

must be provided to WisDOT's Traffic Forecasting Section to establish benchmarks for model performance.

In project documentation, fully disclose updates to regional, corridor, and site level corridor plans or projects and provide a summary of the validation reports produced after running the regional travel demand model. Establish and explain the difference between the baseline (existing) and updated model. When counterintuitive results are reported, provide an explanation of them.

Validation reports should include but are not limited to the following:

- Average daily traffic summary
- GEH summary
- Root mean square error report
- Screenline report
- Model AADT to observed AADT
- Ridership to on-board survey for transit, if applicable

Contact WisDOT's Traffic Forecasting Section for more information on validation reports. Validated base year models ensure the model is able to reasonably reflect future year conditions. Validation of a base year model does not, in itself, ensure the reasonability of the future year forecasts. The validation process compares phases and aids in the development of credible forecasts. The process may differ slightly on a project-by-project or transportation mode basis. Document all methods and procedures and verify with WisDOT's Traffic Forecasting Section procedures to ensure consistency across the state.

### **10.3.c. Forecast Documentation**

When completing a traffic forecast, WisDOT's Traffic Forecasting Section requires documentation of travel demand model input and output changes, that may have occurred, as well as any other procedures deviating from normal practices or procedures. To understand how to develop a forecast with travel demand model data, please see [Section 10, Subject 4](#). All forecasts created using Wisconsin's travel demand models must be approved by the traffic forecasting section.



## **10.4 Demand Model Roadway Forecast Techniques**

Travel demand models are a useful tool in traffic forecasting, particularly in alternatives analysis forecasting and in forecasting growth based on specific socioeconomic factors. Utilized for a wide range of projects, ranging from statewide forecasts to sub-area studies involving micro-simulation models, travel demand models require initial confidence in data assumptions and careful interpretation of model outputs. Several steps are involved in generating a model output. These include and are not limited to:

- Reviewing model assumptions
- Changing attributes and revalidating the model (if applicable)
- Adjusting the assignments for forecast development
- Adjusting roadway link growth rates
- Finalizing the roadway traffic forecast

Travel demand model and TAFIS processes, steps, and assumptions to support logical forecast outputs are documented.

### **10.4.a. Reviewing Model Assumptions**

Roadway traffic forecasts are generally created the same way, regardless of the scale of the model. To be valid across forecast types, model assumptions should be reviewed. At the regional, corridor, site, or the long-range plan levels, several attributes should be reviewed before forecast development. The base year is defined as the year all data has been collected and usually corresponds to decennial U.S. Census data collection year—2000, 2010, 2020, etc. The future year is usually the travel demand model forecast year that corresponds with the MPOs long-range plan horizon year. The following attributes should be reviewed:

- Traffic analysis zones
  - Base and future year employees per zone

- Base and future year houses or population per zone
- Centroid connections
- Base and future year transportation network assumptions
  - Functional classification
  - Speed, including travel-time estimations
  - Roadway network capacity
  - Roadway network lanes
  - Operational characteristic review
    - Connectivity with other roadways
    - Surrounding roadway characteristics of influence
- Existing projects, future year STIP and TIP committed projects and planned MPO projects

In addition to the above, at the corridor and site planning levels, travel demand models require a review of the following at a minimum:

- Future year local comprehensive plans or development plans
- Base and future year trip generation assumptions
- Base and future site-specific travel times or origin-destination pairings

During long-range plan development, all of the above mentioned items are reviewed in depth, and any changes must be made in accordance with [Section 10, Subject 3](#). WisDOT assists MPOs in updating models or producing model outputs as part of the long-range transportation plan updates. Each long-range plan update requires transportation network and socio-economic data (households and employment) review. MPO staffs are able to utilize travel demand models to evaluate urban growth and transportation investments to evaluate future improvements on a regional level.

If after reviewing model assumptions it is determined that no changes to the model are necessary, the analyst should determine the appropriate adjustment to be applied to the model assignment for forecast development. If it is determined that changes are needed to the model to continue forecast development, the analyst should change attributes and revalidate model.



#### **10.4.b. Changing Attributes and Revalidating Model (if applicable)**

When modifications are necessary to the travel demand models for roadway traffic forecast development, see [Section 10, Subject 3](#) for procedures. Once approval is granted from the traffic forecasting section, the forecast development can proceed.

#### **10.4.c. Adjusting Assignments for Forecast Development**

Because of the difficulty in calibrating and validating travel demand models, the raw traffic assignment, or traffic that is assigned to a roadway link, is often misrepresentative of the actual traffic volumes. This phenomenon is usually evident in the model's base year and can be tested by comparing the raw base year traffic assignment to the counts on corresponding road segments or travel demand model links.

Usually, a factor in a travel demand model can cause a raw roadway assignment value to be higher than the traffic count in the base year. This can also cause the future roadway traffic assignment to be high (over-assignment). Low traffic count assignment values can also affect model results, creating assignments that are lower than the corresponding counts (under-assignment). To account for the differences between assignments and roadway traffic counts in the base year, a set of methodologies was produced by the Transportation Research Board and published in the *National Cooperative Highway Research Program Report #255 Highway Traffic Data for Urbanized Area Project Planning and Design*. The methodologies in this report set a standard for adjusting the raw future year roadway traffic assignments (or *raw* long-range plan horizon year traffic) based on the base year traffic assignment and count values. WisDOT follows standard, well-researched, nationwide protocols. Current methodologies are subject to review and/or replacement in light of the development of new standards.

The first method presented in the NCHRP report is called the difference adjustment method, which adjusts the future year assignment based on the absolute difference between the count and the base year assignment.

The equation is as follows:

Difference Adjustment:

$$\text{FORECAST} = (\text{COUNT} - \text{BASE ASSIGNMENT}) + \text{FUTURE ASSIGNMENT}$$

The difference adjustment method is primarily used for segments with low volumes (less than 10,000 AADT). Ideally, the roadway traffic count and base year traffic assignment should be the same number and the future year traffic assignment can then be used without much adjustment. This is because the travel demand model is accurately assigning roadway traffic in the base year (indicated by the assignment

matching the actual count). Also, it is assumed that the same traffic assignment pattern (over-assignment or under-assignment) will be present in both the base and future years. This assumption is explained more thoroughly in the NCHRP report on page 50.

The second method applicable to roadway traffic forecast production through travel demand models is called the ratio adjustment method, which adjusts the future year traffic assignment based on the ratio of the traffic count and base year traffic assignment. That equation is as follows:

Ratio Adjustment:

$$\text{FORECAST} = (\text{COUNT}/\text{BASE ASSIGNMENT}) \times \text{FUTURE ASSIGNMENT}$$

As with the difference adjustment method, the ratio adjustment uses the future assignment, if the base year assignment is exactly the same as the count. The ratio adjustment method can exaggerate the forecast in either direction when the base traffic assignment and traffic counts are very small [less than 10,000 annual average daily traffic (AADT)]. For example, in the model a base year count of 300 AADT and a base year assignment of 100 AADT exist. The future year traffic assignment is 1,000 AADT producing a forecast value of 3,000 AADT using the ratio adjustment method. Conversely, the difference adjustment method would produce a forecast value of 1,200 AADT because the traffic count, while proportionally much higher than the base assignment, is really very close in absolute terms. Travel demand models tend to be weaker (harder to calibrate and validate) on roadway links with low traffic volumes. When low traffic volumes exist on roadway links, the difference adjustment method is used as the preferred method, if it is still a valid methodology at low volumes. The ratio adjustment method can be useful in combination with the difference adjustment method. The average of the difference and ratio adjustment combination equation is as follows:

Average of Difference and Ratio Adjustment:

$$\text{FORECAST} = (\text{DIFFERENCE FORECAST} + \text{RATIO FORECAST}) / 2$$

WisDOT uses the best methodology for each individual roadway traffic forecasting situation based on recommendations of analysis of the equations from the NCHRP report. In most cases, the average of the ratio and difference methods is used. However, there are instances where one of the methods may not be appropriate. When the travel demand model future assignment is less than the base assignment (in a no-build forecast), the ratio method is suggested due to the potential for a forecasted volume of less than zero. In a situation where the ratio method might yield excessively high values, the difference method is suggested. The method selected is documented in the forecast report. The most important aspect in using a

methodology is that it, and its output, makes sense. If the outputs from one methodology do not make sense, using another equation is acceptable. WisDOT applies or chooses a roadway link annual growth rate in a no-build forecast of no less than 0 percent. Exceptions to this policy are noted in the forecast report. Analytical judgment is also used to determine if the applied growth rate makes sense.

#### **10.4.d. Adjusting Roadway Link Growth Rates**

Further adjustments to the model output traffic forecast value are required when the base year traffic count is not the most recent count on a roadway segment. The most recent traffic count is the most valuable piece of information in traffic forecasting and is the starting line representing the future year traffic. A new traffic count that is higher than previous traffic counts will shift a forecast up and a new traffic count that is lower will shift a forecast down. In travel demand model areas, the growth rate on the roadway link is calculated with the following equation:

$$\text{GROWTH RATE ON MODEL LINK} = ((\text{FORECAST VALUE} - \text{COUNT}) / \text{COUNT}) / (\text{FORECAST YEAR} - \text{COUNT YEAR})$$

The slope of the future year traffic forecast line is based on the average annual growth rate present on the specific roadway link within the travel demand model. The average annual growth rate for the roadway link is then applied to the most recent traffic count to create the future year traffic forecast value. The traffic forecast value is then compared with TAFIS to generate a better reasonability to the forecast. See [Section 10, Subject 5](#) for more information about comparing model and TAFIS forecasts.



## **10.5 Travel Demand Models and TAFIS**

The Traffic Analysis Forecasting and Information System (TAFIS) is a computer program operating on the principle of projecting future state trunk highway traffic volumes using historic counts to create a best-fit, statistically significant projection. To understand the TAFIS methodologies, see [Section 30, Subject 2](#).

WisDOT analyzes TAFIS outputs to conduct or review roadway mainline traffic forecasts on state trunk highways where TAFIS exists. WisDOT analyzes TAFIS and travel demand model outputs to conduct or review roadway mainline traffic forecasts in areas where WisDOT maintains the travel demand model or receives the travel demand model data from a MPO. WisDOT may use TAFIS, among other tools, to review forecasts based on a travel demand model from an MPO or other entity. An MPO or other entity may consider historic trends to produce a forecast to be used by WisDOT. Traffic count information or other inputs considered may not directly be from the travel demand model or TAFIS. When this occurs, variables are documented. In all cases, WisDOT uses analytical judgement and reviews the reasonableness of the inputs, forecast data, and outputs provided by an MPO or other entity. WisDOT reviews MPO or other entity-provided traffic information for forecasts and documents the review in the appropriate location. The review is kept in an appropriate location for the analysis underway (i.e. project file, data analysis background information, TAFIS TDM Project-Level Forecast Workbook, etc.).

If applicable, based on the availability and quality of data, WisDOT compares travel demand model forecasted volumes with TAFIS forecasted volumes when conducting or reviewing a standard design year (no-build) roadway mainline traffic forecast. Before the comparison of TAFIS and travel demand model forecasted volumes takes place, the analyst should consider that travel demand model forecasts and TAFIS forecasts are generated with different information at their core. The travel demand model forecast can account for anticipated changes in households and employment in specific traffic analysis zone (TAZ) locations. Regression-based TAFIS forecasts are based on formulas that are applied to the past and current counts on that site, with little to no intelligence behind the assumption as to why those changes occur. As

noted in [Section 30, Subject 2](#), TAFIS does not take classification data or land use development into account.

TAFIS likely forecasts traffic most confidently where many historic traffic counts exist. As such, it may not be prudent to compare TAFIS forecasts to travel demand model forecasts if only a few historical counts exist at a site. The type of TAFIS model (see [Section 30, Subject 2.a.](#)) and degree of confidence in the TAFIS forecast should also be considered before comparing to the travel demand model. WisDOT verifies traffic counts as the formal traffic forecast report process begins. If traffic counts change more than plus or minus 20 percent, or are inconsistent across a corridor, a re-count or explanation may be requested to understand possible causes. The 20 percent threshold is based on potential limitations in traffic count equipment and daily and seasonal variations in traffic patterns.

Travel demand model outputs generally tend to forecast travel with more confidence than TAFIS in areas with relatively high rates of land development. This includes but is not limited to analysis where a new roadway is proposed; congestion is constraining existing capacity; or where surrounding land uses are rapidly developing, generating a high number of trips.

WisDOT uses available information (including the ability to compare TAFIS and travel demand model volumes) when determining a forecast value at a traffic count site. The reasoning behind the comparative data analysis has been based on WisDOT's experience<sup>2</sup> and on statistical modelling studies that show that trying to solve complex analytic questions can be more successful with comparative analysis (econometric modeling, for example).

Forecasts may be generated from TAFIS and a travel demand model where both tools have a high degree of confidence. The TAFIS TDM Project-Level Forecast Workbook contains a framework for selecting the final future volume and can be used to compare TAFIS and the travel demand model. The workbook collects and sorts data. Existing traffic count volumes, count years, and future forecasted traffic volumes from both TAFIS and the travel demand model are inserted into the workbook from their data sources. The workbook compares the TAFIS and travel demand model future volumes and suggests a traffic forecast volume based on the following criteria:

---

<sup>2</sup> Karl Buck and Mike Sillence. *A Review of the Accuracy of Wisconsin's Traffic Forecasting Tools*. WisDOT, November 2013.

- If the travel demand model future volume is within  $\pm 10\%$  (between 90%-110%) of the TAFIS future volume, the travel demand model future volume is suggested
- If the travel demand model future volume is NOT within  $\pm 10\%$  (less than 90% or higher than 110%) of the TAFIS future volume, but the average of the TAFIS and model future volumes is within  $\pm 10\%$  (between 90%-110%) of both the TAFIS and model volumes, the average of the TAFIS and travel demand model future volumes is suggested
- If both the travel demand model future volume and TAFIS/model average future volume are not within  $\pm 10\%$  (less than 90% or more than 110%) of the TAFIS future volume, professional judgment is used to determine an appropriate forecasted volume.

Figure 10.5.1 below depicts the framework for the suggested future forecasted traffic volume.

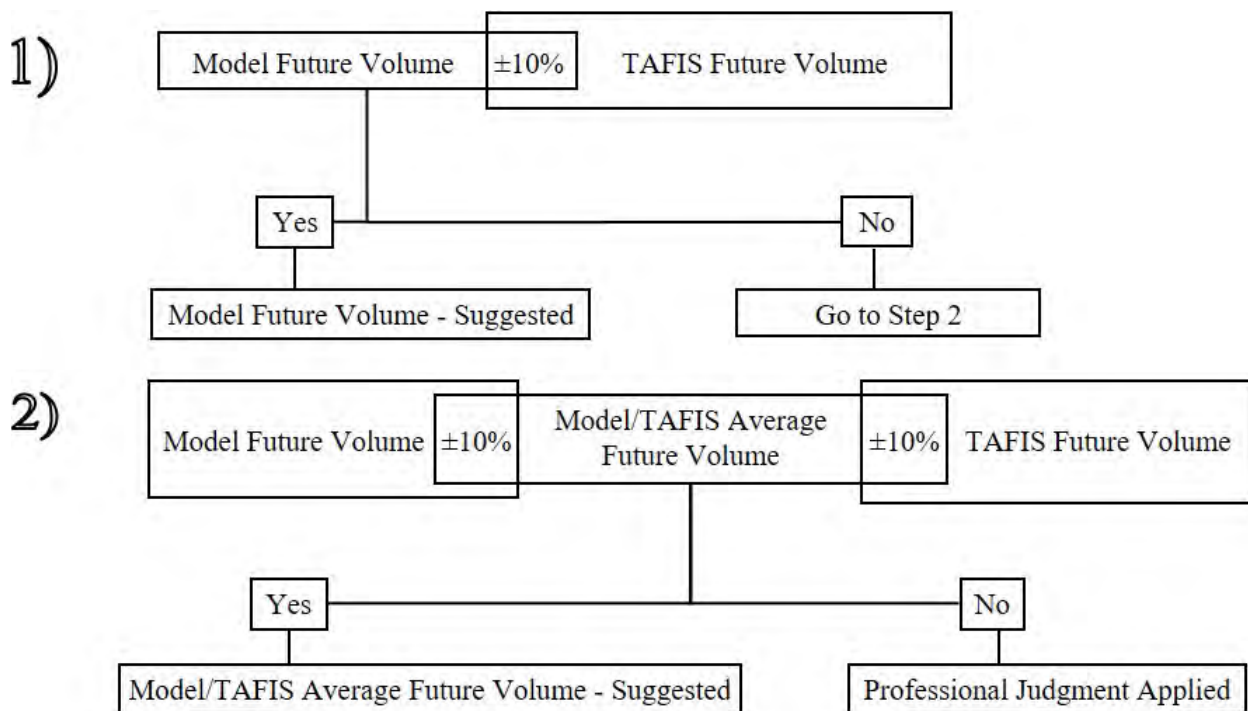

Figure 10.5.1: Framework for the Suggested Future Forecasted Volume

Because the availability and complexity of data varies among traffic count sites, and each count site and segment of roadway has unique characteristics, deviations from this framework may occur and are acceptable. WisDOT keeps a record of each forecast report developed. This record, including the TAFIS TDM Project-Level Forecast Workbook, contains specific information about inputs, forecasting protocols, and outputs; including comparisons (where applicable) of TAFIS and the travel demand model. Situations

where there may not be a high degree of confidence in comparing the results in this specific way are not limited to and may include:

- TAFIS forecasts with Southeast Wisconsin Regional Planning Commission travel demand model results in all locations in Southeast Wisconsin
- TAFIS forecasts with microsimulation models, turning movement or build forecasts
- TAFIS forecasts with the draft statewide travel demand model, travel demand models completed outside of the WisDOT modeling process or other types of subarea travel demand models
- TAFIS forecasts have a low degree of confidence due to a small number of historical traffic counts available or the type of TAFIS model

As mentioned earlier, deviations (manual overrides) from this comparative framework may occur and are acceptable. WisDOT uses professional judgment to determine the use of a manual override. Some things to consider when completing a manual override are the confidence level in the TAFIS forecast versus the travel demand model forecast. For example, if the TAFIS forecast was based on a county average annual traffic growth rate (also known as a “TAFIS Model 4.1”), one may want to place more emphasis on the travel demand model forecast. This is because the TAFIS forecast was based on a county average growth rate and not site-specific data. An override may also be supported by the careful assessment of the underlying traffic count data. If a manual override is completed, WisDOT will identify the reasoning and type of override completed and document it in the *Notes* column in the TAFIS TDM Project-Level Forecast Workbook. The workbook also contains all documented comparisons and professional judgement. Refer to [Section 30, Subject 2](#) for more information on roadway traffic forecasting using TAFIS.



## **10.6 Travel Demand Models and Roadway Simulation Models**

Traffic simulation models or *microsimulations* are real-time models showing the overall predicted flow of roadway traffic on a corridor. Accurate microsimulation models rely on component relationships and interactions between individual vehicles and roadway geometry, traffic congestion and traffic control. While simulation models are not a federally required analysis, they offer a sophisticated level of analysis at the roadway corridor level, for operations and traffic flow.

Sound statistics, reliable socioeconomic macro scale travel demand models, and dependable enterprise data help to create reasonable traffic volume forecasts. However, the effects of capacity upgrades, new access points to a roadway, and traffic diversion cannot be sufficiently modeled in most travel demand models. Similarly, travel demand models do not usually provide detailed information such as turning movement counts, user delay, and vehicle queuing for analysis purposes. Therefore, simulation programs have been developed to utilize traffic patterns derived from travel demand models. Simulation models can assist planners and engineers in determining measures of effectiveness of a transportation facility, such as levels of service, user delays, travel times, and queue lengths. See [FDM 11-5-3.7](#) and [Traffic Engineering, Operations, and Safety Manual \(TEOpS\) Section 16-20-4](#) for more information regarding traffic analysis tools and supported simulation programs.

Simulation programs typically rely on an extraction of the origin-destination data (O-D) from the travel demand models' trip tables to determine vehicular travel patterns, often within a subarea. Existing traffic operations data is then input into the simulation model to emulate observed traffic conditions. Simulation models are then run and their outputs are analyzed and calibrated to reflect reasonable traffic conditions.



### **10.6.a. Traffic Forecasting Section Review of Microsimulation Models**

Inform traffic forecasting when using microsimulation models. The traffic forecasting section reviews microsimulation models according to the [TEOpS Sections 16-25-1 and 16-25-2](#). The traffic forecasting sections documents the review using form [DT2340](#).



## **10.7 Related Section Policies**

A summary of the WisDOT policies that were discussed in this section are:

It's WisDOT policy:

- To collaborate and cooperate with MPOs to develop travel demand models following standard forecast development procedures.
- To document travel demand model and TAFIS processes, steps, and assumptions to support logical forecast outputs—including the comparison of traffic growth rates and other comparative data analysis as necessary.
- To ensure travel demand modeling practices follow standard, well-researched, nationwide protocols.
- To use the model data request form as a mechanism for those outside WisDOT to request travel demand model files.
- To ensure other parties who have made changes to the travel demand models, report those changes in a formal written email or correspondence.
- To maintain travel demand models in all travel demand model areas, except Dubuque, Duluth-Superior and Southeast Wisconsin Regional Planning Commission.
- To apply or choose a roadway link annual growth rate for a no-build forecast no less than 0 percent. Exceptions to this policy are documented.
- To use the traffic forecasting section to approve traffic forecasts on state trunk highways completed outside the department that use the travel demand models, or their outputs, only if the model sharing procedures have been adhered to, as outlined in [Section 10, Section 2](#).
- To analyze TAFIS outputs to conduct or review roadway traffic forecasts on state trunk highways where TAFIS exists.

- To analyze TAFIS and travel demand model outputs to conduct roadway mainline traffic forecasts in areas where WisDOT maintains the travel demand model or receives the travel demand model data from an MPO.
- To verify MPO or other entity-provided traffic information and document the review in the appropriate location (i.e. project files). WisDOT may use TAFIS, among other tools, to review travel demand model data or forecasts based on a travel demand model from an MPO or other entity.
- To inform the traffic forecasting section of the use of simulation software before work begins so procedures can be monitored and done correctly for the plan or project.
- To use the traffic forecasting section to review microsimulation models in coordination with the Bureau of Traffic Operations as outlined in the [Traffic Engineering, Operations, and Safety Manual \(TEOpS\) Sections 16-25-1 and 16-25-2.](#)
- To use form [DT2340](#) to document the traffic forecasting review of microsimulation models.

Traffic Forecasting, Travel Demand Models and Planning Data

Section 20 – Wisconsin Travel Demand Models

Subject No.	Subject Title	Effective Date
Section 20 (All Subjects)		
20.1	<a href="#">Wisconsin Travel Demand Models</a>	May 2018
20.2	<a href="#">Model Nomenclature</a>	May 2018



**Transportation Planning Manual**

Wisconsin Department of Transportation

**Chapter 9, Section 20**

**Wisconsin Travel Demand Models**

**Subject 1**

**Wisconsin Travel Demand Models**

**20.1 Wisconsin Travel Demand Models**

Table 20.1.1 below contains information about travel demand models in Wisconsin. For a map of travel demand model locations, see Figure 10.1.1. A list of contacts for each MPO is available here: <http://wisconsindot.gov/Documents/doing-bus/local-gov/plning-orgs/contacts.pdf>. Contact the traffic forecasting section with questions regarding travel demand models.

Table 20.1.1: Travel demand models in Wisconsin

Wisconsin Travel Demand Models								
Model Name	Maintained By	MPO(s)	Geography	Base Year	Future Year	Congestion Feedback Loop	Mode Choice	Time of Day
Southeast Regional Travel Demand Model	SEWRPC	Seven county southeastern Wisconsin area	Kenosha, Milwaukee, Ozaukee, Racine, Walworth, Washington, and Waukesha counties					
Northeast Regional Travel Demand Model	WisDOT	Fox Cities, Fond du Lac, Green Bay, Oshkosh, and Sheboygan	Brown, Calumet, Door, Fond du Lac, Kewaunee, Manitowoc, Outagamie, Sheboygan, Waupaca, Winnebago, and portions of Dodge, Oconto, and Shawano counties	2010	2045	Yes	Yes	Yes
Dane County Travel Demand Model	WisDOT	Madison	Dane County	2010	2050	Yes	Yes	Yes
Marathon County Travel Demand Model	WisDOT	Wausau	Marathon County	2010	2050	No	No	No

Rock County Travel Demand Model	WisDOT	Janesville, Beloit	Rock County	2010	2050	No	No	No
St. Croix County Travel Demand Model	WisDOT	None	St. Croix County	2010	2050	No	No	No
Eau Claire - Chippewa Falls Regional Travel Demand Model	WisDOT	Eau Claire	Metropolitan Planning Area in Eau Claire and Chippewa counties	2010	2045	No	No	No
La Crosse Regional Travel Demand Model	WisDOT	La Crosse	Metropolitan Planning Area in La Crosse County and La Crescent, MN	2010	2040	No	No	No
Stevens Point Travel Demand Model	WisDOT	None	Area around Stevens Point in Portage County	2010	2050	No	No	No
Wisconsin Rapids Travel Demand Model	WisDOT	None	Area around Wisconsin Rapids in Wood County	2010	2050	No	No	No
Duluth - Superior Regional Travel Demand Model	MIC	Duluth-Superior	Metropolitan Planning Area in Douglas (WI) and St. Louis (MN) counties					
Dubuque Regional Travel Demand Model	DMATS	Dubuque	Dubuque (IA), East Dubuque (IL), and a portion of Grant County (WI)					
Statewide Travel Demand Model*	WisDOT		State of Wisconsin	2010	2040	Yes	No	No

\*The statewide TDM has not been adopted for full use yet



## 20.2 Model Nomenclature

The purpose of this subject is to formalize and standardize the nomenclature used for the WisDOT maintained Wisconsin MPO models. Standardization of nomenclature throughout all MPO models reduces confusion and increases consistency. Consistent nomenclature enables users to be proficient and familiar with all Wisconsin MPO models. Standards are defined for both the land use inputs files and the highway network files.

### *TAZ Attributes*

TAZ attributes for the MPO models should be consistent throughout all models, in a manner that will allow users to accurately estimate land use activity within each zone. The zonal attributes in Table 20.2.1 below are currently in use for the MPO models and should continue as the standard zonal attributes to maintain consistency throughout the Wisconsin MPO models.

Table 20.2.1: Zonal attributes used in Wisconsin MPO models

Attribute	Description
ZONE	TAZ Number
HOUSEHOLDS	Occupied Households
RETAIL	Retail Sector Jobs
SERVICE	Service Sector Jobs
OTHER	Other Jobs
TOTEMP	Total Employment
SCHENR	School Enrollment

Listed below are thorough definitions for each zonal attribute used in the Wisconsin MPO models:

- Zone                                      Transportation Analysis Zone number
- Households                              Total occupied primary dwelling units, not including group quarters (US Census 2010)
- Retail Employment                      Total persons employed in the retail sector, NAICS 44-45 (US Census 2010, Wisconsin Department of Workforce Development, InfoUSA, Woods & Poole, aerial imagery, local plans/officials)

Service Employment	Total persons employed in the service sector, NAICS 51, 54, 56, 61, 62, 71, 72, 81 (US Census 2010, Wisconsin Department of Workforce Development, InfoUSA, Woods & Poole, aerial imagery, local plans/officials)
Other Employment	Total persons employed in sectors other than retail and service (US Census 2010, Wisconsin Department of Workforce Development, InfoUSA, Woods & Poole, aerial imagery, local plans/officials)
Total Employment	Total employment regardless of sector (US Census 2010, Wisconsin Department of Workforce Development, InfoUSA, Woods & Poole, aerial imagery, local plans/officials)
School Enrollment	Total K-12 school enrollment (Wisconsin Department of Public Instruction)

## Highway Network Attributes

Highway network attributes for the MPO models should be consistent throughout all models, in a manner that will allow users to apply a consistent set of assumptions to the transportation system. The highway network attributes in the tables below are currently being used in the MPO models and should continue as the standard input and output network attributes to maintain consistency throughout the Wisconsin MPO models.

Listed in Table 20.2.2 are thorough definitions for each input highway network attribute used in the Wisconsin MPO models:

**Table 20.2.2: Highway network attributes used in Wisconsin MPO models**

Attribute	Description	Attribute	Description
A	A-Node #	CHG_LANE	Change Lane
B	B-Node #	CHG_FC	Change Functional Class
NAME	Roadway Name	CHG_SIGNAL	Change Signal Type
LANES	Number of Lanes	CHG_CROSS	Change Cross Type
DISTANCE	Link Distance (Miles)	SUB_SYSTEM	WisDOT Backbone Class
LINKCLASS	Functional Classification	CHG_SUBSYST	Change WisDOT Backbone Class
COUNT	Traffic Count	CHG_AREA	Change Area Type
YEAR	Traffic Count Year	CHG_P_SPEED	Change Posted Speed
CROSS	Cross Type	PLAN_FC	Planned Functional Classification
SIGNAL	Signal Density Classification	PLAN_LANE	Planned Lanes
AREA	Area Type	PLAN_AREA	Planned Area Type
SCREENLINE	Model Screenline ID Number	PLAN_CROSS	Planned Cross Type
TAFIS	TAFIS ID Number (4-digit)	PLAN_SIGNAL	Planned Signal Type
USERSPEED	Manual Free-Flow Speed Override	PLAN_SUBSYS	Planned WisDOT Backbone Class
NEWLINK	New Network Link	PLAN_P_SPEE	Planned Posted Speed
Not used in the modeling process.			



Listed in Table 20.2.3 are thorough definitions for each output highway network attribute used in the Wisconsin MPO models<sup>3</sup>:

**Table 20.2.3: Definitions of highway network attributes used in Wisconsin MPO models**

<b>Attribute</b>	<b>Description</b>
COUNT	Traffic Count
B_LINKCLASS	Base Year Linkclass
B_LANES	Base Year Lanes
B_AREA	Base Year Area Type
B_CAPACITY	Base Year Daily Capacity
B_SPEED	Base Year Free Flow Speed
B_SUBSYS	Base Year WisDOT Backbone Class
B_CTIME	Base Year Congested Travel Time
B_CSPD	Base Year Congested Travel Speed
B_AUTO	Base Year Auto Volume
B_TRUCK	Base Year Truck Volume
B_TOTAL	Base Year Total Volume
B_GEH	Base Year GEH Statistic
B_LOS_P	Base Year Base Year Level of Service Primary
B_LOS_S	Base Year Base Year Level of Service Secondary
B_DEF_P	Base Year Base Year Deficiency Primary
B_DEF_S	Base Year Base Year Deficiency Secondary
F_LNKCLSS	Future Year Linkclass
F_LANES	Future Year Lanes
F_AREA	Future Year Area Type
F_CAPACITY	Future Year Daily Capacity
F_SPEED	Future Year Free Flow Speed
F_SUBSYS	Future Year WisDOT Backbone Class
F_CTIME	Future Year Congested Travel Time
F_CSPD	Future Year Congested Travel Speed
F_AUTO	Future Year Auto Volume
F_TRUCK	Future Year Truck Volume
F_TOTAL	Future Year Total Volume
AUTODIFF	Base - Future Auto Difference
TRUCKDIFF	Base - Future Truck Difference
TOTALDIFF	Base - Future Total Difference

---

<sup>3</sup> Output Network Attributes will differ for the Northeast Regional Model.

**Traffic Forecasting, Travel Demand Models and Planning Data****Section 30 – Traffic Analysis Forecasting Information System (TAFIS)**

Subject No.	Subject Title	Effective Date
Section 30 (All Subjects)		
30.1	<a href="#">Introduction and Usage Areas</a>	May 2018
30.2	<a href="#">Roadway Traffic Forecasting using TAFIS</a>	May 2018
30.3	<a href="#">Enterprise Data Updates</a>	May 2018
30.4	<a href="#">Traffic Forecasts and Meta-Manager</a>	May 2018
30.5	<a href="#">Manual Regressions for Traffic Forecasting</a>	May 2018
30.6	<a href="#">Related Policies</a>	May 2018



### **30.1 Introduction and Usage Areas**

Developed in 2001, the Traffic Analysis Forecasting Information System, or *TAFIS*, is an automated procedure and SAS®-based computer program that creates roadway traffic forecasts on Wisconsin's 11,800 miles of state trunk highway system. *TAFIS* operates on the principle of projecting future roadway traffic volumes using historic counts to create a best-fit, statistically significant projection. Wisconsin experienced steady and atypically high growth in vehicle miles traveled (VMT) in the 1980s and early 1990s. Since then, VMT in the state has increased at a slower rate. In accordance with moderate VMT growth over that time frame, *TAFIS* considers historical traffic counts with the last 20 years for developing forecasts. In addition to providing annual average daily traffic forecasts for 60 years into the future, *TAFIS* calculates estimates for K-factors and heavy truck percentages. WisDOT uses a combination of *TAFIS*, and the travel demand model output, to conduct roadway traffic forecasts in areas where travel demand models exist. See [Section 10, Subject 4](#) for roadway traffic forecasting procedures in locations where travel demand models exist. In areas of the state where no travel demand model exists, WisDOT uses *TAFIS* to conduct roadway traffic forecasts.

*TAFIS* is a systematic forecasting tool that:

- Provides a consistent methodology for developing roadway traffic forecasts
- Creates a systems level comparison, based on different forecasting analysts completing different forecasts
- Allows for continued responsiveness as data updates, such as new annual average daily traffic (AADT) count estimates, become available

In general, WisDOT does not project linearly into the future because linear growth rates would likely overshoot long-term travel trends. *TAFIS* uses a Box-Cox regression approach that creates projections that are increasing, but at a decreasing rate.

Box-Cox transformations define a general class of mathematical models, which include pure linear and log-linear models. Perhaps the main advantage of the Box-Cox transformation is its flexibility compared to other transformations, such as log transformations. Data transformations are typically used in regression analysis for four reasons, to:

- Satisfy regression analysis functions
- Create likeness between variables
- Improve fit between data and regressed line
- Better understand assumptions forming the line

Box-Cox transformations perform well for traffic forecasting and capture many basic assumptions of the regression analysis. The mathematical formula of the transformation is as follows:

$$W = (Y^{\lambda} - 1) / \lambda \quad \lambda \neq 0$$

$$W = \ln Y \quad \lambda = 0$$

The variable (Y) depends on lambda ( $\lambda$ ). When applied to a variable that increases over time, such as is typical for roadway traffic volumes, values of lambda ( $\lambda$ ) are best fit. (W) is then used, post transformation directly in the simple linear regression equation as shown below:

$$W = B_0 + B_1 X_1$$

TAFIS uses values of  $\lambda$  between 2.5 and 4.0 and chooses the most statistically significant value of lambda. The chosen value minimizes the sum of the squared errors in the regression, while still producing a positive growth rate.



### **30.2 Roadway Traffic Forecasting using TAFIS**

As previously discussed in [Section 30, Subject 1](#), TAFIS is a computerized tool that compiles historical traffic volumes and other data at a specific state trunk highway traffic count site and then performs a Box-Cox regression to forecast future traffic at that site. TAFIS produces forecasts for 60 years out into the future. WisDOT has programmed TAFIS as a series of prediction models that produce results based on data conditions at or surrounding each site. Five models exist; which are the:

- Box-Cox Model
- Location-to-Location Model
- Cook's D Statistic Model
- Average Historic Proportion Model
- Specific Growth Rate Model

Because TAFIS works primarily with traffic counts and traffic count variability, TAFIS functions as a robust statistical tool. However, TAFIS has limits. TAFIS does not take into account classification data or land use development.

#### **30.2.a. TAFIS Models**

Traffic count sites are linked to roadway segments in TAFIS analysis. TAFIS models are used to develop segment level traffic forecasts in areas of Wisconsin where no travel demand model exists. Where travel demand models exist, WisDOT uses a combination of TAFIS and the travel demand model output to conduct roadway traffic forecasts. See [Section 10, Subject 4](#) for procedures on forecasting in travel demand model locations.

## Box-Cox Model – TAFIS Model 1.1

In TAFIS Model 1.1, historical traffic counts (AADT values) are regressed for each site to see if each site's historical counts are a significant predictor of AADT. Processing TAFIS Model 1.1 requires that each site must have at least five historical counts that produce a statistically significant positive slope. The most statistically significant lambda result is chosen as the output forecast. The equation for the forecast is as follows:

FORECAST=ALPHA + (BETA x TRAFFICYEAR); /\*ADJUSTED BY LAMBDA \*/

The first step in testing count data in TAFIS occurs when the TAFIS program runs the Box-Cox Model – Model 1.1. The Box-Cox Model uses a traffic count site's history of five or more years, to plot a line. After modeling the historic trend, TAFIS produces a positive, statistically significant trend line; which is increasing at a decreasing rate.

On occasion, WisDOT may need to use the TAFIS TDM Project-Level Forecast Workbook to perform regressions on historical traffic counts. The workbook replicates the TAFIS Model 1.1 approach. One example for use of a manual regression is to incorporate traffic counts not yet included in TAFIS. See [Section 30, Subject 5](#) for more information about manual regressions for traffic forecasting.

Figure 30.2.1: TAFIS Model 1.1 Graphical Outputs at a Traffic Count Site in Richland County

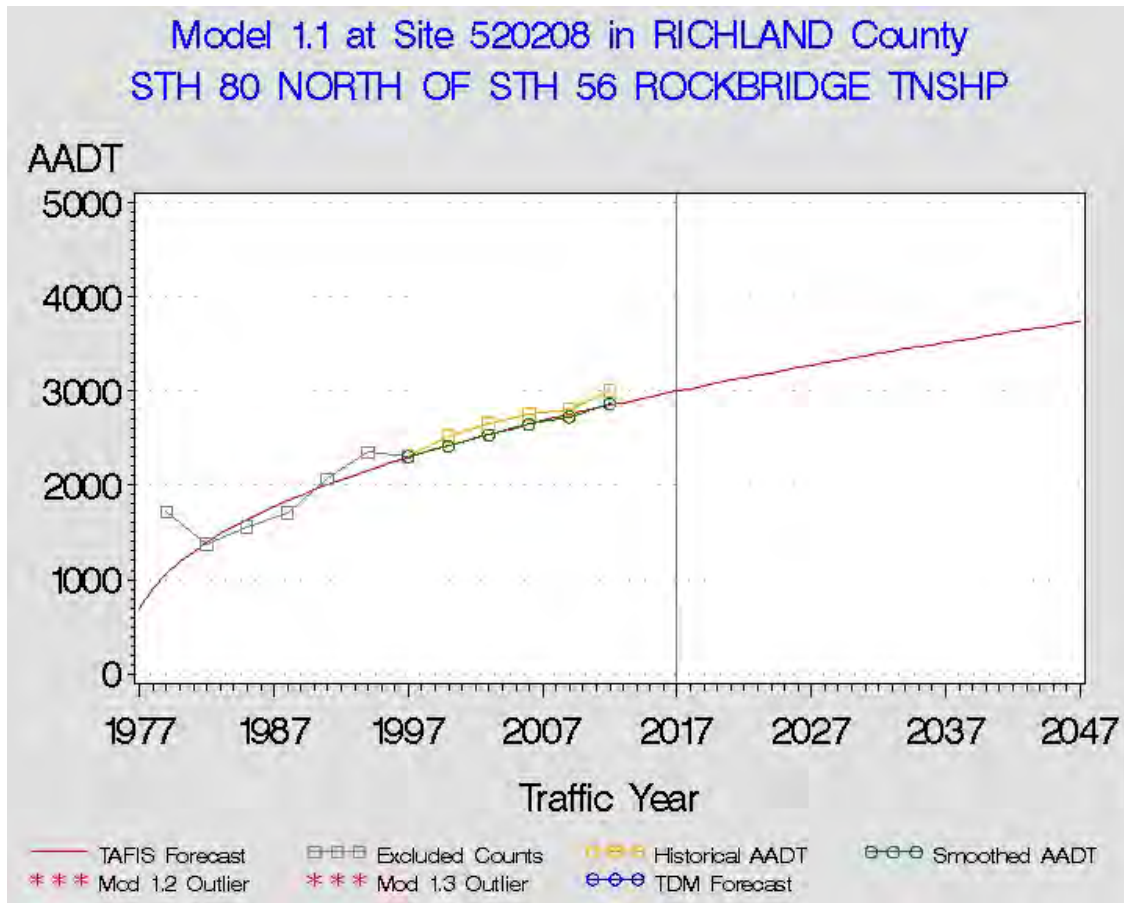

As further explained in [Section 30, Subject 3](#), exponential smoothing is applied to the historical traffic counts (AADT values) used in TAFIS. WisDOT studied exponential smoothing and found it to be a valid method for reducing random variation in traffic counts. In the examples of TAFIS graphical outputs, the smoothed AADT values are displayed in green and the AADT counts are displayed as a reference in orange. Counts older than 20 years are displayed in gray, but are not considered in the regression.

### Location-to-Location Model – TAFIS Model 2.1

TAFIS uses a Location-to-Location Model –Model 2.1 for sites with five or more historical traffic counts which do not produce a significant regression using the Box-Cox Model – Model 1.1. In this process, the two surrounding sites, next to the original site, are checked to see if they produce a significant regression using the Box-Cox Model. If so, the historical annual average daily traffic counts, on the two surrounding sites, are averaged and regressed against the data on the original site to see if there exists significance in their relationship. When the line is statistically significant and positive sloping, the alpha and the beta values are used to develop a forecast. This approach assumes that the traffic at a given location on a highway has a relationship to the traffic at the surrounding traffic count sites on that highway.

TAFIS Model 2.1 produces significant results for a small amount of traffic count sites. Model 2.1 remains worthwhile because it moves the TAFIS procedure away from deterministic time-trend forecasting approaches to more causally based multivariate approaches.

Figure 30.2.2: Model 2.1 graphical output at a traffic site in Douglas County

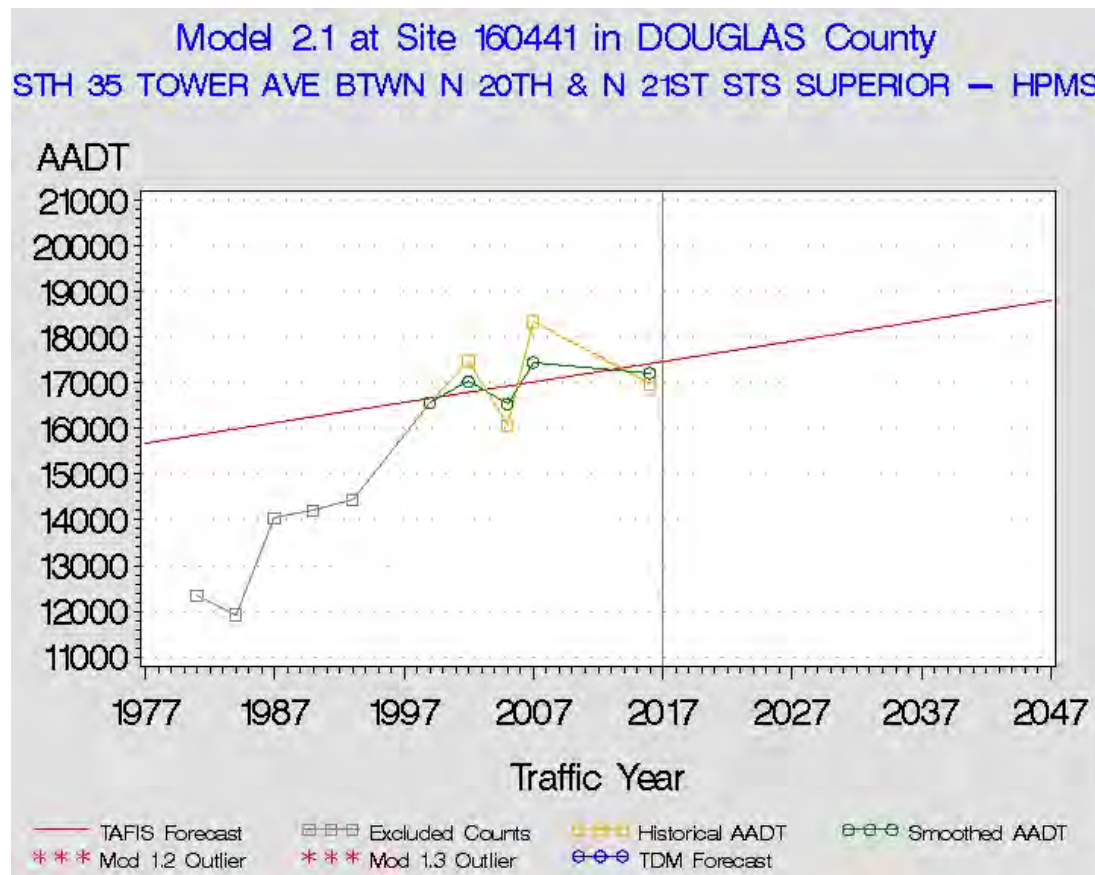



### Cook's D Statistic – Model 1.2 and 1.3

TAFIS uses Model 1.2 or 1.3 for traffic count sites that do not have a statistically significant relationship after applying the Box-Cox Model or the Location-to-Location Model. Historic traffic count outliers are measured by the Cook's D statistic, and examined for replacement and normalizing. If an outlier occurs in the most recent year of historic traffic count observations, the value of the previous count is increased by five percent. If an outlier occurs in the oldest year of observed traffic counts, the value of the subsequent count is decreased by approximately 10 percent. If an outlier does not occur in either the first or last traffic count year, the TAFIS Model 1.2 uses the average value of the two traffic counts surrounding the outlier year. The traffic forecasting section runs the regression again and checks once more for a statistically significant positive slope, creating TAFIS Model 1.2. TAFIS Model 1.2 is used in a small percent of the total traffic count sites.

TAFIS Model 1.3 is similar to Model 1.2. It includes not only the largest outlier, but also the next largest outlier for replacement. This method is used on a very small percentage of traffic count sites. Normalized outliers are represented by a red asterisk on the TAFIS graphical output.

Figure 30.2.3: Model 1.2 Graphical Output at a Traffic Count Site in Columbia County

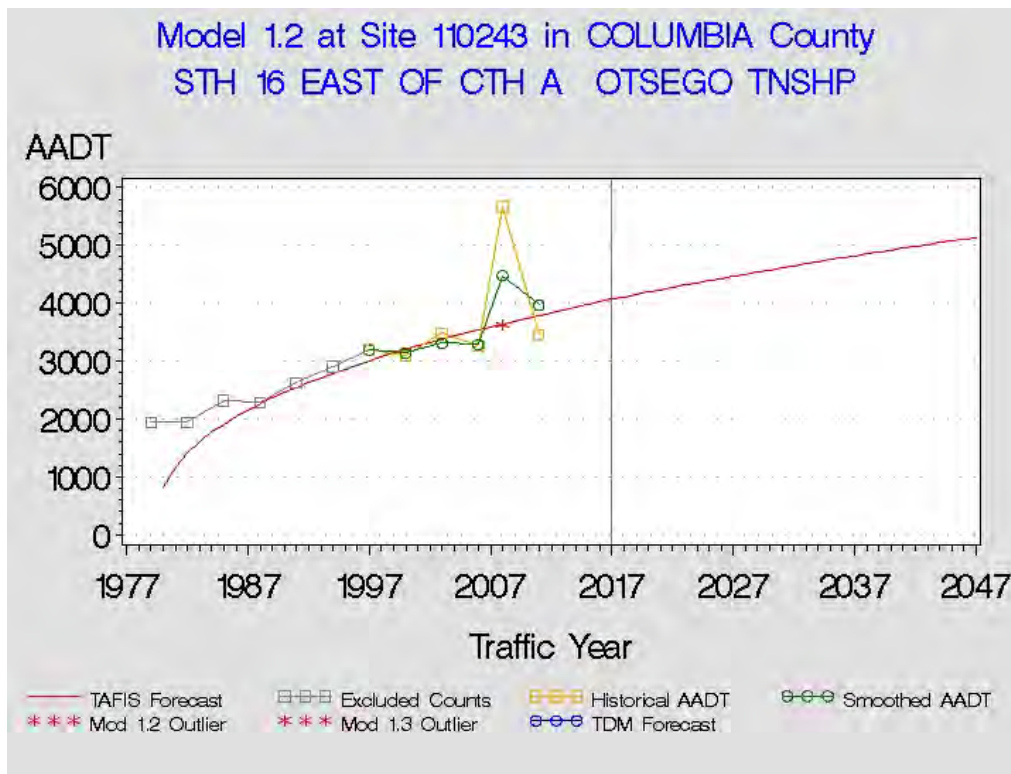

### Average Historic Proportional Relationship – Model 3.1

TAFIS applies Model 3.1 on sites with a non-significant regression, with less than five historical traffic count data points. Sites surrounding the non-significant regression area must have a significant regression. Model 3.1 functions by taking an average of the AADT at the two surrounding sites and then finds a proportional relationship to the AADT estimates at the non-significant site. Therefore, the equation for Model 3.1 is:

$$\text{FORECAST} = \left( \frac{\text{current AADT}}{\text{previous AADT}} + \frac{\text{current AADT}}{\text{following AADT}} \right) / 2 \text{ averaged over all years} \times \left( \frac{\text{current AADT} + \text{previous AADT}}{2} \right)$$

Like Model 2.1 described previously, this method assumes the site's traffic count has a relationship to the traffic count at surrounding sites. However, in Model 3.1, a regression analysis cannot be performed because not enough data exists on the original site. Proportions are averaged over the historical time period, and then averaged to the forecast at the surrounding sites in order to get the forecast for the non-significant segment. A small percentage of segments are modeled using this approach.

Figure 30.2.4: Model 3.1 Graphical Output at a Traffic Site in Jefferson County

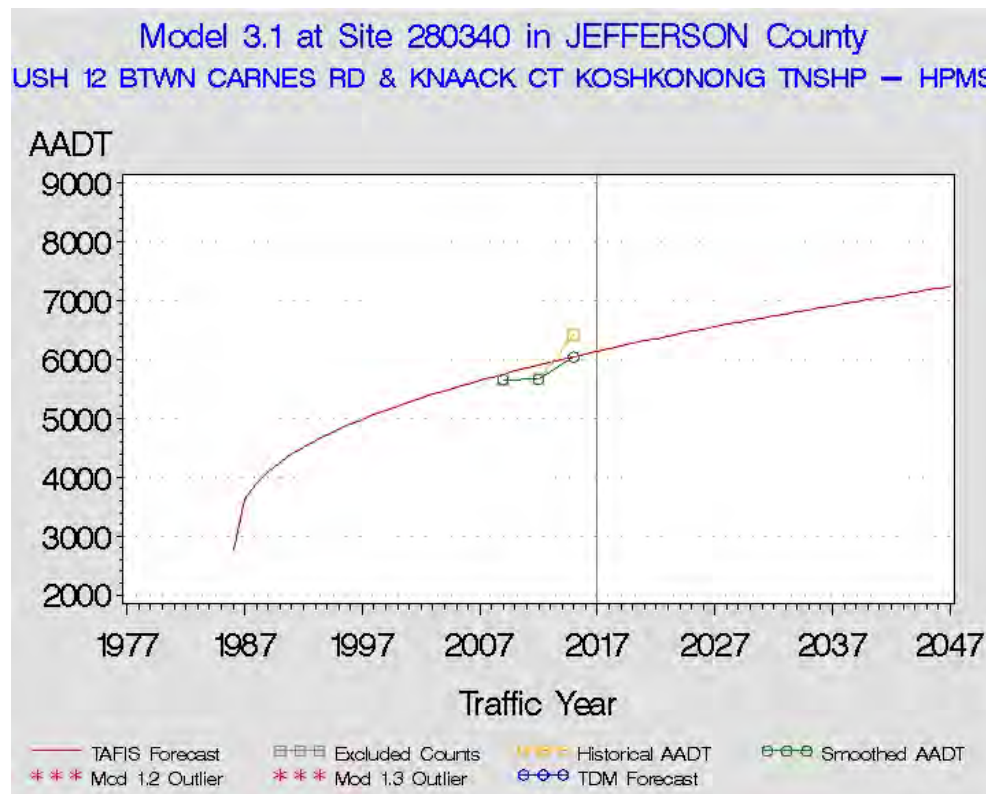

### Application of Specified Growth Rates – Models 4.1 and 4.2

Some TAFIS sites have only one or two historical counts, show decreasing slopes or have anomalous, scattered data that exhibits no discernible pattern. If the slope of the site's count history is positive, TAFIS applies the average growth rate of all Model 1.1, 1.2, and 1.3 sites in the respective county to the latest count at the site when using Model 4.1. If a county has less than five total Model 1.1, 1.2, and 1.3 sites, the average growth rate of all Model 1.1, 1.2, and 1.3 sites in the state is used. Average growth rates for each county are calculated by the traffic forecasting section each year.

$$\text{FORECAST} = (1 + (\text{COUNTY AVERAGE GROWTH RATE} \times \text{TRAFFIC YEAR})) \times \text{LAST AADT}$$

Figure 30.2.5: Model 4.1 Graphical Output at a Traffic Site in Green County

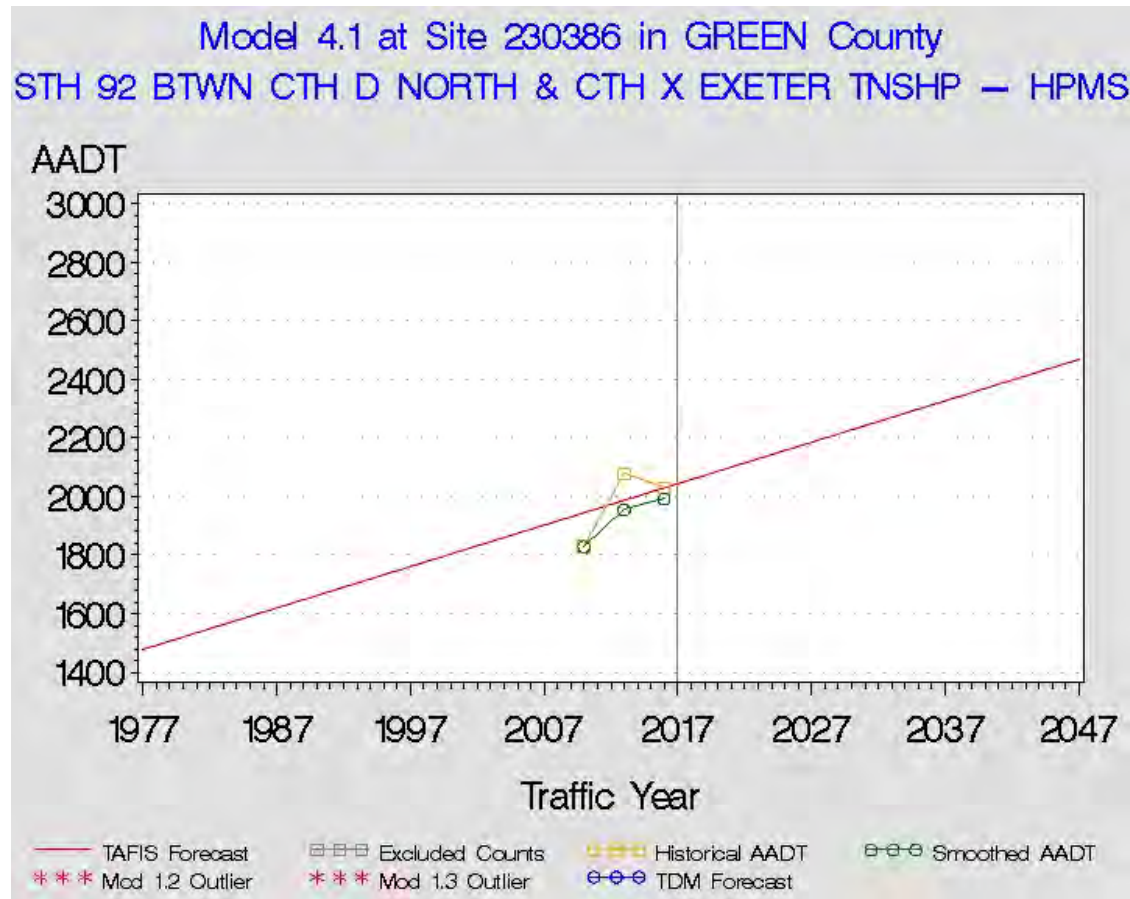

If the slope of a site's count history is negative or flat, TAFIS applies a zero percent growth rate to the most recent count at the site when using Model 4.2.

FORECAST= LAST AADT

Figure 30.2.6: Model 4.2 Graphical Output at a Traffic Site in Adams County

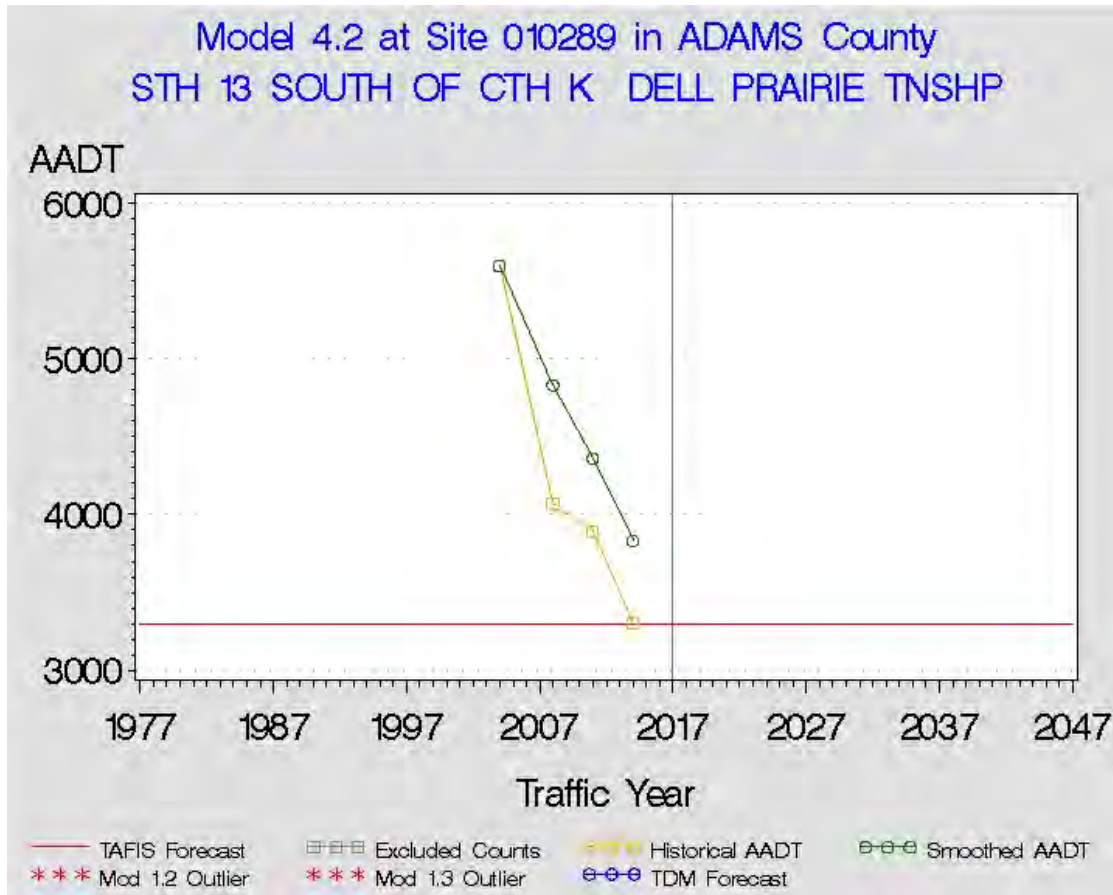

### 30.2.b. TAFIS Logic

The flow chart below briefly summarizes the logic used in the very lengthy and complex SAS® program used for modeling the State Highway System in TAFIS.



### **30.2.c. TAFIS Outputs and Growth Rate Adjustments**

Because TAFIS models are chosen with the most statistically significant result, the line of best fit usually does not pass through the last traffic count point that was collected, calling for an adjustment. WisDOT adjusts final traffic forecasts to project future traffic volumes from the last traffic count volume collected. Count volumes shall be “reasonable” and should not have been altered by exogenous factors such as road construction, equipment malfunction, or other issues. Local knowledge helps to identify if the last count seems reasonable. After the last count has been analyzed for reasonableness, the forecaster will adjust TAFIS outputs to reflect differences in the last count volumes to the forecasted volumes in that same year that the traffic count was collected. This is called a residual and is applied to the future forecast years. For more information on using growth rates and adjustment between travel demand model outputs and TAFIS outputs, see [Section 10, Subject 5](#). The best fit TAFIS model may not fully account for all situations where count data has recently changed.

### **30.2.d. TAFIS Access**

There are two user friendly methods for accessing TAFIS. The first uses the TAFIS TDM Project-Level Forecast Workbook to access the AADT history and forecasts for each year by site ID. The second approach accesses forecasting results using a GIS mapping application which contains hyperlinks to TAFIS graphical outputs.





## **30.3 Enterprise Data Updates**

TAFIS must be regularly updated to remain functional. WisDOT maintains and updates future travel volume data, reported on enterprise-based systems, like TAFIS, throughout the year.

The traffic count cycle or schedule dictates when TAFIS updates occur. The Bureau of State Highway Programs' Data Management Section runs the traffic count program. Unique IDs are assigned to specific count locations on the roadway network. After traffic counts have been collected at those locations, they are processed through traffic data software which applies monthly, day-of-week, and axle factors to estimate the site's annual average daily traffic (AADT), which is stored in a database. After the Data Management Section has processed and stored the new counts in the database, the Traffic Forecasting Section collects the count data and the TAFIS algorithms are calculated.

### **30.3.a. TAFIS Data Reliability**

The traffic forecasting section maintains a historic record of traffic count data, going back to 1976. The database includes all annual traffic counts included in the data management section traffic count cycle and annual average daily traffic (AADT) counts collected by Automated Traffic Recorders. When TAFIS is run, only traffic counts from within the last 20 years are considered in the regressions.

As noted in [Section 30, Subject 2](#), WisDOT requires the TAFIS system to report reliable and statistically significant data. The traffic forecasting section conducts three main data reliability checks, including;

- Confirmation of sites with five or more historic traffic counts
- Compilation of sites that have only one or two counts (usually several hundred)
- Fluctuations in traffic counts on sites that have five or more historic traffic counts

Outliers are expected at a rate of up to 30 percent of the sites. An outlier is a count that differs by more than 20 percent, upward or downward, compared to the previous count year at the same location. This 20 percent

variation serves as a guideline, and all counts are checked for reasonableness. The traffic forecasting section receives input from regional staff that are most familiar with the roadway conditions to find out if the most recent count numbers are reasonable when completing their traffic forecasts (see [Table 70.1.1](#)). By helping to identify causes for dramatic changes in traffic volume including changes in highway design or new development in the area, as opposed to (for example) equipment errors or construction detours, this approach adds to the credibility of forecasts, where base-year AADT estimates change dramatically from one count cycle to the next.

Even prior to TAFIS analysis; however, the Data Management Section reviews traffic counts and determines their acceptability from year to year.

Developed from 48-hour traffic counts, AADT estimates, even under the best of conditions, have considerable sampling error built in them. This occurs even after accounting for seasonal variations, day-of-week variations, and truck (axle counts) count variations. Prior research<sup>4</sup> explains AADT estimates have an estimation error (not including axle errors) of about plus or minus ten percent for urban counts, 16 percent for rural counts, and 30 percent for recreational area counts. Given that data outliers can affect resulting forecasts (especially when there are few traffic volume data points feeding into the forecast to begin with), and that WisDOT projects forecasts from the last traffic volume count taken, it is important that data outlier issues are addressed.

### **30.3.b Traffic Count Smoothing**

As previously mentioned, AADT estimates developed from 48-hour traffic counts have sampling error built in. To remove some of the potential variability, exponential smoothing is applied to the historical traffic counts used in TAFIS. This process removes some of the ‘noise’ in the data and allows for a better-defined trend to be extracted from the traffic counts. [Table 30.3.1](#) contains an example of the method used to calculate smoothed AADT values. In this method, the first count at each site is accepted as is. The subsequent smoothed AADT values are then calculated by adding half of the previous smoothed value to half of the count AADT of the given year.

---

<sup>4</sup> Bruce Aunet. *A Statewide Traffic Counting Program for the Wisconsin Department of Transportation*. WisDOT, January 1987.



**Table 30.3.1: Exponential smoothing example of a traffic count site in Dane County**

<b>Site 130544</b>			
<b>Year</b>	<b>Count AADT</b>	<b>Smoothed AADT</b>	<b>Calculation</b>
2015	10,190	10,863	$(0.5 * 11,536) + (0.5 * 10,190) = 10,863$
2012	12,650	11,536	$(0.5 * 10,423) + (0.5 * 12,650) = 11,536$
2010	10,580	10,423	$(0.5 * 10,266) + (0.5 * 10,580) = 10,423$
2009	10,310	10,266	$(0.5 * 10,221) + (0.5 * 10,310) = 10,266$
2006	9,660	10,221	$(0.5 * 10,783) + (0.5 * 9,660) = 10,221$
2005	11,320	10,783	$(0.5 * 10,245) + (0.5 * 11,320) = 10,783$
2002	11,510	10,245	$(0.5 * 8,980) + (0.5 * 11,510) = 10,245$
1999	8,980	8,980	First count accepted as is



### **30.4 Traffic Forecasts and Meta-Manager**

Meta-Manager is a computer enterprise database managed by WisDOT Bureau of State Highway Programs. Meta-Manager is a comprehensive set of data management system of spatial and tabular analysis tools used for monitoring and defining highway condition and investment priorities. Meta-manager includes:

- Pavement and bridge conditions
- *Six Year Highway Improvement Program* information
- Highway geometric and attribute information
- Highway crashes and crash statistics
- Level of service and highway capacity analysis models
- Improvement “reset” models

The traffic forecasting section provides data for Meta-Manager analysis, including:

- Planning-level annual average daily traffic (AADT) forecasts
- Annual average daily traffic truck percentages from Highway Performance Monitoring System (HPMS) data
- The estimated percent of AADT occurring in the 1<sup>st</sup>, 30<sup>th</sup>, 100<sup>th</sup> and 250<sup>th</sup> highest travelled hours of the year (K1, K30, K100 and K250)

According to WisDOT guidelines, well-established and consistent protocols are used to gather this information so that enterprise-based systems across WisDOT are not in conflict with one another. The data outlined above is found at: <http://wisconsindot.gov/Pages/projects/data-plan/traf-fore/default.aspx>.

The traffic forecasting section assists Meta-Manager function with level-of-service projection inputs and safety inputs. Level-of-service (LOS) is calculated using traffic forecasts and roadway geometry data. For more information regarding LOS, see [FDM 11-5-3](#). Traffic forecasts are also used within the safety data

model, which is comprised of crash tabulations, proportions, rates and flags. Five years of historical annual average daily traffic volumes are provided to generate Meta-Manager crash rates.



### **30.5 Manual Regressions for Traffic Forecasting**

As previously mentioned in [Section 30, Subject 2](#), the TAFIS TDM Project-Level Forecast Workbook is used to perform manual regressions on historical traffic counts. A “manual” regression, as opposed to the automated TAFIS program, may be performed to incorporate traffic counts or sites that are not included in TAFIS.

Using methods similar to those within the Traffic Analysis Forecasting Information System (see [Section 30, Subject 2](#)), traffic count site IDs and historic traffic counts are collected and input to the TAFIS TDM Project-Level Forecast Workbook, which replicates the TAFIS Model 1.1 approach (see [Section 30, Subject 2-Model 1.1](#)). This approach uses a Box-Cox transformation with various values of lambda to project future traffic volumes to be increasing at a decreasing rate. Like TAFIS, exponential smoothing is applied to the historical traffic counts to reduce random variation in the data.

Various lambda values allow traffic forecasting judgment in using an otherwise deterministic time-trend extrapolation forecasting approach. As discussed in [Section 30, Subject 2](#), factors, including adjusting for residuals, taking into account proposed land use changes, changes in roadway geometry, and others affect results. Each site is unique, however, and the forecaster doing the traffic forecast must gather all necessary information with respect to land use development, changes in roadway geometry, and other factors to arrive at the most credible forecast prediction. If available for the location, a travel demand model would also be considered for the forecast.



## **30.6 Related Section Policies: Traffic Analysis Forecasting Information System (TAFIS)**

A summary of the WisDOT policies that were discussed in this section are:

It's WisDOT policy:

- To produce forecasting models for all state highway segments in TAFIS.
- To program TAFIS to use a series of prediction models including:
  - TAFIS Model 1.1 (Box-Cox)
  - TAFIS Model 2.1 (Location-to-Location)
  - TAFIS Model 1.2 and 1.3 (Cook's D Statistic)
  - TAFIS Model 3.1 (Average Historic Proportional Relationship)
  - TAFIS Model 4.1 and 4.2 (Application of Specified Growth Rates)
- To apply exponential smoothing to historical traffic counts volumes to reduce random variation in the data for TAFIS and manual regressions.
- To maintain and update future travel volume data, reported on enterprise-based systems like TAFIS and Meta-Manager throughout the year.
- To adjust traffic forecasts to project future traffic volumes from the last traffic count volume collected.

**Traffic Forecasting, Travel Demand Models and Planning Data****Section 40 – Data Elements of Roadway Traffic Forecasting**

Subject No.	Subject Title	Effective Date
Section 40 (All Subjects)		
40.1	<a href="#">Introduction</a>	May 2018
40.2	<a href="#">Estimating Vehicle Miles of Travel</a>	December 2012
40.3	<a href="#">Geometric Design Factors</a>	May 2018
40.4	<a href="#">Continuous Count Data and Adjustment Factors</a>	December 2012
40.5	<a href="#">Truck Analysis for Traffic Forecasting</a>	May 2018
40.6	<a href="#">Related Policies</a>	May 2018



## **Transportation Planning Manual**

Wisconsin Department of Transportation

### **Chapter 9, Section 40**

### **Data Elements of Roadway Traffic Forecasting**

#### **Subject 1**

#### **Introduction**

## **40.1 Introduction**

As noted in [Section 1, Subject 4](#), roadway traffic forecasts require investigation, sufficient knowledge of best practices, and applied expertise. Design parameters include peak-hour information and truck percentages. Commonly-requested design parameters include:

- K250—the percent of annual average daily traffic (AADT) occurring in the 250th highest traveled hour of the year
- K100—the percent of AADT occurring in the 100th highest traveled hour of the year
- K30—the percent of AADT occurring in the 30th highest traveled hour of the year, the most commonly used K factor and the one most commonly used in FHWA analyses
- P(PHV)—the percent of AADT occurring in the highest traveled hour of the year
- T(DHV)—the percent of trucks during the 100th highest hour of the year
- T(PHV)—the percent of trucks during the highest travel hour of the year
- Truck Class Percent—the percent of heavy trucks by AADT

These parameters are found on the website listed here: <http://wisconsindot.gov/Pages/projects/data-plan/traf-fore/default.aspx>.



## **40.2 Estimating Vehicle Miles of Travel (VMT):**

Vehicle miles of travel (VMT) indicate travel intensity on the roadway system. WisDOT provides VMT annually, as it is used for federal and state budgeting purposes, crash analysis, and for general travel behavior analysis from year to year. As reported to FHWA, VMT is calculated by the summed product of segment AADT multiplied by roadway segment length for each roadway segment where a traffic count is taken.

### **40.2.a. Methodology**

WisDOT's Traffic Forecasting Section analyzes traffic volume information and fuel usage data to produce the official Wisconsin estimates each year by highway jurisdiction, by functional classification, and by county. Three sources of information are used to estimate VMT:

- Automatic Traffic Recorder (ATR) continuous traffic counts
- Highway Performance Monitoring System (HPMS) data
- Wisconsin Department of Revenue (DOR) fuel consumption figures

To produce annual VMT, this information is reviewed for error and logically compiled. Annual VMT increases or decreases as a result of the data comparison from the previous year to the current year.

#### ATRs

Traffic forecasting derives the weighted average percent change in traffic from year to year at automated traffic recorder (ATR) count sites. ATRs continue to be the best source of traffic count data. See [Section 40, Subject 4](#), for more information about ATRs.

#### HPMS Data

The Highway Performance Monitoring System (HPMS) provides a complete picture of statewide travel, both for the state trunk highway network and for local roads. Every year, as noted in [Section 30, Subject 3](#),



traffic counting occurs on a rotating basis, on roughly one-third of the state trunk highway system. While many traffic counts are collected, most are short term or 48-hour counts; some are on ATRs. After traffic counts have been collected, the data management section uses traffic data processing software which adjusts traffic volumes to account for seasonal, daily, axle and monthly factors and enters the data into a database. Time-of-day, day-of-week, weather conditions, and a variety of other factors influence error likelihood, although factoring errors are rare. WisDOT makes every attempt possible to scan for quality and consistency in data collection.

### Fuel Consumption Figures

The Wisconsin Department of Revenue collects fuel consumption data based on motor vehicle fuel taxes. The traffic forecasting section then applies fuel efficiency assumptions to fuel consumption figures to estimate this component of statewide VMT. In addition, diesel fuel consumption and efficiency also helps WisDOT estimate commercial vehicle travel.

### **40.2.b. Results**

Wisconsin's annual HPMS federal submittal contains VMT. WisDOT recognizes HPMS VMT as one component to its statewide VMT value. A weighted average of continuous traffic counts, 48-hour counts, and fuel consumption against fuel efficiencies generates Wisconsin's final estimated annual VMT every year. Each factor is given a weight based on logical data confidence levels. The result provides the estimated percent change in annual VMT. The percent change is then applied to the previous year's VMT estimate and tested for accuracy against real traffic counts.

After compilation and verification, the final estimate is posted on WisDOT's web site. Final statewide VMT figures for previous years are located at: <http://wisconsindot.gov/Pages/projects/data-plan/veh-miles/default.aspx>.



## 40.3 Geometric Design Factors

The traffic forecasting section maintains geometric design hour factor data and design hour traffic volume percentages, or K-factor data, as part of the overall forecasting duties. Highway geometric design hour volumes (DHVs) are the percentages of annual average daily traffic (AADT) expected to occur during a specific hour of the year. In general, the "design hours" are the 30th highest hour or  $K_{30}$ , the 100th highest hour, or  $K_{100}$ , and the 250th highest hour, or  $K_{250}$ . Peak hour or "P," represents the ratio of the highest hourly volume in the year to AADT, expressed as a percentage. "K" represents the percent of AADT in the "design hour" and whether that hour represents the 30th, 100th, or 250th highest hour of the year.

To calculate the method to derive K values, WisDOT generally uses statistical analysis. The Bureau of Planning and Economic Development's Traffic Forecasting Section updates K-factors and associated policies pertaining to their analysis as necessary. Updates have occurred in 2012, 2007, 1991, and 1981.

### 40.3.a. Design Hour Volume Development

See [FDM Section 11-5-3 Subject 3.5.1](#) for a detailed discussion of how to select the appropriate design hour volume. This section explains the sources typically used to develop design hour volumes. The standard measurement for forecasting traffic is annual average daily total (AADT) volume. However, a level of service analysis and other traffic analyses used to determine the performance of a highway facility are typically conducted using hourly or sub hourly traffic volumes. The traffic pattern on any highway shows considerable variation in traffic volumes throughout the day and year. The traffic volumes used for a traffic analysis are referred to as the design hour volumes (DHV). Therefore, processes are needed to derive the design hour volumes from the AADT traffic forecasts.

The four primary information sources typically used to develop design hour volumes are:

- 1) Automatic Traffic Recorder (ATR) Design Hour Volume (DHV)
- 2) K-Factor Regression

- 3) Turning Movement Counts
- 4) Travel Demand Model (TDM) Refinements

The following sections describe the four information sources in detail. The data for ATR and K-factor regressions can be found on this website: <http://wisconsin.gov/Pages/projects/data-plan/traffore/default.aspx>. Turning movement count and TDM refinement design hour volumes can be requested using form [DT1601](#).

#### ATR Design Hour Volume

In this method, the standard practice is to describe the highest hourly volumes relative to the AADT by dividing the hourly volume by the AADT. This quotient is called a design hour factor or K-factor and is calculated for the Kth highest hourly volume in a given year. For example, K30 is the 30<sup>th</sup> highest hourly volume at a site divided by the AADT at that site. For the rank of the hourly count to be valid, the majority of hours in the year need to have been counted. Therefore, K-factors are calculated at locations where traffic counting equipment has been permanently installed to count every vehicle that passes. This configuration of equipment is called an “Automatic Traffic Recorder” or “Continuous Count Site”. Also, some ATR sites classify each vehicle that passes. In addition to calculating design hour factors, the data collected by these sites are useful for understanding daily, weekly, monthly, and annual traffic patterns. The vehicle classification data can also be useful for applications where the number of large vehicles or trucks is an important consideration such as pavement design and workzone planning. WisDOT has developed an ATR DHV Tool that can be used to retrieve traffic count data from a single continuous count site for a single year. The tool reports continuous count data in a format that supports the determination of design hours by direction and other applications. WisDOT staff can download a copy of the tool at the following link: [ATR DHV Tool](#).

#### K-Factor Regression

Statewide continuous count site data are analyzed to develop a statistical estimate of design hour factors that can be applied generally to other WisDOT traffic count sites. These count sites are grouped based on common geographic characteristics and traffic patterns. The K-factors calculated at each individual site within a group are generalized for application to traffic count locations that collect data on a short-term basis and share the same geographic characteristics and traffic patterns. The data are partitioned to achieve statistically significant results. See Sections 40.3.b for a detailed discussion of this method. Because the

traffic counts used to calculate K-factors are taken between intersections or major access points, K-factors are suitable for calculating hourly volumes at these same types of locations.

### Turning Movement Counts

Some locations experience high volumes on a repeating, daily basis. In this case, it is common to use a smaller sample of data taken at the location of interest than to try and infer the behavior at that location from data taken at other locations. This is especially true for counting traffic volumes at intersections and tracking which movement each vehicle makes. Intersection counts are costly and therefore the raw hourly volumes at a site are typically used as the starting point for developing the design hour volumes.

Design hour volumes can be developed using turning movement count data collected at an intersection(s). A forecast of design hour turning movements can be developed from turning movement count data. The turning movement count data should be attached with the forecast request, and the request should indicate the relevant time periods in the turning movement forecast section of the request form (AM, PM, Midday/MD, and Daily/AADT). The traffic forecast request form can be found here ([DT1601](#)). Turning movement count data represent a single point in time and are not factored to account for daily or seasonal variation (except for Daily/AADT turning movement data which are typically factored). Project needs determine the appropriate time to collect this data.

### TDM Refinements

A travel demand model (TDM) can be used to estimate daily or hourly volumes. The volumes output by the TDM may be factored or used directly depending on the context.

Design hour volumes and factors can be developed by refining an existing TDM. The Dane County TDM has been refined to produce AM and PM hourly volumes as well as midday and nighttime period volumes. The Northeast Regional TDM has been refined to produce AM, midday, PM, and nighttime period volumes. The Southeastern Wisconsin Regional Planning Commission (SEWRPC) has also refined their TDM to produce peak period volumes. Projects in areas covered by these TDMs may request peak hour/period forecasts developed from TDM outputs. However, it should be noted that TDMs have been validated to daily total volume but not peak hour or peak period volume. See [Figure 10.1.1](#) for a map of TDM locations and [Section 20](#) for more information regarding individual TDMs.

**Table 40.3.1: Guidelines for the selection of appropriate design hour development methods**

<b>Method</b>	<b>Freeway/Mainline</b>	<b>Arterial/Intersection</b>	<b>Typically Appropriate For</b>
<b>ATR DHV</b>	Typically used to determine appropriate design hour and design hour volume/factor at specific continuous count site locations.	May be used in conjunction with other data and methods depending on project-specific considerations.	Mainline traffic analysis when a continuous count site is within a reasonable range of the project/study limits.
<b>K-Factor Regression</b>	Typically used to calculate standard design hour factors at short-term count sites.	May be used in conjunction with other data and methods depending on project-specific considerations.	Mainline traffic analysis when a continuous count site is not within a reasonable range of the project/study limits.
<b>Turning Movement Counts</b>	May be used in conjunction with other data and methods depending on project-specific considerations.	Typically used to determine appropriate design hour and design hour volume/factor at a specific intersection.	Arterial/Intersection traffic analysis.
<b>TDM Refinement</b>	Typically used to determine anticipated design hour volume/factor for transportation alternatives/scenarios.	Typically used to determine anticipated design hour volume/factor for transportation alternatives/scenarios.	Simulation model development and scenario/alternative analysis.

#### **40.3.b. K-Factor Regression Background**

Highway seasonal adjustment factor groups correspond to the seasonal (monthly) variation of traffic volumes, as identified by the automatic traffic recorder (ATR) stations across Wisconsin. Highway seasonal adjustment factors are assigned by the Bureau of State Highway Programs' Data Management Section. Factor groups 1 and 2 apply to urban highways. In urban areas, there exists little seasonal variation in traffic volumes. Groups 3 and 4 apply to rural highways. In rural areas, there is moderate seasonal variation in traffic, with some peaking; meaning that traffic volumes go up about 20 percent over AADT in the summer months and down by the same amount in the winter months. Groups 5 and 6 apply to highways in and leading to tourist and recreational areas. On highways in and leading to recreational areas, considerable

seasonal variation in traffic is found, with high peaking; where traffic increases 30-45 percent or more over AADT in the summer months.

Analysis also showed that the capacity of a roadway helps determine the peak hour volumes. As capacity increases, the volume of the peak hour also increases. This is due to an increase in overall volumes as well as an increase in the rate at which the peak hours change. This was determined after a multivariate analysis of the K-factors in relation to overall AADT on the roadways. The result of this analysis is a grouping of roadways by seasonal factor group and number of lanes.

The odd numbered seasonal groups (1, 3 and 5) refer to interstate highways and even numbered groups (2, 4, 6 and 8) refer to non-interstate highways. The six seasonal adjustment factor groups include:

- Factor Group 1 - Urban Interstate
- Factor Group 2 - Urban Other
- Factor Group 3 - Rural Interstate
- Factor Group 4 - Rural Other
- Factor Group 5 - Tourist/Recreational Interstate
- Factor Group 6 - Tourist/Recreational Other

Group 8 is not shown above. It applies to county trunk highways; mostly rural, lower volume roads. Group 8 displays different peaking characteristics than state trunk highway rural roads. To account for capacity changes the arterials and collectors were grouped as two lane and multi lane, where multi-lane was considered any roadway with more than two lanes.

K-factor data is available here: <http://wisconsindot.gov/Pages/projects/data-plan/traf-fore/default.aspx>.



## **40.4 Continuous Count Data and Adjustment Factors**

WisDOT maintains more than 200 permanent, continuous data collection stations or automated traffic recorders (ATRs) on Wisconsin's roadways. WisDOT collects ATR data and produces several reports, including but not limited to:

- Daily, weekly and yearly counts
- Factor groups (day-of-week, seasonal)
- Functional classification
- Historical counts and trends
- Peak through 500th highest hour statistics
- Percent annual average hourly traffic volume

The number of and reporting capabilities of individual ATRs affect results. Because ATRs are expensive, WisDOT attempts to gather statistically valid samples to provide increased data confidence and integrity.

Coverage counts are traffic counts collected cyclically at nearly 30,000 locations throughout the state. They are not continuous; rather they are usually 48-hour counts with a pneumatic tube counter placed across a roadway. State trunk highways have varying coverage count schedules. Coverage counts are on WisDOT's web site and are found at:

<http://wisconsindot.gov/Pages/projects/data-plan/traf-counts/default.aspx>.

### **40.4.a. Factors for annual average daily traffic**

WisDOT analyzes the continuous count and vehicle classification data collected during the same year as the coverage count data (January 1 to December 31) to develop factors used to compute annual average daily traffic (AADT). Estimated AADT is developed by multiplying raw counts by seasonal, day-of-week, and axle adjustment factors.

WisDOT then produces:

- Monthly seasonal adjustment factors
- Day-of-week factors for each seasonal group
- Monthly axle adjustment factors by functional classification group, including interstates
- Axle adjustment factors determined by functional classification exceptions
- Annual growth factor groups

#### **40.4.b. Traffic forecasting and automated traffic recorders**

Traffic count accuracy depends on equipment limitations, malfunctions and trained expertise in data collection. Automatic traffic recorders (ATR) provide more accurate traffic count data over coverage count tube stations because of both equipment sophistication and longer count duration. WisDOT converts, factors, and adjusts ATR data using statistically valid procedures. In roadway traffic forecasting, ATRs are used for primarily three purposes:

1. To derive estimates of AADT
2. To provide generalized peak and design hour factors for highway geometric design
3. To monitor annual changes in traffic volumes

The formula for estimating AADT using ATR data is as follows:

$$\text{AADT} = \text{CC} \times \text{SAF} \times \text{DOW} \times \text{AAF}$$

Where:

- CC = Coverage Count
- SAF = Seasonal Adjustment Factor
- AAF = Axle Adjustment Factor
- DOW = Day of Week Factor



#### **40.4.c. SAF or seasonal adjustment factors**

WisDOT uses the month of year as the unit of measure for the seasonal factoring procedure. Monthly traffic volume data is used to group ATRs into seasonal factors based on similar seasonal patterns of monthly traffic volumes. Monthly volumes are also used to determine adjustments to coverage counts to arrive at the AADT. Monthly adjustment factors and day-of-week factors, for each seasonal group, are then produced. The week can also be used to factor seasonal variation, where necessary to factor, or seasonally adjust, coverage counts when estimating AADT.

SAF factors are found by contacting the Bureau of State Highway Programs' Data Management Section.

#### **40.4.d. DOW or day-of-week factors**

In addition to seasonal adjustments, WisDOT uses day-of-week (DOW) adjustment factors to account for daily traffic volume variation. Day-of-week adjustments exist for all days of the week and vary depending on the ATR location. In the Madison area, on I-39/90 for example, the largest adjustments are given to Friday through Sunday because peak travel generally occurs during Friday and Sunday afternoons.

DOW factors are found by contacting the Bureau of State Highway Programs' Data Management Section.

#### **40.4.e. AAF or axle adjustment factor**

In addition to variations due to seasonality and DOW sampling, short period traffic counts collected with road tubes are subject to axle inflation or vehicle over-count error. Road tubes count axles, not vehicles, and most portable traffic counters record one vehicle for every two impulses. For example, without adjustment, if a five axle semi crosses a tube it would be counted as 2.5 vehicles. Typical AAF error is in the range of 10-15 percent; however, errors have been found as high as 50 percent. WisDOT made no adjustment for axle error prior to 1990, as is done currently.

AAFs are found by contacting the Bureau of State Highway Programs' Data Management Section.



## **40.5 Truck Analysis for Traffic Forecasting**

The percent of heavy trucks and vehicles out of all vehicles on a roadway is useful for planners and engineers in designing roadways, particularly pavement. Vehicle classification includes axle-based data and length-based data. WisDOT's heavy truck and vehicle classification follows federally recognized data collection procedures.

Truck class percent is the percent of heavy trucks and heavy vehicles of annual average daily traffic volumes. Heavy truck/vehicle classification is reported using the following groupings:

- 2D—single unit, dual rear tires, two axles only
- 3AX—single unit, three or more axles
- 2S1+2S2—three or four axle tractor-semitrailers
- 3S2—five or more axle tractor-semitrailers
- DBL-BTM—Includes multiple semitrailers and/or trailers

WisDOT analyzes axle and length-based data together to estimate heavy trucks and vehicles. The integration of the axle-based and length-based systems is not seamless, as there is not a one-to-one relationship between vehicle length and the number of vehicle axles. The current (2017-present) length-based groupings WisDOT uses are:

- 0-7 feet
- 7-29 feet
- 29-45 feet
- 45-200 feet

Heavy vehicles are 29 feet or longer. Heavy trucks are single or multi-trailer trucks that are 45 feet or greater in length.

The length based groupings used by WisDOT from 2015-2016 were:

- 0-7 feet
- 7-19 feet
- 19-33 feet
- 33-200 feet

The length based groupings used by WisDOT from 2011-2014 were:

- 0-9 feet
- 9-24 feet
- 24-40 feet
- 40-75 feet
- Greater than 75 feet

#### **40.5.a. Average daily truck percentage estimates for Wisconsin roadways**

Several conditions influence heavy truck/vehicle percentages and they can vary from site to site. Truck percentages can vary in the future, based on the overall rate of growth of heavy trucks/vehicles versus all vehicles. Generally, the percent of heavy trucks/vehicles compared to overall traffic volume decreases with increased total volumes. However, depending on economic conditions and other factors, heavy truck/vehicle volume can increase faster than total vehicle traffic volume. Traffic can vary depending on the measure of time analyzed as well. For example, weekday vehicle classification differs from daily vehicle classification data. Currently, WisDOT data outputs show that more trucks travel on weekdays than weekends. As much as 20-40 percent more trucks are traveling on the average weekday (Monday through Friday) than are traveling on the average day during the typical week (Saturdays and Sundays included).

Vehicle classification data collected by the Bureau of State Highway Programs (BSHP) is available here:

<http://wisconsindot.gov/Pages/projects/data-plan/traf-fore/default.aspx>.



## **Transportation Planning Manual**

*Wisconsin Department of Transportation*

**Chapter 9, Section 40**

**Data Elements of Roadway Traffic Forecasting**

**Subject 6**

**Related Policies**

### **40.6 Related Policies: Data Elements of Forecasting**

A summary of the WisDOT policies that were discussed in this section are:

It is WisDOT policy:

- To estimate vehicle miles of travel yearly.
- To analyze axle and length-based data together as well as ATR data to estimate trucks.
- To maintain, estimate, and identify appropriate geometric design hour factor data and design hour traffic volume percentages for roadways using mathematically valid procedures.

Traffic Forecasting, Travel Demand Models and Planning Data

Section 50 – Traffic Impact Analysis (TIA)

Subject No.	Subject Title	Effective Date
Section 50 (All Subjects)		
50.1	<a href="#">TIA Forecasts</a>	May 2018
50.2	<a href="#">TIA Review</a>	May 2018
50.3	<a href="#">Wisconsin TIA Guidelines</a>	May 2018
50.4	<a href="#">Related Policies</a>	May 2018



### 50.1 TIA Forecasts

WisDOT's [Facilities Development Manual \(FDM\), Chapter 7: "Access Control"](#), defines a Traffic Impact Analysis (TIA) as:

An engineering study that compares before and after traffic conditions on a road network due to a proposed land use change. For WisDOT purposes, it is produced to identify... the optimum number and location of highway access points and any roadway changes needed to accommodate the traffic generated by the development.

WisDOT's Bureau of Planning and Economic Development Traffic Forecasting Section develops and approves base traffic forecasts that are conducted to support creation of TIAs.

#### 50.1.a. Conducting TIA Base Forecasts

A TIA base forecast follows standard forecast procedures and estimates the future volume of traffic on the roadway. A TIA base forecast is produced as part of the initial TIA analysis. TIA guidance is found in [FDM 7-35-10.2](#) and the WisDOT Bureau Of Traffic Operations' [Traffic Impact Analysis Guidelines](#).

In all forecasts, traffic forecasters document whether any additional traffic generators are included in traffic forecasts within the "Notes" section of the TIA base forecast. Once the TIA base forecast and other gathered supporting information is completed, prepare a TIA following WisDOT's Bureau of Traffic Operations procedures.

#### 50.1.b. Conducting TIA Development Forecasts

In addition to developing the base forecasts to support the creation of TIAs, the traffic forecasting section also conducts development forecasts, or forecasts which includes the traffic generated by the development added onto the base forecasts. Development forecasts are beneficial to the overall evaluation of corridor studies. Prior to generating a development forecast, the base forecast is reviewed to determine if the

proposed development was included as part of the background growth. An assessment of the following items is made to establish if the base forecast included the proposed development:

- For TAFIS based forecasts (i.e. the development is located outside of a travel demand model area) the historical development of land within the area is examined to ascertain if the proposed development is consistent with past development and thus included in the background growth rate.
- For Travel Demand Model forecasts (i.e. the development is located within a travel demand model area) the land uses included in the travel demand model for the development site is reviewed to determine if the proposed development was included in the base traffic forecast projections.
- For either the TAFIS based or Travel Demand Model forecasts, aerials, site visits, and/or discussions with the WisDOT region staff will be reviewed and/or conducted to verify whether the subject development has already been constructed and thus included as part of the existing traffic counts.

The traffic forecasting section follows the flow chart illustrated in [Figure 50.1.1](#) to assess if a development project is already incorporated into the base traffic forecast or if it needs to be added prior to generating the final traffic forecast.

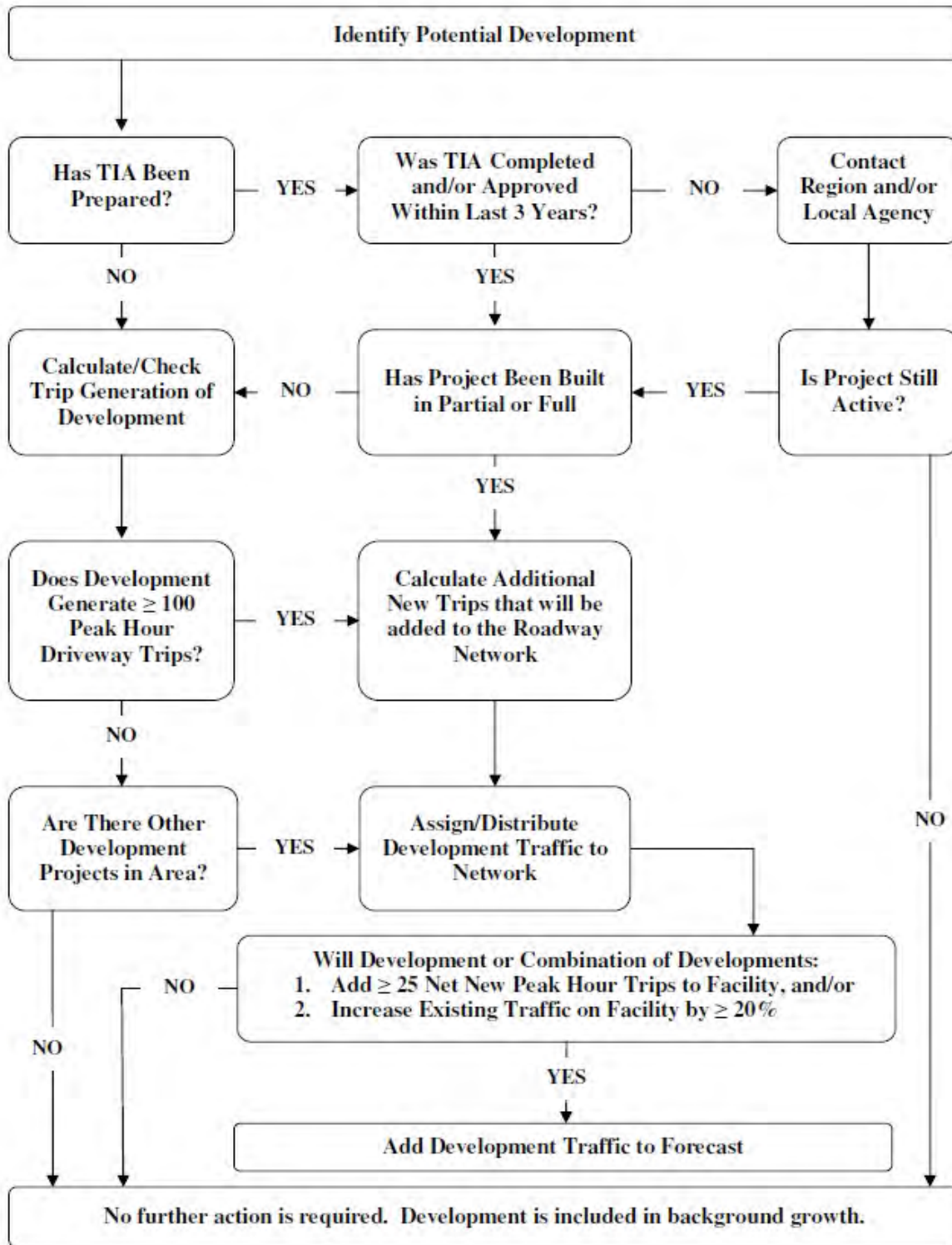

Figure 50.1.1: Development Traffic Forecast Flow Chart



As part of the steps outlined in [Figure 50.1.1](#), the forecasting section considers the following elements in the creation of all TIA development forecasts: (1) trip generation potential; (2) pass-by and/or linked trips; (3) trip distribution/traffic assignment; (4) development phasing schedule; and (5) resulting growth rate. Details on how each of these elements is considered in the development of traffic forecasts are provided below.

#### Trip Generation Potential:

In most cases, the trip generation potential associated with a development project is obtained from the approved TIA. In absence of a TIA, the trip generation potential for the project is calculated by utilizing the WisDOT's Bureau of Traffic Operations accepted methodologies. The most commonly accepted source for trip generation data for land use development is the Institute of Transportation Engineers (ITE) *Trip Generation Manual*, an ITE informational report. The *ITE Trip Generation Manual* provides data in terms of trip rates (average, minimum, and maximum), regression equations (i.e. fitted curve equations), and data plots. A guideline of when to use each source of data in estimating the trip generation potential of a land use is provided in the *ITE Trip Generation Handbook*. See [Chapter 4 of Traffic Impact Analysis Guidelines](#) for recommended guidelines when the average rates, equations, or local data should be utilized for calculating the trip generation of a proposed development. Chapter 4 also contains additional sources of trip generation data that may be appropriate to use.

In all cases, forecasting experts work closely with WisDOT region staff and applicable metropolitan planning organizations to determine the most appropriate trip generation calculations for the development.

#### New, Pass-by and/or Linked Trips:

The standard trip generation rates provide an estimate of the total driveway trips that will be generated by the proposed development. However, some of the driveway trips generated by a development may already be on the existing roadway network (i.e. pass-by trips) and/or may stop at more than one location within the development and/or along the corridor (linked trips) thus reducing the total number of net new trips added to the roadway network. New, pass-by, and linked trips have a significant impact on the number of trips assigned to the highway facility and are therefore critical in the preparation of accurate traffic forecasts. A detailed definition of new, pass-by and linked trips is provided below:

- **New trips** are trips made for the specific purpose of visiting the trip generator. Therefore, these trips are new traffic on the area roadway network. Trip generation rates are derived from actual traffic counts conducted at the driveways of various developments. When dealing with non-commercial land uses such as residential projects, office buildings, hotels, and industrial parks, these driveway volumes usually represent the amount of new traffic being added to the area roadway network by those particular uses.
- **Pass-by trips** are trips that are currently on the roadway system and pass directly by a generator on the way to their primary destination. Pass-by trips are convenience-oriented; for example, stopping to refuel a vehicle during a commute from work. Pass-by trips are applied only to retail-oriented land uses that would have utilized the roadway adjacent to the retail land use even if the development was not present. The amount of pass-by traffic does not affect the number of trips that may enter and exit a proposed development (i.e. driveway volumes). However, it does reduce the amount of traffic that may be added to the adjacent street system by the new development (i.e. new trips). Depending on the type of development and adjacent street traffic volumes, predicted pass-by trips can vary significantly, so these adjustments must be applied carefully. The number of pass-by trips is calculated after accounting for internal trips.

$$\text{External Trips} = \text{Total Site Trip Generation} - \text{Internally-Linked Trips}$$

(Note: Apply pass-by reduction to external trips)

Generally, pass-by traffic should not exceed 5 to 10 percent of the traffic volumes on the adjacent roadways. Pass-by traffic should have equal ingress and egress volumes. WisDOT has developed a set of [acceptable ranges for pass-by rates](#) based on data from the *ITE Trip Generation Handbook, 3<sup>rd</sup> Edition*. The traffic forecasting section works closely with WisDOT region staff to select the appropriate pass-by trip rates for a development.

- **Linked Trips** can consist of internally linked trips, multi-linked trips, and externally linked trips. Internally-linked trips are trips made without utilizing the major roadway system. An internal trip may stop at a drugstore, fast-food restaurant, and a service station within the same mixed-use development (MXD) without using the state highway facility to travel from one land use to another. Internally-linked trips reduce the estimates of the number of trips entering and exiting the proposed

MXD because one entrance and exit to the study area may serve two or more trips. Internally-linked trips also reduce the amount of traffic that may be added to the adjacent street system by the new development. Internal capture rates vary by the mix of land uses, size, the amount of potential interaction between complementary land uses and the availability of convenient internal on or off street facilities and connections. Typically, internally linked trips may be applied to mixed use developments that justify a significant amount of interactions to capture trips internally. The traffic forecasting section follows the WisDOT's Bureau of Traffic Operations procedures for preparing TIAs guidance in selecting a proposed internal capture rate. The traffic forecasting section works closely with WisDOT region staff to select the appropriate internal capture rate for a development.

Multi-linked trips are similar to internally-linked trips. Multi-linked trips may stop at multiple land uses and will use the state highway facility to travel from one land use to another land use. Multi-linked trips affect the estimates of the number of trips entering and exiting the proposed development. One entrance/exit to the study area may serve two or more trips. Multi-linked trips will increase the estimate of the number of trips at specific driveway locations for the new development. The traffic forecasting section works closely with WisDOT region staff to select the appropriate trip generation reduction to account for multi-linked trips.

Externally-linked trips occur when an existing trip stops at a land use within the development and stops at an existing land use within the study area boundaries of the development. Externally-linked trips should be considered only for developments occurring in heavily developed areas such as Central Business Districts.

[Chapter 4 of Traffic Impact Analysis Guidelines](#) contains more sources that may be utilized to estimate the number of linked trips.

It should be noted that although the approved TIA for the development may have incorporated pass-by and/or linked trips; the pass-by/linked trips presented in the TIA are generally conservative numbers and may not be the best data source for utilization in traffic forecast for an entire corridor. Thus the traffic forecasting section works with WisDOT region staff and applicable metropolitan planning organizations to identify the appropriate new trips, pass-by trips, and/or linked trips to incorporate into the final traffic forecast.

### Trip Distribution/Traffic Assignment:

The approved TIA is the primary source utilized to determine how to distribute and then assign the net new trips associated with a development to the adjacent roadway network. In absence of a TIA, or in situations where the study area provided within the TIA does not cover the entire study area for the corridor study, the forecasting sections utilizes the methodologies outlined in [Chapter 4 of the Traffic Impact Analysis Guidelines](#) to estimate the distribution of the traffic generated by a development.

The traffic forecasting section works closely with WisDOT region staff and applicable metropolitan planning organizations when developing the trip distribution percentages for a proposed development.

### Development Phasing Schedule:

Larger developments are generally built over a period of five years or more and thus are included in the traffic forecasts based on the proposed phasing schedule of the development. To determine the most likely project phasing, the traffic forecasting section refers to the phasing schedule and timing outlined in the approved TIA for the development. In absence of a TIA, WisDOT region staff and applicable metropolitan planning organizations are consulted to determine the appropriate phasing to utilize in the traffic forecast. Note, appropriately phasing development is important to evaluate the appropriate traffic and assess the timing of any potential improvements needed along a corridor.

### Overall Growth Rate:

Upon completion of the initial development forecasts, the traffic forecasting section reviews the overall resulting growth rate (growth between existing traffic volumes and traffic volumes with base/background traffic plus development traffic forecast) for reasonableness. As discussed in [Section 10, Subject 4](#), WisDOT applies or chooses an appropriate roadway link growth rate relative to typical forecasting procedures and if there has been significant changes in socioeconomic data, land use, and/or roadway network data. WisDOT also uses analytical judgment to determine if the applied growth rate makes sense. If it is determined that the growth rate of the initial development forecast is too high, the forecasting section will reevaluate the base traffic forecasts to determine if the background growth includes part or all of the proposed development. Additionally, if the initial development forecast is deemed too high, the development traffic itself will be reviewed to verify that the appropriate trip generation rates, new trips, pass-by trips, and/or linked trips were utilized for the development.

As a first resource, the traffic forecasting section will reference a completed/approved TIA to determine the trip generation potential, new trips, pass-by/linked trips, trip distribution/traffic assignment, and phasing schedule for the proposed development. When a TIA does not exist and it's appropriate to conduct one, the WisDOT's Bureau of Traffic Operations procedures ([Traffic Impact Analysis Guidelines](#)) for preparing TIAs will be followed.



## **Transportation Planning Manual**

*Wisconsin Department of Transportation*

**Chapter 9, Section 50**

**Traffic Impact Analysis (TIA)**

**Subject 2**

**TIA Review**

### **50.2 TIA Review**

As noted in [Section 50, Subject 1](#), the traffic forecasting section develops and approves base traffic forecasts that are conducted to support creation of TIAs. As noted in [Section 1, Subject 3](#), if an outside consultant, WisDOT Region, or MPO has completed a traffic analysis, WisDOT's Central Office Traffic Forecasting Section conducts overall review and final determination of approval of all forecasts on the state trunk highway system. All forecasts should be submitted to the traffic forecasting section for review and approval prior to them being utilized for TIA development.

Once a TIA is in draft form, WisDOT region staff reviews the TIA with assistance from others in the department.



## **Transportation Planning Manual**

Wisconsin Department of Transportation

**Chapter 9, Section 50**

**Traffic Impact Analysis (TIA)**

**Subject 3**

**Wisconsin TIA Guidelines**

### **50.3 Wisconsin TIA Guidelines**

The purpose of WisDOT's TIA guidelines is to provide a set of uniform guidelines for the preparation of traffic impact analyses and for efficient department review. For specific and detailed TIA guidelines, contact WisDOT's Bureau of Traffic Operations. TIA preparation is required of developers who propose new developments, or expansions of existing developments, and request new (direct or indirect) access, or modification of, existing access to the state trunk highway system. The guidelines provide a detailed description of how the TIA should be organized—including the list of required TIA exhibits; what types of analysis should be provided in each chapter of the document; and what data should be provided in the appendices.

Additional resources available to assist both the preparers and reviewers of TIAs include the WisDOT's TIA Users Group, the WisDOT *Facilities Development Manual* (FDM) ([specifically Chapter 7](#)), and the WisDOT [Traffic Impact Analysis Guidelines](#).



## **50.4 Related Section Policies: Traffic Impact Analysis**

A summary of the WisDOT policies that were discussed in this section are:

It's WisDOT policy:

- To complete or review traffic forecasts for traffic impact analyses on the state trunk highway system.



Traffic Forecasting, Travel Demand Models and Planning Data

Section 60 – Travel Surveys

Subject No.	Subject Title	Effective Date
Section 60 (All Subjects)		
60.1	<a href="#">Data Collection Reasons</a>	May 2018
60.2	<a href="#">Related Policies</a>	May 2018



### **60.1 Data Collection Reasons**

Travel surveys obtain information about trip patterns, behavior and other traveling characteristics. The data collected during surveys are utilized by WisDOT for two primary reasons: (1) data and policy development and (2) data verification. These are explained in more detail below.

#### **60.1.a. Data and Policy Development**

WisDOT utilizes travel surveys to help provide necessary background data to make decisions. Corridor studies, transportation projects, and program development all have used survey data to improve estimation procedures, planning information, and implementation measures. Data collected during a survey is utilized to identify regional travel patterns, providing a geographic context to evaluate the benefits and costs of large, long-term transportation investment alternatives.

The traffic forecasting section utilizes information obtained from surveys in regional travel demand models. When survey data documents trip purpose, the results can be applied together with results from state or national surveys, to validate modeled travel patterns between employment and residential areas within a community. They can also be used to determine vehicle occupancy rates and travelers mode choice (i.e. bicycle, auto or transit). Results from surveys are used to help predict future traffic volumes and vehicle mix. Less detailed surveys are used by the traffic forecasting section to help calibrate travel speeds and/or external-to-external through-trips within a specific area of a regional travel demand model.

#### **60.1.b. Data Verification**

The National Household Travel Survey (NHTS) data and data from any origin-destination surveys can be compared for better data verification. These surveys also serve as inputs into the travel demand models as part of the roadway forecasting process.

## National Household Travel Survey

The National Household Travel Survey (NHTS) is a household-based survey that provides information to transportation planners and policymakers who need comprehensive data on travel patterns in the United States. The current [2009 NHTS](#) provides data collected for daily trips made over a 24-hour period, and includes information about the following:

- Purpose of the trip (work, shopping, etc.)
- Means of transportation used (car, bus, subway, walk, etc.)
- How long the trip took (i.e., travel time)
- Time of day when the trip took place
- Day of week when the trip took place
- If a private vehicle trip:
  - Vehicle occupancy
  - Driver characteristics (age, sex, worker status, education level, etc.)
  - Vehicle attributes (make, model, model year, amount of miles driven in a year)

The NHTS data is used primarily for gaining a better understanding of travel behavior. The data enables WisDOT officials to assess program initiatives, review programs and policies, study current mobility issues, and plan for the future. NHTS data is used by planners to:

- Quantify travel behavior
- Analyze changes in travel characteristics over time
- Relate travel behavior to the demographics of the traveler
- Study the relationship of demographics and travel over time

As an example as to how traffic forecasting uses the data, the NHTS may have determined that there were between 7.8 and 12.2 average trips per household (depending on the number of automobiles per household) in a given region. The NHTS survey can then be used by the traffic forecasting section to project future regional traffic demand based on the number of households in the region. A localized area or regional survey would then assist traffic forecasting in predicting how those trips are assigned to the roadway network.

### Origin-destination (O-D) surveys

Origin-destination (O-D) surveys are specific travel surveys which obtain information on trip patterns and purposes exhibited by residents in or around a community or specific area of interest. The type of information collected in an O-D can include and is not limited to one or more of the following:

- The degree of local trip making behavior versus through trip making behavior, or how many trips are traveling *to* or *from* the community as opposed to passing *through* it
- Purpose of the trip being made, such as work, recreation, shopping, or other personal business reasons
- Type of vehicle used for the trip, including automobile, heavy duty truck (such as a delivery vehicle or tractor-trailer combination), bicycle, or public transportation
- The number of people in each vehicle



## **Transportation Planning Manual**

*Wisconsin Department of Transportation*

**Chapter 9, Section 60**

**Travel Surveys**

**Subject 2**

**Related Policies**

### **60.2 Related Policies: Travel Surveys**

A summary of the WisDOT policies that were discussed in this section are:

It's WisDOT policy:

- To utilize travel surveys to help provide necessary background data to make decisions.
- To assess travel behavior for long-range transportation plans, project investigations, roadway traffic forecasts, and travel demand model assumptions.
- Define the survey collection method and data collection responsibilities prior to the onset of a travel survey
- Have concern for the inconvenience of the travelling public and the privacy of information about travel
- Maintain the privacy of the survey participants
- Use the traffic forecasting section as the statewide “go-to expertise” in travel survey efforts

**Traffic Forecasting, Travel Demand Models and Planning Data**

**Section 70 – Appendix**

Subject No.	Subject Title	Effective Date
Section 70 (All Subjects)		
70.1	<a href="#">Traffic Forecasting Region Contacts</a>	May 2018



# Transportation Planning Manual

Wisconsin Department of Transportation

Chapter 9, Section 70

Appendix

Subject 1

WisDOT Region Traffic Forecasting Contacts

## 70.1 WisDOT Region Traffic Forecasting Contacts

Region	Traffic Forecasting Contact	Telephone
<b>1</b> Southwest MADISON LA CROSSE	MADISON/LA CROSSE Jean Mancheski (F, LR, TC)	(608) 246-3807
	MADISON Graham Heitz (TIA)	(608) 246-5362
	LA CROSSE Collin Webb (TIA)	(608) 785-9065
<b>2</b> Southeast WAUKESHA	Brent DesRoches (F, TC)	(262) 548-5611
	Allison Blackwood (TIA)	(262) 548-5626
	Dan Malicki (TIA)	(262) 521-5285
<b>3</b> Northeast GREEN BAY	Matthew Halada (F)	(920) 492-7725
	David Nielsen (TIA)	(920) 492-0148
	Rod Hamilton (TIA)	(920) 366-4747
<b>4</b> North Central WISCONSIN RAPIDS RHINELANDER	WISCONSIN RAPIDS/RHINELANDER Dave Meurett (F)	(715) 421-8348
	WISCONSIN RAPIDS/RHINELANDER - Richard Handrick (TIA)	(715) 365-5716
<b>5</b> Northwest EAU CLAIRE SUPERIOR	EAU CLAIRE/SUPERIOR Richard Putzy (F, LR)	(715) 836-2893
	EAU CLAIRE/SUPERIOR Dan Bieberitz (TIA)	(715) 836-2823

Table 70.1.1: WisDOT Region Traffic Forecasting Contacts; (F) = Forecast Requests, (TIA) = Traffic Impact Analysis, (LR) = Local Road Count Info, (TC) = Traffic Counts