

NOTICE OF PROPOSED GUIDANCE DOCUMENT

DTIM-BPED37

Pursuant to Wis. Stat. s. 227.112, the Wisconsin Department of Transportation is hereby seeking comment on DTIM-BPED37, FAST Act, a proposed guidance document.

PUBLIC COMMENTS AND DEADLINE FOR SUBMISSION

Comments may be submitted to the Wisconsin Department of Transportation for 21 days by:

1. Department's website: <https://appengine.egov.com/apps/wi/dot/guidance-docs?guidDocId=DTIM-BPED37>

2. Mailing written comments to:

Division of Transportation Investment Management
Wisconsin Department of Transportation
4822 Madison Yards Way
PO Box 7913
Madison, WI 53707-7913

WEBSITE LOCATION OF FINAL GUIDANCE DOCUMENT

The final version of this guidance document will be posted at wisconsin.dot.gov to allow for ongoing comment.

AGENCY CONTACT

Kaleb Vander Wiele
DOTDTIMGuidanceDocs@DOT.WI.GOV

Acknowledgements

This guide is a product of the Wisconsin Department of Transportation, Division of Transportation Investment Management's Bureau of Planning. John Williams of Tracy-Williams Consulting prepared the guide under contract with WisDOT, with assistance from Tom Walsh, David Harkey, Glenn Grigg, and Todd Litman. Tom Huber of WisDOT managed the guide's development. Significant contributions and review of the document were provided by the WisDOT Bicycle Committee including Mike Rewey, David Genson, Tom Dobson, Pat Fleming, Bob Pfeiffer, and Doug Dalton. Special thanks to David Liebel of the UW-Madison Department of Engineering Professional Development for preparing the section on bicycle path lighting. Beneficial comments and many photos were provided by Arthur Ross and Tom Walsh of the City of Madison. Thanks also to Rob Miller of the WisDOT Office of Public Affairs for his review.

Numerous state bicycle facility design manuals and guidelines were reviewed in the preparation of this handbook and their language formed the basis of some of this guide's recommendations. Their efforts are much appreciated and this guide is intended to contribute, where possible, to future work of these and other agencies as well. Going back to the 1970s, state bicycle facility guides have built upon each other and it is common to see language and graphics from one used in another. This process of incremental improvement is crucial to the development of the field. Primary sources for this handbook include bicycle guides from the states of Arizona, California, Florida, Minnesota, North Carolina, Oregon, and Washington. In several cases, figures and tables were based on — or used directly from these guides. In such cases, these sources were properly credited below the figure or table. Four figures were either based on the *Oregon Bicycle and Pedestrian Plan* or redrawn from the plan. One figure was based on the Florida DOT *Trail Intersection Design Handbook*.

Other significant sources for the development of this guide were the *Guide for the Development of Bicycle Facilities* published by American Association of State Highway and Transportation Officials (AASHTO) and the *Manual of Uniform Traffic Control Devices (MUTCD)* from the Federal Highway Administration. Data from six tables and four figures were used directly from the AASHTO *Guide* to maintain consistency with this national guide. The majority of these tables and graphics covered technical data related to stopping sight distances, crests of vertical curves, and lateral clearances for horizontal curves for shared-use paths. Sources were properly credited below the figures or tables. Similarly, about a dozen graphics were used from the *MUTCD*. Because the *MUTCD* has legal standing, the graphics are identical or nearly identical to those appearing in the *MUTCD*.

In some cases, the same wording for sentences that appear in the AASHTO Guide appear in this guide. This was done in cases where just a small word change in the statement may alter the meaning and, thus, consistency between the two guides. WisDOT is a member of AASHTO and has contributed significantly in the updates of the AASHTO *Guide*.

Photo credits belong to Mike Rewey: figs. 2-32, 2-53, 2-55; Arthur Ross: figs. 2-5, 2-28, 2-43, 2-46, 2-52, 4-158, 4-159; Pat Fleming: figs. 2-11, 3-13; Tom Walsh: figs. 2-24, 2-44; Kurt Miller: fig. 2-27; Donna Brown: fig. 4-1; Dan Burden: figs. 1-6, 2-37, 2-60, 2-78, 3-2, 3-3, 3-6, 3-10, 3-17, 3-20, 3-31, 3-33, 3-34, 3-37, 4-2, 4-9, 4-21, 4-29, 4-37, 4-44, 4-62, 4-71, 4-80, 4-85, 4-87, 4-93, 4-97, 4-99, 4-102, 4-103, 4-109, 4-112, 4-114, 4-115, 4-122, 4-138, 4-139, 4-143, 4-145, 4-151, 4-155; Ellen Fletcher: fig. 2-66; David Takemoto-Weerts: fig. 3-42; Alex Sorton: figs. 3-5, 3-7, 4-67, 4-89, 4-157; Peter Lagerwey: figs. 2-38, 2-42, 2-58, 2-64, 2-75; Bikeinfo.org: fig. 1-7; Gary MacFadden: fig. 2-22; City of Portland, Oregon: 4-84; WisDOT: fig. 2-81; City of Lincoln, Nebraska: fig. 4-90; Kane County Forest Preserve District: fig. 4-130. All other photos by John Williams and Tom Huber.

For information about this document, contact: Jill Mrotek Glenzinski, WisDOT Planning Section, at (608) 267-7757 or (608) 266-3661; by mail at Wisconsin Department of Transportation, Box 7913, Madison, WI. 53707-7913; or by e-mail at: jill.mrotekglenzinski@dot.wi.gov.

WISCONSIN BICYCLE FACILITY DESIGN HANDBOOK

WISCONSIN DEPARTMENT OF
TRANSPORTATION
2004

Tables

Table 2.1: Rural Two-Lane State Trunk Highway Paved Shoulder Width Requirements to Accommodate Bicycles	2-19
Table 4-1: Desirable Minimum Radii for Paved Shared Use Paths	4-15
Table 4-2: Suggested Grade Limits for Paved Shared Use Paths	4-17
Table 4-3: Minimum Length (in feet) of Crest Vertical Curve (L)	4-22
Table 4-4: Minimum Length (in meters) of Crest Vertical Curve (L)	4-23
Table 4-5: Minimum Lateral Clearance (M) for Horizontal Curves.....	4-24
Table 4-6: Minimum Lateral Clearance (M) for Horizontal Curves.....	4-24
Table 4-7: Path Surface Summary	4-26
Table 4-8 Surface Maintenance Treatments	4-33
Table 4-9 Recommended Illumination for Shared-use Paths	4-36
Table 4-10 Path-Highway Crossing Guidance for Rural 2-lane Highway Facilities ..	4-52
Table 4-11: Effects of path-roadway separation distance	4-64
Table 4-12: Overpass and underpass considerations.....	4-70

Wisconsin Bicycle Facility Design Manual

1 Introduction	1-1	4.3.1 Problems with paths next to roadways	4-3
1.1 Bicycle and bicyclist characteristics	1-2	4.3.2 Sidewalk bikeways	4-6
1.2 Design options.....	1-5	4.3.3 Shared-use paths in roadway medians.....	4-7
2 Basic Roadway Improvements	2-1	4.4. Path width.....	4-7
2.1 Roadway types.....	2-1	4.5 Shoulders and clearances.....	4-9
2.1.1 Residential streets	2-1	4.6 Design Speed.....	4-11
2.1.2 Collector streets	2-2	4.7 Horizontal alignment & superelevation.....	4-13
2.1.3 Arterial streets.....	2-4	4.8 Grades.....	4-17
2.1.4 Rural highways	2-5	4.9 Transitions between grades and level ground	4-18
2.2 Pavement quality.....	2-7	4-10 Sight Distance	4-19
2.3 Drainage grates and utility covers.....	2-9	4.11 Pavement structure	4-25
2.3.1 Grate type	2-9	4.11.1 Pavement loads	4-27
2.3.2 Grate or utility cover location	2-10	4.11.2 Vegetation Control	4-28
2.3.3 Grate or utility cover elevation	2-11	4.11.3 Foundation preparation.....	4-29
2.3.4 Temporary measures.....	2-11	4.11.4 Asphalt structural section.....	4-30
2.4 Corner sight lines	2-12	4.11.5 Concrete structural section	4-31
2.5 Wide outside lanes	2-13	4.11.6 Aggregate Structural section	4-31
2.5.1 Retrofitting an existing roadway.....	2-15	4.11.7 Surface smoothness and maintenance	4-33
2.6 Paved shoulders.....	2-17	4.12 Drainage	4-34
2.6.1 Low-volume rural roads	2-17	4.13 Lighting.....	4-35
2.6.2 Overall shoulder width	2-18	4.14 Signing and marking	4-38
2.6.3 Basic recommendations.....	2-18	4.14.1 Regulatory controls	4-38
2.6.4 Guardrails and slopes.....	2-20	4.14.2 Warning devices	4-41
2.6.5 Grades	2-20	4.14.3 Informational devices.....	4-42
2.6.6 Pavement design and loading	2-21	4.14.4 Temporary work zone controls	4-44
2.6.7 Joints between travel lanes and shoulders.....	2-21	4.14.5 Placement of signs	4-45
2.6.8 Unpaved driveways.....	2-21	4.14.6 Sizes of signs.....	4-46
2.6.9 Rumble strips	2-22	4.14.7 Using restraint.....	4-46
2.7 Railroad crossings.....	2-23	4.15 Path-Roadway Crossings.....	4-47
2.7.1 Crossing angles and gaps	2-23	4.15.1 Choosing crossing locations	4-47
2.7.2 Crossing smoothness	2-26	4.15.2 Intersection: yes or no?	4-48
2.7.3 Railroad/path or walkway crossings	2-26	4.15.3 Rural vs. urban/suburban locations	4-50
2.8 Traffic signals	2-27	4.15.3.1 Rural path crossings.....	4-50
2.8.1 Bicycle detection.....	2-27	4.15.3.2 Urban/suburban path crossings	4-53
2.8.2 Signal loop markings	2-29	4.15.4 Crossing design	4-55
2.8.3 Signal timing	2-30	4.15.4.1 Simple signed crossing	4-56
2.8.4 Programmed visibility heads.....	2-30	4.15.4.2 Signed crossings with traffic calming	4-59
2.9 Structures	2-31	4.15.4.3 Signalized crossings.....	4-61
2.9.1 Bridges.....	2-32	4.15.5 Parallel Path Crossings	4-63
2.9.2 Interchanges	2-36	4.15.5.1 Signalized parallel crossings	4-65
2.10 Traffic Calming.....	2-39	4.15.5.2 Signed parallel crossings	4-66
2.10.1 Traffic diversion approaches.....	2-40	4.15.6 Important features of all crossings.....	4-67
2.10.2 Measures for slowing traffic.....	2-42	4.15.7 Grade separations	4-69
2.11 Bicycle Route Designation	2-45	4.16 Shared-use path structures.....	4-71
3 Bicycle Lanes	3-1	4.16.1 Bridges and overpasses	4-72
3.1 One-way vs. two-way bicycle lanes	3-2	4.16.2 Underpasses and tunnels	4-75
3.2 Bicycle lane location.....	3-3	4.16.3 Combining structures.....	4-79
3.3 Bicycle lane surface quality.....	3-8	4.16.4 Separation on Combined Structures.....	4-81
3.4 Bicycle lane width.....	3-9	4.17 Shared Use	4-83
3.5 Bicycle lane designation.....	3-14	4.17.1 Pedestrians and Bicyclists	4-83
3.6 Bicycle lane intersection design	3-18	4.17.2 Motorbikes and motorcycles	4-86
3.7 Intersections with right-turn lanes	3-21	4.17.3 Motor vehicles.....	4-87
3.8 Left-turn bicycle lane	3-23	4.17.4 Horses.....	4-91
3.9 Interchanges.....	3-24	4.17.5 Cross-country skiers and snowmobiles	4-92
4 Shared-use Paths	4-1	Appendices	
4.1 Shared-use path users, purposes, and locations.....	4-1	A Maintenance & Operations.....	A-1
4.2 Designing paths and roads	4-2	B Traffic Conditions & Bridges.....	B-1
4.3 Shared-use paths and roadways	4-3	C Wisconsin Statutes.....	C-1
		D Bibliography	D-1
		E Index.....	E-1

Fig. 1-1: Bicycle Lanes are among the options available to engineers and planners.



1 Introduction

Bicycling plays an important role in moving Wisconsin's people, many of whom rely on or choose the bicycle for their main or only mode of transportation. Bicycles can move considerable numbers of people, especially in urban areas. The Wisconsin Department of Transportation (WisDOT) recognizes the importance of the bicycle as a legitimate mode of transportation and has created this vision "To

establish bicycling as a viable, convenient, and safe transportation choice throughout Wisconsin." In particular, it is WisDOT's position that bicyclists' needs should be considered in virtually all transportation projects. While some projects may not have obvious bicycle implications, many others will. By including bicycling in basic project development and planning, this mode will become an integral part of the total transportation mix.

Recently, WisDOT adopted a Community Sensitive Design (CSD) program. The program reinforces WisDOT's vision for a comprehensive transportation system while at the same time calling for more citizen participation and additional flexibil-

"Bicycle transportation facilities and pedestrian walkways shall be considered, where appropriate, in conjunction with all new construction and reconstruction of transportation facilities, except where bicycle and pedestrian use are not permitted."

FHWA Guidance: Bicycle & Pedestrian Provisions of Federal Transportation Legislation (1999)

"Bicycle provisions on urban arterial streets (i.e., wide curb lanes, bicycle lanes or paved shoulders) should be made in accordance with MPO and community bicycle plans unless the costs or adverse impacts of such accommodations are excessively disproportionate to expected usage. Communities that do not have bicycle plans should seriously consider bicycle accommodations on arterial streets."

Wisconsin Bicycle Transportation Plan 2020 (Dec. 1998)

ity in roadway design standards. As a starting point for projects designed under CSD, bicycle and pedestrian accommodations should be assumed to be part of those projects. This guide will act as a detailed resource in how to accomplish that.

Designers have a wide range of possible options for enhancing a community's bicycle transportation system. On the one hand, improvements can be simple, inexpensive, and involve minimal design effort. For example, adopting a "bicycle-safe" drainage grate standard, patching pot holes on popular bicycling routes, or adjusting traffic signal timing can be an inexpensive ways to make bicycling safer and more enjoyable.

On the other hand, some improvements can involve substantial allocations of funds, carefully prepared detailed designs, and multi-year commitments to phased development. An example might be the implementation of an extensive community-wide trail network or building a key bicycle bridge to get bicyclists past a major bicycling barrier.

In order to adequately design for bicyclists, particularly when approaching large-scale projects, one must have a basic understanding of how bicycles operate. Most designers have an intuitive understanding of such aspects for motor vehicle operation from years of driving. But that understanding is less common when designers deal with bicycles. As a result, it is important to begin with basic concepts and characteristics.

Note: Photos are categorized by their content:

- YES** Positive example
- OK** Special case example
- NO** Not recommended.

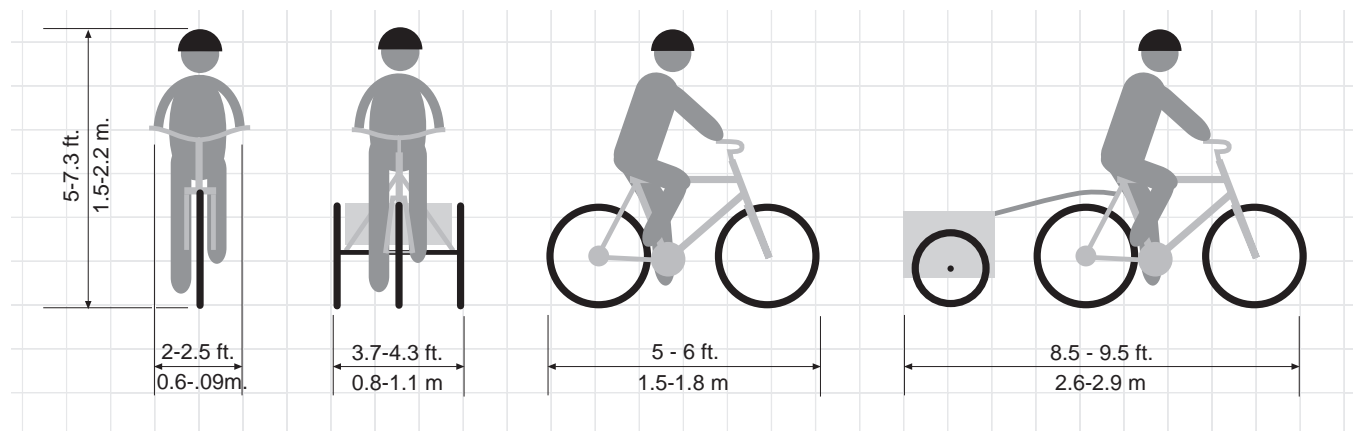

1.1 Bicycle and bicyclist characteristics

Physical size: The space occupied by a bicycle and rider is relatively modest. Generally, bicycles are between 24 and 30 inches wide from one end of the handlebars to the other. An adult tricycle or a bicycle trailer, on the other hand, is approximately 32 to 40 inches wide. The length of a bicycle is approximately 70 inches; with a trailer, the length grows to 102 to 110 inches (fig. 1-2).

Figure 1-2: Common dimensions for bicycles, tricycles, and bikes with trailers.

How are these dimensions used in practical applications? One example would be in determining the width of a bicycle lane or a shared-use path. Clearly, such facilities must be wide enough to accommodate a standard bicycle or an adult tricycle. Another example would be in determining the length of a median refuge on an arterial street.

The height of an adult rider on a bicycle is given as 60 to 88 inches. This height takes into consideration the possibility that the bicyclist may be riding while standing up. Generally, adult riders are between 5 and 6 feet high while sitting on the saddle.

Figure 1-3: The necessary space envelope for a bicyclist includes more than the width of the bike and rider; it includes operating space and lateral clearance to obstacles.

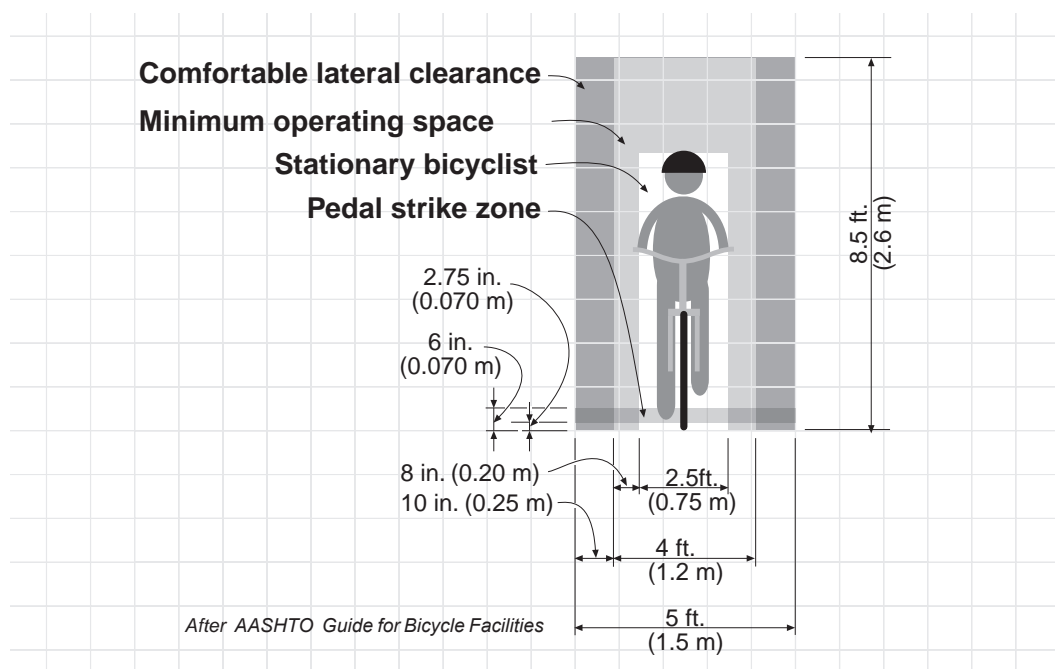

Figure 1-4: This shared-use path includes a number of hazards intruding into the necessary “comfortable lateral clearance.”



Maneuvering allowances: While the dimensions identified in Figure 1-2 give the physical space typically occupied by the bicycle and rider, the bicycle in motion requires additional space. The *minimum operating space* (Fig. 1-3) allows for the balancing and related weaving required to keep a bicycle upright and moving forward. While the *minimum operating space* accounts for a bicyclist’s wobbling side to side, additional space is needed as a “shy distance” from obstacles (fig. 1-4). This *comfortable lateral clearance* provides a buffer to curbs, posts, and other potential hazards. Combining these allowances and the width of an average bicycle gives a 5-foot space envelope within which a bicyclist may ride without undue difficulty.

An additional clearance factor should be taken into account, however, and this may be called the *pedal strike zone*. A bicyclist riding close to a low curb may strike a pedal on the top of that curb. As the pedal travels down and backward in its circular motion, the rear wheel may lift off the ground causing a crash. Low obstacles of this nature should be kept away from the likely path of bicyclists.

Bicycling speeds: In determining design speeds for bicycle facilities, it is important to consider the average speeds of typical bicyclists, as well as other likely users. Studies have shown that the normal range for casual bicyclists is between 7 and 15mph; the average speed is between 10 and 11mph (fig. 1-5). However, these studies may not account for the growing number of fitness riders, whose speeds may easily range from 15 to 20mph on the flat to 35 to 45mph on downgrades.

Turning radii: An important consideration in setting bicycle path curve radii, particularly those on downgrades is the effects of speed on turning ability. According to *Bicycling Science* (Witt & Wilson, 1989), above 9 to 13mph, a bicyclist cannot turn the handlebars more than a few degrees to either side without losing control. For this reason, decreasing radius curves, for example, can be particularly difficult for most bicyclists to negotiate, especially on downhills.

Further, while bicyclists, unlike motorists, can lean into turns, few riders are comfortable leaning at angles above 5 to 10 degrees. To do



Figure 1-5: Typical speeds range from 7 to 15mph for average bicyclists.



Figure 1-6: Leaning is a necessary part of turning a bicycle. But few riders know how to lean well over without hitting a pedal or sliding out.

so puts the inexperienced rider at risk of either sliding out or hitting the inside pedal on the pavement. As a result of these factors, bike path curve radii, for example, should be designed in a conservative manner.

Figure 1-7: Foul weather, combined with equipment limitations can affect a bicyclist's stopping distance and turning radius.



Stopping distance: Another critical characteristic is stopping distance. Due to differences in brake type and quality and rider skill, stopping distances for bicyclists traveling at the same speed may vary dramatically. Some bicycles are equipped with coaster brakes attached to the rear wheel hub; others use caliper brakes that act on both wheels. Further differences are found between high quality caliper brakes with special brake pads and inexpensive ones equipped with relatively slick pads.

Weather and braking: Wet weather seriously reduces the effectiveness of most bike brakes. According to *Pedal Cycle Braking Performance: Effects of Brake Block and Rim Design* (Watt, TRRL, 1980), some common bicycle brakes take over four times as far to stop in the rain as they do under dry conditions. Further, bikes equipped with aluminum alloy rims stop between two and four times as quickly in rain as similar bikes equipped with steel rims. As a result, stopping sight distances are important factors to consider, particularly when designing curves and intersections on separate trail systems.

Bicyclist abilities: Compounding these factors are the varying abilities of the riders themselves. Skilled bicyclists, for example, can stop far more quickly than can unskilled riders, because they know how to effectively use their front caliper brakes. Less skilled riders, on the other hand, often rely primarily on their rear brakes, dramatically increasing their stopping distances. Cornering ability varies widely, as does the ability to climb hills or descend safely, among others.

For more detailed discussion of these topics, see the references mentioned above.

1.2 Design options

The rest of this manual describes specific design features and approaches for accommodating bicyclists both on- and off-road. The primary topics covered include:

- *Basic roadway improvements*
- *Bicycle lanes*
- *Shared-use paths*



Figure 2-1: Many low-volume residential streets need only the most basic improvements to make them more rideable.



2. Basic Roadway Improvements

The street system provides the basic network for bicycle travel. Other elements (e.g., bike lanes and paths) supplement this system. To make most streets work for bicyclists, basic improvements may be needed. Such things as safe railroad crossings, traffic signals that work for bicyclists, and street networks that connect benefit bicyclists and make more bicycle trips possible and likely.

2.1 Roadway types

While the most basic improvements are appropriate for all categories of street, some improvements are most appropriate for certain categories. In a typical community, streets types range from quiet residential streets, to minor collector streets, to major arterials, and highways or expressways.

2.1.1 Residential streets

On quiet residential streets with little traffic and slow speeds (fig. 2-1), bicyclists and motorists can generally co-exist with little difficulty. Such streets seldom need bike lanes. Only the most basic improvements may be required, for instance:

- *bicycle-safe drainage grates*
- *proper sight distance at intersections*
- *smooth pavement and proper maintenance*

One additional factor that may need attention is connectivity. Providing bicycle linkages between residential streets and nearby commercial areas or adjacent neighborhoods can significantly improve bicycling conditions. In many communi-

Figure 2-2: Long blocks and a lack of connectivity make trips longer and discourage bicycling for purposeful trips.

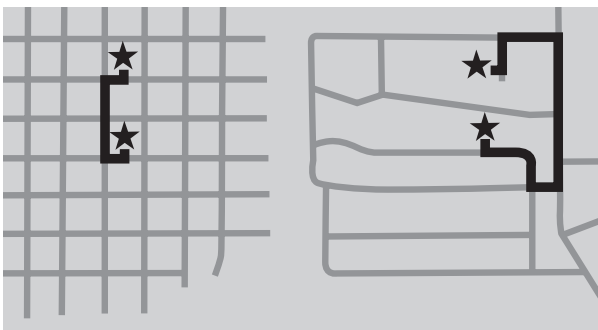

ties, newer parts of town tend to have discontinuous street networks that require bicyclists, pedestrians, and motorists to travel a long distance to get to a nearby destination (fig. 2-2) and also force bicyclists onto busier streets than necessary.

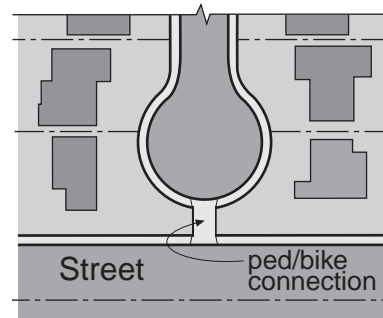

Figure 2-3: Bicycle-pedestrian connections like that shown can provide valuable short cuts. (after Mesa, AZ subdivision regulations)

Since most bicycle and pedestrian trips are short, such discontinuities can discourage bicycling and walking. Improving connections where possible can help solve this problem (fig. 2-3).

On residential streets impacted by excessive through traffic and speeding motorists — or both — traffic calming measures may be necessary. These are described in Section 2.10, but the basics include features designed to slow motorists down and those designed to divert or discourage through traffic. Also see AASHTO's *Guide for the Development of Bicycle Facilities* for information on bicycle boulevards.



Figure 2-4: Residential streets may require traffic calming measures like this traffic circle. However, designs should not endanger or discourage bicyclists.

Typical approaches include street closures, small traffic circles (fig. 2-4), chicanes, and speed humps. Traffic calming measures should be designed with bicyclists clearly in mind. In general, they should not hamper bicycling traffic and they should not create new bicycle hazards.

2.1.2 Collector streets

Collector streets typically connect local residential streets to the major roads in a community. As a result, in many areas (see the right image in fig. 2-2), the collector streets are the only ways to cross arterial streets. Even if local streets intersect the arterials, they seldom have signals to create breaks in traffic.

Therefore, in addition to the bicycle-safe grates, proper sight distance, and smooth pavement mentioned previously, other improvements should be considered for collector streets:

- *bicycle-safe railroad crossings*
- *bicycle-actuated traffic signals*
- *wide outside traffic lanes or bicycle lanes*
- *bike lanes or shoulders on bridges and underpasses*

Note: Photos are categorized by their content:

- Positive example
- Special case example
- Not recommended.

Figure 2-4: Collector streets like this one typically carry lower traffic volumes and have lower speeds than arterial streets. As a result, many bicyclists feel more comfortable using them.



The importance of collector streets for bicyclists is worth keeping in mind, particularly when considering plans for new subdivisions and commercial areas. In some communities, arterial streets are laid out on a one-mile grid, with collectors on the half mile. As a result, less-experienced bicyclists can get around without having to use busy main thoroughfares (fig. 2-4). If the pattern of collector street connectivity is broken, however, these bicyclists will find their options limited and their access restricted.

On-street parking: Most new collector streets built within urban areas are constructed with parking for both sides. However, off-street parking is plentiful in new developments, and, as a result, very little "spill-over parking" occurs on the street. This typically leaves a very wide street for bicycle and motor vehicle use (fig. 2-5). On the other hand, if a street is being used consistently for parking, there may not be enough space to provide for bicycle lanes or wide parking lanes.

Figure 2-5: In some areas with plenty of off-street parking, collectors are designed for on-street parking with extra space for bicycles. This may result in excessive width and potentially high traffic speeds.



Planners should be aware of this situation when evaluating and planning for collector streets. If additional width is built into collector streets to accommodate bicyclists and parked cars, but the street is rarely being parked on, the excessive width may result in high traffic speeds.

When transportation planners created bicycle plans for metro areas in the mid-1990's, several reported a mismatch between what bicyclists were telling them about collector street bicycling conditions and what would be expected, based upon accepted standards. Their initial analysis told them the streets were narrow and uncomfortable for bicycling. But the bicyclists told them there was plenty of space. The reason for this difference in perspective was the lack of parked cars on the streets.

If only sporadic parking is expected, new collector streets should be considered for one-side parking. Similarly, restriping existing collector streets to restrict parking to one side may improve conditions for bicyclists who have to otherwise move left around the occasional parked car.



Figure 2-6: A major suburban arterial street with 45mph speeds and high volumes. Many bicyclists would see this as a hostile bicycling environment.

2.1.3 Arterial streets

Arterial streets typically carry much of a community's traffic load, particularly for trips involving cross-town or inter-city travel. In addition, major businesses and institutions are often found along arterial streets. As a result, arterial streets are often the busiest roads around (fig. 2-6).

In a community's center, however, traffic speeds tend to be lower than in the suburbs and this may make downtown streets easier for bicycling (fig.

Figure 2-7: A downtown arterial street typically has lower traffic speeds than an arterial street in the suburbs.



2-7). Downtown, speed limits may be 25 or 30mph, while in the suburbs, arterial streets may be signed for 45 or, in some cases, 55mph.

Common improvements recommended for arterial streets include:

- *bicycle lanes, wide outside lanes, or shoulders;*
- *urban (instead of rural) highway interchange designs;*
- *shoulders or bicycle lanes on bridges and underpasses;*

2.1.4 Rural highways

Rural highways (fig. 2-8) are most useful for long-distance touring and recreational bicycling. Busy multi-lane highways are much less popular than lower volume highways and town roads, however. Interstate highways and freeways typically do not allow bicyclists.

Figure 2-8: Basic paved shoulders are often the only improvements needed to make rural roads more bicycle-friendly.



To help determine if paved shoulders are necessary for rural highways, a methodology or rating index should be used whenever traffic volumes on town and county roads increase beyond approximately 500 vehicles per day. Many counties and communities use the Wisconsin Bike Map methodology. This model rates roadways for their bicycle compatibility using traffic volumes and the width of the roadway as the two primary factors. The Bike Map methodology is available from WisDOT upon request. [Table 2-1 in section 2.6.2 presents the concept in brief.]

On quiet country roads, little improvement is necessary to create excellent bicycling routes (fig. 2-9). Examples include town roads and many county trunk highways. State trunk highways and some county trunk highways, however, tend to have more traffic and a higher percentage of trucks. As a result, they are often improved with the addition of paved shoulders (sec. 2.6).



Figure 2-9: Many low-volume country roads need few improvements in order to serve bicyclists well.

Rural roads near growing communities often suffer from a mismatch of design and current traffic loads. While they may have been designed for farm-to-market or rural recreational purposes, new development can overload them with suburban commute and personal business trips. These roads should get priority attention.

Also see AASHTO's *Guide for the Development of Bicycle Facilities* for information on how to retrofit bicycle facilities on existing streets and highways including strategies on how to allocate existing roadway space differently to accommodate various bicycle facilities. It includes the consideration of reducing the number of travel lanes and lane widths, as well as finding additional space by using different vehicle parking schemes.



2.2 Pavement quality

Automobile suspensions can compensate for surface roughness and potholes and their wide tires can span cracks. But most bicycles, with their relatively narrow tires and lack of suspension, have difficulty handling such hazards (fig. 2-10).

Concrete slabs or asphalt overlays with gaps parallel to the direction of travel can trap or divert a bicycle wheel and cause loss of control. Holes and bumps can cause bicyclists to swerve into the path of motor vehicle traffic. To the extent practicable, pavement surfaces should be free of irregularities.

The right lane or shoulder should generally be uniform in width. While skilled bicyclists tend to guide off the lane stripe and ride a predictable straight line, many riders move right or left depending on the width of the lane or presence of shoulders. A road which varies greatly in width encourages such unpredictable behavior.

Figure 2-10 (above): Bad pavement edges create hazards for bicyclists.

Figure 2-11 (right): Gravel from an unpaved side road is dragged up onto an otherwise adequate shoulder, reducing the amount of space available for bicycling.



On older pavements it may be necessary to fill joints, adjust utility covers or, in extreme cases, overlay the pavement to make it suitable for bicycling. See Drainage Grates (sec. 2.6) for advice on grates and utility covers.

When *new pavement overlays* are added to curbed roadway sections, the old pavement should be milled, if necessary, to allow the new asphalt to meet the gutter pan smoothly. Failure to feather the new overlay into the existing pavement can result in a hazardous longitudinal lip at the edge of the new asphalt (fig. 2-12).

Paving over a concrete gutter and then considering it usable for bicyclists is generally not satisfactory for Wisconsin climates for several reasons: (1) the joint line will probably come through the new asphalt, causing a longitudinal crack. (2) Paving to the curb may affect the drainage and lower the effective height of the curb. (3) The bicyclist will still need to shy away from the curb.

Chip sealing a road extends the life of the pavement at relatively low cost (fig. 2-13). Chip sealing can fill joints and smooth out roadway imperfections. However, when applying chip seal coats to existing streets, removal of excess gravel at the earliest possible convenience is important.

Since passing motor traffic sweeps the gravel off to the side of the road, it tends to collect in piles deep enough to cause bicyclists to crash. For this reason, bicyclists will often ride in the area cleared by motorists' tires.

Roadway patching typically follows underground utility work or it may be done to repair potholes and other problems. Pavement replacement should be flush with surrounding pavement, including the adjacent concrete gutter. If possible, longitudinal joints should be located away from the bicyclist's typical path. In addition, patches should not fail within a year.



Figure 2-12 (top): A rough edge created by not feathering the overlay into the curb.

Figure 2-13 (bottom): chip seal is often used to extend the life of a roadway.

Figure 2-14: This drainage grate has two main problems. First, its parallel bars and slots can trap a bike wheel. Second, it's located in a likely path of a turning bicyclist.



2.3 Drainage grates and utility covers

Drainage grate inlets and utility covers can be hazards for bicyclists (fig. 2-14). Typical problems with grates and covers include:

- drainage grate slots that can trap or divert bicycle wheels
- slippery utility cover or grate surfaces
- surfaces not flush with the roadway
- collection of debris and water
- grates placed in driveways or curb cuts

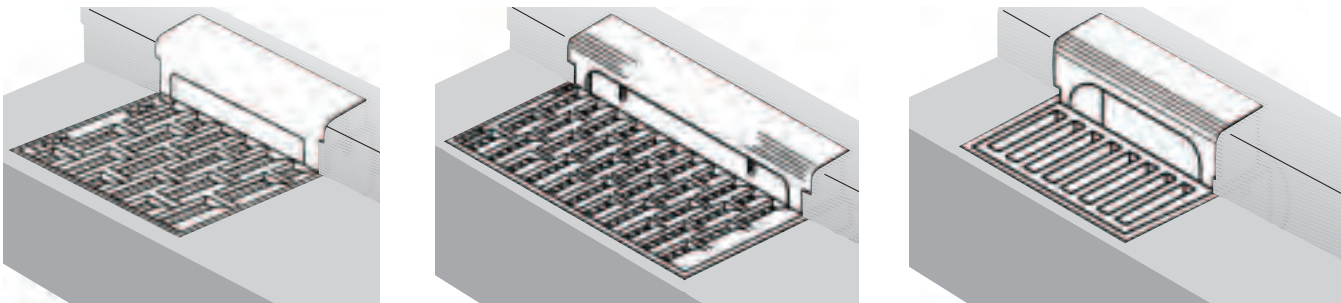

Figure 2-15: Examples of WisDOT standard bicycle-safe grates: Type A, H, and Z (left to right)

2.3.1 Grate type

The standard inlet covers used by WisDOT (fig. 2-15) are considered bicycle-safe. The inlet covers which are narrow and therefore encroach the least into a bicycle curb lane are Types “A,” “H,” “HM,” “R,” and “Z.” These inlet cover types must be used for new construction/reconstruction projects and also as replacement covers for 3R improvements, providing they have the necessary hydraulic capacity.

2.3.2 Grate or utility cover location

To the extent possible, drainage grates and utility covers should be kept out of the typical bicyclists' likely path (see Fig. 2-16). In many cases, however, grates and covers are located near the right side of the roadway, where most bicyclists ride.

To reduce the potential for problems, grates should be close to the curb and should not extend farther into the roadway than is necessary; the grate should be within the gutter pan.

Where roadway space is limited, the curb may be offset at the grate location (see Fig. 2-18). Note that the total width of curb and gutter in this example from Madison does not change. The 1-ft. curb head narrows to 6-in. to allow for a Type A drain. In addition, this approach shifts the gutter pan/roadway joint line closer to the curb and farther from the bicyclist's typical path.

At intersections, the Americans with Disabilities Act. Guidance recommends placing drainage grates outside crosswalk or curb ramp locations to limit the drainage across the ramps. This also improves the safety of wheelchair users and those with visual impairments (Fig. 2-17). However, locating grates between the crosswalks would put them where turning bicyclists are likely to be closest to the curb.

If possible, grates should be located within the gutter pan just before the crosswalks. If they must be located between the crosswalks, a curb inlet should be used.

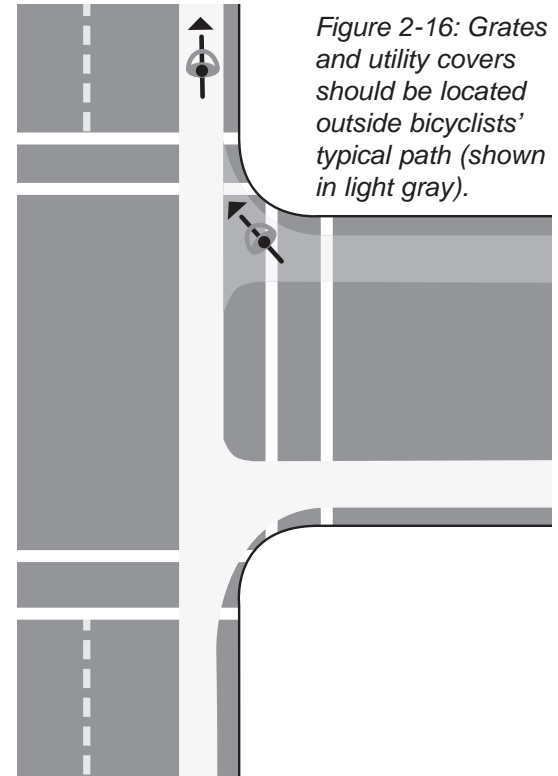
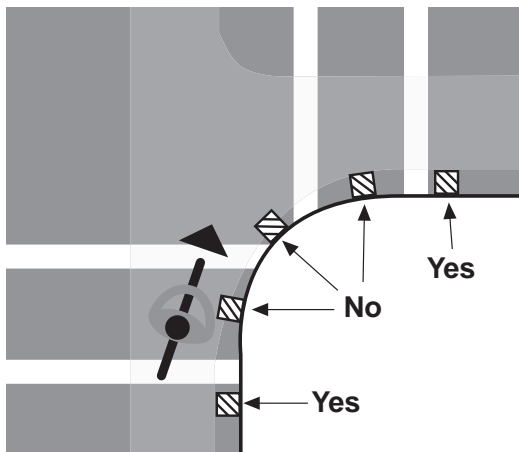

Figure 2-16: Grates and utility covers should be located outside bicyclists' typical path (shown in light gray).



Figure 2-17 (left): Locate drainage grates before the crosswalks and corners to reduce the hazards for wheelchair users and bicyclists.

Figure 2-18 (right): Offsetting the grate into the curbface allows for the use of a 1-ft gutter pan, reduces the effective width of the grate, and moves the longitudinal joint away from the bicyclist's path.



Figure 2-19: Depressed or raised grates can be hazardous, regardless of type.

Figure 2-20: In some cases, the roadway may need to be ground to match the height of the grate or utility cover. (after Montana Public Works Standard Specifications, 1988)

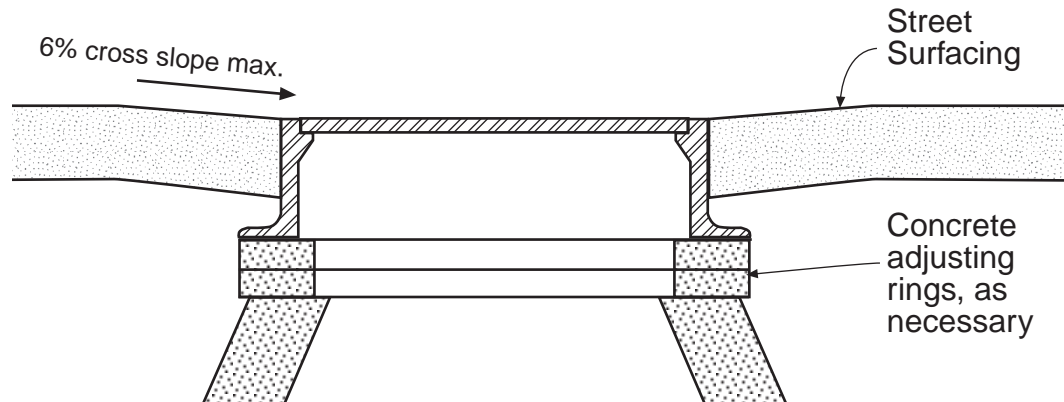

2.3.4 Temporary measures

In general, temporary measures are much less satisfactory than simply replacing a dangerous drainage grate with a safe one. Field welding straps to a grate is not recommended (fig. 2-21). It can be costly and snow plows may pull the straps loose, causing a hazard. Another temporary measure — striping a hazard marker around a dangerous grate — is also generally unsatisfactory. In low-light conditions, the stripe may be hard to see and the paint may wear off quickly.

Figure 2-21: Temporary measures, like welded straps, may be more costly in the long run.



2.3.3 Grate or utility cover elevation

Whenever a roadway is resurfaced, grates and utility covers should be adjusted flush with the new surface (fig. 2-19) and should never be higher than the roadway. If the height is still below the roadway level after adjustment, the pavement should be tapered to meet (fig. 2-20), particularly if the height difference is more than 1/4 in. (6 mm)

Note: grates with bars perpendicular to the roadway must not be placed at curb cuts, as wheelchair wheels could get caught.

2.4 Corner sight lines

One serious concern for bicyclists is visibility at intersections (fig. 2-22). If sight lines are blocked by vegetation, fences, or other obstructions, motorists may not be able to see bicyclists, and vice versa. This is a particular concern with young bicyclists riding in neighborhoods and is a known factor in bicycle/motor vehicle crashes.



Figure 2-22: Sight obstructions can lead to bicycle-motor vehicle crashes.

Typically, at intersections of streets of different functional classifications (e.g., local vs. collector or collector vs. arterial), sight distances are considered for the driver entering from the lower classification roadway. The assumption is that such a driver would face a traffic control device (e.g., a stop sign).

For neighborhood streets, it is equally important, however, that a driver on the superior roadway be able to see — and avoid — young bicyclists approaching on the lower classification roadway. Even so, unless steep grades are a factor, young bicyclists are unlikely to approach fast enough to warrant clear sight triangles in excess of those otherwise considered necessary. To reduce sight obstruction hazards posed for both bicyclists and motorists, agencies should consider developing active sight triangle improvement programs.

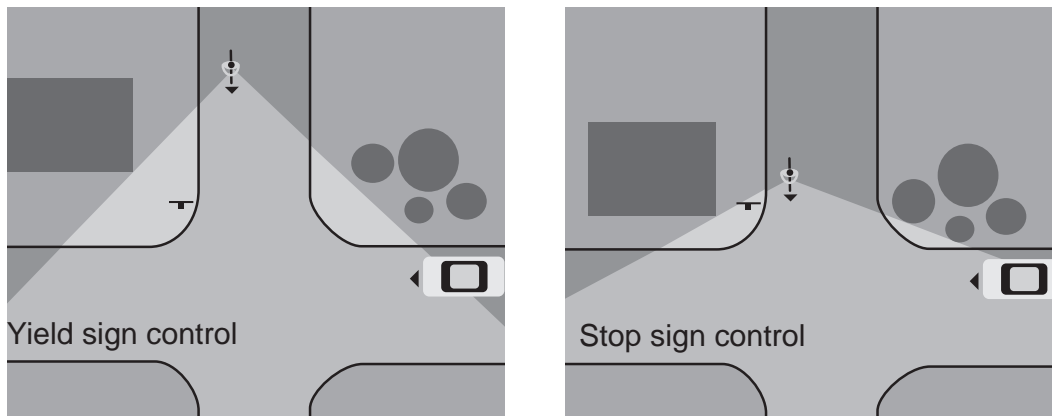

Figure 2-23: Protecting corner sight lines is an important safety task.

Figure 2-24: A wide outside lane can provide room for bicyclists and motorists to share an arterial or collector street lane.



2.5 Wide outside lanes

Where there is insufficient room to install bicycle lanes on urban and suburban arterial and collector streets, creating wide outside travel lanes can help accommodate both bicycles and motor vehicles (fig. 2-24). It is Wisconsin Department of Transportation policy to give strong consideration to bicycle lanes and wide outside travel lanes on all urban cross-section projects.

Figure 2-25: A standard “wide outside lane” configuration showing a 14ft (4.2m) outside lane and a 12ft (3.6m) inside lane.

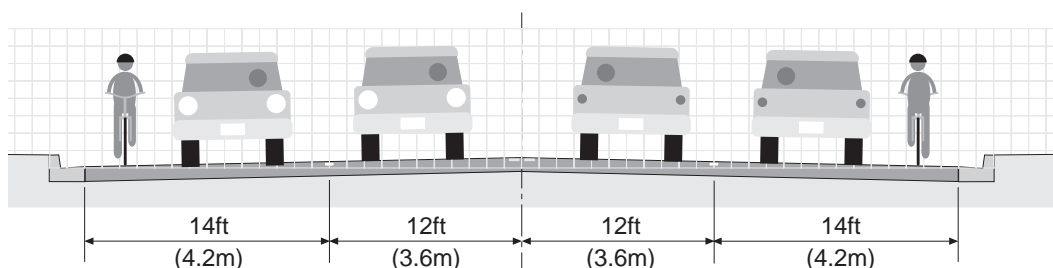

A useable lane width of at least 14 ft (4.2 m), not including the standard 2-ft. (0.6 m) gutter pan, is needed for a motor vehicle and bicycle to operate side by side (fig. 2-25). As an alternative, a lane width of 15 ft (4.5 m) may be used with a 1-ft. (0.3 m) gutter pan and 1 ft. curb head (see fig. 2-16). This option provides extra effective width for the bicyclist since it moves the joint line between the gutter pan and roadway closer to the curb face. In really tight right-of-way situations, a lane width of 14 ft (4.2 m) not including a narrow 1-ft. (0.3 m) gutter pan, may be acceptable.

An edge marking may be used to stripe an 11 or 12 ft (3.3 m or 3.6 m) travel lane, leaving the remainder for a 4 or 5 ft curb off-set. Such “shoulders” are similar to those provided on rural roads and highways (see Sec. 2.6), although they typically have gutters.

In some instances, widths greater than 15 ft (4.5m) can encourage the operation of two motor vehicles in one lane, although this is not a common problem in Wisconsin. This is most likely to occur near intersections with heavy turn volumes at times of maximum congestion and lowest speeds. Such conditions may reflect a need to consider modifications to the intersection. On streets with dedicated right-turn lanes, the right-most through lane should be widened.

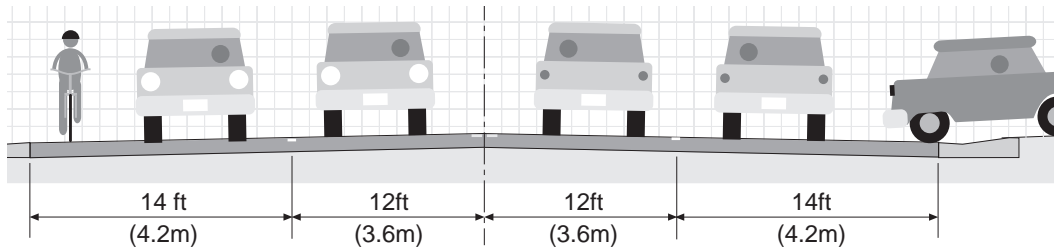

Figure 2-26: Wide outside lanes provide clearance for motorists entering driveways or cross streets or waiting to leave them.

Wide outside lanes have numerous benefits in addition to providing space for bicyclists and motorists to share. They improve roadway capacity by reducing conflicts between motorists traveling straight and those turning into or out of driveways and cross streets. And they provide space for temporary storage of snow and disabled motor vehicles.

If on-street parking is provided along with the wide outside travel lane, the parking lane should be standard width. Narrowing a parking lane to provide the space for bicyclists may or may not encourage motorists to park closer to the curb (fig. 2-27). If a standard travel lane is used, a total of 12 ft (3.6 m) of combined parking/bicycling space is highly recommended for this type of shared use.

And an opening car door may take up the extra space in the travel lane. As a result, the effective width of the outside travel lane in such cases may not be as great as the measured width.



Figure 2-27: Narrowing the parking lane by adding a white line will not necessarily create extra space for bicyclists.

Note: wide lanes are not suggested for quiet residential streets, where they are unnecessary, increase construction costs, and may increase “cut-through” traffic speeds.

Figure 2-28: On an arterial street with narrow right-hand travel lanes, drivers will either pass bicyclists in close quarters or shift into the adjacent lane to pass.



2.5.1 Retrofitting an existing roadway

While providing wide outside lanes on new construction may be preferred, it is also possible to retrofit existing roadways by restriping. Typically, lane striping is best altered when the roadway receives a new pavement overlay. In this way, old striping patterns will not confuse motorists or bicyclists. However, where snow plows and road sanding wear away lane stripes, it may be possible to restripe to a new configuration without new paving.

Figure 2-29: One way to gain extra width in the outside lane is to shift the lane striping after a pavement overlay.



The extra width may be gained in several ways (fig. 2-29). Lane striping may be shifted to give a narrower inside lane and a 14 ft wide outside lane (fig. 2-30(b)). This should be done when the road is resurfaced or after a hard winter's sanding and plowing have erased the existing markings. On a concrete street with integral curb and gutter (fig. 2-30(b) right), there is no joint line to worry about. If curb and gutter are to be replaced, the gutter pan may be reduced to 1 ft, adding 1 ft to the curb head with an inset inlet grate (fig. 2-30(c) and 2.18). This approach provides more stability for the curb, makes it more snow plow-resistant, and makes it easier to mow adjacent grass.

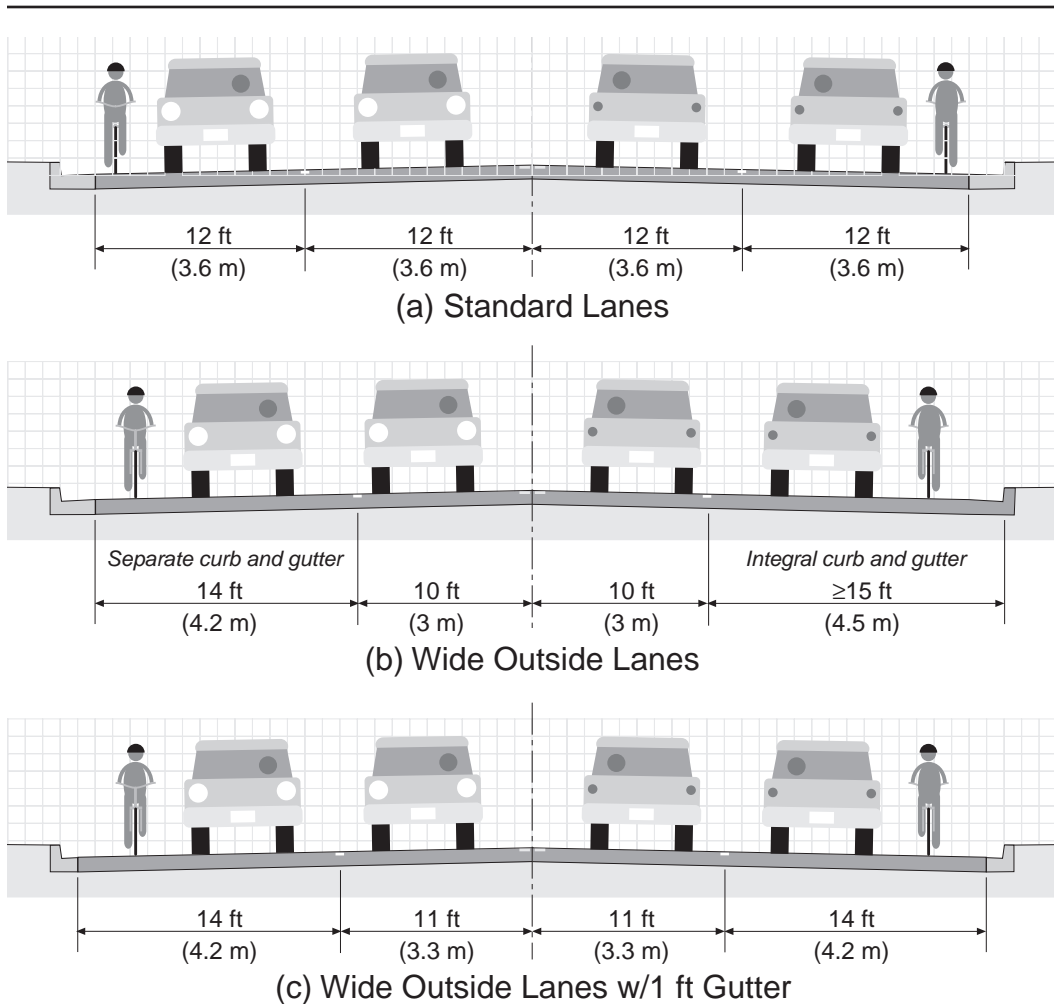

Figure 2-30: Shifting lane striping is one way to create a wider outside lane. With a concrete street with integral curb and gutter, there is no joint line that can possibly endanger bicyclists. If the curb and gutter are being replaced, extra space may be gained by reducing the gutter pan width to 1 ft.

Figure 2-31: Designers replaced 4 through lanes on this narrow road with 2 through lanes, a center turn lane, and space for bicyclists.

Another approach may be to eliminate a travel lane or parking lane (fig. 2-31). Using a “road diets” approach, it may be possible to install a left turn lane or raised median and still provide sufficient capacity. On some such roadways, this approach has been used to create bicycle lanes as well.

If the roadway is scheduled for widening, planning for extra space for bicyclists should be included from the beginning. In such instances, bicycle lanes would be preferred over wide outside lanes but physical or financial constraints may govern the outcome.

Travel lanes less than 14 ft. may use shared lane markings or “bicycles may use full lane” signs, see the MUTCD for details.



Figure 2-32: Adequate paved shoulders on rural roads provide clearance between bicyclists and passing motorists. In this particular instance, the shoulder is marked as a bike lane, since it links a state park entrance and a state trail.



2.6 Paved shoulders

On rural highways, smoothly paved shoulders are preferred by many bicyclists. Shoulders provide clearance between bicyclists and high-speed motor vehicle traffic and they reduce the “wind blast” effect of passing trucks. In addition, there are other reasons for considering shoulders.

According to *The Policy on Geometric Design of Highways and Streets* (AASHTO, 2001), paved or stabilized shoulders provide:

- *usable area for vehicles to pull onto during emergencies;*
- *elimination of rutting adjacent to the edge of travel lane;*
- *adequate cross slope for drainage of roadway;*
- *reduced maintenance; and*
- *lateral support for roadway base and surface course.*

Figure 2-33: Very low volume rural roads seldom require paved shoulders for bicyclists.



2.6.1 Low-volume rural roads

Very-low-volume rural roads (i.e., those with ADT's below 700) seldom require special provisions like paved shoulders for bicyclists (fig. 2-33). A motorist needing to move left to pass a bicyclist is unlikely to face oncoming traffic and may simply shift over. And bicyclists can ride far enough from the pavement edge to avoid hazards.

In special cases, shoulders may be beneficial (e.g., on a town road connecting a school and a nearby rural neighborhood or a hilly low-volume highway serving truck traffic). Generally, on busier rural routes, like

State Trunk Highways, some County Trunk Highways, and connectors to important destinations, shoulders of sufficient width become critically important. In addition, paved shoulders should be seriously considered where low-volume town roads are being overtaken by new suburban development (fig. 2-34)



Figure 2-34: Paved shoulders are most helpful in developing areas. In such cases, new land uses typically lead to higher traffic levels, often rendering old rural roads inadequate and hazardous for bicyclists. Note temporary shoulders.

2.6.2 Overall shoulder width

The overall shoulder width may include a paved and an unpaved portion. While the paved portion may be suitable for bicycle use, the unpaved portion provides support for the pavement edge and may serve as an area for stopped traffic. This latter area should be stable and have a relatively smooth surface.

In general, the total shoulder width should be between 6 ft and 8 ft. (1.8 m - 2.4 m). The paved portion will be between 3 ft (0.9 m) and 8 ft (2.4 m), depending on traffic conditions (see following section). Often, the standard shoulder requirements discussed in WisDOT Facilities Development Manual (FDM) Procedure 11-15-1 will take priority.

In retrofit situations or constrained conditions, the most desirable solution may be impossible to achieve. In these cases, providing as much shoulder width as possible will benefit bicyclists. On reconstruction projects, it may be possible to re-ditch and provide adequately wide shoulders.

2.6.3 Basic recommendations

Table 2.1 provides shoulder paving requirements to accommodate bicycles on rural two-lane State Trunk Highways. Where shoulder bikeways are provided on four-lane divided expressways, the paved shoulder width should be 8 ft. (2.4 m). Where a bike route is planned or located on a County Trunk Highway or town road, the paved width, if any, should be determined by the local government, using the values in Table 2.1 (see following page).

TABLE 2.1: Rural Two-Lane State Trunk Highway Paved Shoulder Width Requirements to Accommodate Bicycles

Motor Vehicle ADT	Bicycle ADT (or Plan inclusion)	
	0 - 24	≥25 ⁽¹⁾
Under 700	0 ⁽²⁾	0 ⁽²⁾
700 - 1500	0-3 ft (0-0.9m) ⁽²⁾	4 ft (1.2 m) ⁽³⁾
1501 - 3500	3 ft (0.9 m) ⁽²⁾	5 & 6 ft (1.5 m) ⁽²⁾⁽⁵⁾
≥3501 ⁽⁴⁾	4 ft ⁽²⁾	5 ft (1.5 m) ⁽²⁾⁽⁴⁾

(1) 25 bicycles per day (existing or expected) OR recommended in an adopted transportation plan.

(2) See Figure 5 of Facilities Development Manual (FDM) Procedure 11-15-1 for other shoulder paving standards not related to bicycles. For roadways that do not meet the Bicycle ADT requirement, a 3 ft. (0.9 m) shoulder is typically provided. However, for roadways with ADTs over 3500, a 4 ft. (1.2 m) paved shoulder is highly recommended.

(3) 3 ft. (0.9 m) acceptable where shoulder widths are not being widened and/or ADT is close to bottom of range.

(4) When ADTs exceed 4500, a 6ft paved shoulder is advisable.

(5) A 6 ft. paved shoulder may be highly desirable for maintenance purposes since this class calls for 6 ft. gravel shoulders. Full width shoulder paving is often preferred over leaving only 1 ft. of gravel shoulder.

While Table 2.1 provides general guidance, more detailed analysis should be considered when preparing a bicycle plan or where specific roadway conditions are more complicated than normal. To this end, the Department has produced several reports that should be of assistance:

Resources for Planning Rural Bicycle Routes

The WisDOT report *Planning for Rural Bicycle Routes* (Van Valkenburg, 1993) provides a methodology for evaluating the most important characteristics of rural roadways for bicyclists (i.e., traffic volume, percent of truck traffic, percent of no-passing zones, and paved width). Designers and planners are encouraged to use this report as a basic reference for evaluating the need for bicycle improvements on rural highways.

In addition, the forthcoming WisDOT *Guide to Rural Bicycle Facilities Planning* will provide an overview and approach for developing bicycle plans for small communities and rural areas. In this report, readers will find a step-by-step process to the planning process.

For more information, contact Tom Huber at <thomas.huber@dot.state.wi.us>

On almost all state highway projects involving reconditioning or reconstruction, paved shoulders will be part of the project. Planners and engineers need to consider the width of the paved shoulder by examining the two columns of Table 2.1. The first column represents highways with a low bicycle count and anticipated low bicycle usage, even after the shoulder paving improvement.

The second column indicates a moderate level of current or anticipated bike use (25 cyclists or more per day during peak periods). This column should be used under the following situations:

- A bicycle transportation plan (e.g., the Wisconsin Bicycle Transportation Plan, county bicycle transportation plans, or regional bicycle transportation plans) identifies a highway segment as needing wider paved shoulders;
- A bicycle use survey has determined there are 25 bicyclists per day using the highway;
- Likely bicycle traffic generators (e.g., schools, businesses, subdivisions, parks, etc.) have been built or expected to be built along the stretch of highway;
- A highway project stretches between the built-up area of a village or city and an intersecting town or county road. In most cases, bicycle travel will be heaviest between the city/village limits and the nearest town or county road. Paving wider shoulders (using column 2) for just this segment provides a safer means for bicyclists to access the town and/or county road system.

2.6.4 Guardrails and slopes

If a guardrail is provided adjacent to the shoulder, there should be between 6 ft. (1.8 m) and 8 ft. (2.4 m) between the guardrail and the travel lane (fig. 2-35). The width of the paved shoulder should be determined based on Table 2.1 or FDM Procedure 11-15-1. If wider paved shoulders are being used, paving the entire shoulder should be considered, especially if the guardrail is only 6 ft. (1.8 m) from the travel lane. Where width is constrained by topography or other factors (fig. 2-35, lower image), there should be as much paved width between the travel lane and the guardrail as practicable. In new construction, a guardrail may not be necessary if a 4:1 cross slope is provided next to the edge of the shoulder.

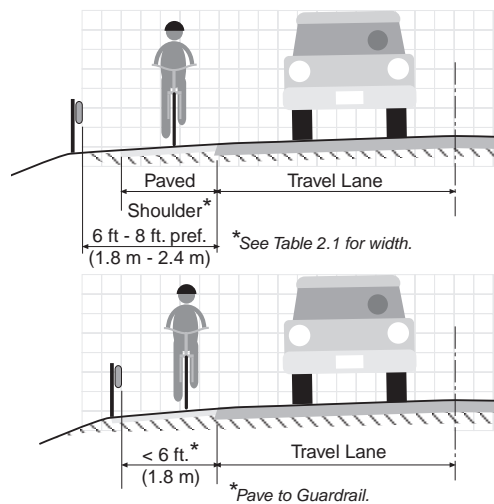

Figure 2-35: Guardrails should be offset from the travel lane by 6 ft to 8 ft (1.8 m - 2.4 m). The width of the paved shoulder should be determined by consulting Table 2.1.

2.6.5 Grades

If funding is limited, adding or improving shoulders on uphill sections first will decrease conflicts between fast motor vehicle traffic and slower bicyclists. This includes providing paved shoulders next to uphill auxiliary lanes (climbing lanes). On the downhill side, bicycles may travel almost as fast as motor vehicles, making extra space less important.

2.6.6 Pavement design and loading

Shoulders should be smoothly paved and have adequate strength and stability to support occasional motor vehicle tire loads under all weather conditions without rutting or other surface variations. The thickness of shoulder paving should be based on usual design considerations appropriate for each situation, although full-depth pavement is recommended.

2.6.7 Joints between travel lanes and shoulders

Where it is necessary to add paved shoulders to existing roadways for bicycle use, the area where bicyclists will be riding should be kept free of joint lines. If a wider shoulder (i.e., 8 ft.) is being provided, the joint line will not likely be a serious problem. However, if a narrow shoulder is being added, it is desirable to provide a minimum of 4 ft. (1.2 m) of clear width without a longitudinal joint line.

2.6.8 Unpaved driveways

At unpaved highway or driveway crossings, the highway or driveway should be paved a minimum of 15 ft. (4.5m) from the edge of the traveled way on either side of the crossing to reduce the amount of gravel being scattered along the shoulder by motor vehicles (fig. 2-36). If the unpaved highway or driveway approaches the shoulder on a descending grade, gravel will tend to scatter farther than normal. As a result, the pavement should be extended accordingly.

*Figure 2-36:
Paving into gravel
driveways or side
roads, or in this
case a stone-
surfaced state
trail, can help
keep debris from
covering the
paved shoulder.*



2.6.9 Rumble strips

Two types of rumble strips (shoulder-style rumble strips and perpendicular-style rumble strips) are used on rural roadways.

Shoulder rumble strips are not suitable as a riding surface and present a potential hazard to bicyclists (fig. 2-37). In Wisconsin, they are commonly used on freeways and expressways, and sometimes on two-lane roadways because of their effectiveness in reducing run-off the road crashes on high-speed roadways. The WisDOT FDM provides more information on rumble strips policies and designs standards.



Shoulder rumble strips should not be used if they are being proposed for the purpose of improving safety for bicyclists; their presence is more likely to cause a hazard for bicyclists than it is to enhance a "physical separation" between motorists and bicyclists. Furthermore, rumble strips should not be used unless there is at least a clear shoulder pathway available to bicyclists of 4 ft. (1.2 m) wide (or 5 ft. (1.5 m) wide if there is an obstruction such as a curb or guardrail) to the right of the rumble strip for bicycle use. (See FDM S.D.D. 13A10)

Perpendicular-style rumble strips (FDM S.D.D. 13A8 and 13A9) are more common on 2-lane roadways and are found on state, county, and town road systems. If they are required at intersection approaches, they should not continue across the paved shoulder. If a paved shoulder is not present, the right-most 18 in. to 3 ft. (0.45 m -0.9 m) of pavement should be left untreated so bicyclists may pass safely.

Figure 2-37: Continuous shoulder rumble strips provide an unsafe surface for bicycling. Gaps every 40-60 ft. that are 12 ft. long should be provided for bicyclists to safely move between the shoulder and travel lane as necessary to avoid debris, make turns, pass, etc.



Fig. 2-38: An old unused diagonal railroad crossing. The flangeway can catch and turn a bicyclist's front wheel, especially when wet, and the roughness can also cause a tumble.

2.7 Railroad crossings

Special care should be taken wherever a roadway or path crosses railroad tracks at grade. Numerous bicycle crashes have resulted from dangerous crossings. The most important crossing features for bicyclists are (1) the crossing angle and the presence of a gap on either side of the track's rail; and (2) the crossing's smoothness. Problems with both of these features are illustrated in figure 2-38.

2.7.1 Crossing angles and gaps

Railroad crossings should ideally be straight and at a 90-degree angle to the rails. The more the crossing deviates from this ideal angle, the greater is the potential for a bicyclist's front wheel to be diverted by the gap on either side of the rail — or even by the rail, itself. Crossing angles of 30 degrees or less are considered exceptionally hazardous, particularly when wet. However, if the crossing angle is less than approximately 60 degrees, remedial action should be considered.

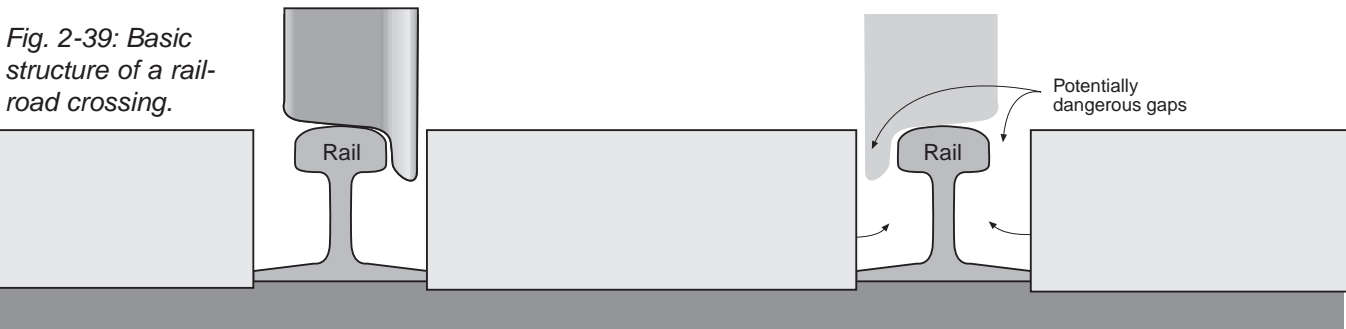

Fig. 2-39: Basic structure of a railroad crossing.

Since the gap between the side of the rail and the roadway surface is a primary source of the problem (fig. 2-39), the width of the gap should be minimized. For the gap on the outside of the rail (called the “field flangeway”), this problem can often be solved relatively easily. Fillers made of rubber or polymer are manufactured by several companies, primarily to keep water and debris out, and these can eliminate the outside gap almost entirely.

But such is not the case for the gap on the inside of the rails (fig. 2-40). This gap, called the “gauge flangeway,” must be kept open, since it is where the train wheel’s “flange” must travel. (Flanges on the inside of the train wheels keep the train on the tracks.)

To allow for this flange, Federal regulations require public crossings to have at least a 2.5 in. gauge flangeway. On some crossings, the required gap is 4 in. Currently, there is no way around this regulation. Fillers for gauge flangeways are designed to this requirement and provide space for the wheel’s flange (fig. 2-41).

While some commercially-available products fill the gauge flangeway gap completely, these may only be used in low-speed applications. Such an application might be a low-speed track in (or entering) a freight yard or manufacturing plant (fig. 2-42). At higher speeds, the filler will not compress and can derail the train.

Fig. 2-40: Federal regulations require the gauge flangeway to be a minimum of 2.5in. wide to allow for the train wheel flange.

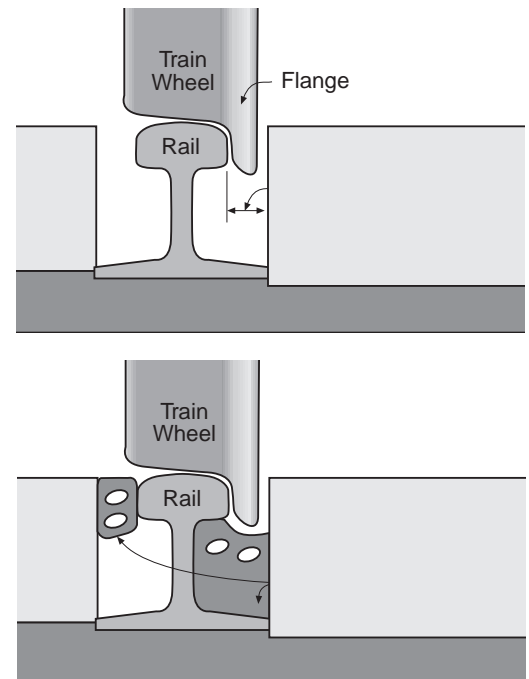

Fig. 2-41: Fillers can completely eliminate the field flangeway gap but must allow for the train wheel in the gauge flangeway.



Fig. 2-42: This rubberized crossing includes both gauge and field flangeway fillers that eliminate the gaps entirely. This combination may only be used where train speeds are very low.

Fig. 2-43: A flared approach provides a safer angle for bicyclists crossing a diagonal railroad track.



While the flangeway problem on diagonal crossings may be partially solved with fillers, in general such solutions can only address the field flangeway part of the problem. At the same time, smooth installations using concrete and/or rubber can reduce the hazard by making the crossing more level and uniform (see Sec. 2.7.2). Where right-of-way allows, another approach is to flair the roadway, bike lane, or path to allow for a more perpendicular approach (fig. 2-43 and 2-45). In

Fig. 2-44: Warning sign W11-59.3 (similar to that shown) may be used where the hazard cannot be completely eliminated.

terms of the geometrics of such a flair, there is no simple template for all applications. The appropriate crossing details will vary depending upon (1) the angle of track crossing; and (2) the width of the facility. If the set of tracks create an acute angle to the road and bike lanes are not provided, it is especially important to provide for a wide enough area on the opposite side of the tracks to allow bicyclists to gradually reestablish themselves in the travel lane.



The objective of the design should be to provide bicyclists with adequate width and distance to travel across the tracks at no less than a 60 degree angle to the tracks.

In some cases, a separate path may be necessary to provide an adequate approach angle. It is also important to take into account sign and signal location design and installation when widening the approach.

Where hazards to bicyclists cannot be avoided, appropriate signs, consistent with the MUTCD, should be installed to warn bicyclists of the danger (fig. 2-44). However, signage is no substitute for improving a crossing's safety.

2.7.2 Crossing smoothness

Regardless of angle, some crossings can damage bicycle wheels and cause a crash. This is most often the result of unevenness and poor conditions. Asphalt often deteriorates, especially near the rails, and a ridge buildup may form. Timber crossings wear down rapidly and are slippery when wet. Regular maintenance can help but to truly solve these problems, replacing the crossings with models with longer life and a more stable surface is best.

There are two primary crossing types to consider: concrete and rubber. Concrete performs well under wet conditions and, when laid with precision, provides a smooth ride. It also has a long life under heavy traffic. Rubberized crossings also provide a durable, smooth crossing, though they may not last as long as concrete and may become slippery when wet. Either is superior to the more common timber or asphalt crossings. In addition, newer combination concrete/rubber designs can provide the benefits of each type.

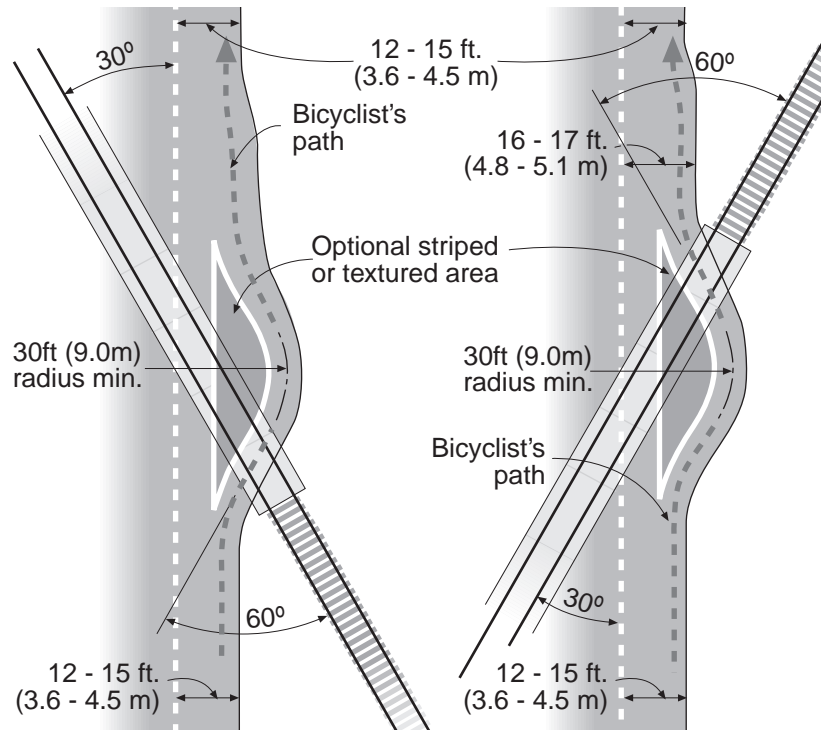

Fig. 2-45: Sample crossing designs . (after Oregon DOT State Plan)

2.7.3 Railroad/path or walkway crossings

With path/railroad crossings, the Americans with Disabilities Act is an important factor. The path surface must be level and flush with the rail top at the outer edge and between the rails, except for a maximum 2-1/2 inch gap on the inner edge of each rail to permit safe passage of the train's wheel flanges.

Figure 2-46: Traffic signal systems should be designed with bicyclists in mind. Note bicycle pavement marking for signal loop detector in through lane.



2.8 Traffic signals

There are several primary bicycle-related problems with traffic signal installations. First, many demand-actuated signal systems (those that change when traffic is detected) were not designed, installed, or maintained to detect bicycles. As a result, bicyclists may find it impossible to get a green light.

In addition, minimum green time may be inadequate at wider crossings for bicyclists to clear the intersection. As a result, bicyclists can be caught in an intersection during the change from green to red. According to national crash studies, approximately 3 percent of reported non-fatal car/bike crashes involved a bicyclist caught in a signalized intersection during a phase change. These crashes typically happen while the bicyclist crosses a multi-lane road.

2.8.1 Bicycle detection

Many traffic signals in urban areas are activated by wire detector loops buried in the roadway. An electrical current passes through the wires, setting up an electromagnetic field. When a large mass of metal (e.g., a car) passes over the loop, it interferes with the field and causes a signal to be sent to the controller box, which then changes the traffic light.

Typically, the loop is placed behind the stop line at an intersection; each through or left turn lane will have one. Often, “advance” loops are placed some distance before the intersection; these loops tell the system that a vehicle is coming and it starts the process of changing the signals.

If new loops are added to an existing roadway, the pavement cut lines left over after installation can tell bicyclists where to place their bicycles to have the best chance for detection. Many bicyclists know this trick and

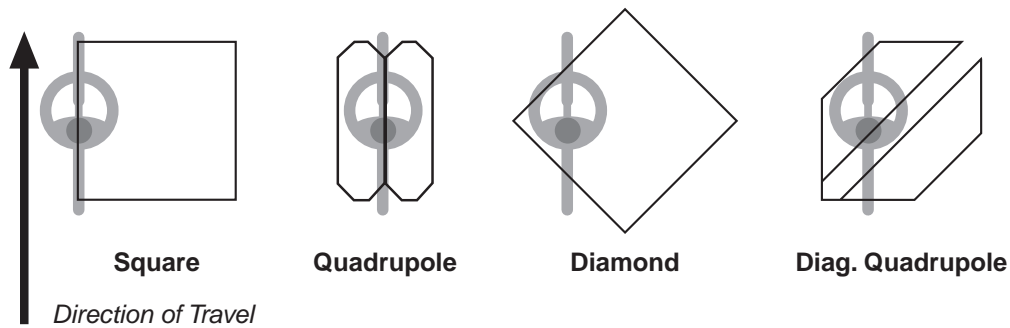

Fig. 2-47: Diagrams of various detector loop types. The lines show the locations of the wires buried under the pavement. The gray bicycle shows a preferred location for the bicycle.

use it often. However, once an asphalt overlay is added to the roadway, bicyclists can no longer identify the loop's location. As a result, they will have a harder time getting detected. This problem may be addressed through the use of pavement markings (see Sec. 2.8.2).

In general, standard *rectangular* or *square* loops are relatively insensitive to bicycles unless the bicyclist stops right over the wires. For this reason, the edge of such a loop should be identified with a pavement marking. The sensitivity may, in some cases, be adjusted to detect a bicycle without picking up motor vehicles in adjacent lanes.

Some types of detector loops have shown greater ability to detect bicycles (fig. 2-47). The *quadrapole* loop is relatively sensitive over the center wires and somewhat less sensitive over the outer wires. As a result, this loop is often used in bicycle lanes. The *diagonal quadrapole* is somewhat similar but is rotated 45 degrees to the side. This loop is relatively sensitive over its entire width and is often used on shared-use roadways or shared-use paths. Both the quadrapole and the diagonal quadrapole have been hooked up to counting equipment and used to count bicycles.

The *diamond* loop has been used with success in Wisconsin. Since bicyclists tend to ride close to the right side of the roadway, the right "point" of the diamond should be located within 6-12 in. (0.15m - 0.3m) of the edge of pavement or the gutter pan joint. A modification (fig. 2-48) of this design is also used to cover a broader area. This *extended diamond* can cover two traffic lanes.

Figure 2-48 (below): The extended diamond loop can be used over two traffic lanes.

Figure 2-49 (bottom): Other loops, including these designs, have shown promise in detecting bicycles.

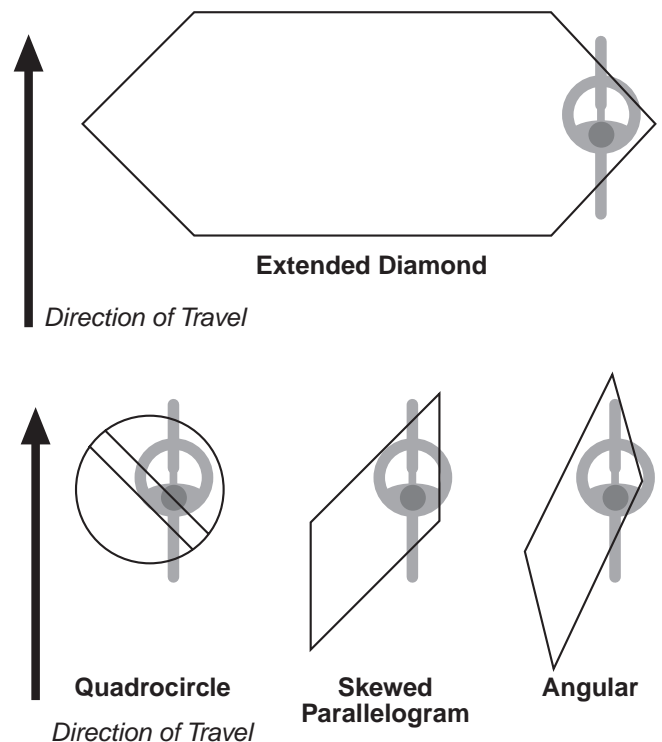

Other designs in use include the *quadrocircle*, the *skewed parallelogram* and the *angular loop* (fig. 2-49). These have also shown promise in detecting bicycles while working well for other traffic.

Detectors for traffic-actuated signals should be installed where bicyclists are likely to travel. This includes the right side of through travel lanes and the center of bicycle lanes, as well as left-turn lanes and shoulders. In addition to loop detectors, other technologies — for example, video, microwave, and infrared systems — have been used successfully in detecting bicycles.

In some situations, the use of pedestrian- or bicyclist-actuated buttons may be an acceptable alternative to the use of detectors provided they do not require bicyclists to dismount or make unsafe leaning movements. However, actuated buttons should not be considered a substitute for detectors, particularly where right turn only lanes exist.

Figure 2-50 (left)
Madison's pavement marking for loop detectors.

Figure 2-51 (right):
Suggested pavement marking in the 1999 AASHTO Guide for the Development of Bicycle Facilities.

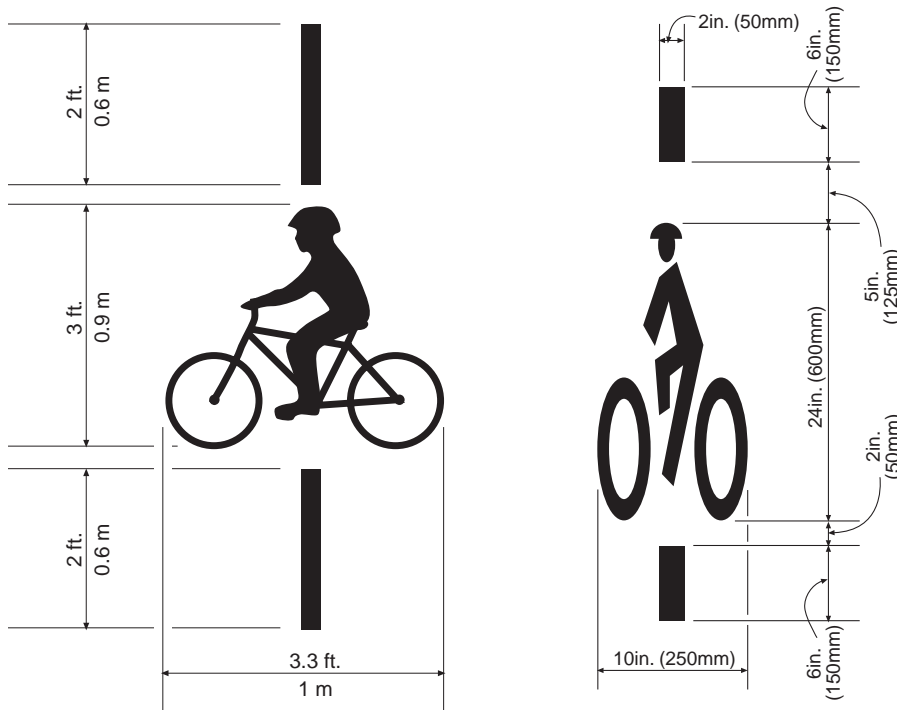

2.8.2 Signal loop markings

As suggested in Section 2.8.1, detector loops typically vary in sensitivity across their width. Further, they are seldom installed across the entire lane. For these reasons, pavement markings are often used to identify the most sensitive location for detection.

Currently, there is no standard marking in the *Manual on Uniform Traffic Control Devices*. However, figure 2-50 and figure 2-52 show the marking used in Madison; figure 2-51 shows the marking suggested in the *AASHTO Guide for the Development of Bicycle Facilities (1999)*.

Installing bicycle sensitive detectors will do more than helping bicyclists safely cross signalized intersections. By installing such detectors and marking the most sensitive locations, agencies can reinforce the principle that bicycles are vehicles and their use is a lawful and encouraged form of transportation

2.8.3 Signal timing

As a general principle, bicycles should be considered in the timing of all traffic signal cycles. Normally, a bicyclist can cross an intersection under the same signal phasing arrangement as motor vehicles. On multi-lane street crossings, special consideration should be given to ensure short clearance intervals are not used. An all-red clearance interval is often used and benefits bicyclists who need the extra time.



Figure 2-52: Close-up of Madison-style loop detector pavement marking.

With wider and wider intersection designs, the traffic engineer must pay close attention to crossing times. The desire to keep lanes full width and to add more turn lanes must be weighed against alternatives that provide protective channeling, reduced crossing width, or other designs. For these reasons, geometric designers and operations staff must work closely to create supportive bicycle crossings.

To check the clearance interval, a bicyclist's speed of 10mph (16 km/h) and a perception/reaction/braking time of 2.5 seconds should be used.

2.8.4 Programmed visibility heads

Where programmed visibility signal heads are used, they should be checked to ensure they are visible to bicyclists who are properly positioned on the road. Systems should be designed to permit the bicyclist to detect any change in traffic signals.

Figure 2-53: Bicyclists using the shoulder of a highway bridge. Note lack of debris and smooth pavement, aspects that bicyclists appreciate.



2.9 Structures

Structures like bridges and underpasses almost always provide critical links for bicycle travel (fig. 2-53). Since they are often expensive to build or modify, structures tend to be replaced less often than connecting sections of roadway. As a result, aging structures typically form bottlenecks on the overall system. Yet, they often provide the only ways past major barriers and typically connect, in some fashion, with networks of local

Figure 2-54: Lane striping was shifted to the left on this 4-lane downtown bridge to give 15-foot outside lanes and 11-ft. inside lanes.



roads on either end. For these reasons, improving a structure — or considering bicyclists’ needs when building a new one or renovating an existing one — can provide significant benefits for bicycle users for years to come.

Structures are most often associated with bridges over rivers. However, hundreds of bridges in Wisconsin are necessary to carry traffic over other highways and railroad tracks. Bicycle accommodations are important for all of these crossings whether such accommodation is provided on a road going under another highway or railroad tracks, or on a bridge over a highway or tracks.

Properly accommodating bicyclists over and under freeways is especially important since crossings are limited because of the high costs associated with these bridges. Because of the limited spacing of these crossing points for cyclists on freeways, traffic is typically heavy, thus making it that much more critical to provide additional space for bicyclists. While bridges often have some of the highest traffic counts in a community, this is not a good reason for not accommodating bicyclists on that bridge.

Bicyclists’ needs should be considered on a routine basis and on all structures (except those on highways where bicyclists are prohibited). The federal law supporting bicycle accommodations on bridges dates back to 1990 and is provided below.

Federal Law Supports Accommodating Bicyclists on Bridges

Title 23 U.S.C. §217: Bicycle Transportation and Pedestrian Walkways

(e) Bridges. – In any case where a highway bridge deck being replaced or rehabilitated with Federal financial participation is located on a highway on which bicycles are permitted to operate at each end of such bridge, and the Secretary determines that the safe accommodation of bicycles can be provided at reasonable cost* as part of such replacement or rehabilitation, then such bridge shall be so replaced or rehabilitated as to provide such safe accommodations.

** “Reasonable cost” was later defined by FHWA as to not exceed 20% of the larger project cost.*

2.9.1 Bridges

Improving a bridge for bicycle use involves analyzing four major areas of concern: (1) width constraints; (2) static obstructions; (3) surface problems; and (4) approaches.

Figure 2-55: A suburban bridge with 5-ft shoulder for bicycles, as well as a sidewalk.



Figure 2-56: Recommended widths for different structure situations.

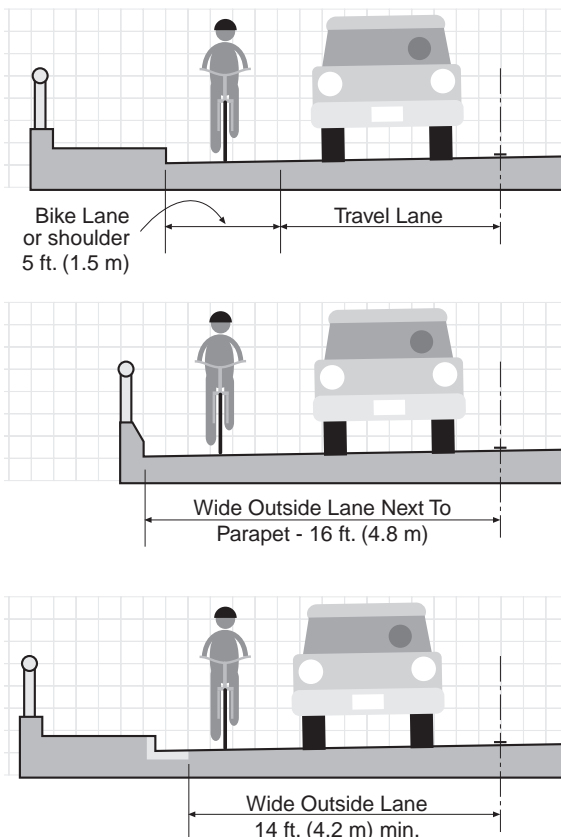

Bridge deck width: Several options are available for accommodating bicyclists on bridges or on roads that cross under bridges. In urban and suburban areas, a 5-ft striped area (unmarked or marked as bike lanes)

should be included in the basic design (fig. 2-55 and 2-56 top). At a minimum, a 4-ft striped area (not marked as a bike lane) should be provided. Alternatively, wide outside lanes can be provided as a minimum form of accommodation as long as there is at least 14 ft. of usable space in the outside lane (fig. 2-54 and fig. 2-56 bottom). Typically this translates to at least 15.5 ft. from the curb face of a sidewalk on a bridge. Sixteen feet is commonly used and should be used whenever the outside lane is next to a parapet or concrete barrier (fig. 2-56 middle).

There is an exception to the above guidelines. On low-speed urban bridges, generally with a projected traffic of less than 2,000 ADT, it is often acceptable to accommodate bicyclists in a standard travel lane.

In rural areas, speed and traffic volumes become bigger factors. On rural roadways, shoulders should be common features on all new bridges except low-volume structures. See Figures 1 through 4 of FDM 11-15-1 for the appropriate widths. Generally for all

county and state highway bridges with ADTs in excess of 750, the minimum width of shoulder areas is five feet. For state, county and town road bridges with ADTs of less than 750, bicyclists will often be sharing the travel lanes, but, since traffic is so low, bicyclists will seldom encounter auto traffic on the bridge. Minimum offsets (shy distances) from bridge parapets or sidewalks to the travel lanes on these bridges is either 2 or 3-ft.. (See section 4-16-3 for a discussion of attached bicycle/pedestrian paths on highway bridges).

Static obstructions: Bicycle-safe bridge railings should be used on bridges specifically designed to carry bicycle traffic, and on bridges where specific protection of bicyclists is deemed necessary. On highway bridges that have full-width shoulders and are not marked or signed as bikeways, the standard 32 in. (0.8 m) parapet/railing can be used.

On bridges that are signed or marked as bikeways and bicyclists are operating right next to the railing (no sidewalk, for example), a 42 in. (1 m) railing/parapet should be used as the minimum height, while 54 in. (1.35 m) is the preferred height. The higher railing/parapet height is especially important and should be used on long bridges, high bridges, and bridges having high bicyclist volumes.

Lower railings (i.e., standard heights) may be adequate for town road bridges which have low bicycle and motor vehicle volumes or on those bridges with sidewalks next to the railing.

In cases where existing railings are lower than desired, consideration should be given to retrofitting an additional bicycle railing to the top, bringing the total height to 42 or 54 inches. This is particularly useful on relatively narrow bridges, where bicyclists may be riding closer to the railing than otherwise.

Guardrails on bridge approaches should be designed with the needs of bicyclists in mind. As a general rule, a roadside barrier should be placed as far from the traveled way as conditions permit.

Figure 2-57: This bridge has a 54 in. railing that protects bicyclists from going over the top and into the river. Although a low-probability event, the consequences would be severe.



Figure 2-58: Lightweight concrete was used to fill the voids in this steel bridge deck.

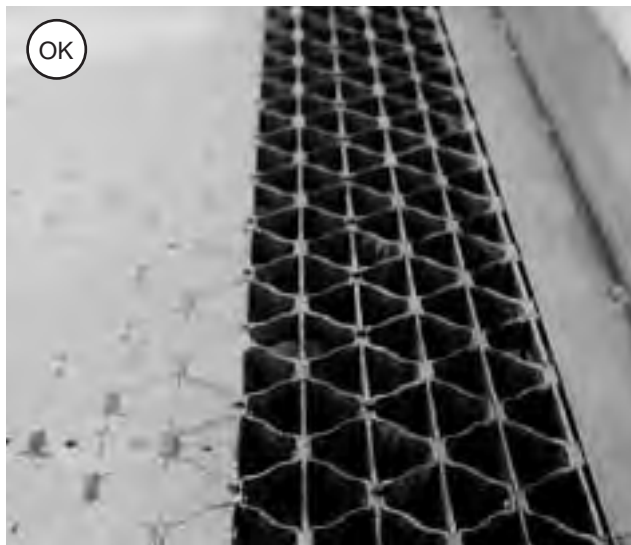

Surface conditions: On all bridge decks, special care should be taken to ensure that smooth bicycle-safe expansion joints are used. In cases where joints are uneven, skid-resistant steel plates may be attached to one side of the joint. Another option is to provide a rubberized joint filler or cover.

The bridge deck itself should not pose a hazard for bicyclists. Steel decking on draw bridges or swing bridges can cause steering difficulties for bicyclists. In general, such bridges should not be designated as bicycle facilities without determining the deck's effect on bicycle handling.

One option is to fill the voids in the steel deck with lightweight concrete (Fig. 2-58); to save money and weight, this treatment can be limited to the right sides near the edge of the roadway. If this approach is used, it is advisable to providing warning signs that direct bicyclists toward the treated surface.

The accumulation of roadside debris may cause problems for bicyclists, forcing them to ride farther out from the right edge than many would prefer (fig. 2-59). Regular maintenance, particularly in the right half of the outside lane and on any paved shoulders is important.

Figure 2-59: On this bridge, debris collects in the narrow striped shoulder; as a result of the surface conditions and the shoulder's width, motorists must change lanes to pass safely.



Bridge approaches: Bicycle provisions, whether bicycle lanes, paved shoulders, or wide outside lanes, should be provided for the approaches to bridges and, preferably, should continue 1000 ft (300 m) on either side of major bridges to ensure a safe transition. If on- or off-ramps or intersections are present, shoulders or wide outside lanes should continue at least as far as the ramps or intersections.

On lower-speed bridges and ramps, a bicycle lane crossing is similar to that used for turn lanes and a striping pattern should be used (see Sec. 3-7). If a wide outside lane is used, the extra width should be added to the right-most through lane (fig. 2-60).



Figure 2-60: At the end of a bridge with wide outside lanes, the extra width should continue in the through lane rather than the right turn lane.

On high-speed bridges and ramps, shoulder striping should not cross over the ramp, but should follow the ramp; another shoulder stripe should pick up on the far side of the ramp. On high-speed bridges and ramps, especially those with ramp AADTs over 800, it may be desirable for the bicycle lane to leave via the off-ramp and, if necessary, re-enter via the next available on-ramp.

2.9.2 Interchanges

Freeways present formidable barriers to bicycle circulation. Non-interchange crossings of freeways almost always provide a better level of service and safety to bicyclists and pedestrians (fig. 2-61). Unfortunately, because of the expense involved in bridging across freeways, few non-interchange crossings are constructed in suburban and urban areas.

Figure 2-61: The non-interchange crossing provides a lower-volume and easier freeway crossing for bicyclists than the interchange.



When planning or reconstructing freeways, providing more non-interchange crossings can improve conditions for bicyclists by eliminating ramps where conflicts often occur. Additional non-interchange crossings will also let local auto traffic avoid interchanges, making it easier for bicyclists (and motorists) using the interchanges. Although there will be more stress for bicyclists traveling through interchanges, bicycle accommodations should still be provided.

Figure 2-62: Urban-style interchange with right-angle intersections and, controlled movements.

There are ways to improve the level of service for bicyclists through interchanges by:

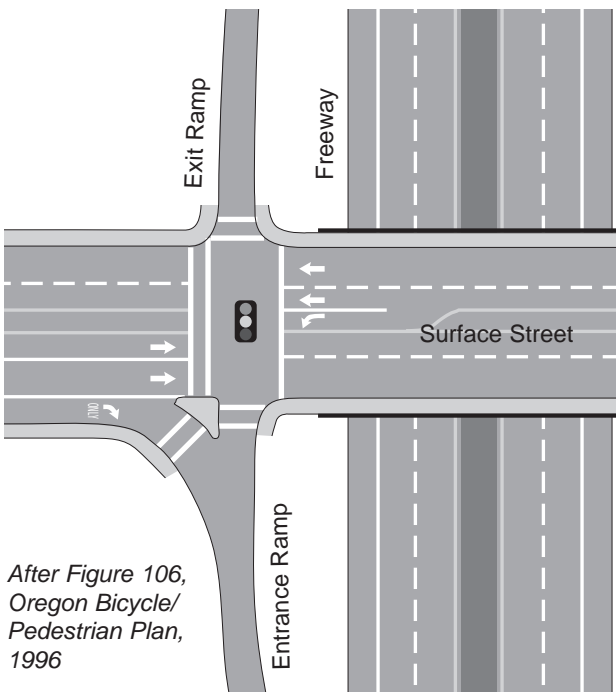

After Figure 106, Oregon Bicycle/Pedestrian Plan, 1996

- Avoiding designs that encourage free-flow motor vehicle movement (fig. 2-62 instead of 2-63).
- Freeway ramps should connect to local streets at or near a right angle with stop control or signals at the intersection.
- Where large trucks must be accommodated, using compound curves for the intersection of the ramp and local street to reduce the speed of intersecting traffic.
- Provide good visibility of bicyclists at ramp intersection with local roads

AASHTO provides guidance on the issue of ramp design. In its *Policy on Geometric Design of Highway and Streets* (2001), it states that interchanges should be studied for the most fitting arrangement of structures and ramps and accommodation of bicycle and pedestrians.

It goes on to say that where a ramp joins a major crossroad or street, forming an intersection at grade, the governing design speed for this portion of the ramp near the intersection should be predicated on near-minimum turning conditions as given in the chapter on intersections and not based on tables for establishing design speeds for ramps.



Figure 2-63: An interchange appropriate for a rural location but not a suburban or developing area.

In rural areas (fig. 2-63), not as much consideration needs to be made of interchange design since traffic volumes and bicycle use is typically much lower than in urban areas. Furthermore, bicyclists found in these areas are usually more experienced. Nevertheless, shoulder widths leading up to the interchange should continue through the interchange consistent with the bridge widths found in Figures 1 through 4 of FDM 11-15-1.

Also see AASHTO's *Guide to Bicycle Facilities, 4th edition*, and an ITE Proposed Recommended Practice: *Recommended Design Guidelines to Accommodate Pedestrians and Bicycles at Interchanges* for more information on interchange recommendations.

Figure 2-64: A residential street traffic circle slows traffic at intersections and reduces the frequency of intersection crashes.



2.10 Traffic Calming

The term “traffic calming” typically refers to environmental changes that (1) divert through motor vehicle traffic or (2) slow motor vehicle traffic. Traffic calming has a long history in places like Europe and Australia. Yet, over the last 20 years, the traffic calming field has also grown enormously in the United States.

These techniques have been tried in many communities (fig. 2-64) and the experience has been collected in numerous manuals, courses, and articles. The purpose of this section is not to provide detailed design guidance; rather it is to introduce the topic and discuss how typical calming measures can be designed to enhance neighborhood bicycling. If some traffic calming measures are done inappropriately, they may create problems and hazards for bicyclists. Similarly, without close cooperation with maintenance departments and emergency services to assure safe access, calming designs may cause more problems than they solve.

Traffic calming measures have been used most commonly on residential streets, often at the request of residents concerned with safety and quality of life. In some communities, traffic calming techniques have also been used on collector or arterial streets, often to slow traffic in such places as neighborhood business districts or downtowns.

Successful traffic calming measures are seldom applied at one single location or on one street. The best approach involves developing a community-wide program and process for implementing networks of improvements. The idea is to look at a neighborhood as a whole and develop a neighborhood-wide traffic control plan. In this way, neighborhood traffic problems will not simply be shifted from one street to the next.



Figure 2-65: A street closure keeps major street traffic from diverting onto this residential street. The short path (foreground, left) connects the neighborhood with a signalized crossing and the school beyond.

2.10.1 Traffic diversion approaches

Traffic calming measures of this type typically discourage through motor vehicle traffic with street closures or diverters (fig. 2-65 and 2-66). Such installations are often used in neighborhoods impacted by cut-through traffic avoiding busy arterial streets. In addition, the physical improvements are supplemented by proper regulatory and warning signage.



Figure 2-66: This mid-block street closure is part of a “bicycle boulevard,” a through route for bikes that avoids an adjacent busy arterial street.

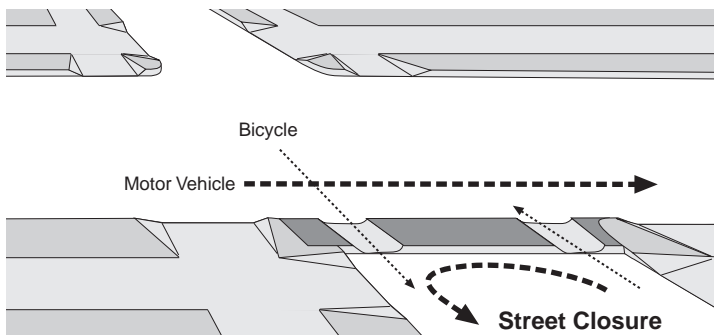

Fig. 2-67 (above).

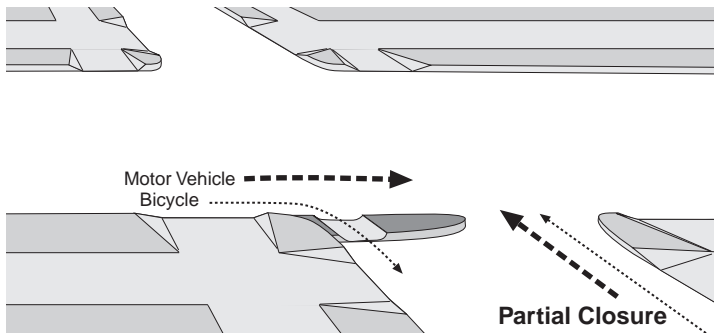

Fig. 2-68 (above).

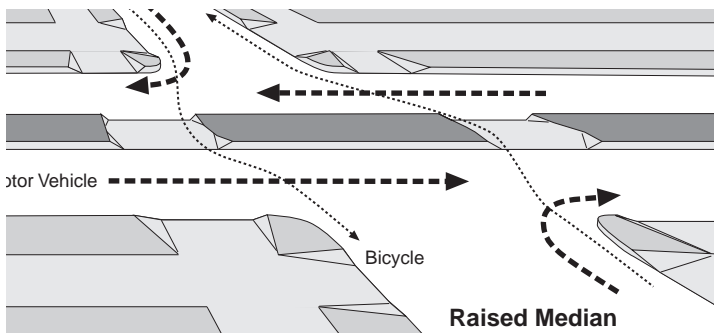

Fig. 2-69 (above).

Street closures block motor vehicle traffic entirely. While not as common as less severe treatments, they are occasionally used where cut-through traffic creates significant problems. As shown in Figure 2-66, they are sometimes installed at mid-block. If street closures are used, channels to allow bicycles through should be included (fig. 2-67).

Partial street closures are generally placed at intersections and prohibit one direction of motor vehicle. Bicyclists are allowed to ride past in either direction or may be provided with a channel as shown in Figure 2-68. The barrier may be supplemented with “Do Not Enter” regulatory signs and “Except Bikes” subplates.

Raised medians are often used on major streets to eliminate left turns into local streets and cross traffic from those streets (fig. 2-69, 2-70). If curb ramps or cuts are provided at the crosswalks, bicyclists and wheelchair users can get through. This design can also provide median refuges to help pedestrians and bicyclists cross busy multi-lane streets.

Figure 2-70: A raised median stops motor vehicle cross traffic and left turns. Curb ramps and cuts provide bicycle and pedestrian access.



Diverters are diagonal barriers placed at intersections to force all motorists to turn right or left (fig. 2-71). Unlike street closures, motorists do not have to turn around, however. Channels for bicyclists must be carefully designed to the geometrics of the intersection. In addition, each channel should be designed to safely work for both crossing directions.

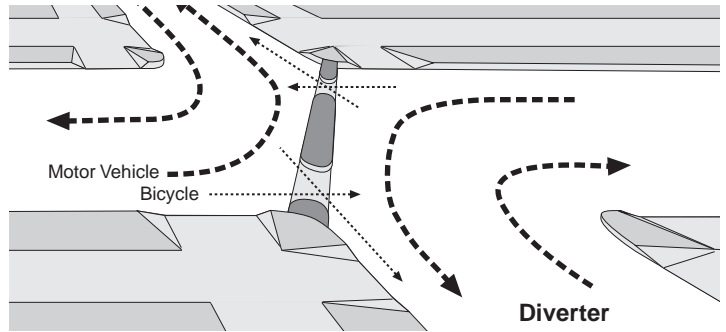

Fig. 2-71 (above).

Partial diverters only block particular movements. They typically force motorists to turn right rather than going straight or turning left (fig. 2-72). Depending on the geometrics, designers may provide a channel for bicyclists or they may widen the crosswalk to accommodate bike traffic with a slight diversion to the right.

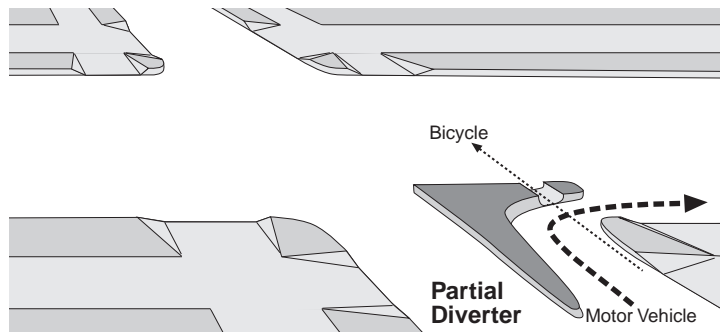

Fig. 2-72 (above).

2.10.2 Measures for slowing traffic

Other traffic calming measures allow motor vehicle traffic to proceed straight but are designed to slow traffic. While these are unlikely to reduce traffic volume on a residential street, they tend to reduce traffic speeds.

Residential street traffic circles are relatively small raised islands (fig. 2-73) located in the middle of an intersection. These force motorists to slow and divert to the right to pass around the circle. The size and shape is determined by specifics of the intersection. Since bicycles are relatively narrow, they can usually pass straight through.

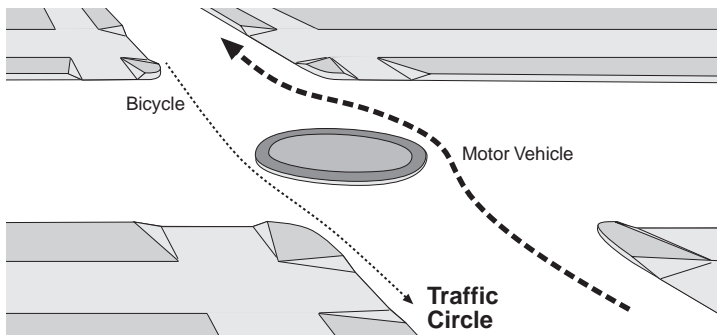

Fig. 2-73 (above).

Speed humps or speed tables are sections of raised roadway surface, typically 8 to 12 ft long (2.4 m to 3.6 m), that force motorists to slow down (fig. 2-74). These should not be confused with speed bumps, which are typically less than 3 ft. (1m) long and are found in parking lots or mobile home parks. [Speed bumps can catch a bicyclist's pedal or severely jar a front wheel and cause a crash.] Design speeds should be no less than 15mph.

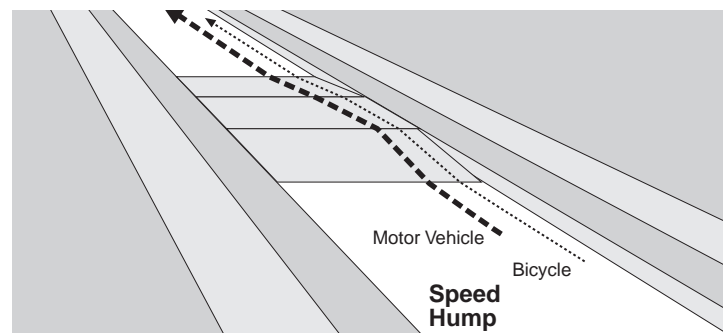

Fig. 2-74 (above).



Figure 2-75: A chicane forces traffic to divert left and then right.

Chicanes are staggered obstacles (e.g., expanded sidewalk areas, planters, street furniture, or parking bays) designed to shift the traffic stream side-to-side (fig. 2-75). The extent to which motorists slow depends on the design speed of the device, how close the obstacles are to each other, and how far to the left motorists must shift.

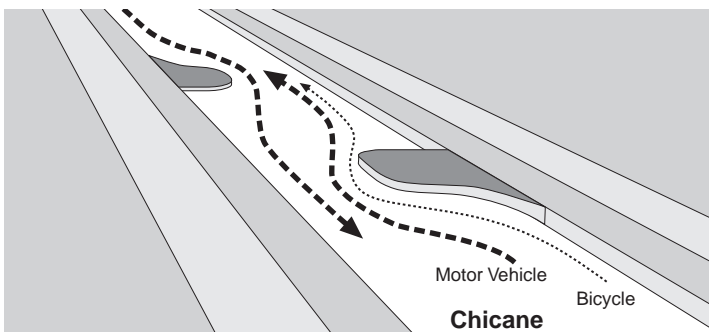

Fig. 2-76 (above).

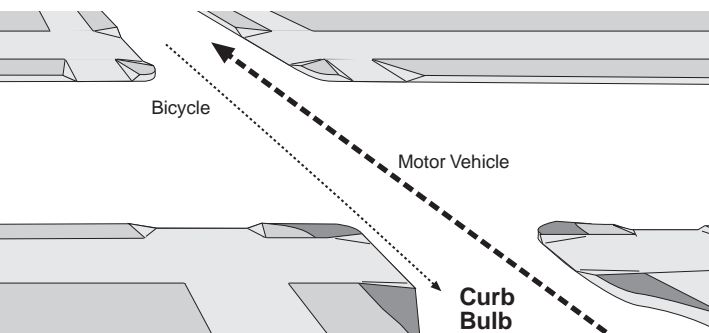

Fig. 2-77 (above).

Since bicyclists must divert the same as motorists through chicanes (fig. 2-76), the most successful designs use design speeds compatible with typical bicycle speed. They also work best on level terrain, where bicyclists can maintain a relatively uniform speed in both directions. In some cases, a channel can be provided outside the confines of the chicane.

Curb bulbs are sidewalk extensions that narrow the road and reduce crossing distances while increasing pedestrian visibility (fig. 2-77). They are often used in downtown shopping districts. The width of the extension should match the width of on-street parking and should not impinge upon bicycle lanes or the bicycle travel way (e.g., wide curb lanes).



Figure 2-78: A squeeze point with a speed hump narrows motor vehicles lanes but includes bicycle bypasses to the outside. This example also includes a speed hump. As with any traffic calming measure, they must be designed to work with maintenance and emergency vehicles.

Chokers or squeeze points narrow the street over a short distance to a single lane (fig. 2-78, 2-79). As a result, motorists must slow down and, occasionally, negotiate with on-coming traffic. Bicyclists are often provided channels to the outside so that they may avoid the squeeze point.

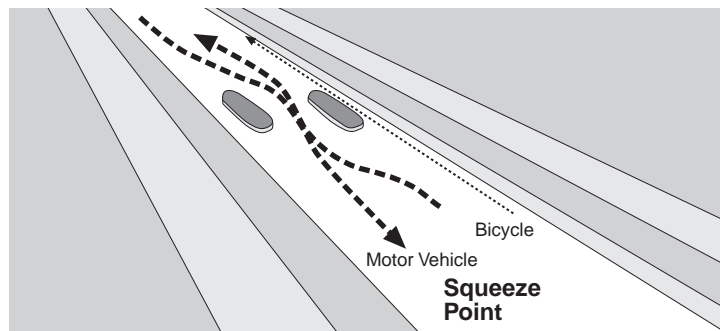

Fig. 2-79 (above).

Woonerf is a Dutch term meaning "living yard." It denotes a street design strategy in which motorized and non-motorized traffic are integrated on one level (fig. 2-80). Design features like perpendicular parking, play structures, plantings, and trees are purposefully placed to reduce traffic speeds and alert motorists to the fact they do not have priority over other traffic. These areas are primarily intended to serve the needs of residents of all ages. Bicyclists traveling through the woonerf do so at very slow speeds.

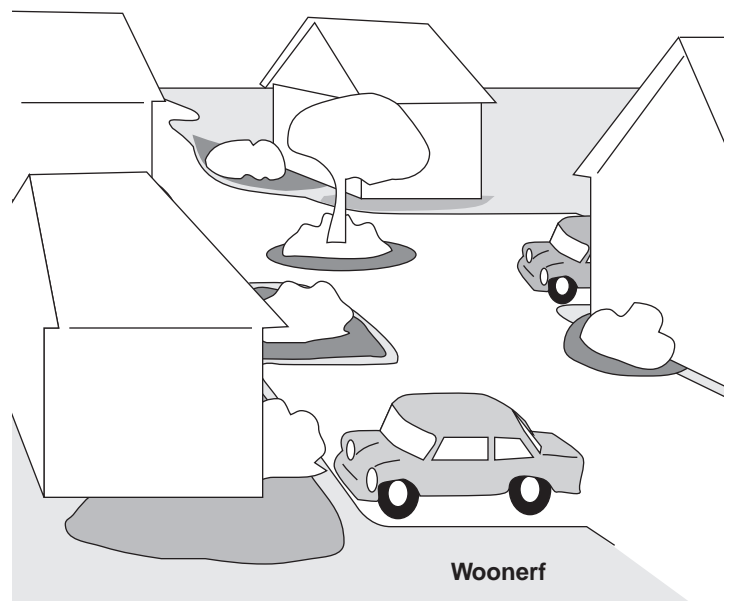

Fig. 2-80 (above).

These are only a few of the traffic calming measures used today. Whichever approach a designer chooses, the facility should consider the needs of bicyclists.

Figure 2-81: In rural areas, a particular bike route may have low traffic volumes, provide a direct route, or help bicyclists safely overcome a barrier.



2.11 Bicycle Route Designation

There are dozens of communities and counties in Wisconsin that have signed shared roadways as bicycle routes. These signed routes indicate a preference for bicyclists for one or more of the following reasons:

- *The route provides continuity to other bicycle facilities such as bike lanes and shared paths;*
- *The road is a common route for bicyclists because of its directness or land uses it serves;*
- *There is a need to assist bicyclists between two points with wayfinding devices because of the complexity of a particular route;*
- *In rural areas, the route is preferred for bicycling due to low volumes of motor vehicle traffic, directness, or its ability to help bicyclists safely overcome an upcoming barrier;*
- *The route runs parallel to a major roadway which has not yet been treated with wide curb lanes, bike lanes, or paved shoulders.*

Bike route signs may also be used on streets with bike lanes, as well as on shared use paths. This is especially important for wayfinding purposes if a single bikeway transitions from one type to another throughout a community. For example, if a particular segment of a community's bikeway consists of a shared use path, then continues to a set of bike lanes, then finishes as a shared roadway, it may be advantageous to use bike route signs to tie in all 3 bikeway types together and aid bicyclists in finding

their way. Bike route signs should always be accompanied with supplemental plaques that indicate the route's end point and/or its name (fig. 2-82). Showing mileage to a particular destination is also recommended.

There are examples in Wisconsin where bike route signage has been inappropriately used and does not support a real purpose. The following criteria should be considered prior to signing a route:

- *The route provides through and direct travel from one destination to another;*
- *The route connects discontinuous segments of shared use paths, bike lanes, and/or bike routes;*
- *An effort has been made, if necessary, to adjust traffic control devices to give greater priority to bicyclists on the route, as opposed to other parallel streets. This could include placement of bicycle-sensitive loop detectors where bicyclists stop at signals.*

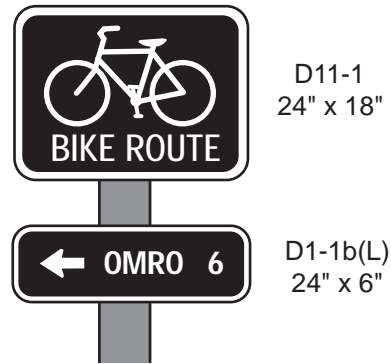

Figure 2-82: Standard D11-1 Bike Route and D1-1b signs.

Fig. 3-1: A typical striped bicycle lane on a section of roadway without parking.



3 Bicycle Lanes

A bicycle lane is a portion of the roadway designated for exclusive or preferential use by bicyclists. Bicycle lanes are always one-way facilities and are identified with pavement markings and signing. On two-way streets, a one-way bicycle lane should be provided on each side. Bicycle lanes are the preferred bicycle facility on higher volume urban and suburban roadways (i.e., collector and arterial streets) but are seldom justified on residential streets.

Among the benefits of bicycle lanes are:

- *Defining a space for bicyclists to ride;*
- *Helping less experienced bicyclists feel more confident and willing to ride on busier streets;*
- *Reducing motorist lane changing when passing bicyclists;*
- *Guiding bicyclists through intersections;*
- *Increasing bikeway visibility in the transportation system.*

Secondary benefits include:

- *Reducing the number of bicyclists using the sidewalk or gutter pan;*
- *Increasing the space between pedestrians and motorists (on streets without parking);*
- *Improving sight distances;*
- *Increasing effective turn radii at driveways and intersections;*
- *Providing temporary space for disabled motor vehicles or snow;*
- *Possibly reducing motor vehicle speeds.*

Note: Photos are categorized by their content:

YES Positive example

OK Special case example

NO Not recommended.



Fig. 3-2: Bicycle lanes should be one-way facilities, carrying traffic in the same direction as the adjacent motor vehicle travel lanes.

3.1 One-way vs. two-way bicycle lanes**

On two-way streets, bicycle lanes should always carry traffic in the same direction as the adjacent motor vehicle flow. Two-way bicycle lanes on one side of the roadway (Fig. 3-3) are unacceptable for the following reasons:



Fig. 3-3: Two-way bike lanes make it harder for bicyclists and motorists to see each other and increase conflicts at intersections and driveways.

- *Two-way bicycle lanes require one direction of bicycle traffic to ride against traffic, contrary to rules of the road.*
- *Wrong-way bicycling is a major cause of bicycle-motor vehicle crashes and should be discouraged at every opportunity;*
- *If the bicycle lanes end, bicyclists going against traffic may continue to travel on the wrong side of the street;*
- *Bicyclists may also travel on the wrong side of the street in order to reach the bicycle lanes;*
- *On the other hand, bicyclists riding on the correct side of the road may perform unusual crossing maneuvers to use the two-way bicycle lanes;*
- *Motorists entering or leaving the roadway may not look for the “wrong-way” bicycle traffic.*

**For information on two-way paths parallel to (but off of) the roadway, see Section 4.3.1.

Fig. 3-4: The proper location for a bicycle lane is to the left of the parking lane. In this location, bicyclists and motorists can clearly see each other.



3.2 Bicycle lane location

Bicycle lanes and parking: Where parking is prohibited, bicycle lanes should be placed next to the curb or edge of the roadway. There are exceptions, like where a bike lane is located to the left of a bus-only lane. Where parking lanes are provided, bicycle lanes should be placed between the parking lanes and the motor vehicle travel lanes.

Bicycle lanes between the curb and the parking lane should not be considered. Such bicycle lanes provide poor visibility for bicyclists and turning motorists at intersections and driveways. They trap bicyclists and provide no escape route in case of danger. For example, when a passenger in a parked car opens the door, the bicyclist has no place to go. And they make it impossible for bicyclists to make normal left turns.

Fig. 3-5: A bicycle lane to the right of parked cars creates sight obstructions, keeping bicyclists and turning or crossing motorists from seeing each other. This is particularly dangerous at intersections and driveways (see arrow). In addition, crossing pedestrians may not notice – or be noticed by – bicyclists.





Fig. 3-6: In special situations, bicycle lanes on the left (like the one shown) can work. But in most situations, bicycle lanes on one-way streets should be on the right, rather than the left.

Bicycle lanes on one-way streets: In general, bicycle lanes should be on the right side on one-way streets. This is where motorists expect to see bicyclists and is consistent with normal bicyclist behavior. For example, most bicyclists learn to look over their left shoulder for traffic, rather than their right. And right turns are more easily accomplished when one is close to the right side of the roadway.

Fig. 3-7: Part-time bicycle lanes are not recommended except in very special situations. And they require vigilant enforcement.

In certain circumstances, however, a bicycle lane on the left may decrease the number of conflicts (e.g., those caused by heavy bus traffic). Furthermore, there are far fewer people exiting cars from the passenger doors of parked cars. Such situations should be evaluated on a case-by-case basis. Certainly one item that should be considered is the frequency of left turns by motorists compared to right turns.

Part-time bicycle lanes: Part-time bicycle lanes are those where parking is allowed during part of the day; at other times, parking is prohibited and the lanes are used by bicyclists. Such bike lanes are not encouraged for general application, and should only be used in special circumstances.

For example, they might be appropriate if the vast majority of bicycle travel occurred during the hours of the parking prohibition. However, part-time bike lanes should only be considered if there is a firm commitment to enforce the parking prohibition. Bike lane striping should be accompanied by regulatory signs identifying the hours the bike lanes are to be in effect.



Peak hour wide lane: an alternative to part-time bicycle lanes

Providing a peak hour parking prohibition in wide outside lanes, rather than designating part-time bicycle lanes, may be preferable in many cases. During the peak hour, bicyclists and motorists share the extra width in the default wide lane. During off-peak hours, a default bike lane exists to the left of the parking.

Contraflow bicycle lanes: Contra-flow bicycle lanes accommodate bike traffic moving in the opposite direction from the rest of traffic. They are seldom used, and are not necessarily appropriate on a two-way street. However, on some one-way streets they may be suitable where:

- *They provide a substantial reduction in out-of-direction travel;*
- *Currently, there is significant wrong-way riding as a result of the added trip lengths;*
- *They provide direct access to high-use destinations;*
- *There are few intersecting streets, alleys, or driveways on the side of the contra-flow lane;*
- *Bicyclists can safely and conveniently enter and leave the contra-flow lane.*

Contra-flow bicycle lanes are sometimes found on arterial roadways (fig. 3-8). In addition, a contra-flow lane may also be appropriate on local access or residential streets that have been made one-way to calm traffic or otherwise restrict motor vehicle access.

Fig. 3-8: A contra-flow bicycle lane on a one-way street protected by a barrier because of high volumes of opposite-flow motor vehicle traffic. On the far side of the street, there is another bike lane for bicyclists going the same direction as traffic.





Fig. 3-9: Providing side street signage is an important element in creating a safe contra-flow bicycle lane. Note that the contraflow bike lane street is not signed as a one-way street. Motorists are simply prohibited from turning the wrong way.

For design purposes, it is useful to envision the candidate street as a two-way street with motor vehicles prohibited in one direction. This approach can help the designer determine where the contra-flow lane should be and how it should be marked. The following important design features should be incorporated:

- *Place the contra-flow bike lane on the far side of the street (to the motorists' left);*
- *Separate the contra-flow lane from the other travel lanes with a barrier (fig. 3-8) or a wide double yellow line.*
- *Post signs at intersecting streets and major driveways telling motorists to expect two-way bicycle traffic (fig. 3-9).*
- *Install appropriate traffic signs and signals for the contra-flow bicycle traffic.*
- *Use proper bike lane markings, but it is especially important to use directional arrows and occasional signage to reduce wrong-way riding.*
- *Determine in advance how the lane will be swept and cleared of snow.*

Because of the potential for serious safety problems associated with contra-flow bike lanes, they should only be used in well-chosen circumstances. They should also be carefully designed and evaluated following installation. See AASHTO's *Guide for the Development of Bicycle Facilities* for additional information.

Figure 3-10: With few exceptions (e.g., contraflow bicycle lanes), barrier-delineated bicycle lanes create more problems than they are intended to solve. For example, they hamper bicycle and motor vehicle turns and motorists exiting from a cross street or driveway can easily block a bicyclist's passage.



Barrier-delineated bicycle lanes: Barrier-delineated bicycle lanes were popular in the early days of bicycle planning and design (fig. 3-10). However, their popularity has largely waned over the past several decades. This is particularly the case in communities with active bicycle facilities programs. With few exceptions, raised barriers (e.g., pin-down curbs, raised traffic bars, and asphalt concrete dikes) should not be used to delineate bicycle lanes, for a number of reasons:

- *Raised barriers restrict the movement of bicyclists needing to enter or leave bike lanes (e.g., to make left turns);*
- *A motorist entering from a side street (fig. 3-10) can effectively block the lane;*
- *They make it impossible to merge the bicycle lane to the left of a right-turn lane;*
- *They are often used incorrectly by wrong-way bicyclists;*
- *They can be considered a hazard that can catch a bicyclist's pedal or front wheel, especially in narrow bike lanes;*
- *They use space that could be included in the bicycle lane;*
- *They collect debris and increase maintenance needs, as well as impede standard maintenance procedures, including snow removal.*

Roadway Median Bikeways and Sidewalk Bikeways

For information on bikeways in divided roadway medians, see Section 4.3.3. For information on sidewalk bikeways, see Section 4.3.1.

3.3 Bicycle lane surface quality

Bicycle lanes should be paved to the same standards as adjacent traffic lanes. The surface should be smooth and free of potholes and the pavement edge should be uniform, whether it meets a shoulder or a gutter pan. There should be no ridges or gaps that could catch a bicycle wheel.

Concrete and asphalt: In concrete construction, there should be no longitudinal joints in the bike lane or at the lane stripe, where they can be hidden by the paint. Joints should be saw-cut. This is especially important if a joint is placed between a bike lane and travel lane. The painted lane line should be placed on either side of the joint, ensuring the bike lane has a 5-ft (1.5m) width, measured from the curb face. With asphalt construction, the paved surface should continue smoothly to where it meets gutter pan level; pavement overlays should not be stopped at the bike lane stripe.

Grates and utilities: In addition, manholes, drainage grates, and utility covers should be located outside the bicycle lane because of the difficulty maintaining adequate tolerances. Grates should be contained fully within the standard 2-ft. (0.3m) gutter pan.

Maintenance: Cracks, potholes, and other imperfections should be repaired to an acceptable standard as part of routine maintenance procedures. Hazards for bicyclists are especially pronounced for cracks and faults that run in bicyclists' direction of travel. In addition, since bicycle lanes are not "swept" by the passing motor vehicles, they tend to collect debris. For this reason, sweepers should pay extra attention to the bike lane to keep it clear. Depending on the season, the particular roadway, and its surrounding environment, sweeping schedules may need to be adjusted to hit a particular bike lane more often than otherwise called for.

At the same time, proper construction can eliminate some of these problems from the start. For example, paving into unpaved driveways and cross streets can reduce the amount of debris brought up onto the bike lane by cross traffic.

In some communities, bicyclists ride through the winter. In other communities, they might like to if the bike lanes were clear. While experienced commuters may use special "studded" tires and often must "take" the travel lane, many bicyclists are reluctant to do so. It is understandable that during a storm, snow may be plowed into the bicycle lane. However, the bicycle lane should not be used for long-term snow storage. The snow should be removed quickly.



Fig. 3-11: Serious pavement cracks in a bicycle lane can cause a bicyclist's front wheel to turn, resulting in a crash.

Note: For more on maintenance issues, see Appendix A.

3.4 Bicycle lane width

Figure 3-12: A bicycle lane next to the curb on an asphalt roadway may be 4ft. wide. However, this should not include the gutter pan.

Curbed asphalt street, no parking: On a curbed asphalt street without parking, the standard clear width of a bicycle lane is 4 ft. (1.2 m), as measured from the inside of the stripe to the joint line with the gutter pan (fig. 3-12). Depending on whether a 1 ft. or 2 ft. (0.6 m) gutter pan is used, the total width from face of curb to the inside of the bicycle lane stripe would be either 5 or 6 ft. (1.5 - 1.8 m).

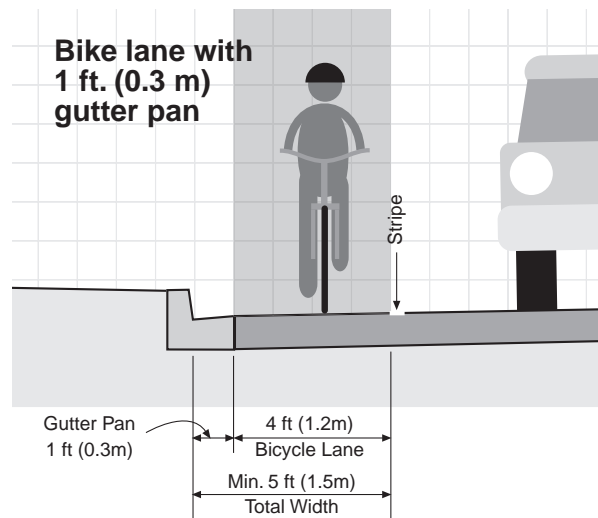

On an asphalt roadway, the width of the gutter pan is not included within the bicycle lane measurement because the gutter pan is not considered usable space. There are at least six reasons for this:

- *Riding in the gutter increases the likelihood that a bicyclist will hit a pedal on the curb;*
- *Joint lines between the roadway and gutter pan are often uneven and can cause a bicyclist to crash;*
- *Debris tends to collect in the gutter, having been swept there by passing motor vehicles;*
- *Drainage grates are most often located in the gutter pan;*
- *The gutter pan may have a greater cross slope than the rest of the roadway; this may cause problems for adult tricycles;*
- *A bicyclist riding close to the curb is less likely to be seen by motorists at cross streets and would have a more difficult time taking evasive action.*

Figure 3-13: A drain inset into a 1ft. curb head provides extra space in tight places.



Where space is tight but drainage requirements dictate an 18 in. (0.45 m) drain, a special 1 ft. (0.3 m) curbhead may be used with a 1 ft. (0.3 m) gutter pan (fig. 3-13).

At drain locations, the width of the curb head is reduced to 6 in. (0.15 m) to make room for the grate.

Curbed concrete street, no parking: On a concrete roadway with integral gutter and travel lane (Fig. 3-14), the distance from face of curb to the inside of the bicycle lane stripe should be a minimum of 5 ft. (1.5 m). While there is no joint line between the roadway and the gutter, bicyclists will still need a “shy distance” to the curb face, for safety reasons.

Wider bicycle lane situations: Wider bicycle lanes may be desirable in high use areas, on higher volume/higher speed facilities (≥ 40 mph) or where wider shoulders are warranted. Additional width is also desirable when the adjacent traffic lane is less than 11 ft. wide. In such conditions, motorists may drive closer to the bicycle lane and a wider bicycle lane can help keep the separation. Adequate marking or signing should be used so that the bike lanes are not mistaken for motor vehicle travel lanes or parking areas.

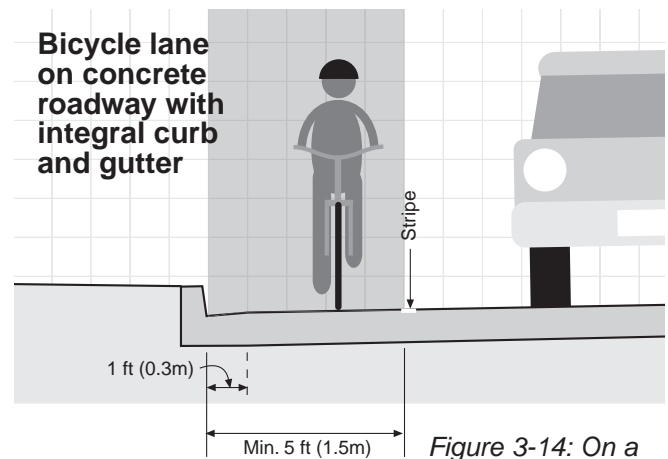

Figure 3-14: On a concrete roadway with integral gutter and travel lane, there is no gutter pan joint line. If a joint needs to be placed, it is best to locate it 1 ft. (0.3m) from the curb face.



Figure 3-15: Unlike bicycles, motor vehicles are not affected by the joint between the roadway and the gutter pan. As a result, the gutter pan is included when determining the width of the parking lane.

Curbed street with parking: As mentioned previously, on a curbed street with parking, the bicycle lane should be on the roadway side of the parking (Fig. 3-15). The standard width of a bicycle lane in such conditions is 5 ft. (1.5 m). This width allows a bicyclist to stay to the left in case someone in a parked car opens the door (Fig. 3-17). If parking volume is substantial or turnover high, 1 to 2 ft. (0.3 - 0.6 m) of additional width is desirable. An equally important dimension is the width of the parking lane — typically 8 to 10 ft. (2.4 m - 3 m).

Figure 3-16: Typical dimensions for a bicycle lane next to a parking lane.

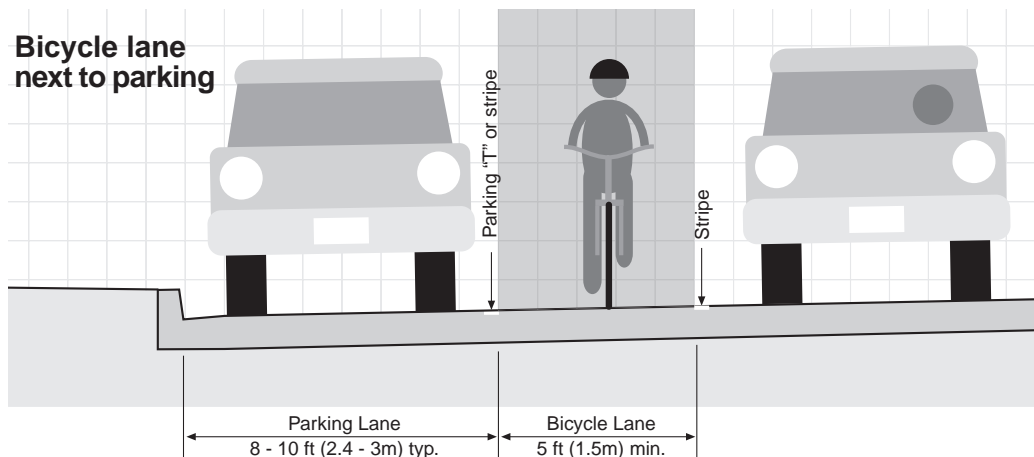

Fig. 3-17: An otherwise adequate bicycle lane next to a very narrow parking lane.

It may be tempting to narrow the parking lane to create more space for the bicycle lane. However, this approach can produce unintended results. Striping a narrow parking lane does not reduce the width of parked motor vehicles (Fig. 3-17). And they may take up part of the bike lane in the process. Narrowing the parking lane too much will put the bicyclist closer to the side of the parked car, leaving less clearance to get around an opening door. In those cases where the parking lane is narrowed to 7 ft. wide to make room for a wider bike lane, the recommended minimum width for the bike lane is 6 ft.

Overall, the total width of the bicycle and parking lanes should be a minimum of 13 ft. (3.9 m). In exceptional circumstances, a minimum combined width of 12 ft. (3.6 m) may be justified. This is acceptable in situations where the bike lane is adjacent to an 11 ft. or wider travel lane and there is low parking usage or where there is low to very low parking turnover. In this situation a 5 ft. wide bike lane can be used next to a 7 ft. wide parking lane.

Combining bicycle lanes and parking lanes without painting parking “T”s or striping between the two is found in some communities. However, the undesignated space may look like a motor vehicle lane. As a result, it may be preferable to identify the parking lane.

Combination “preferential lanes”: In some cases, a single preferential lane may be provided for several uses. For example, a right-hand lane may be a combination bicycle, bus, and right-turn lane (fig. 3-18). While not ideal, such a design can work if speeds and bus volumes are relatively low. Lanes should, ideally, be 16 ft. (4.8m) wide to accommodate all users. However, a 12-ft (3.6m) lane may be adequate, but buses will need to leave the restricted lane to pass bicyclists.

If bus volumes are high, a separate bicycle lane next to a combined bus/right-turn lane may be appropriate (fig. 3-19). The bicycle lane should be at least 5 ft. (1.2-1.5 m) wide and the combined bus/right-turn lane should be at least 12 ft. (3.6 m) wide.

Under higher volume conditions, putting the bicycle lane to the left of the bus/right-turn lane is preferable to placing the bicycle lane to the right. This is for some of the same reasons for placing the bicycle lane to the left of a right-turn-only lane (see “Right-turn lanes and bicycle lanes” on p. 3-21). However, it is also intended to address another problem: the need for buses to pull to the curb to discharge and take on passengers and the conflicts introduced with bicyclists passing on the right.



Figure 3-18: Signing and marking for a combination lane should clearly identify its purpose.



Figure 3-19: A well-used bicycle lane on a busy bus route puts the bicyclists to the left of the buses and right-turning motor vehicles.

Figure 3-20: Striping bicycle lanes on roadways without curbs can be an important improvement in fast growing suburban and exurban areas.



Roadway without curb or gutter: In general, undesignated striped shoulders should be used on rural-type roadways — those without curbs and gutters (see Section 2.1.4). However, such roadways may be found within communities or in developing areas; or they may serve as connections to important destinations (e.g., schools or parks) on the edge of town.

Figure 3-21 (below left): A Bicycle lane adjacent to a stable gravel shoulder on a roadway without curb or gutter.

Figure 3-22 (below right): On higher speed roadways, the marked bicycle lane should be at least 1.5m (5 ft) wide.

In these situations (fig. 3-20), designating (marking and signing) bicycle lanes can serve an important purpose. Bicycle lanes should be located between the motor vehicle travel lanes and the unpaved shoulder. On lower-speed roadways, bicycle lane widths of 4 ft. (1.2 m) may suffice (Fig. 3-21). But where motor vehicle speeds exceed 35mph, or where there are high motor vehicle volumes, a minimum width of 5 ft. (1.5 m) is recommended (Fig. 3-22). Even greater widths may be advisable on long downgrades.

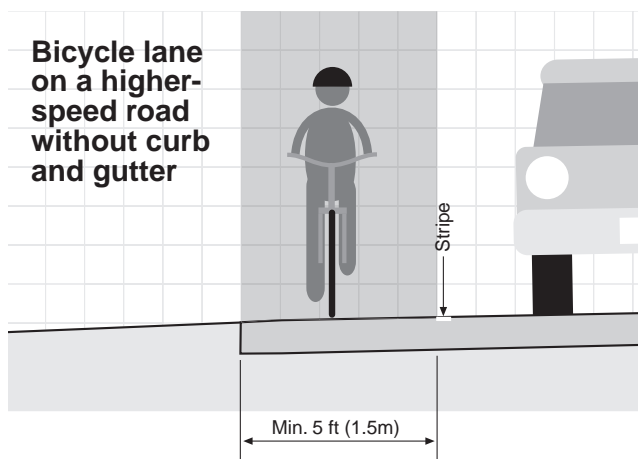
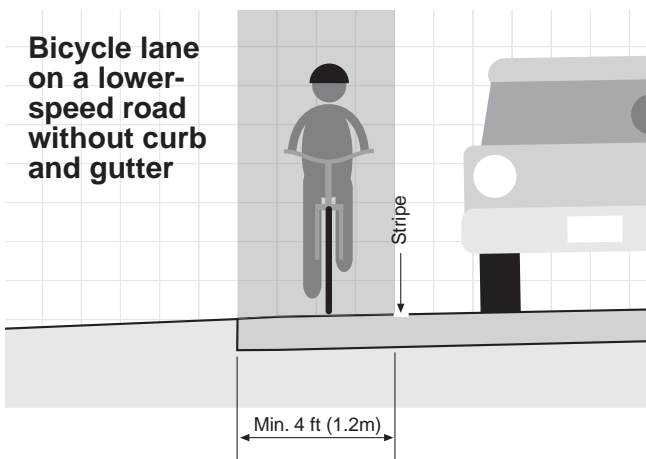

Where these widths cannot be achieved, bicyclists will still benefit from striped shoulders (see Section 2.6). However, such shoulder should simply be designated with an edge line and should not be marked or signed as bicycle lanes. Additional width is also desirable where substantial truck traffic is present.



Figure 3-23: The three primary elements that identify a bicycle lane: regulatory signs, lane striping, and pavement markings.

3.5 Bicycle lane designation

In general, bicycle lanes are designated with signs, lane striping, and pavement markings (fig. 3-23). These elements must comply with Part 9 of the Manual on Uniform Traffic Control Devices (MUTCD); some of the signs mentioned in the MUTCD are shown below.

Bicycle lane signing: The primary signs along a bicycle lane are:

- **R3-16:** used in advance of a marked bicycle lane to call attention to the lane and possible presence of bicyclists.
- **R3-16a:** used to notify bicyclists that the bicycle lane is ending.
- **R3-17:** for bicycle lanes with no parking allowed; install this at periodic intervals along the bicycle lane. The words “LEFT” or “CURB” may be substituted for RIGHT if appropriate.
- **R3-17a:** for bicycle lanes with parking, and is used to tell bicyclists they may encounter parked vehicles; install this at periodic intervals.

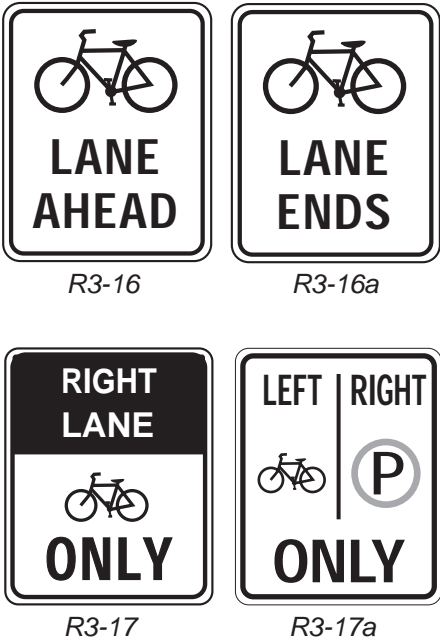

Figure 3-24: The R3-16 and R3-16a signs should be used in advance of the start and at the end of a bicycle lane, respectively.

Figure 3-25: The R3-17 and R3-17a signs should be used at periodic intervals along the bicycle lane.

Figure 3-26: The R7-9 or R7-9a should be used where parking is prohibited. The R4-4 should be used in advance of an exclusive right turn lane.



R7-9



R7-9a



R4-4

Other signs used along bicycle lanes include:

- **R7-9**, prohibiting parking in bicycle lanes, where no parking lane is provided.
- **R7-9a**, a graphic version of the R7-9.
- **R4-4**, installed where motorists entering a right-turn lane must weave across bicycle traffic in bicycle lanes; intended to inform the driver and the bicyclist of this weaving maneuver.

Bicycle lane striping: Bicycle lanes should be demarcated with 4- to 6-in. (100 to 150 mm) white lines using traffic paint or equivalent (e.g., epoxy, cold plastic, etc.). At most locations, lines should be solid, with dashed lines at certain intersections (see Sec. 3.6 and Fig. 3.36) or at bus stops (fig. 3-32). Some materials (e.g., some types of thermoplastic) have been found to be slippery. As a result, materials should be warranted by the manufacturer as “skid-resistant.”

Figure 3-27: Bicycle lane striping and marking next to a curb.



Bike lane stripes should be placed a constant distance from the outside motor vehicle lane. Bike lanes with parking permitted should not be directed toward the curb at intersections or short stretches where parking is prohibited. This would prevent bicyclists from following a straight course. Where one type of bike lane transitions to another, smooth tapers should be provided in accordance with the MUTCD.

Figure 3-28: The standard marking for a bicycle lane is the bicyclist symbol accompanied by an arrow.

Pavement markings: Pavement markings are used, in conjunction with striping and signing, to identify bicycle lanes. The standard marking is a combination of a bicycle symbol and a directional arrow (fig. 3-28). The pavement marking shall be white.

Designers may, if they choose, select one of the following as an alternative pavement marking (fig. 3-29):

- The words “Bike Lane” with a directional arrow;
- The words “Bike Only” with an arrow;
- The bicycle or bicyclist symbols followed by the word “Lane” and the arrow.

The “Bike Lane Ends” marking should be used where a bicycle lane terminates, not simply where the striping stops for an intersection or other brief interruption.

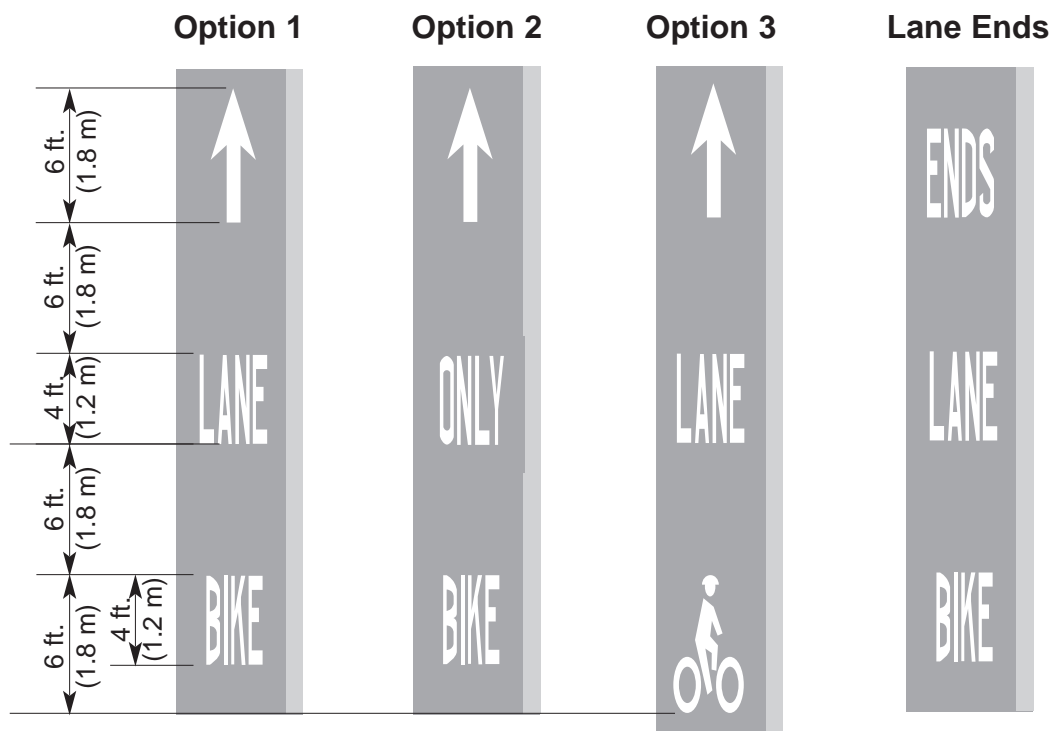
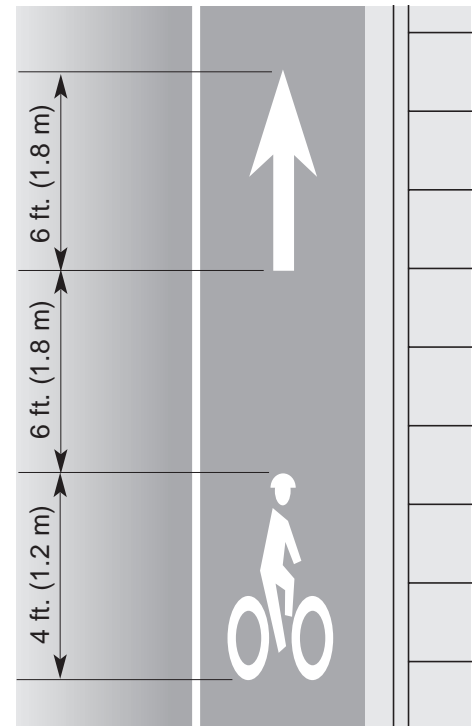

Figure 3-30: Three optional markings: “Bike Lane,” “Bike Only” and the bike symbol accompanied by the word “Lane.” “Bike Lane Ends” should be placed at the termination of a bike lane section.

Figure 3-31: Lane markings should be spaced about every 600 ft. (180m) for urban sections and every 1 mi. (1.6km) for rural sections.



Lane markings should be appropriately spaced (e.g., about every 600 ft. (180 m) for urban sections and 1 mi. (1.6 km) for rural sections) and placed after every major intersection. Lane markings should also be placed in the short sections of bike lanes used at intersections, most commonly to the left of the right-turn only lane (fig. 3-33).

Bicycle lane signs, striping, and marking: Putting the three elements together, it is possible to create a consistent and comprehensible street design including bicycle lanes.

The two primary signing, striping, and marking designs involve bicycle lanes with or without parking (fig. 3-32). With-parking designs offer two bike lane sign options (R3-17 and R3-17a) that go with an R7 series sign for parking limitations. The no-parking design has three options. The first combines the R3-17 Bike Lane sign and the R8-3a No Parking sign. The other two use either R7-9 or R7-9a combined bike lane/no parking sign.

Standard bicycle lane markings

Figure 3-32: Bicycle lane elements on roadway sections with parking and without. Examples of two types of parking pavement markings are shown. Note dotted line for bus stop on section without parking.

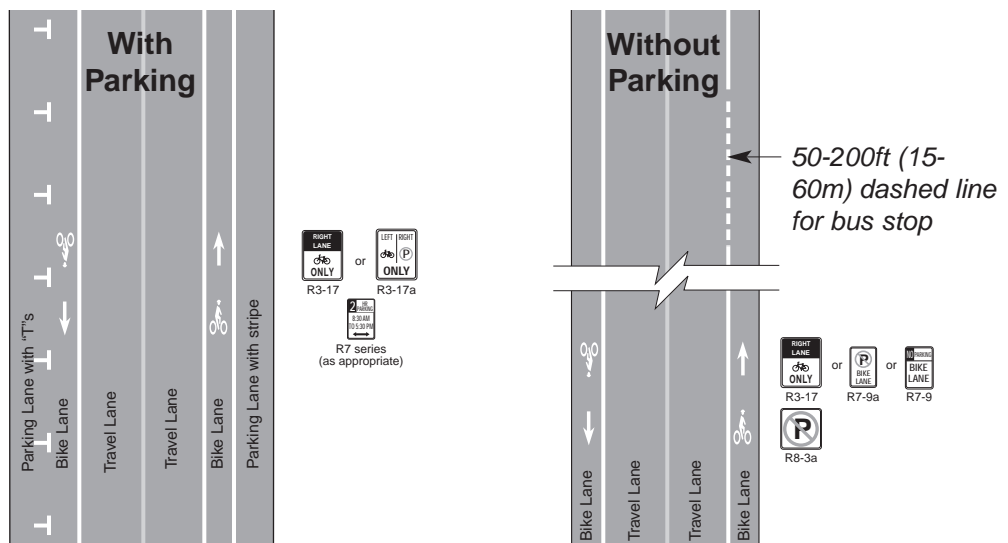



Figure 3-33: Well-designed intersection bicycle lanes can help bicyclists deal with the complexities of traffic movements.

3.6 Bicycle lane intersection design

Bicycle lane treatments at intersections vary according to a number of factors. The primary ones involve the complexity of the intersection, the level of right turning traffic and the presence (or absence) of right turn lanes, either dedicated or optional. These factors should be evaluated based on an understanding of safe bicycling practice and proper turning procedures (see Sidebar below)

Bicycles and intersections

In Wisconsin, bicycles are vehicles and bicyclists have the same rights and duties as other drivers of vehicles. Understanding how lawful bicyclists deal with intersections can help designers provide facilities that foster, rather than hamper, bicyclists' mobility and safety.

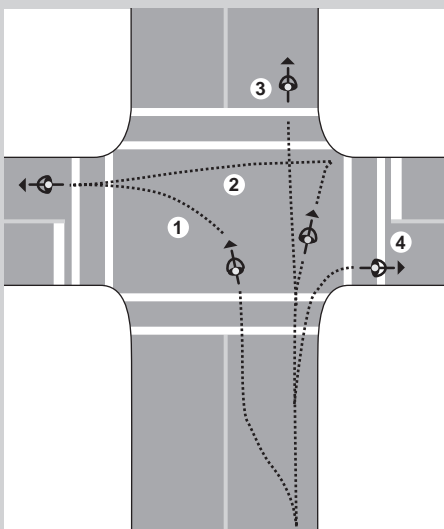

Going straight: Bicyclists should go straight from the lane intended for that purpose (3). They should not move right — or into a right-turn lane — nor should they ride too close to the curb, lest they be seen as making a right turn.

Turning left: Bicyclists should turn left in one of two ways: (1) merging to a left turn lane or a position near the center of the roadway, much like a motorist; or (2) making a two-stage turn, stopping at the far corner and proceeding across when safe.

Turning right: Bicyclists should turn right (4) by moving toward the right side of the roadway or into a right turn lane and continuing around the corner.

Figure 3-34: Bicycle lane stripes should start at the marked crosswalk or the extension of the adjacent property line.



Figure 3-35: Low-volume cross streets with little right turning traffic can be treated with basic striping, marking, and signage. The image at right shows a solid bike lane strip without parking and with no right turns.

Bike lane text should be placed immediately after, but not closer than 65 ft. (20 m) from, a crossroad. Placed too close to an intersection, the markings may wear quickly due to crossing motor vehicle traffic. The same is true for similar locations (e.g., major commercial driveways). Markings may be placed at other locations as needed.

Simple intersections with few right turns: Most streets with bicycle lanes intersect numerous minor cross streets. The intersections may be controlled with stop signs on the side street and generally feature few conflicts and negligible levels of right turn traffic from the bicycle lane street.

At such intersections, the dashed line alternative is recommended. At intersections with either no right-turning traffic or extremely low levels of right-turning traffic, the bicycle lanes may be striped to the crosswalk and dropped through the intersection (fig. 3-35). If there is no painted crosswalk, the bike lane stripe should continue to the extension of the adjacent property line. Stripes should be picked up beyond the intersection (fig. 3-34).

Simple Intersections with few right turns

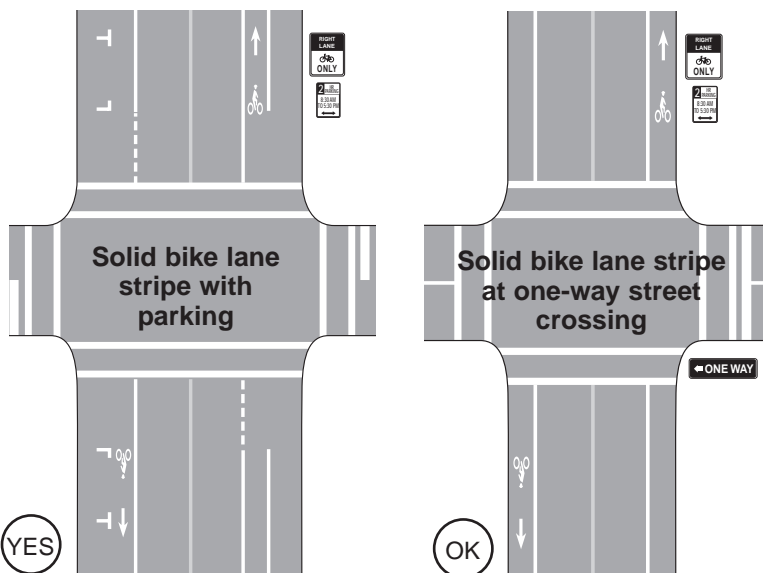

If there is a parking lane outside the bicycle lane, the bicycle lane stripe should still be continued to the crosswalk (or extension of adjacent property line). The parking lane markings, however, should be dropped the appropriate distance from the intersection to allow proper sight distances.

Figure 3-36: With moderate levels of right-turning traffic, the bicycle lane should be dashed.

Simple intersections with moderate right turn traffic: At other minor intersections, right turning traffic is moderate but does not warrant a dedicated turn lane. In these cases, the solid bicycle lane line should be dropped and replaced with a dashed line (fig. 3-36).

The dashed line should alternate 2ft. (0.6m) dashes with 6ft. (1.8m) spaces. It should begin between 50 and 200 feet (15m - 60m) from the crosswalk, depending on traffic speeds.

Simple Intersections with moderately-light to heavy right turn traffic

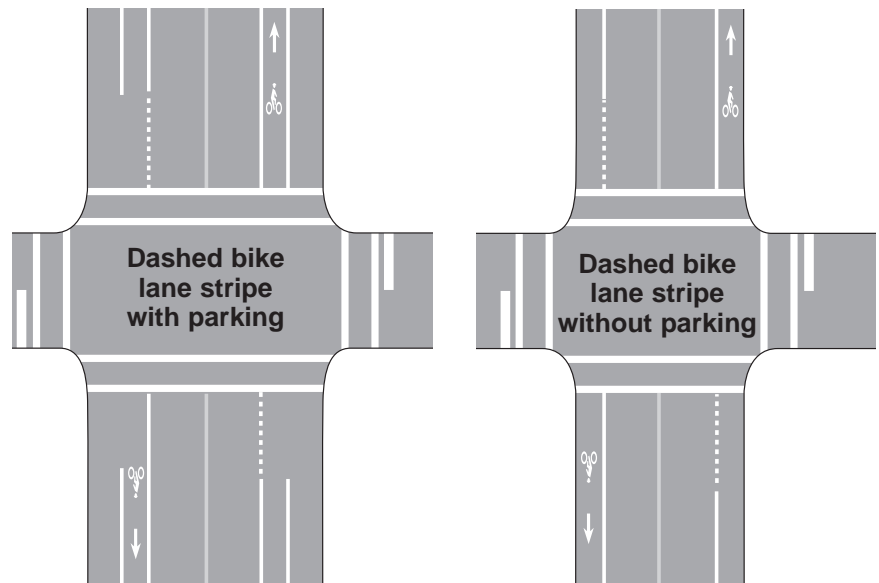

Right-turn lanes and bicycle lanes

Intersections with right-turn lanes have always posed a challenge for bike lane designers. In the early days, designers striped bike lanes to the right of right-turn lanes. Unfortunately, this approach created a conflict point for bicyclists going straight and motorists turning right.

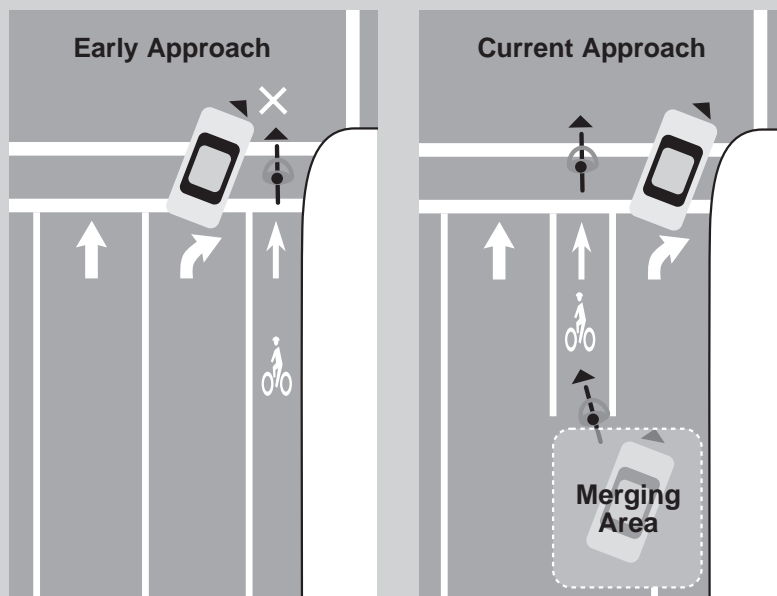

Moving the bicycle lane to the left of the right-turn lane, however, allowed designers to create a *merging area* ahead of the intersection. This gave bicyclists and motorists the opportunity to negotiate to the proper position before reaching the intersection.

The merging area could be long or short, depending on motor vehicle speeds and turning volumes. This concept has formed the basis of the current design approach to right-turn lanes.

Figure 3-37: This intersection features a bicycle lane to the left of a right-turn lane. Note how it lines up with the bicycle lane on the far side of the intersection.



Tip
 In some cases, it helps to think of the bicycle lane and the right through lane as a pair. When the through lane shifts one way or the other — to create a turn lane or a parking lane, for example — the bicycle lane shifts as well.

3.7 Intersections with right-turn lanes

Right-turn lanes often complicate bicycle lane systems (see sidebar on previous page). For this reason, designers should start a bike lane intersection project by first looking at the need for the right-turn lane. In some cases, it may not be warranted and may be eliminated. If right-turn lanes are warranted, there are several designs that can help get the bicycle lane through such an intersection. Several factors help determine the best approach.

Figure 3-38: A bicycle lane installation where a right-turn lane replaces on-street parking at the intersection.

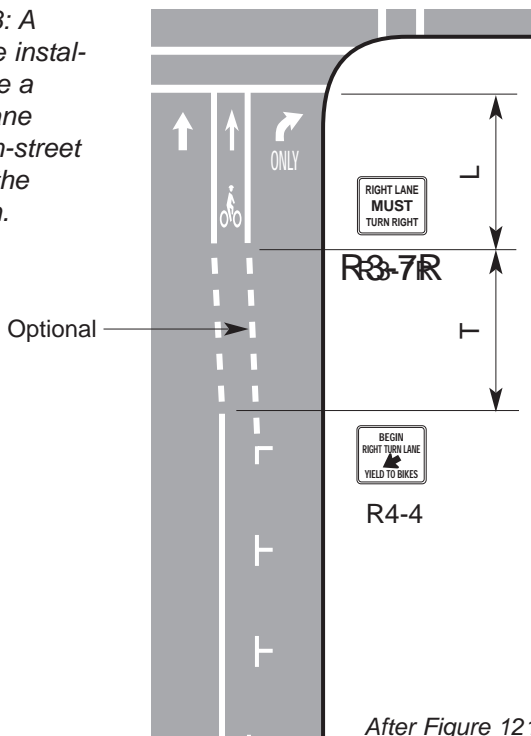

Right-turn lanes and on-street parking: If the bicycle lane street has on-street parking, dropping the parking lane can create most of the space required for the right turn lane. And, in many cases, the bicycle lane will only have to shift slightly to the left (fig. 3-38). Lane striping should be solid in the storage area and dashed in the taper. Lengths of each should be determined based on right-turn lane requirements (see below).

A second dashed line may be used to delineate the right side of the bicycle lane.

L = Storage length required for right turns
T = Taper length needed for motorists to merge (to be calculated based on standard right-turn configuration)

After Figure 121, Oregon Bicycle/Pedestrian Plan, 1996

Right-turn lanes on widened roadways with no on-street parking: In many cases, the street with bicycle lanes has no on-street parking, but the roadway widens to accept the right-turn lane. In these situations, the bicycle lane should continue across with a dashed line. The length of the right-turn storage area and the taper will determine the length of the dashed line. A second dashed line may be used to delineate the right side of the bicycle lane.

Right-turn lanes on roadways where right through lane is dropped: Roadways where the right through lane is dropped to create the right-turn lane are more difficult situations to deal with. In these cases, the bicycle lane must move to the left, the width of a travel lane. Dropping the right bicycle lane line in this merging zone is an acceptable alternative (fig. 3-40).

Another approach is to stop the curb bicycle lane's solid stripe at the merge zone, replacing it with a dashed line. The bicycle lane to the left of the right-turn lane should then begin with a dashed line (fig. 3-41).

Right turn lane next to optional right turn lane: Optional right-turn lanes create additional problems because the path of the occupying motor vehicle may be either straight or right. As a result, a bicycle lane should not be striped to the right of the optional right-turn lane. Nor should it be striped to the left. In these cases, re-evaluating the warrants for the optional lane

should be considered. Otherwise, the bicycle lane should be dropped until after the intersection. A W11-1 warning sign, accompanied by a W11-16 ("Share the Road") subplate may be used.



W11-1, W11-16

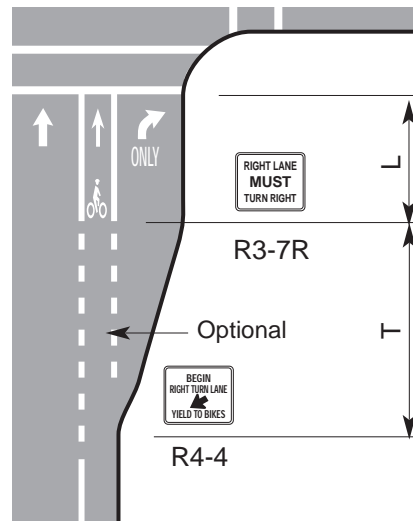

Figure 3-39: This roadway has been widened for a right turn lane. The bicycle lane should continue across the taper as shown with a dashed line.

L = Storage length required for right turns
 T = Taper length needed for motorists to merge

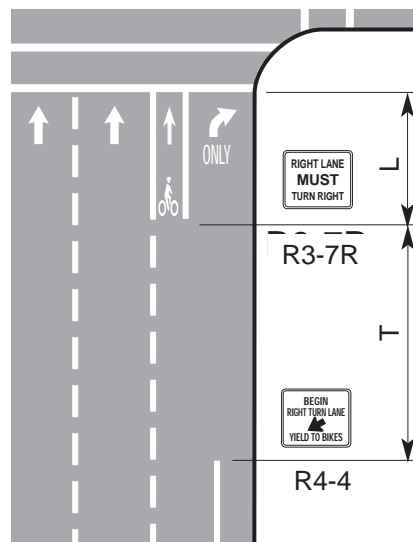

Figure 3-40: Where the right through lane becomes the right turn lane, dropping the lane stripes in the merge zone is an acceptable approach.

Figure 3-41 (below right): Another approach is to dash the approaching bicycle lane line part way through the merge zone and dot the right line of the intersection bike lane to match.

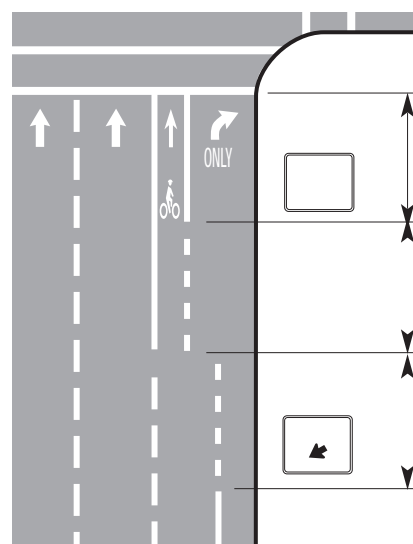

Figure 3-42 (below left): The "Share the road" sign combination.

L = Storage length required for right turns
 $D1, D2$ = Distance needed for bicyclists to merge left (to be field-determined for each case)

After Figure 122, Oregon Bicycle/Pedestrian Plan, 1996

Figure 3-42: A bicycle left-turn lane can help serve heavy bicycle traffic.



Figure 3-43: As shown in this illustration, dashed lines may be used to lead bicyclists to the destination bicycle lane.

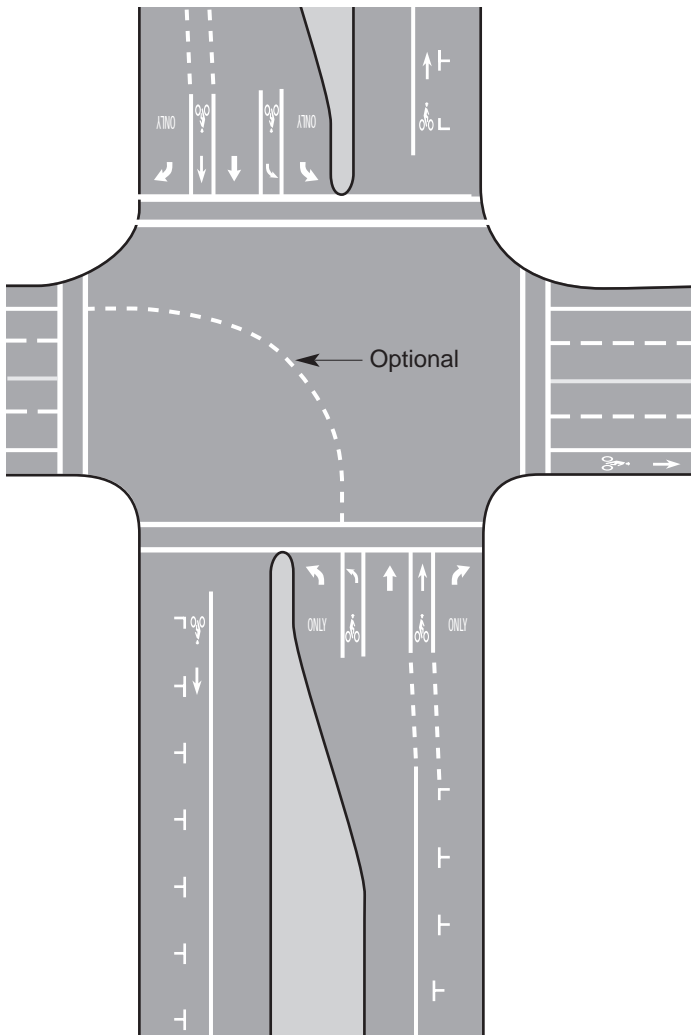

3.8 Left-turn bicycle lane

Bicyclists making left turns will sometimes use the two-stage turn (see “Bicycles and intersections” on p. 3-19), crossing the intersection and stopping at the far side before continuing. Or they may move into a vehicular left turn position (e.g., in the left turn lane) and turn from there. In most cases, there is no particular bicycle facility required to support either of these two options.

Where there are numerous left-turning bicyclists, however, one approach is to provide a separate bicycle left-turn lane, as shown in Figure 3-43.

There are several advantages to this design. For example, it can free up space in the motor vehicle left-turn lane. It can also provide space for more left turning bicyclists. Note the optional dashed line through the intersection. This provides guidance for the bicyclists making their left turn.



Figure 3-44: An urban-style interchange design is easier for bicyclists to negotiate than a rural-style design with its high-speed merges and broad sweeping curves.

3.9 Interchanges

Freeways in urban areas often present barriers to bicycling. Though interchanges function as freeway crossings, they can be obstacles if poorly designed. Bicyclists should be accommodated on the intersecting and parallel streets in urban areas. (Also see discussion in the *Shared Roadway* Chapter, Section 2.9.2)

In rural areas, traffic volumes are usually lower and recreational and touring bicyclists are usually experienced enough to make their way through an interchange. The most useful improvement is to provide adequate shoulder widths through interchanges. However, in urban and suburban areas, bicyclists of all skill levels use the intersecting cross-streets. Well-designed interchanges provide safe and convenient passage from one side to the other.

As mentioned in Section 2.9.2, interchanges in developed (and developing) areas should be designed to an urban model, with tighter curve radii and intersections (fig. 3-44) rather than long



Figure 3-45: Interchanges with high-speed turns and merges are suited only to an environment that will remain rural.

Figure 3-46:
Urban-style right-angle intersections at interchanges can be more easily designed with bicycle lanes than can rural interchanges.

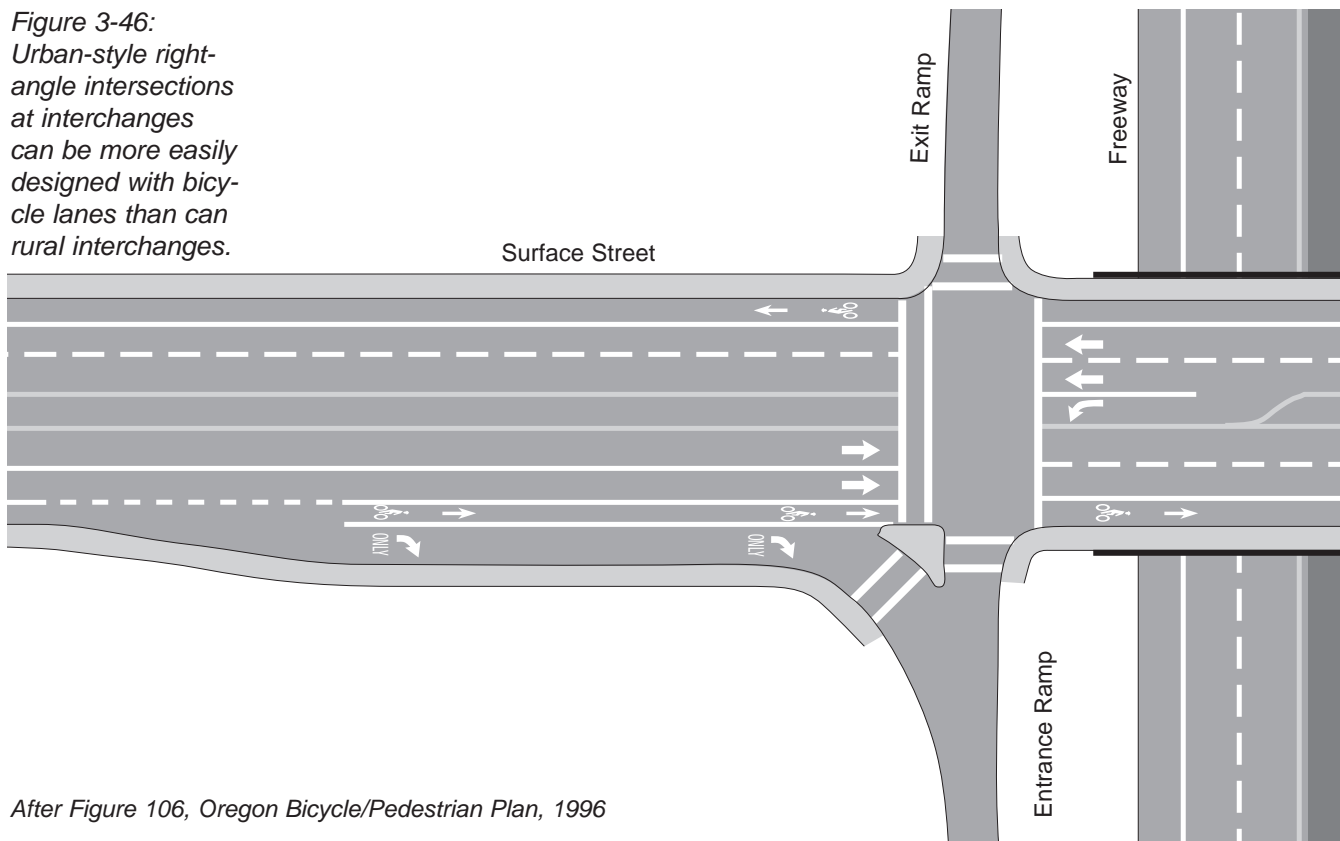

After Figure 106, Oregon Bicycle/Pedestrian Plan, 1996

ramps designed for high speeds (fig. 3.45). Figure 3-46 shows how an urban-style interchange can be designed with bicycle lanes.

Configurations with free-flowing right turns and dual left- or right-turns are difficult for bicyclists to negotiate safely. They are particularly vulnerable where a high-speed ramp merges with a roadway. If these configurations are unavoidable, mitigation measures should be sought. Special designs should be considered that allow bicyclists to cross ramps in locations with good visibility and where speeds are low. See the *AASHTO Guide to Bicycle Facilities* and an ITE Proposed Recommended Practice: *Recommended Design Guidelines to Accommodate Pedestrians and Bicycles at Interchanges* for options that may be used for interchange markings where higher speed ramps are unavoidable.

Another option to consider seriously is the provision of intermediate freeway crossings between interchanges. These completely eliminate the conflicts with on- and off-ramp traffic. Further, such crossings typically involve lower volume roadways (e.g., collectors) where many bicyclists will feel more comfortable.



Figure 4-1 (left and right): Shared-use paths often serve as necessary and important extensions to the roadway network.



4. Shared-use Paths

Shared-use paths are largely non-motorized facilities** most often built on exclusive rights-of-way with relatively few motor vehicle crossings. Properly used, shared-use paths are a complementary system of off-road transportation routes for bicyclists and others. They serve as a necessary extension of the roadway network. Shared-use paths should not substitute for on-road bicycle facilities, but, rather, supplement a system of on-road bike lanes, wide outside lanes, paved shoulders, and bike routes. *Since paths are always used by pedestrians, their design also needs to comply with ADA requirements.*

4.1 Shared-use path users, purposes, and locations

Shared-use paths support a wide variety of non-motorized travelers — bicyclists, in-line skaters, roller skaters, wheelchair users, walkers, runners, people with baby strollers or people walking dogs (fig. 4-2). Many state “rail trails” are open to snowmobile use during the winter. Shared-use paths are most commonly designed for two-way travel, and the guidance herein assumes two-way use unless otherwise stated. Shared-use paths can serve a variety of important purposes:

- a shortcut to a nearby destination or through a neighborhood;
- an alternative to a busy thoroughfare or a “motor vehicle-only” corridor;
- a way to get across a motorized barrier, especially a freeway;
- an enjoyable travel opportunity for individuals and families
- a place to exercise, recreate, or rehabilitate from injury.

**There are many state trails in Wisconsin that permit snowmobile use. Motorized wheelchairs are allowed on most paths.

Note: Photos are categorized by their content:

- YES** Positive example
- OK** Special case example
- NO** Not recommended.

To accomplish these ends, shared-use paths have been built:

- *along rivers, creeks, and lake fronts;*
- *on or next to railroad rights-of-way (abandoned or active), and utility easements;*
- *within college campuses or within and between parks; and*
- *between cul-de-sac streets in new developments.*

By analyzing barriers to non-motorized travel, popular corridors and destinations, and potential path opportunities, appropriate locations can be identified.

4.2 Designing paths and roads: differences and similarities

There are numerous similarities and differences between the design criteria for shared-use paths and highways. The designer should always be aware of these factors and how they influence the design of shared-use paths.

Similarities include the need for:

- *carefully designed vertical grades and curves;*
- *routine maintenance (e.g., joint filling);*
- *adequate curve radii;*
- *adequate sight distance at curves and intersections;*
- *warning, regulatory, and informational signs where required;*
- *basic pavement markings; and*
- *routine all-weather maintenance.*

Differences include such things as:

- *vehicle size and clearance requirements;*
- *wide variety of bicycle user ages and capabilities;*
- *design speeds used to determine geometrics;*
- *grades that bicycles and motor vehicles can typically negotiate; and*
- *pavement structure needed to support typical path vs. road traffic.*

The remainder of this section provides guidance on each factor that should be considered in designing safe and functional shared-use paths.

Figure 4-2: Shared-use paths must accommodate a wide variety of users — young, old, bicyclists, tricyclists, pedestrians, wheel chair users, inline skaters, and more.



4.3 Shared-use paths next to roadways

Separated shared-use paths (bicycle paths) are options primarily along river grades, lake fronts, or abandoned or shared rail corridors; they may also connect subdivisions and cul-de-sacs. Paths next to urban and suburban roadways pose operational problems and often increase the hazards to bicyclists. This section summarizes problems with paths adjacent to roadways. In some cases, paths along highways for short sections are permissible, given an appropriate level of separation between facilities.

4.3.1 Problems with paths next to roadways (sidepaths):

1. Cross-Street and Driveway Conflicts

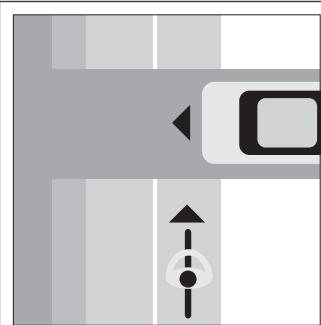

Motorists may *think* bicyclists have to stop at all cross-streets or driveways.

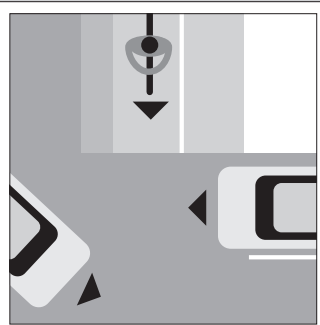

Motorists crossing the path may not even notice it — or the contraflow bicyclists.

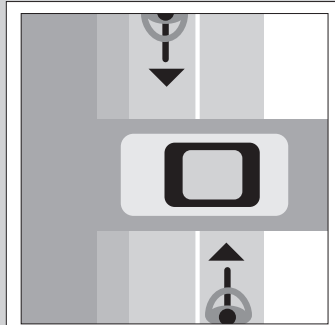

Stopped motor vehicles on side streets or driveways may block the path.

Most bicycle-motor vehicle crashes occur at intersections of roads or of roads and driveways; paths should not aggravate the problem.

2. Encouragement of Wrong-Way Bicycling

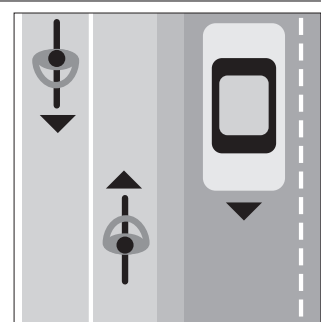

One direction of bicyclists must ride against traffic.

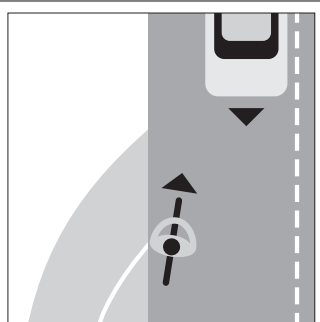

At path's end, bicyclists going against traffic may continue riding wrong way.

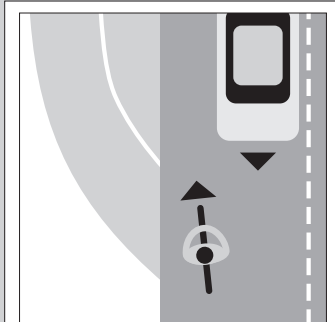

To get to a path entrance, bicyclists may ride against traffic or make unanticipated crossings..

Wrong-way bicycling is a major cause of bicycle/motor vehicle crashes and should be discouraged at every opportunity.

3. Visibility and Applicability of Traffic Controls

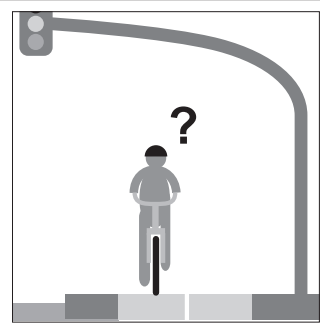

The traffic signals and signs will be backwards for the contra-flow bicycle traffic.

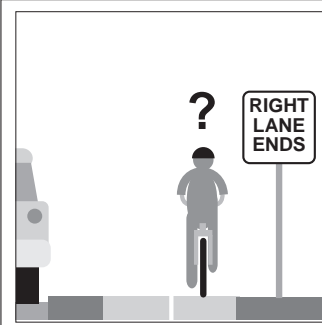

The road-oriented traffic signs may cause bicyclists confusion.

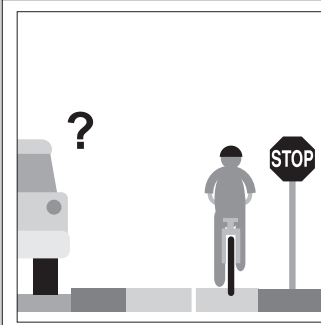

The path-oriented traffic signs may cause motorists confusion.

Two-way path traffic on one side of the roadway can make traffic controls more confusing to both bicyclists and motorists.

4. Maintenance and Limits on Available Space

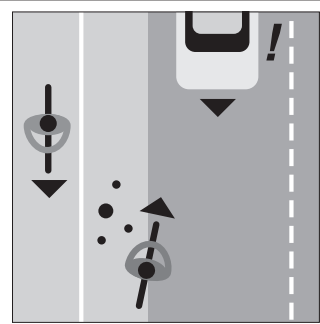

Contraflow bicyclists may swerve into the road to avoid debris or wayward path users.



Barriers, while needed in tight spaces, can narrow both roadway and path and create hazards.

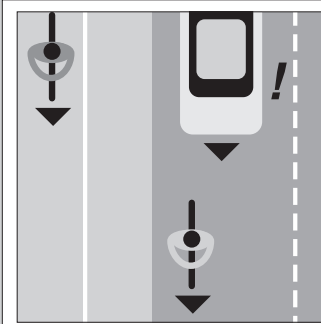

Some bicyclists may find the road cleaner, safer, and more convenient, frustrating some motorists.

Maintenance problems and inadequate space can add to the potential hazards of paths next to roadways.

For the above reasons, other types of bikeways are likely to be better suited to accommodate bicycle traffic along highway corridors, depending upon traffic conditions. Shared-use paths should **not** be considered a substitute for street improvements. Even where the path is located adjacent to the highway, many bicyclists will avoid it. They may find it less convenient, difficult to access from the direction they are traveling, and, perhaps, even unsafe at their speed to ride on these paths compared with the streets, particularly for utility trips.



Figure 4-3: A path next to an arterial street. Bicyclists on the path are required to stop at each minor cross street.

The path should have the same priority through intersections as the parallel highway (see Wisconsin State Statute 346.803(1)(b), Appendix C). Requiring or encouraging bicyclists to yield or stop at each cross-street or driveway (fig. 4-3) is inappropriate and frequently ignored. Excessive and improper traffic controls breed disrespect for ALL traffic controls on trails, even where clearly warranted.

If the right-of-way is too narrow to accommodate all highway and shared-use path features, consideration may be given to reducing existing or proposed widths of the various highway (and bikeway) elements (i.e., lane and shoulder widths, etc.). But

reductions to less than applicable design criteria must be documented by an engineering analysis.

If a two-way shared-use path must be located adjacent to a roadway, a wide separation between the path and the adjacent highway (fig. 4-4) is desirable to demonstrate that the path functions as an independent facility for bicyclists and others. Additionally, the inside bicyclist will be riding directly opposed to oncoming motor vehicle traffic. This often increases average closing speeds by up to 30 mph (compared to bicyclists riding with traffic).

Figure 4-4: A minimum 5ft. (1.5 m) shoulder is required between roadway and shared-use path, unless a barrier is provided.

The minimum separation is 5 ft. (1.5 m) between the edge of the paved shoulder and the path (fig. 4-4); preferably, the path should be located outside of the roadway's clear zone. When the 5-ft. separation is not possible, a suitable physical barrier is recommended (fig. 4-5). Such barriers prevent path users and motorists from making unwanted movements between the path and the highway shoulder (and vice versa) and reinforce the concept that the path is an independent facility. Where a barrier or a space separation is not possible narrowing the 5 ft. of separation area to 3 ft. for a short distance (several hundred feet)

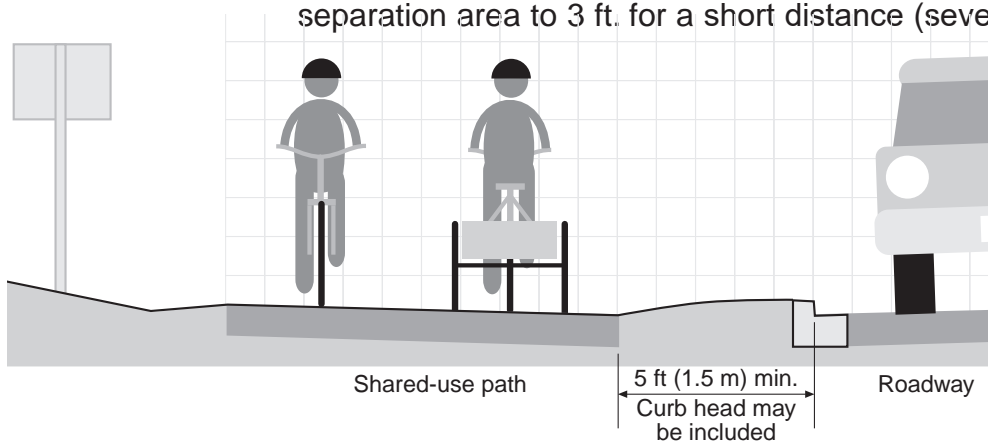

is acceptable. [This may be necessary at intersection approaches.] Three feet of separation for a longer stretch would be permitted if the path is next to a wide shoulder or bike lane.

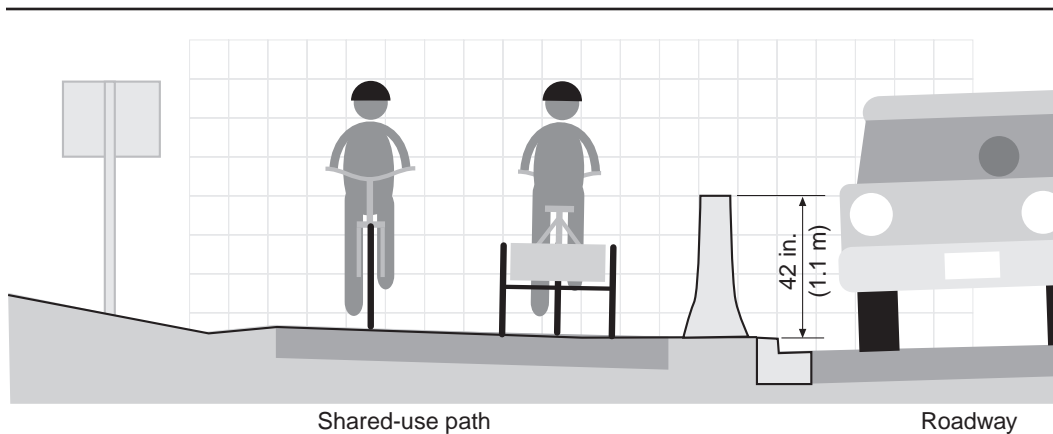

Figure 4-5: Where separation distance between the path and the roadway is inadequate, a barrier should be installed.

Where used, the vertical barrier should be a minimum of 42 in. (1.1 m) high in nearly all situations to prevent bicyclists from toppling over, unless the roadway has a shoulder or bicycle lane along with slow speeds and low volumes. A barrier between a shared-use path and adjacent highway should not impair sight distance at intersections, and should be designed to not be a hazard to errant motorists.

Figure 4-6: Designating sidewalks as bikeways ensures conflicts with the sidewalk's legitimate users.

4.3.2 Sidewalk bikeways

Some early bikeway systems used sidewalks for both pedestrians and bicyclists. In general, this practice should be avoided since the design speed for a sidewalk is significantly less than for a shared-use path. In rare instances such facilities may be necessary, or desirable (i.e., for use by small children or on a bridge; see Section 2.9 for more information on bridges). Sidewalks are generally not suited for cycling for numerous reasons:

- bicyclists face conflicts with pedestrians;
- sidewalks harbor hazards like utility poles, sign posts, benches, etc.;
- bicyclists face conflicts at driveways, alleys, and intersections; on sidewalks, they are often not visible to motorists and emerge unexpectedly. This is especially true if they ride against adjacent motor vehicle traffic: drivers do not expect vehicles on the wrong side; and
- bicyclists are put into awkward situations at intersections where they cannot safely act like vehicle drivers but are not in the pedestrian flow either, creating confusion for other road users.



Over all, bicyclists are safer when allowed to use the roadway as vehicle operators, rather than using the sidewalk as pedestrians. Where constraints do not allow full-width walkways and on-road bicycle lanes, solutions should be sought to create space for bicyclists AND pedestrians (e.g. by narrowing or eliminating motor vehicle lanes or on-street parking). In some urban situations, preference may be given to accommodating pedestrians. Sidewalks should not be signed for bicycle use — the choice should be left to the users. Wisconsin state statutes prohibit bicycling on sidewalks unless permitted by local ordinance on a community-wide or selective basis for certain sidewalk segments.

Figure 4-7 Some of the possibilities for bicycle-motor vehicle conflicts created by a median shared-use path

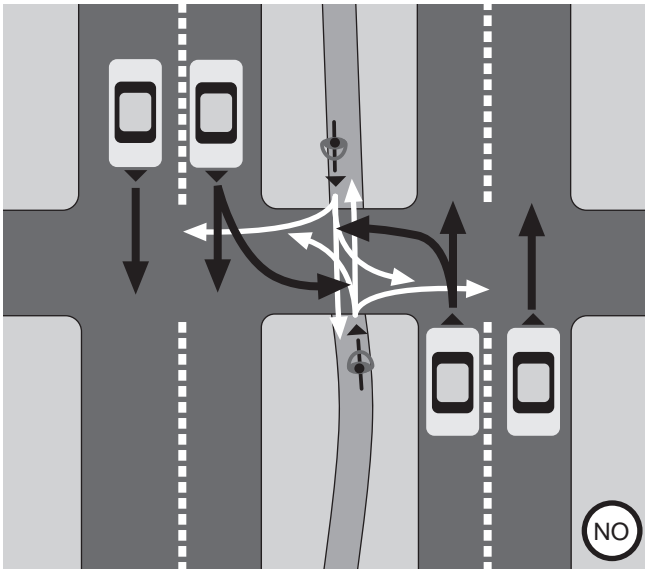

4.3.3 Shared-use paths in roadway medians

As a general rule, shared-use paths in the medians of highways, expressways, or boulevards are not recommended (fig. 4-7). They require bicyclists to operate in ways contrary to the normal rules of the road. Specific problems with such facilities include:

- proper bicyclist movements through signalized intersections are unclear;
- left-turning motorists cross one direction of motor vehicle traffic and two directions of bicycle traffic, increasing conflicts;
- bicyclist right turns from the center of the roadway are unnatural for bicyclists and confusing to motorists;
- where intersections are infrequent, bicyclists will enter or exit paths at mid-block; and
- where medians are landscaped, visual relationships between bicyclists and motorists at intersections are impaired.

For the above reasons, bikeways in the medians of non-access-controlled roadways should be considered only when the above problems can be avoided. Shared-use paths should only be provided in the medians of freeways or expressways if crossings can be avoided.

4.4. Path width

The paved width required for a shared-use path is a primary design consideration. Figure 4-8 shows a shared-use path on a separate right of way. Under most conditions, the paved width for a two-way shared-use path is 10 ft (3.0 m).

Figure 4-8: The standard width of a shared-use path. In areas with greater potential use, adding extra width may be appropriate.

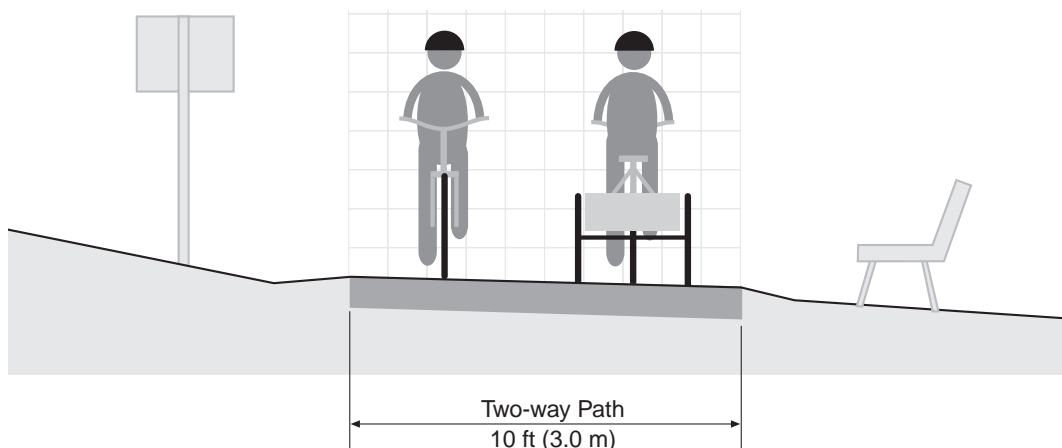

In rare instances, a reduced width of 8 ft (2.4 m) can be adequate. This reduced width should be used only where:

- *bicycle traffic is expected to be low, even during peak days or peak hours;*
- *only occasional pedestrian use is expected;*
- *good horizontal and vertical alignment will provide safe and frequent passing opportunities;*
- *the path will not be subjected to loading from standard maintenance vehicles that could ravel pavement edges;*
- *the path is very short (e.g., one connecting two cul-de-sac streets); and*
- *the path connects the main path to neighborhood.*

Figure 4-9: Paths in popular areas may need to be wider than normal to handle the increased traffic. Note: Helmets are recommended for all bicyclists.

In many cases, there may be enough potential use to warrant increasing path width to 12 ft (3.6 m), or even 14 ft (4.2 m). Paths in popular parks (fig. 4-9), along regional shorelines, or near large population centers and universities can easily generate high levels of mixed use traffic, attracting bicyclists, joggers, skaters and pedestrians. In addition, the sizes of maintenance and emergency vehicles and presence of steep grades should be taken into account (see Section 4.8 for more information about grades and widths).



The minimum width of a one-directional shared-use path is 6 ft (1.8 m). However, one-way paths will often be used in both directions (fig. 4-10) unless special precautions are taken in trail design and management.

In general, shared-use paths should be designed as two-way facilities.

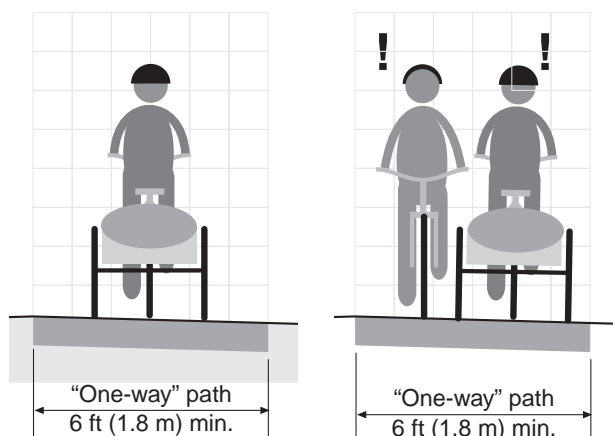

Figure 4-10: One-way paths are often used in two directions unless paired with another nearby one-way path.

Figure 4-11: Maintaining adequate shoulders and proper clearances between the path and obstacles preserves the path's effective width.

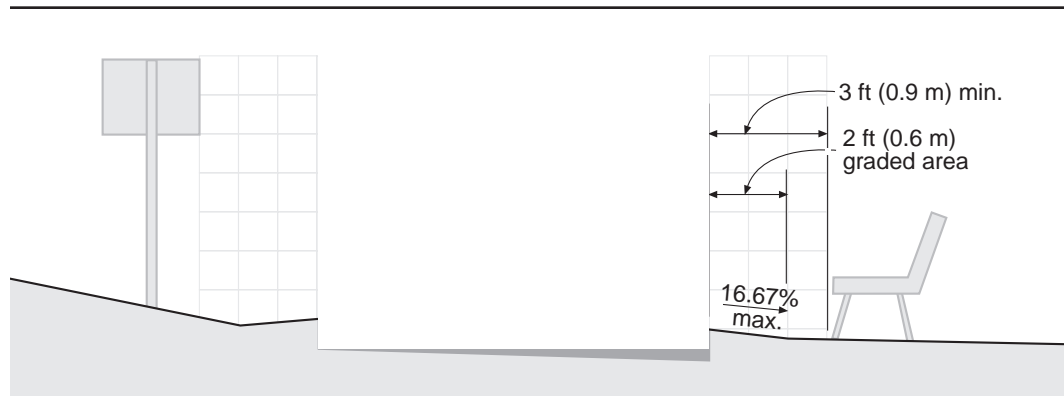

Figure 4-12: Object markings and warning signs should be used where clearances are tight.

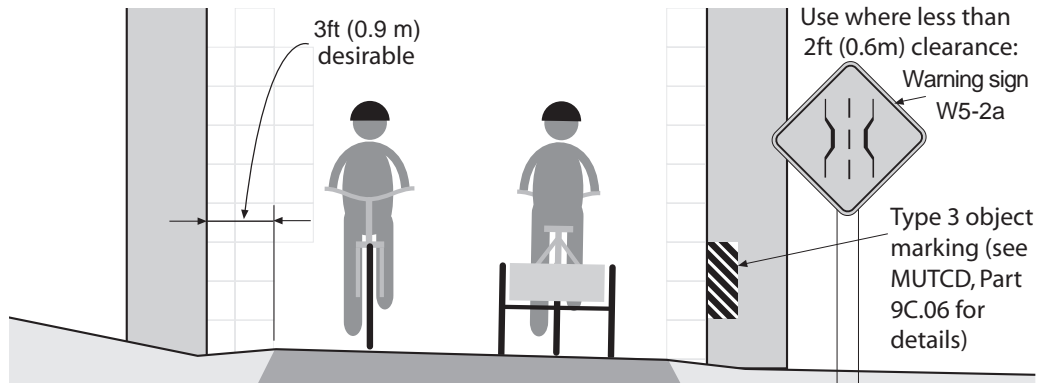

Figure 4-13: Good clearance increases effective path width and makes maintenance less difficult.



4.5 Shoulders and clearances

Shoulders: A minimum 2 ft (0.6 m) wide graded shoulder flatter than 1:6 (16.67%) slope should be maintained on both sides of the path (figs. 4-11, 4-13). Such shoulders provide a measure of safety, in case a bicyclist drifts off the side of the path. The shoulder surface should be level with the edge of pavement, to prevent crashes caused by an uneven pavement edge.

Clearances: Clearances are important for two reasons. The first is to provide adequate clearance from trees, posts, abutments, piers, poles, box culverts, guardrails, or other potential hazards. The second reason is to make maintenance (e.g., mowing) easier. A clear zone of 3 ft (0.9 m) or more is desirable on each side of a shared-use path.

However, a 1 to 2 ft (0.9 m – 1.8 m) clearance may be used where the obstruction is continuous, as with a long section of wall, a railing, or a fence. The ends of continuous obstructions or barriers should be flared at either end, especially where there is less than a 3 ft clearance from the path to the obstruction/barrier.

If adequate clearance cannot be maintained between the path and vertical obstructions or other features that narrow the clear zone, a warning sign (fig. 4-12) should be used in advance of the hazard with a Type 1, 2, or 3 object marker at its location (see Part 9C.06 of the MUTCD). This treatment should be used only where the hazard is unavoidable, and is by no means a substitute for good design.

Where the path is next to a canal or ditch, with a sloped drop-off steeper than 3:1 as shown in Figure 4-14, a wider separation should be considered. A minimum 5 ft (1.5 m) separation from the edge of the path pavement to the top of the slope or a safety rail should be provided where the slope/drop conditions in Figure 4-14 cannot be met. Depending on the height of embankment and condition at the bottom, a physical barrier, such as a safety railing, dense shrubbery, or a chain link fence, may be needed at the top of the slope (fig. 4-14.).

The vertical clearance to obstructions (fig. 4-15) should be 10 ft (3 m) for bicyclists' comfort and to allow access for maintenance and emergency vehicles. In only exceptional cases where the 10' standard is unattainable, can 8 ft (2.5 m) be used; while uncomfortable for some users, this height allows bicyclists to go under without hitting their heads. The Wisconsin Department of Natural Resources uses a 12-ft (3.6 m) vertical clearance on state trails to accommodate maintenance and snow grooming equipment.

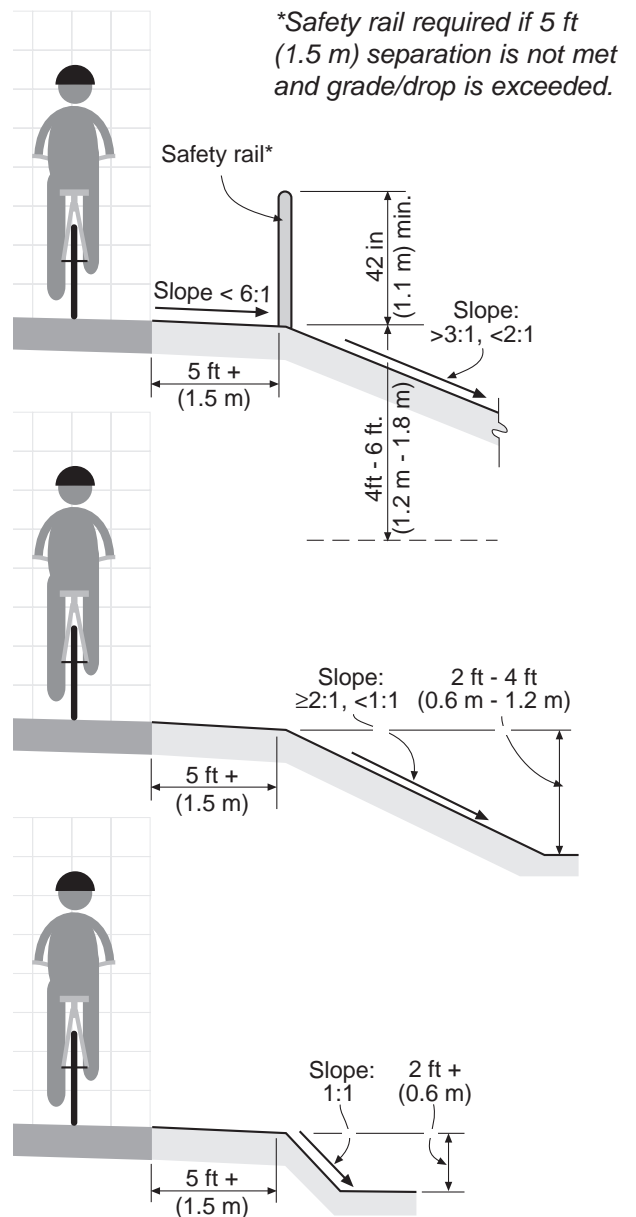

Figure 4-14: Paths next to slopes should be evaluated to determine if mitigation measures are needed.

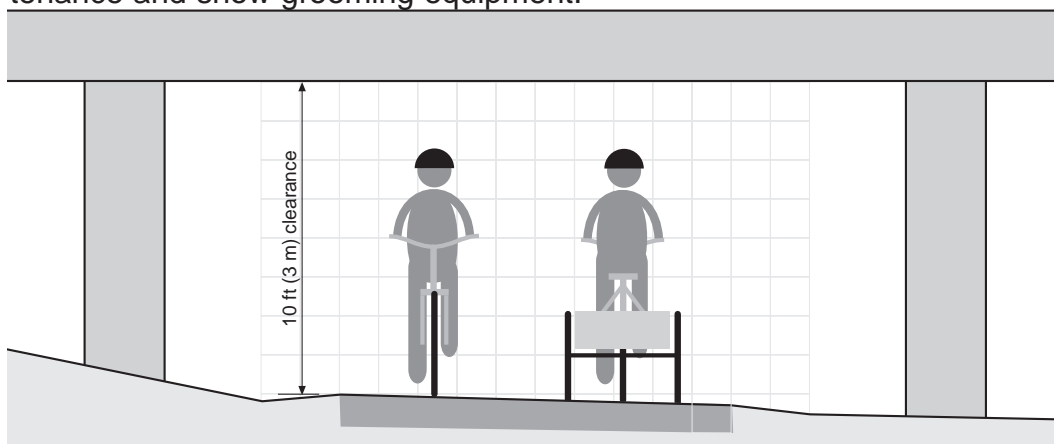

Figure 4-15: Vertical clearance requirements are based, in part, on the need for emergency vehicle access.

Figure 4-16: Using an adequate design speed means better visibility at curves and a reduced potential for unexpected conflicts.



4.6 Design Speed

A bicyclist's speed is dependent on a number of factors, including:

- *type and condition of the bicycle;*
- *trip purpose;*
- *condition, location and grade of the path (fig. 4-17);*
- *speed and direction of any prevailing winds;*
- *number and types of users on the path; and*
- *physical condition of the bicyclist.*

Figure 4-17: Topographical features may require raising the design speed in some cases.



In general, a design speed of 18 mph (27 km/h) should be used, except on inclines where higher speeds can occur. The design speed should not be lower, except in rare circumstances where the context and user types support lower speed.

For paths on long downgrades (i.e., steeper than 4% and longer than 500 ft (150 m)), a design speed of 30 mph (50 km/h) or more is advisable (Section 4.8).

Although bicyclists can travel faster than these speeds, to do so would be inappropriate in a

mixed-use setting that includes young bicyclists, pedestrians, wheelchair users, and others. Young bicyclists, for example, may ride at 5 to 10 mph (7 - 15 km/h) and casual adult bicyclists may ride at 10 to 15 mph (15 - 22 km/h). Pedestrians and wheelchair users may travel at 2 to 4 mph (3 - 6 km/h).

Warning signs can be used to deter excessive bicyclist speed; and faster cyclists can be encouraged to use the roadway system. For example, a “Fast Bicyclist Bypass” can be developed on a nearby through street (fig. 4-18).

On the other hand, lower design speeds should not be selected to attempt to artificially lower user speeds. Lower design speeds should only be considered under special circumstances. For example, terrain constraints may preclude designing to the preferred design speed.

Note: *Installation of “speed bumps” or other similar surface obstructions or staggered gates, intended to slow bicyclists in advance of intersections or other geometric constraints, should not be used. These devices cannot compensate for improper design.*

On unpaved paths (fig. 4-19), where bicyclists tend to ride more slowly, a lower design speed of 15 mph (25 km/h) can be used. Similarly, where the grades or the prevailing winds dictate or if pavement is likely to be added in the future, a higher design speed of 25 mph (40 km/h) can be used. Since bicycles have a higher tendency to skid on unpaved surfaces, horizontal curvature design should take into account lower coefficients of friction (see Section 4.7).



Figure 4-18: A green information sign directing faster bicyclists to nearby roadway.



Figure 4-19: A popular unpaved shared-use path following an abandoned railroad line.

Figure 4-20: An example of a trail with gentle curves, good visibility, and clearances.



Figure 4-21: A bicyclist entering a curve. Note inside pedal is up in preparation for turning.



4.7 Horizontal alignment & superelevation

Background: Unlike an automobile, a bicycle turns by leaning rather than by steering (fig. 4- 21). Racing bicyclists use this to their advantage and often turn relatively sharp corners at speed, without losing traction and sliding out.

Casual bicyclists, however, usually prefer not to lean very far, and 15 – 20° is considered the maximum lean angle. In addition, if an unwary bicyclist pedals through a sharp turn and leans too far, the pedal may strike the ground. Although bicycles vary, this generally occurs when the lean angle reaches about 25° and the inside pedal is down (fig. 4-22).

Adult tricycles do not turn by leaning. Like cars and trucks, tricycles turn by steering. As a result, steeply banked paths pull slow-moving tricyclists toward the inside of the curve and can cause the rider to topple over.

The typical adult bicyclist is the design user for horizontal alignment. The minimum radius of horizontal curvature for bicyclists can be calculated using two different methods. One method uses “lean angle”, and the other method uses superelevation and coefficient of friction. As detailed below, in general, the lean angle method should be used in design, although there are situations where the superelevation method is helpful.

Shared-use paths built in the United States must also meet the requirements of the Americans with Disabilities Act (ADA). ADA guidelines require that cross slopes not exceed 2% to avoid the severe difficulties that greater cross slopes can create for people in wheelchairs or using walker or canes.

For most shared-use paths, superelevation should be limited to 2 – 3%. The cross slope helps with drainage and in curves, the path should slope to the inside. When transitioning a 3% superelevation, a minimum 25 ft (7.5 m) transition distance should be provided between the end and beginning of consecutive and reversing horizontal curves.

Curve radius design: Assuming an operator who sits straight in the saddle, a simple equation can determine the minimum radius of curvature for any given lean angle:

<p><i>For English Units:</i></p> $R = \frac{0.067 V^2}{\tan \emptyset}$ <p>Where: <i>R = Minimum radius of curvature (ft)</i> <i>V = Design Speed (mph)</i> <i>∅ = Lean angle from vertical (degrees)</i></p>	<p><i>For Metric Units:</i></p> $R = \frac{0.0079 V^2}{\tan \emptyset}$ <p>Where: <i>R = Minimum radius of curvature (m)</i> <i>V = Design Speed (km/h)</i> <i>∅ = Lean angle from vertical (degrees)</i></p>
--	--

As the lean angle approaches 20°, the minimum radius of curvature negotiable by a bicycle becomes a function of the path’s superelevation, the coefficient of friction between the bicycle tires and the surface, and the speed of the bicycle. For this situation, the minimum design radius of curvature can be derived from the following formula:

<p><i>For English Units:</i></p> $R = \frac{V^2}{15 \left(\frac{e}{100} + f \right)}$ <p>Where: <i>R = Minimum radius of curvature (ft)</i> <i>V = Design Speed (mph)</i> <i>e = Rate of superelevation (percent)</i> <i>f = Coefficient of friction</i></p>	<p><i>For Metric Units:</i></p> $R = \frac{V^2}{127 \left(\frac{e}{100} + f \right)}$ <p>Where: <i>R = Minimum radius of curvature (m)</i> <i>V = Design Speed (km/h)</i> <i>e = Rate of superelevation (percent)</i> <i>f = Coefficient of friction</i></p>
---	---

The coefficient of friction (f) depends upon speed; surface type, roughness, and condition; tire type and condition; and whether the surface is wet or dry. Friction factors used for design should be selected based

Figure 4-22: Bicycles turn by leaning. Too much lean can cause a “pedal strike.” Tricycles turn by steering.

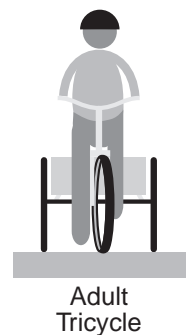
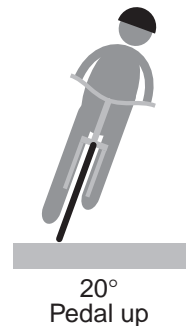
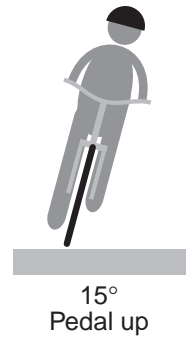
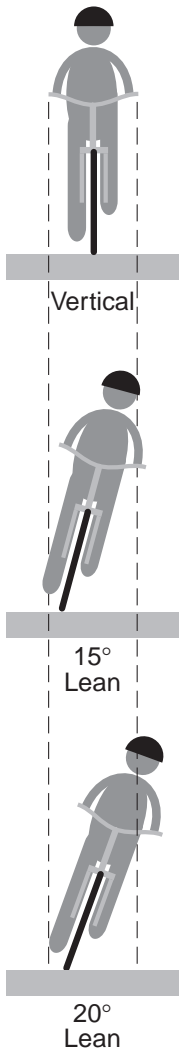

Figure 4-23
(below): A bicyclist has a greater effective width while leaning in a curve.



upon the point at which centrifugal force causes the bicyclist to recognize a feeling of discomfort and instinctively act to avoid higher speed.

Extrapolating from values used in highway design, friction factors for paved shared-use paths can be assumed to vary from 0.31 at 12 mph (20 km/h) to 0.21 at 30 mph (50 km/h). Although there are no data available for unpaved surfaces, reducing friction factors by 50% should allow a sufficient margin of safety.

Note: The formulas on page 4-15 are given for reference purposes. However the maximum desirable lean angle for a shared-use path is 20°.

One percent slopes are recommended on shared use paths where practical, because they are easier to navigate for people using wheelchairs. In most cases the lean angle formula should be used when determining the minimum radius of a horizontal curve, due to the need for relatively flat cross slopes and the fact that bicyclists lean when turning (regardless of their speed or the radius of their turn). The curve radius should be based upon various design speeds of 18 to 30 mph (29 to 48 km/h) and a desirable maximum lean angle of 20 degrees. Lower design speeds of 12 to 16 mph (19 to 26 km/h) may be appropriate under some circumstances (e.g., where environmental or physical constraints limit the geometrics). Minimum radii of curvature for a paved path can be selected from Table 4-1.

Table 4-1: Desirable Minimum Radii for Paved Shared Use Paths

Based on 20° Lean Angle Design

Speed (V)		Minimum Radius (R)	
mph	(km/h)	ft	(m)
18	(29)	60	(18)
20	(32)	74	(22)
25	(40)	115	(35)
30	(48)	166	(50)
<i>Special conditions (e.g., topography constraints):</i>			
12	(20)	27	(8)
14	(23)	36	(11)
16	(26)	47	(15)

(after AASHTO Guide for the Development of Bicycle Facilities, 2012)

Figure 4-24: A gentle curve combined with good sight distance.



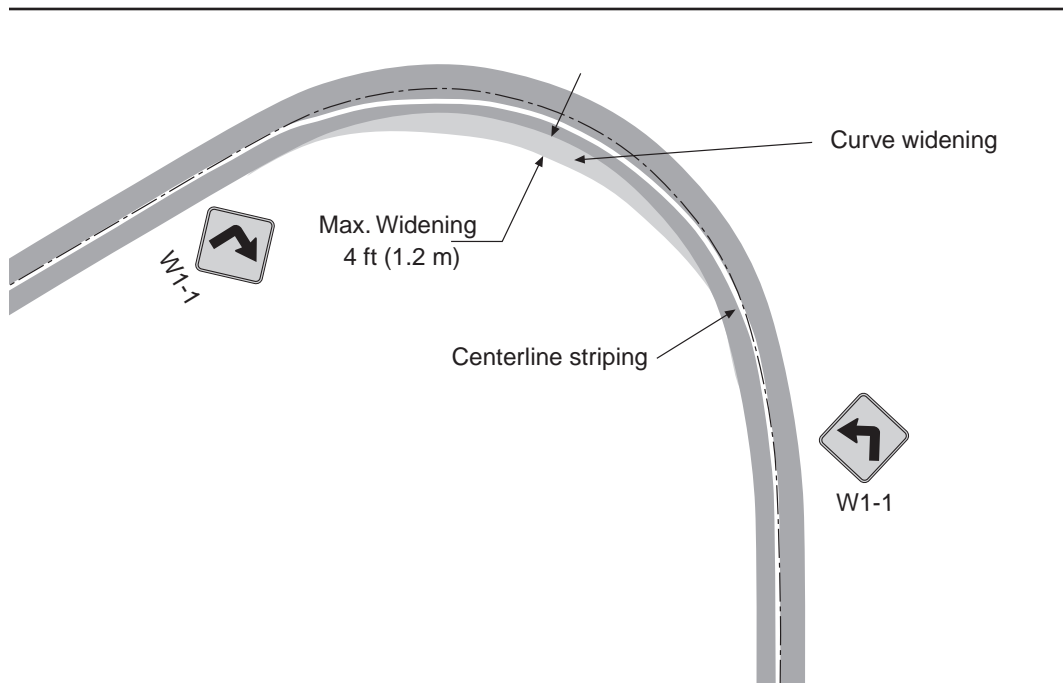

Figure 4-25: In tight curves, a centerline stripe can help keep bicyclists on the proper side. “Curve Ahead” (W1-1) warning signs and curve widening also help improve the curve’s safety.



Figure: 4-26: An example of centerline striping used in a curve to separate bicyclists going opposite directions. In this case, no curve widening was used, however vegetation has been trimmed back to improve sight lines.

In cases where substandard curve radii are unavoidable, curve warning signs, centerline striping (fig. 4-26), and curve widening should be used (fig. 4-25). Curve widening means increasing the width of the path through the curve and, as a result, modifying the radius. Typically, a center line is placed down the middle of the path and W1-1 warning signs may be used (fig. 4-25)

Figure 4-27:
Shared-use paths
should be
designed for all
ages. Grades
should be carefully
considered and
should be safe for
kids riding coaster
brake bicycles.



4.8 Grades

Shared-use paths generally attract less-skilled bicyclists, so it is important to avoid steep grades, to the extent possible (Table 4-2). Many bicyclists will find themselves walking on long, steep uphill grades. People with disabilities, especially those with stamina problems and using wheelchairs and walkers, will also have problems negotiating difficult grades. On downhills, bicyclists may exceed the speed at which they can safely control their bicycles. As a result, paths with long, steep grades are difficult for many bicyclists.

The maximum grade recommended for shared-use paths is 5%. Sustained grades should be limited to 2 or 3% if a wide range of riders is to be accommodated. The *AASHTO Guide for the Development of Bicycle Facilities* acknowledges that shared use paths are open to pedestrians, therefore grades on paths are to follow accessibility guidelines described in *ANPRM on Shared Use Paths*. Paths in independent rights-of-way the grades are to be 5% max. The ANPRM recognizes that certain conditions such as physical or regulatory constraints (e.g. existing terrain or infrastructure, historical features) may prevent full compliance; compliance is then required to the maximum extent. Where a shared-use path runs along a roadway the grade may match the roadway grade, when the roadway grade exceeds 5%, the path grade is to be less than or equal to the roadway grade. Refer to the U.S. Access Board for information on accessibility provisions for shared-use paths covered by ADA.

As a general guide, where steeper or longer grades cannot be avoided, the design speed should be increased and additional width should be provided for maneuverability.

Options to mitigate excessive grades:

- *On longer grades, widen path 4 to 6 ft (1.2 - 1.8 m) so slower speed bicyclists can dismount and walk;*
- *Use warning signs at the top to alert bicyclists to the grade (fig.4-28), with subplates with recommended descent speed;*
- *Increase stopping sight distances for the downhill direction;*
- *Increase horizontal clearances, add a recovery area, and/or protective railings;*
- *Widen path and add a series of short switchbacks to slow descending bicyclists (switchbacks should be near – or start at – the top of the hill, rather than at the bottom where speeds are likely to be greater).*
- *Provide resting intervals with flatter grades, to permit users to stop periodically.*
- *Use higher design speeds for horizontal and vertical curvature, stopping sight distance, and other geometric features.*

Unpaved paths: Grades steeper than 3% may not be practical for shared-use paths with crushed stone or other unpaved surfaces for both handling and drainage erosion reasons. Note: for recreational mountain bike trails grades (see the Bibliography for references).

4.9 Transitions between grades and level ground

While a 30 mph (50 km/h) design speed is suggested for grades, the design speed for level ground is 20 mph (30 km/h). Yet, it would be an error to use 20 mph as the design speed in determining the radius or the sight distance required for a curve at the bottom of a grade. Descending bicyclists will likely still be going faster for some way after they reach level ground. Similarly, stopping sight distance for an intersection at the bottom of a hill should reflect the higher speeds of entering bicyclists.

If the curve or intersection must be located at the bottom of a grade, the proper approach is to use 30 mph (50 km/h) as the design speed in determining curve radius or stopping sight distance.



W7-5

Figure 4-28: A warning sign for use in advance of steep path grades.

Figure 4-29: Bicyclists often enjoy going downhill; it's important to remember this while designing shared-use paths.

The run-out distance is a factor of the minimum stopping sight distance and minimum curve radii requirements of the curve that the bicyclist is about to enter at the end of the run-out (fig. 4-30). The bicyclist's anticipated "freewheeling speed" should be used for curve design. In unique circumstances where topographic and site characteristics limit the potential run-out length, the minimum run-out may be computed as the difference between the stopping sight distance for the grade and that for level ground.

Figure 4-30: Options for handling a curve at the bottom of hill.

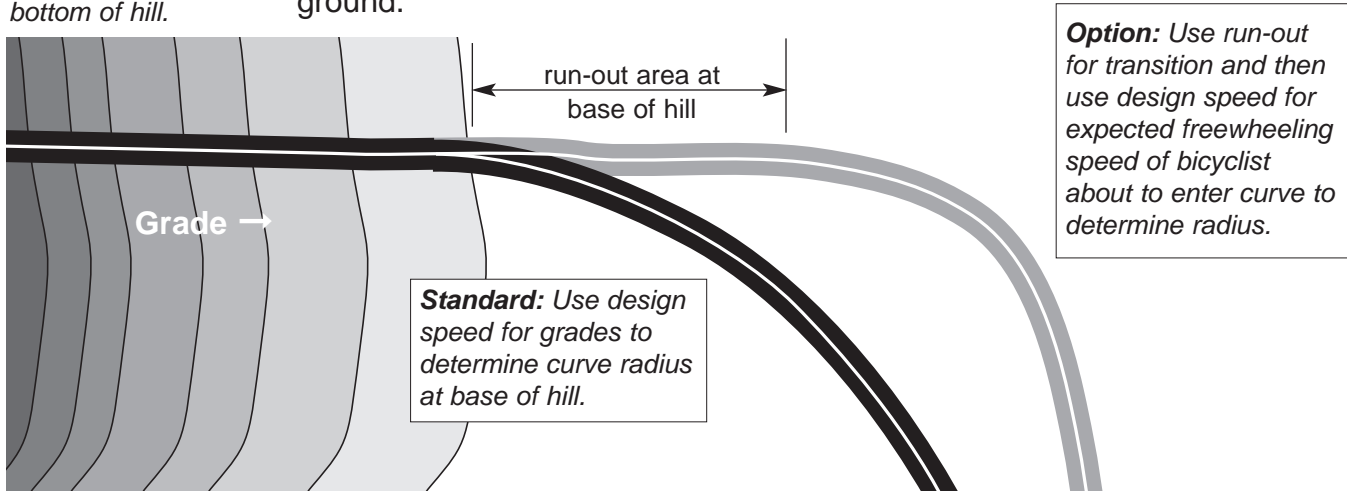

Where the minimum run-out is used, appropriate warning signage needs to be posted to warn cyclists that they need to begin slowing (within the run-out area) so they can safely negotiate an upcoming curve designed for a slower speed than they are currently traveling. For example, at 30 mph (50 km/h), the stopping sight distance is 225 ft (74m) and at 20 mph (30 km/h), the stopping sight distance is 125 ft (38m). The difference of 100 feet (30 m) would be the minimum run-out distance required to allow bicyclists to slow to the level grade design speed of 20 mph (30 km/h).

Figure 4-31: Overhanging bushes on the inside of this curve reduce sight distance and narrow the path.



Applying a run-out is also beneficial for paths leading to a stop or yield sign, although there is no formula to compute the minimum run-out. The minimum stopping sight distance would have to be met under these conditions.

4-10 Sight Distance

Shared-use paths should be designed with adequate stopping sight distances to let bicyclists see and react to the unexpected situations (fig. 4-31). The distance required to bring a bicycle to a full controlled stop is a function of the bicyclist's perception and brake reaction time; the initial bicycle speed; the coefficient of friction between the tires and pavement; and the braking ability of the bicycle and the bicyclist.

Figure 4-32 and 4-34 (below and on next page) indicate the minimum stopping sight distance for various design speeds and grades. These distances are based on a combined perception and brake reaction time of 2.5 seconds and a coefficient of friction of 0.25 to account for the poor wet weather braking characteristics of many bicycles. For two-way shared use paths, the sight distance in the descending direction, that is, where “G” is negative, will control the design.

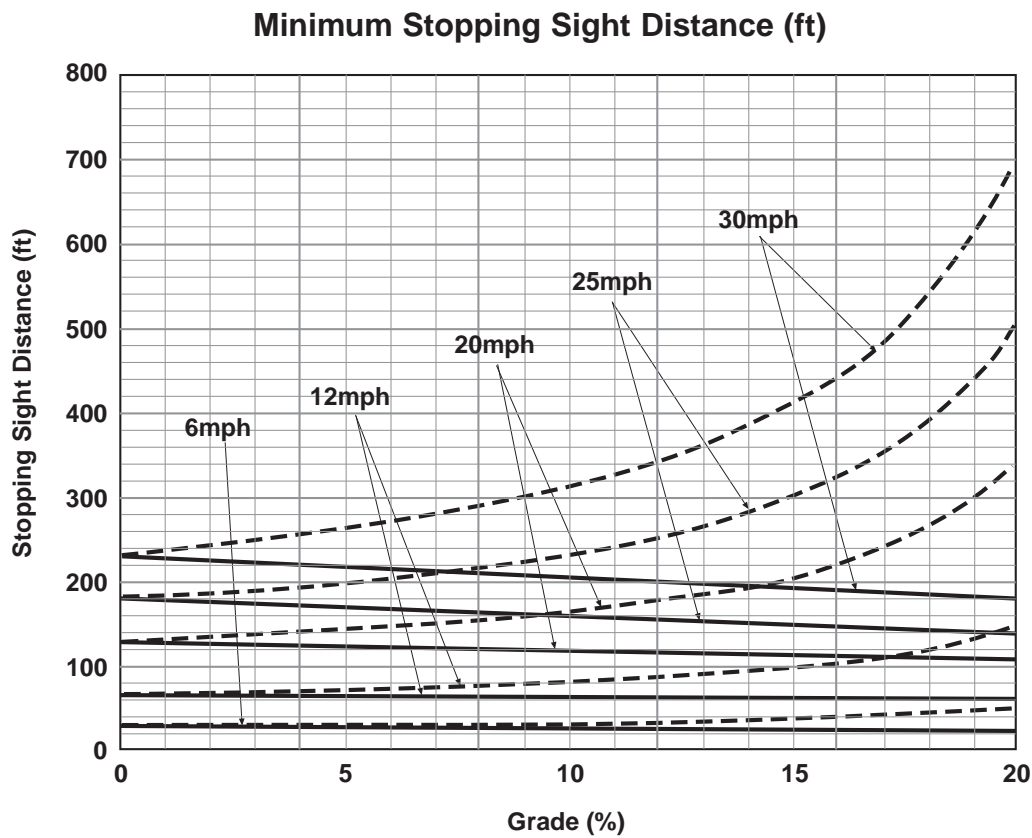

Figure 4-32: Minimum stopping sight distance is determined based on design speed and grade. (English units) (after AASHTO Guide for the Development of Bicycle Facilities, 1999)

$$S = \frac{V^2}{30(f \pm G)} + 3.67V$$

Where:
 S = Stopping sight distance (ft)
 V = Velocity (mph)
 f = Coefficient of friction (use 0.25)
 G = Grade (ft/ft) (rise/run)

Descend - - - - -
 Ascend ————

Example: Determine the Descending Stopping Sight Distance for a 4% grade. Assume a 30 mph speed and follow the dashed 30 mph line to where it intersects the vertical line for 4% (fig. 4-33). The result is 250 ft.

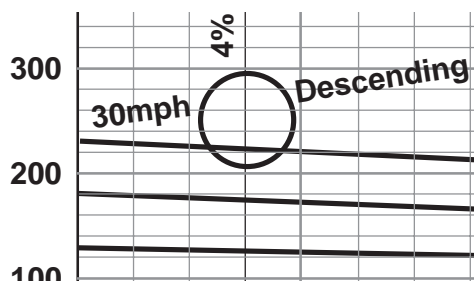
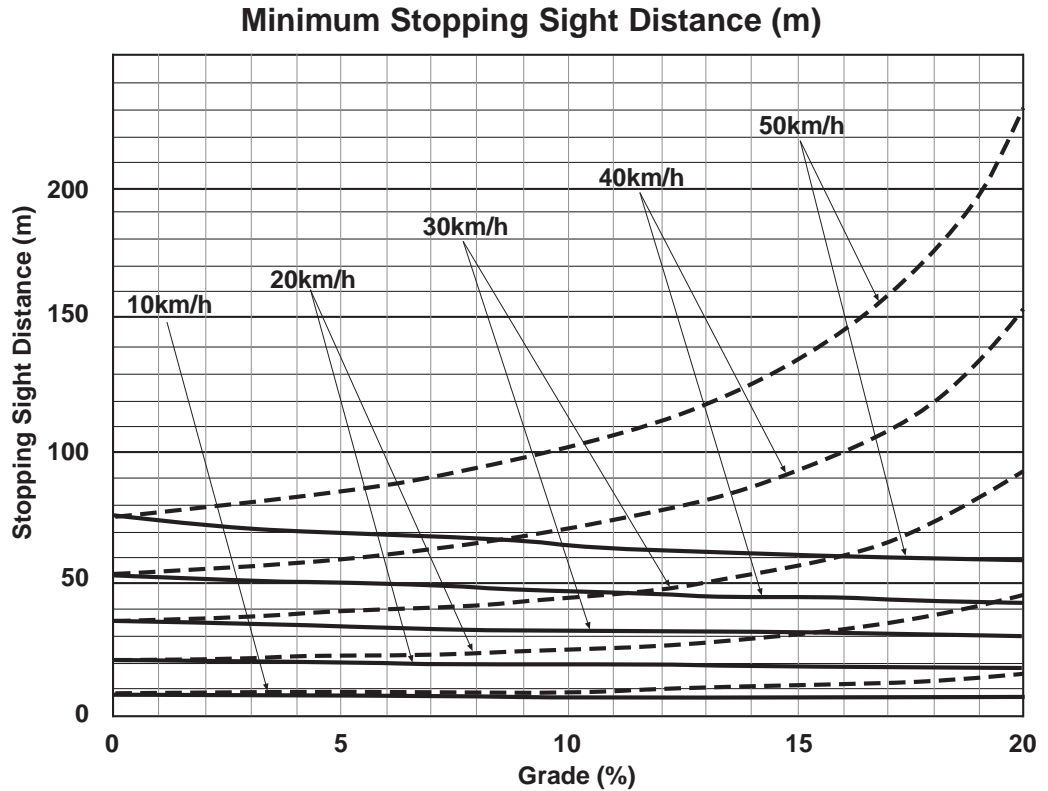

Figure 4-33: A close-up view of the graph in fig. 4-29, showing the intersection of the 30mph downhill line and the 4% grade line.

Figure 4-34: Minimum stopping sight distance is determined based on design speed and grade. (Metric units) (after AASHTO Guide for the Development of Bicycle Facilities, 1999)



$$S = \frac{V^2}{254(f \pm G)} + \frac{V^2}{1.4}$$

Where:

- S = Stopping sight distance (m)
- V = Velocity (km/h)
- f = Coefficient of friction (use 0.25)
- G = Grade (m/m) (rise/run)

Legend:
 Descend - - - -
 Ascend ————

Vertical curves: Tables 4-3 (English units) and 4-4 (Metric units) are used to select the minimum length of vertical curve necessary to provide sufficient stopping sight distance at various speeds on crest vertical curves. The bicyclist’s eye is assumed to be 4.5 ft (1.4 m) above the pavement. The object height is assumed to be 0 ft. (0 m) since obstacles are often found at pavement level. Use these two tables; however, an additional table showing *K factors*** is planned for the appendix of this guide.

Horizontal curves: The minimum lateral clearance for sight obstructions on horizontal curves is illustrated in figure 4-35. Tables 4-5 (English units) and 4-6 (Metric units) give those values, based on a selected curve radius and the stopping sight distance (taken from figures 4-32 (English) or 4-34 (Metric)). Bicyclists often ride side-by-side on shared-use paths. On paths they may ride near the center. This is also true if vegetation or other path-side obstructions encroach on the effective path width.

** **K factors:** relationship of speed to vertical curve lengths and grades

Table 4-3: Minimum Length (in feet) of Crest Vertical Curve (L)

(after AASHTO Guide for the Development of Bicycle Facilities, 1999)

		Based on Stopping Sight Distance														
		S = Stopping Sight Distance (ft)														
A (%)		20	40	60	80	100	120	140	160	180	200	220	240	260	280	300
2													30	70	110	150
3									20	60	100	140	180	220	260	300
4						15	55	95	135	175	215	256	300	348	400	
5					20	60	100	140	180	222	269	320	376	436	500	
6				10	50	90	130	171	216	267	323	384	451	523	600	
7				31	71	111	152	199	252	311	376	448	526	610	700	
8			8	48	88	128	174	228	288	356	430	512	601	697	800	
9			20	60	100	144	196	256	324	400	484	576	676	784	900	
10			30	70	111	160	218	284	360	444	538	640	751	871	1000	
11			38	78	122	176	240	313	396	489	592	704	826	958	1100	
12		5	45	85	133	192	261	341	432	533	645	768	901	1045	1200	
13		11	51	92	144	208	283	370	468	578	699	832	976	1132	1300	
14		16	56	100	156	224	305	398	504	622	753	896	1052	1220	1400	
15		20	60	107	167	240	327	427	540	667	807	960	1127	1307	1500	
16		24	64	114	178	256	348	455	576	711	860	1024	1202	1394	1600	
17		27	68	121	189	272	370	484	612	756	914	1088	1277	1481	1700	
18		30	72	128	200	288	392	512	648	800	968	1152	1352	1568	1800	
19		33	76	135	211	304	414	540	684	844	1022	1216	1427	1655	1900	
20		35	80	142	222	320	436	569	720	889	1076	1280	1502	1742	2000	
21		37	84	149	233	336	457	597	756	933	1129	1344	1577	1829	2100	
22		39	88	156	244	352	479	626	792	978	1183	1408	1652	1916	2200	
23		41	92	164	256	368	501	654	828	1022	1237	1472	1728	2004	2300	
24	3	43	96	171	267	384	523	683	864	1067	1291	1536	1803	2091	2400	
25	4	44	100	177	278	400	544	711	900	1111	1344	1600	1878	2178	2500	

when $S > L$ $L = 2S - \frac{900}{A}$

when $S < L$ $L = \frac{AS^2}{900}$

Shaded area represents $S = L$

L = Min. length of vertical curve (ft)
 A = Algebraic grade difference (%)
 S = Stopping sight distance (ft)

Height of cyclist eye = 4.5 ft
 Height of object = 0 ft
 Min. length of vertical curve = 3 ft

NOTE: For these reasons, and because of the higher potential for bicycle crashes, lateral clearances on horizontal curves should be calculated based on **the sum of the stopping sight distances** for bicyclists traveling in opposite directions around the curve.

Where adequate sight distance cannot be provided, mitigation measures like those described below can help:

- widen the path through the curve (see fig. 4-25);
- Install a solid yellow center line stripe (fig. 4-26);
- Install a “Curve Ahead” warning sign (fig. 4-25); or
- Some combination of the above.

(after AASHTO Guide for the Development of Bicycle Facilities, 1999)

Table 4-4: Minimum Length (in meters) of Crest Vertical Curve (L)

		Based on Stopping Sight Distance																		
A		S = Stopping Sight Distance (m)																		
(%)		10	15	20	25	30	35	40	45	50	55	60	65	70	75	80	85	90	95	100
2															10	20	30	40	50	60
3										7	17	27	37	47	57	67	77	87	97	107
4							10	20	30	40	50	60	70	80	91	103	116	129	143	
5					4	14	24	34	44	54	64	75	88	100	114	129	145	161	179	
6				3	13	23	33	43	54	65	77	91	105	121	137	155	174	193	214	
7				10	20	30	40	51	63	76	90	106	123	141	160	181	203	226	250	
8			5	15	25	35	46	58	71	86	103	121	140	161	183	206	231	258	286	
9			9	19	29	39	51	65	80	97	116	136	158	181	206	232	260	290	321	
10		2	12	22	32	44	57	72	89	108	129	151	175	201	229	258	289	322	357	
11		5	15	25	35	48	63	80	98	119	141	166	193	221	251	284	318	355	393	
12		7	17	27	39	53	69	87	107	130	154	181	210	241	274	310	347	387	429	
13		8	18	29	42	57	74	94	116	140	167	196	228	261	297	335	376	419	464	
14		10	20	31	45	61	80	101	125	151	180	211	245	281	320	361	405	451	500	
15	1	11	21	33	48	66	86	108	134	162	193	226	263	301	343	387	434	483	536	
16	3	13	23	36	51	70	91	116	143	173	206	241	280	321	366	413	463	516	571	
17	4	14	24	38	55	74	97	123	152	184	219	257	298	342	389	439	492	548	607	
18	4	14	26	40	58	79	103	130	161	194	231	272	315	362	411	464	521	580	643	
19	5	15	27	42	61	83	109	137	170	205	244	287	333	382	434	490	550	612	679	
20	6	16	29	45	64	88	114	145	179	216	257	302	350	402	457	516	579	645	714	
21	7	17	30	47	68	92	120	152	188	227	270	317	368	422	480	542	608	677	750	
22	7	18	31	49	71	96	126	159	196	238	283	331	385	442	503	568	636	709	786	
23	8	18	33	51	74	101	131	166	205	248	296	347	403	462	526	593	665	741	821	
24	8	19	34	54	77	105	137	174	214	259	309	362	420	482	549	619	694	774	857	
25	9	20	36	56	80	109	143	181	223	270	321	377	438	502	571	645	723	806	893	

when $S > L$ $L = 2S - \frac{280}{A}$ Shaded area represents $S = L$

when $S < L$ $L = \frac{AS^2}{280}$

Height of cyclist eye - 1.4 m
Height of object - 0 m

L = Min. length of vertical curve (m)
 A = Algebraic grade difference (%)
 S = Stopping sight distance (m)

Min. length of vertical curve = 1 m

Figure 4-35: Minimum Lateral Clearance (M) for Horizontal Curves (after AASHTO Guide for the Development of Bicycle Facilities, 1999)

Minimum Lateral Clearance (M) for Horizontal Curves

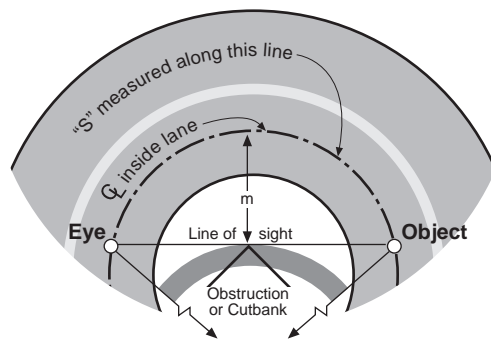

Line of sight - 700 m above centerline of inside lane at point of obstruction

$$M = R \left[1 - \cos\left(\frac{28.65S}{R}\right) \right]$$

$$S = \frac{R}{28.65} \left[\cos^{-1}\left(\frac{R-M}{R}\right) \right]$$

S = Stopping sight distance (m or ft)
 R = Radius of centerline of lane (m or ft)
 M = Dist. from centerline of lane to obstruction
Angle expressed in degrees
Formula applies when $S \leq$ length of curve

Table 4-5: Minimum Lateral Clearance (M) for Horizontal Curves*

R(ft)	(English Units)														
	S = Stopping Sight Distance (ft)														
	20	40	60	80	100	120	140	160	180	200	220	240	260	280	300
25	2.0	7.6	15.9												
50	1.0	3.9	8.7	15.2	23.0	31.9	41.5								
75	0.7	2.7	5.9	10.4	16.1	22.8	30.4	38.8	47.8	57.4	67.2				
95	0.5	2.1	4.7	8.3	12.9	18.3	24.7	31.8	39.5	48.0	56.9	66.3	75.9	85.8	
125	0.4	1.6	3.6	6.3	9.9	14.1	19.1	24.7	31.0	37.9	45.4	53.3	61.7	70.6	79.7
155	0.3	1.3	2.9	5.1	8.0	11.5	15.5	20.2	25.4	31.2	37.4	44.2	51.4	59.1	67.1
175	0.3	1.1	2.6	4.6	7.1	10.2	13.8	18.0	22.6	27.8	33.5	39.6	46.1	53.1	60.5
200	0.3	1.0	2.2	4.0	6.2	8.9	12.1	15.8	19.9	24.5	29.5	34.9	40.8	47.0	53.7
225	0.2	0.9	2.0	3.5	5.5	8.0	10.8	14.1	17.8	21.9	26.4	31.3	36.5	42.2	48.2
250	0.2	0.8	1.8	3.2	5.0	7.2	9.7	12.7	16.0	19.7	23.8	28.3	33.1	38.2	43.7
275	0.2	0.7	1.6	2.9	4.5	6.5	8.9	11.6	14.6	18.0	21.7	25.8	30.2	34.9	39.9
300	0.2	0.7	1.5	2.7	4.2	6.0	8.1	10.6	13.4	16.5	19.9	23.7	27.7	32.1	36.7
350	0.1	0.6	1.3	2.3	3.6	5.1	7.0	9.1	11.5	14.2	17.1	20.4	23.9	27.6	31.7
390	0.1	0.5	1.2	2.1	3.2	4.6	6.3	8.2	10.3	12.8	15.4	18.3	21.5	24.9	28.5
500	0.1	0.4	0.9	1.6	2.5	3.6	4.9	6.4	8.1	10.0	12.1	14.3	16.8	19.5	22.3
565		0.4	0.8	1.4	2.2	3.2	4.3	5.7	7.2	8.8	10.7	12.7	14.9	17.3	19.8
600		0.3	0.8	1.3	2.1	3.0	4.1	5.3	6.7	8.3	10.1	12.0	14.0	16.3	18.7
700		0.3	0.6	1.1	1.8	2.6	3.5	4.6	5.8	7.1	8.6	10.3	12.0	14.0	16.0
800		0.3	0.6	1.0	1.6	2.2	3.1	4.0	5.1	6.2	7.6	9.0	10.5	12.2	14.0
900		0.2	0.5	0.9	1.4	2.0	2.7	3.6	4.5	5.6	6.7	8.0	9.4	10.9	12.5
1000		0.2	0.5	0.8	1.3	1.8	2.4	3.2	4.0	5.0	6.0	7.2	8.4	9.8	11.2

(after AASHTO Guide for the Development of Bicycle Facilities, 1999)

Table 4-6: Minimum Lateral Clearance (M) for Horizontal Curves*

R(m)	(Metric Units)																		
	S = Stopping Sight Distance (m)																		
	10	15	20	25	30	35	40	45	50	55	60	65	70	75	80	85	90	95	100
10	1.2	2.7	4.6	6.8	9.3														
15	0.8	1.8	3.2	4.9	6.9	9.1	11	14											
20	0.6	1.4	2.4	3.8	5.4	7.2	9.2	11	14	16	19								
25	0.5	1.1	2	3.1	4.4	5.9	7.6	9.5	11	14	16	18	21	23					
50	0.3	0.6	1	1.6	2.2	3	3.9	5	6.1	7.4	8.7	10	12	13	15	17	19	21	23
75	0.2	0.4	0.7	1	1.5	2	2.7	3.4	4.1	5	5.9	6.9	8	9.2	10	12	13	15	16
100	0.1	0.3	0.5	0.8	1.1	1.5	2	2.5	3.1	3.8	4.5	5.2	6.1	7	7.9	8.9	10	11	12
125	0.1	0.2	0.4	0.6	0.9	1.2	1.6	2	2.5	3	3.6	4.2	4.9	5.6	6.3	7.2	8	8.9	9.9
150		0.2	0.3	0.5	0.7	1	1.3	1.7	2.1	2.5	3	3.5	4.1	4.7	5.3	6	6.7	7.5	8.3
175		0.2	0.3	0.4	0.6	0.9	1.1	1.4	1.8	2.2	2.6	3	3.5	4	4.6	5.1	5.8	6.4	7.1
200		0.1	0.3	0.4	0.6	0.8	1	1.3	1.6	1.9	2.2	2.6	3.1	3.5	4	4.5	5	5.6	6.2
225		0.1	0.2	0.3	0.5	0.7	0.9	1.1	1.4	1.7	2	2.3	2.7	3.1	3.5	4	4.5	5	5.5
250		0.1	0.2	0.3	0.5	0.6	0.8	1	1.2	1.5	1.8	2.1	2.4	2.8	3.2	3.6	4	4.5	5
275		0.1	0.2	0.3	0.4	0.6	0.7	0.9	1.1	1.4	1.6	1.9	2.2	2.6	2.9	3.3	3.7	4.1	4.5
300			0.2	0.3	0.4	0.5	0.7	0.8	1	1.3	1.5	1.8	2	2.3	2.7	3	3.4	3.8	4.2

(after AASHTO Guide for the Development of Bicycle Facilities, 1999)

* Minimum lateral clearance should be measured from the centerline of the inside lane, as per Figure 4-35.

FDM 11-10-5 (figure 6) presents comparable data in a graph by various design speeds and stopping sight distances for roadway design purposes. A similar graph is planned for the appendix of this guide.



Figure 4-36: A smooth path surface is one element required for a safe bicycle ride.

4.11 Pavement structure

Designing and selecting pavement sections for shared use paths is in many ways similar to designing and selecting highway pavement sections. A soils investigation should be conducted to determine the load-carrying capabilities of the native soil, unimproved shoulder, or former railroad bed (if ballast has been removed), and the need for any special provisions. Table 4-7 shows some surface types, as well as their advantages and disadvantages.

Hard pavement surfaces are usually preferred over those of crushed aggregate, sand, clay or stabilized earth since these materials provide a lower quality of service and may require greater maintenance. In addition, such “soft” surfaces do not work well on paths intended for all-weather — and all-season — transportation use (e.g., commuting).

Rutting or other damage may occur on such paths that see heavy use in wet weather or during the spring thaw. Also, in areas subjected to flooding or drainage problems, or in areas of steep terrain, unpaved surfaces will often erode and are not recommended. Further, wheelchair users are not well-served by unpaved paths. Paths in or near communities, in particular, should be considered for paving, either with asphalt or concrete.

On the other hand, many of Wisconsin’s more recreation-oriented paths, particularly in rural areas, are surfaced with crushed aggregate (limestone and rotten granite). These path surfaces can reduce bicyclists’

Table 4-7: Path Surface Summary

<i>Surface Material</i>	<i>Advantages</i>	<i>Disadvantages</i>
Soil cement	Uses natural materials, more durable than native soils, smoother surface, low cost.	Surface wears unevenly, not a stable all-weather surface, erodes, difficult to achieve correct mix.
Crushed aggregate	Soft but firm surface, natural material, moderate cost (varies regionally), smooth surface, accommodates multiple use.	Surface can rut or erode with heavy rainfall, regular maintenance to keep consistent surface, replenishing stones may be a long-term expense, not for steep slopes.
Asphalt	Hard surface, supports most types of use, all weather, does not erode, accommodates most users simultaneously, low maintenance.	High installation cost, costly to repair, not a natural surface, freeze/thaw can crack surface, heavy construction vehicles need access.
Concrete	Hardest surface, easy to form to site conditions, supports multiple use, lowest maintenance, resists freeze/thaw, best cold weather surface.	High installation cost, joints must be sawn for smooth ride, costly to repair, not natural looking, construction vehicles will need access to the trail corridor.
Native soil	Natural material, lowest cost, low maintenance, can be altered for future improvements, easiest for volunteers to build and maintain.	Dusty, ruts when wet, not an all-weather surface, can be uneven and bumpy, limited use, inappropriate for bicycles and wheelchairs.
Recycled materials	Good use of recyclable materials, surface can vary depending on materials.	High purchase and installation cost, life expectancy unknown.

speeds. And, they have typically been built in less time and at lower cost than paths built with asphalt or concrete. However, the surface of choice in one part of the state may be expensive elsewhere. For example, limestone topped off with screenings is expensive in central and western Wisconsin. There, some agencies use rotten disintegrated granite while others have used seal coat treatments (e.g., Chippewa River Trail, Omaha Trail). Whichever material is available in a particular part of the state, it is fair to say that crushed aggregate is the preferred surface type for the majority of Wisconsin’s many “rail-trails.”



Figure 4-37: Pavement loads must take into account maintenance and emergency vehicles.

4.11.1 Pavement loads

While loads on shared use paths will be substantially less than those used in highway design, paths should hold up under the weight of occasional emergency, patrol, maintenance and other motor vehicles expected to use or cross the path (fig. 4-37). The pavement structure at highway or driveway crossings, in particular, should be adequate to sustain the expected loading at those locations.

Figure 4-38: Paving into unpaved roads or driveways that cross the path can help keep gravel off the path's surface.

When motor vehicles are driven on shared-use paths, their wheels will often be very near the edges of the path. They may occasionally go off the pavement and then come back on. This can cause the path edge to ravel, which, in turn, will reduce the path's effective width. For this reason, adequate edge support should always be provided. Building to the standard 10 ft (3.0 m) width can also help lessen the edge raveling and shoulder rutting problems, since motor vehicles will have an easier time staying on the path. Providing gravel shoulders, as recommended earlier, can also help, as can widening the path to 12 ft (3.6 m) or greater.

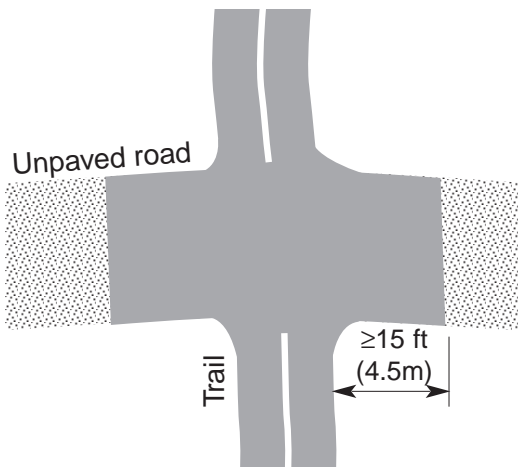

Where shared-use paths cross unpaved highways or driveways, the highway or driveway should be paved a minimum of 15 ft (4.5 m) on each side of the crossing to reduce the amount of gravel being scattered along the path by motor vehicles (fig. 4-38). Where the roadway descends a grade to the crossing, paving should be extended farther.

4.11.2 Vegetation Control

Vegetation control is generally considered the responsibility of a path's maintenance forces. However, to provide longer path life and lower maintenance costs, it should also be considered during design and construction (fig. 4-39).

The following are examples of vegetation control methods that may be useful during design and construction:

1. *Place a non-selective herbicide under the path.* All applications must be done according to label directions. The applicator must be licensed by the Wisconsin Department of Agriculture. It is common for thin bituminous surfaces with shallow subsurface treatments, such as walking trails, to be ruined by vegetation. This herbicide will prevent vegetation from penetrating the asphalt for a number of years. However, non-selective herbicides may injure nearby trees if their root systems grow into the treated area.

2. *Place a tightly woven geotextile or landscape fabric between the subgrade and base course.* This method may be used in sensitive areas where a non-selective herbicide is undesirable. It is also useful in areas with questionable soil conditions (e.g., a marsh or other wet area). Several brands of geotextiles provide additional structural support for the paving as well.

3. *Require selective vegetation removal or path realignment.* Trees or shrubs may encroach into the path's clear zone (fig. 4-40), reducing the path's effective width and stopping sight distance — and possibly causing bicycle crashes. Removing trees or shrubs that encroach or changing the path alignment can eliminate the problem.



Fig. 4-39: Weeds break through a relatively new path.



Fig. 4-40: Poor alignment reduces the effective width of this path.

4.11.3 Foundation preparation

Soil support and drainage conditions should be carefully evaluated prior to designing the pavement structure. This evaluation will identify areas needing special site corrections, such as unstable or unsuitable soil conditions that can be located and treated.

Figure 4-41:
Preparing shared-
use path subgrade.



Establishing a suitable foundation is essential to the success and longevity of the path. The following tasks should be included:

- *remove all unsuitable vegetation, topsoil, and other soils to the path's edge.* If trees are removed, all surface roots should be removed;
- *provide subgrade preparation to shape and compact the subgrade.* Provide subcut compaction and corrections as determined by the engineer;
- *place geotextile fabric on unstable soils if the engineer determines its use is appropriate.* The fabric should separate the aggregate base from unstable soils or sand; and
- *stabilize granular subgrades, if necessary.* Incorporate stabilizing aggregate into the upper portion of the subgrade to achieve adequate surface stability.



Figure 4-42: Machine-laid asphalt is smooth and a common surface for shared-use paths.

4.11.4 Asphalt structural section

Aggregate-based asphalt surfacing is generally recommended for paths (fig. 4-43). Full-depth bituminous may be considered where subgrade soils are relatively granular. It may be necessary to increase the pavement thickness where numerous heavy vehicles use or cross the path (at driveways, etc).

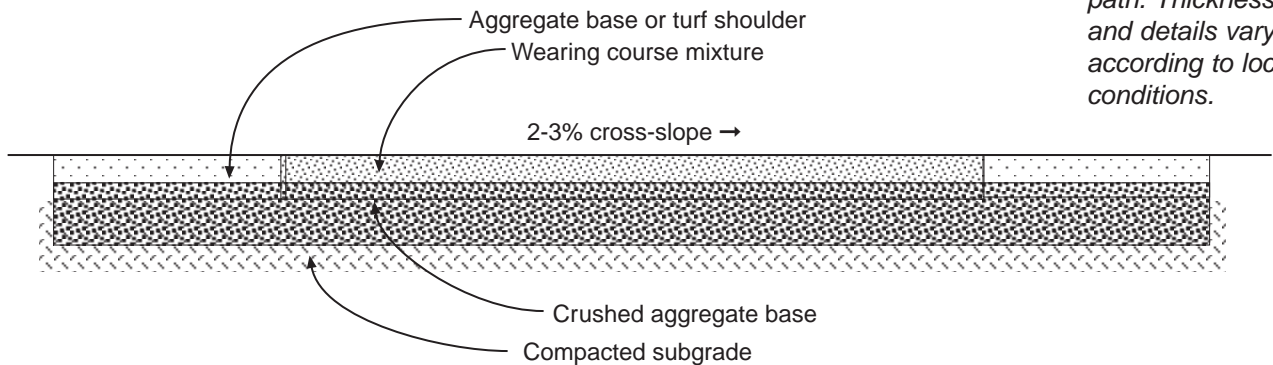

Figure 4-43: Cross section of asphalt path. Thickness and details vary according to local conditions.

Aggregate base should be increased in heavy soils where maintenance and emergency vehicles may cause pavement damage. Aggregate base thickness may be reduced for granular subgrade soils.

Figure 4-44:
Concrete can provide a smooth and long-lived surface, as shown on this shared-use path.



4.11.5 Concrete structural section

Portland cement concrete offers good rolling resistance, durable surface cohesion, and easy maintenance (fig. 4-45). Control joints can reduce riding comfort and complicate connections to existing surfaces. For riding comfort, and to minimize deterioration of the joint, transverse joints should be saw cut. A thicker paving section may be required where heavy vehicles use or cross the path. Each such location should be evaluated and the thickness increased if appropriate.

Figure 4-45: Cross section of concrete path. Thickness and details vary according to local conditions.

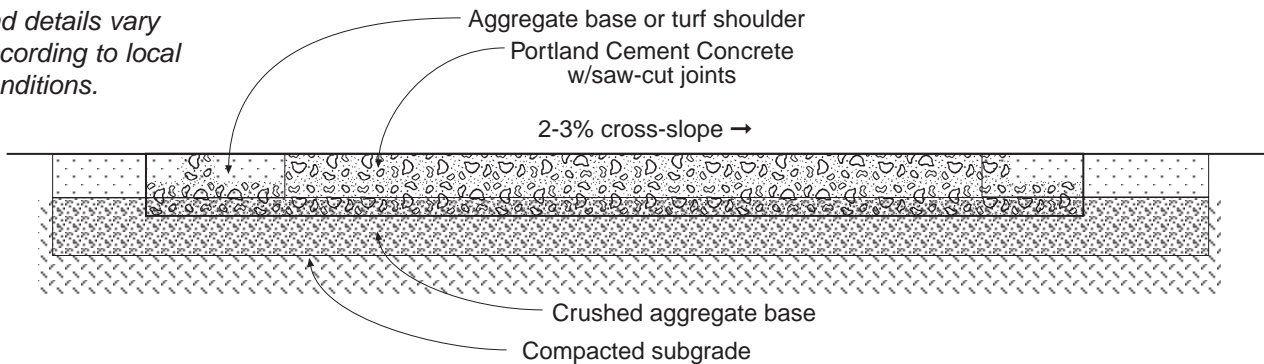

4.11.6 Aggregate structural section

Unpaved surfaces are best used where few formal traffic control measures are necessary and in natural settings. The Wisconsin Department of Natural Resources has built and maintains many miles of such paths (fig. 4-47), often following old railroad corridors. Depending on local availability, screened limestone or “rotten” granite are typically used. Crushed stone is easy to repair, does not crack and generally provides a comfortable riding surface. The popular wide-tired mountain bikes, as well as skinnier touring tires, are well-suited to such a path surface. It also integrates well into natural settings.



Figure 4-46: A crushed stone path often has a more natural appearance than pavement and is particularly good for trails following abandoned rail lines.

Some crushed stone surfaces lose cohesion with time, increasing the risk of skids. They may also be subject to erosion and vegetation encroachment. On limestone surfaces, wet weather may cause the limestone to emulsify, creating a spray from bicycle wheels which can coat the bicycle and rider. This can also be a problem for wheelchair users. And in dry weather, rising dust may hasten wear on bicycle mechanisms and make riding less pleasant. Overall, however, the surfaces work very well for recreational paths, particularly those in rural areas.

Figure 4-47: Cross section of aggregate path. Thickness and details vary according to local conditions.

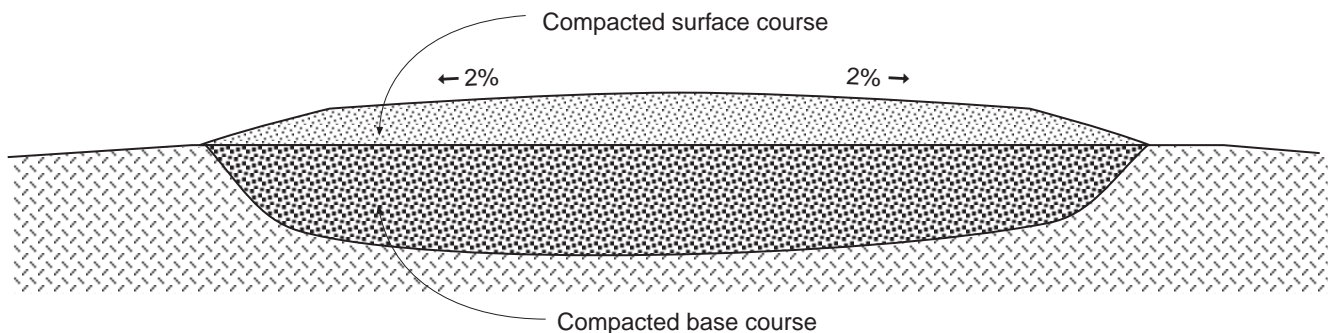

Grades greater than 5% should not be surfaced with crushed stone. These sections should be paved to prevent ruts and depressions.

Figure 4-48: Well-maintained path surfaces are important for all users.



4.11.7 Surface smoothness and maintenance

Paths should be built and maintained to provide a smooth riding surface. At the same time, skid resistance qualities should not be sacrificed for the sake of smoothness. On concrete, for example, broom finish or burlap drag surfaces are preferred. Consult with a district materials or soils engineer for recommendations on proper materials and construction.

Path surfaces tend to oxidize more rapidly than highway surfaces do. As a result, the use of surface treatments (Table 4-8) may help lengthen pavement life by slowing this process. Fine aggregate seal coats, for example, can give smooth asphalt surfaces if properly designed and can extend pavement life. Routine crack sealing is also an important factor.

Table 4-8 Surface Maintenance Treatments

<i>Surface Deterioration</i>	<i>Treatment</i>
Moderate (Slight Raveling)*	Slurry Seal (<i>aggregate, asphalt emulsion and fillers</i>)
Serious*	Overlay; seal cracks

* Localized areas that are seriously deteriorated should be reconstructed prior to application of the seal and/or placement of the overlay. Use of seal coats may not be desirable where in-line skating, etc. occurs.

4.12 Drainage

The recommended minimum pavement cross slope of 2% adequately provides for drainage. On curves, the cross slope should direct runoff to the inside, providing a slight amount of superelevation. Sloping in one direction usually simplifies longitudinal drainage design and surface construction, and is the preferred practice. However, some agencies prefer to crown concrete paths. And the Wisconsin Department of Natural Resources crowns its unpaved paths (see Section. 4-11-6).

Ordinarily, surface drainage from the path will be adequately dissipated as it flows down gently-sloping terrain. To this end, a smooth path surface and properly prepared shoulders are essential.

Where a shared-use path is constructed on the side of a hill, a drainage ditch of suitable dimensions should be placed on the uphill side to intercept hillside drainage. Such ditches should be offset from the pavement edge and designed with appropriate downslope from the path to the ditch (see fig. 4-14).

Where necessary, catch basins with drains should be provided to carry the intercepted water under the path. Drainage grates and manhole covers should be located outside the travel path of bicyclists. Any such structures that present a potential hazard should be offset at least 3 ft from the path edge and should be identified with hazard markings (see Fig. 4-49).

To assist in preventing erosion in the area adjacent to the shared use path, the design should include considerations for preserving the natural ground cover. Adjacent slopes should be seeded, mulched, and sodded.

On unpaved shared-use paths, particular attention should be paid to drainage to avoid erosion.

Figure 4-49: Hazard markers identify drainage structure adjacent to the path edge. If possible, such structures should be offset at least 3 feet from the edge of the path and covered with a bicycle-safe grate.





Figure 4-50: Path lighting is particularly important where ambient light levels change dramatically, as in an underpass.

4.13 Lighting

Fixed-source lighting improves visibility along paths and at intersections. In addition, lighting allows the bicyclist to see the path direction, surface conditions, and obstacles. Lighting for shared use paths is important and should be particularly considered where night usage is expected, such as on urban and suburban paths serving college students or commuters, especially those consistently serving both pedestrians and bicyclists. Even where lighting is not used for the path itself, lighting of intersections at trails and roadways should be strongly considered. Lighting should also be considered through underpasses or tunnels (fig. 4-50), overpasses, and where nighttime security could be an issue. Lighting is critical for path segments with sharp curves and grades, especially if those conditions do not meet other minimum AASHTO design requirements. This is common for ramps leading to overpasses or underpasses.

Figure 4-51: Path users need to see small obstacles and changes in surface to feel safe at night.

Shared-use path designers should take into consideration a number of lighting-related factors:



- **Night vision:** Both bicyclists and pedestrians have specific requirements for nighttime seeing. Both need to see small obstacles and changes in pavement surfaces to feel safe using paths at night. Uniform illumination should be provided that avoids “hot spots” and deep shadows, and care must be taken to avoid glare, which can compromise night vision.

- **Illumination levels:** Recommended light levels for shared-use paths are considerably lower than those for roadways and other outdoor lighting applications (see Table 4-9).

Table 4-9 Recommended Illumination for Shared-use Paths
Lux/Foot Candles
(from IESNA DG-5-1994, Table 2)

	Avg. Horizontal Illuminance Levels	Horizontal Avg:Min	Average Vertical Illuminance Levels	Vertical Avg:Min
Paths along streets:				
Commercial	10/1	4:1	20/2	5:1
Intermediate	5/0.5	4:1	10/1	5:1
Residential	2/0.2	10:1	5/0.5	5:1
Paths away from streets:				
	5/0.5	10:1	5/0.5	5:1

- **Luminaire Design:** Typical pole mounted roadway lights are a poor choice for illuminating narrow paths. Standard Type II horizontal lamps create spill light off the path, and require excess wattage and/or more frequent placement to maintain uniformity. If pole mounted lights are specified, Type I horizontal lamps should be used.



Figure 4-52: Type II horizontal lamps provide more light than is necessary.

- **Luminaire placement:** Uniformity of illumination is particularly important for shared-use paths. Bicyclists moving between “hot spots” from poorly placed luminaires may be unable to see in the interspersed shadows. Providing some overlap allows for a more constant visual environment, and can help prevent crashes.

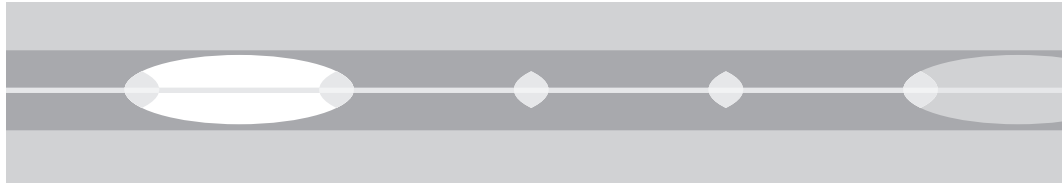
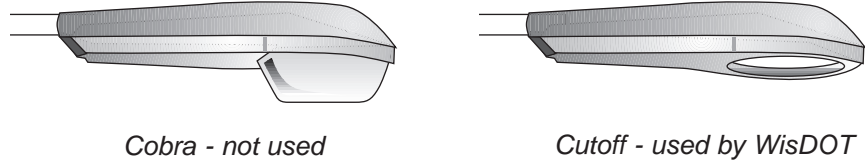

Figure 4-53: Properly spaced luminaires overlap to provide a more constant visual environment.

- **Full cutoff:** Glare from cobra-style luminaires should be avoided in all cases. Particular attention should be given to pathways adjacent to residences, waterways, or natural areas

where spill light and glare are unacceptable (fig. 4-54). Full cutoff luminaires are a minimum requirement for all path illumination, while special shielding may be required for more sensitive areas.

Figure 4-54: Cobra-style luminaires create spill light and glare and should not be used.



- **Bollards:** Lights mounted below eye level can also be used for illuminating shared-use paths (fig. 4-55). More frequent spacing, combined with lower wattage bulbs, can meet recommended levels of illuminance and uniformity while reducing operating costs.

Figure 4-55: Lights mounted in bollards can provide adequate illumination while reducing operating costs.

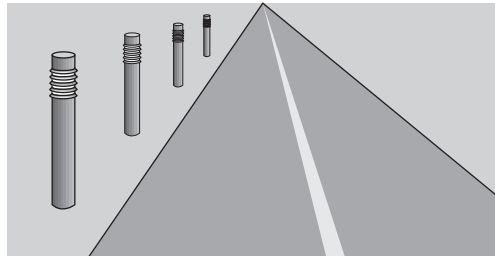

When choosing these fixtures, select a type that eliminates glare, since bicyclists' eye level will be just above these lights. These fixtures should be placed at least 2 ft (0.6 m) from the path edge.

- **Security:** The ability to recognize individuals and threats to security must also be considered when designing path lighting. Good security begins with recommended levels of illumination and uniformity, but also requires consideration of bulb type and light color. For example, low-pressure sodium bulbs, while energy efficient, provide poor color rendition and compromise the viewer's ability to recognize faces. Paths through high-risk areas may require additional area lighting to provide the user with a wider view for threat detection.

Where special security problems exist, higher illumination levels may be considered. Light standards (poles) should meet the recommended horizontal and vertical clearances identified in Figure 4-76. Luminaires and standards should be at a scale appropriate for a pedestrian (i.e., no taller than 15 ft (4.5 m)).

Note: Wisconsin State Statutes require front bicycle lights to be visible from at least 500 ft. There is no requirement for lights to illuminate the path and objects in front of a bicyclist. Many new bicycle lights are good at providing efficient lighting visible from long distances, but are relatively poor at illuminating the paths of bicyclists



Figure 4-56: Signing and marking paths are important elements of the overall design.

4.14 Signing and marking

Adequate signing and marking are essential on shared-use paths. And these elements fall into the same three main categories found in roadway signing and marking: regulatory, warning, and informational devices. Each category is associated with certain colors. Regulatory controls are associated with red, black, and white*; warning devices with yellow and fluorescent yellow-green; informational devices with blue, green and brown. *In striping, however, yellow is also a regulatory color.

4.14.1 Regulatory controls

Regulatory controls alert users to a legal condition that otherwise might not be obvious. Basically, they tell people what to do.

Dividing users: A 4-in (100 mm) yellow center line stripe (fig. 4-57) may be used to separate opposite directions of travel. Where passing is not permitted, a solid line may be used to separate the two directions of travel. This may be particularly useful for:

- heavy volumes of bicyclists and/or other users;
- curves with restricted sight distance; and
- unlighted paths where nighttime riding is expected.

Where passing is permitted, a broken yellow line should be used. Broken lines should have a 1-to-3 segment-to-gap ratio. A nominal 3 ft (0.9 m) segment with a 9 ft (2.7 m) gap is recommended.

Figure 4-57: At left is a solid yellow centerline, used where passing would be inappropriate. At right is a broken yellow line, used where passing is permitted.

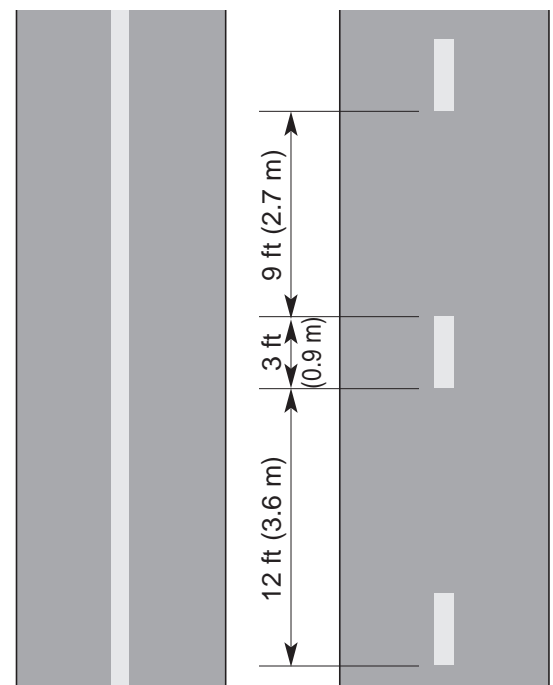

Figure 4-58: The centerline stripe should split to go around bollards.

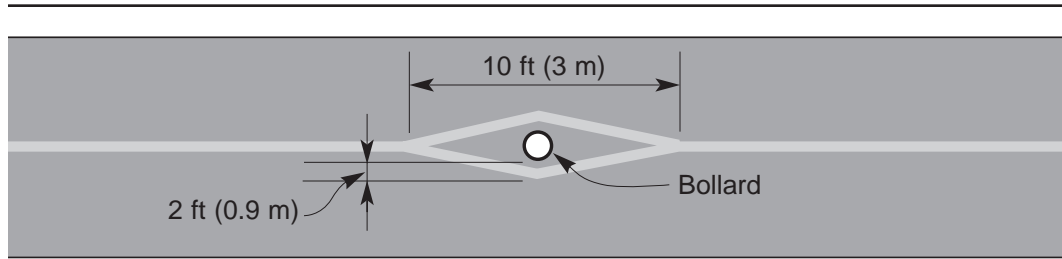

Figure 4-59: Sign used to separate path users by type.



R5-3

Figure 4-60 (right): One approach to separating bicyclists and pedestrians. Expect only modest success with treatments that do not physically separate bicyclists and pedestrians.



Figure 4-61: The “No Motor Vehicles” sign may be used at the entrance to a shared-use path.



R5-3

Excluding unwanted users: Typically, unauthorized motor vehicles are prohibited from shared-use paths. The No Motor Vehicles (R5-3) sign may be installed at the path entrance (fig. 4-61). Where other potential users are prohibited (e.g., horses, pedestrians, motor-driven cycles, etc.), appropriate combinations or groupings of these legends into a single sign may be used. These are described in Section 2B.31 of the MUTCD. Other means to discourage motor vehicles are discussed in Section 4.17.3.

Establishing right of way at intersections: Regulatory signs and markings are typically used to assign right of way at intersections, whether at path/path crossings or at path/roadway crossings.

Assigning right of way is done primarily through signage, the Stop sign (R1-1) being the most common. In addition, a Stop line pavement marking may be used to show where one should stop. While relatively uncommon in areas with substantial snowfall, a “Stop” word marking is also occasionally used. See also Section 4.15 on crossings.



Figure 4-62: The intersection of a path and roadway; in this instance, the path has the stop sign

Stop signs are used where those on one leg (or more) of an intersection are required to stop and yield to others. Yield signs (R1-2) are used at points where those on one leg (or more) of an intersection are required to yield the right-of-way to conflicting traffic — and where they have an adequate view as they approach the sign (fig. 4-63). Where they do not have an adequate view, Stop signs are generally used.

Figure 4-63: The “Stop” sign and “Yield” sign are used to assign right of way.



R1-1

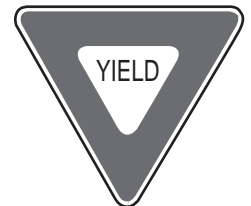

R1-2

When considering Stop sign placement, priority at a shared-use path/roadway intersection should be based on the following:

- *relative speeds of shared-use path and roadway users;*
- *relative volumes of shared-use path and roadway traffic;*
- *relative importance of shared-use path and roadway;*
- *if the path crosses the highway in a perpendicular fashion (mid-block style crossing) or crosses the legs of an intersection as a sidepath does.*

Speed should not be the sole factor used to determine priority, as it is sometimes appropriate to give priority to a high-volume shared-use path crossing a low-volume street, or to a regional shared-use path crossing a minor collector street.

When assigning priority, the least restrictive appropriate control should be placed on the lower priority approaches. Stop signs should not be used where Yield signs would be acceptable. Where conditions require bicyclists, but not drivers, to stop or yield, the Stop sign or Yield sign should be placed or shielded so that it is not readily visible to drivers.

Limiting speed: Some agencies have used speed limit signs and/or markings in an attempt to keep bicyclist speeds down. Since most bicycles don't have speedometers, however, there is some question about the effectiveness of such an approach. Instead, warning signs and pavement markings, as described in Section 4.14.2, may be more appropriate.



Figure 4-64: Warning signs let bicyclists know what to expect.

4.14.2 Warning devices

Warning devices are used to alert users to hazardous (or potentially hazardous) conditions on or adjacent to a shared-use path. They are also used to let others (e.g., motorists on a cross street) know about the presence of the path and the potential for conflicts (fig. 4-86). Warning devices require caution on the part of users and may require them to slow. If used, advance bicycle warning signs should be installed no less than 50 ft (15 m) in advance of the beginning of the condition.

Hazardous conditions: Warning signs and markings let path users know about problems like tight curves, low clearances, obstacles, and other hazards. Typically, these are permanent conditions that cannot be easily corrected. The signs below are examples of such devices.

Figure 4-65: Common hazard warning signs used on shared-use paths.



W1-5



W12-2



W5-4



W7-5

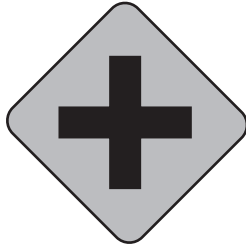

W2-1



W10-1



W11-1

Traffic controls and intersections: In advance of traffic controls and intersections, it may be helpful to place warning signs that alert users to the specific conditions (fig. 4-66). These are particularly applicable where the situation is not apparent (e.g., an intersection around a curve).

Figure 4-66: Typical warning signs related to crossings and traffic controls. The W2-1 and W10-1 signs would be used on the path, while the W11-1 would be used on a roadway to warn motorists of a path crossing.



Figure 4-67: Informational signs on paths often take on the character of the area or the path's namesake.

4.14.3 Informational devices

Information signs and markings are intended to simply and directly give users essential information that will help them on their way. They guide path users along paths; inform them of interesting routes; direct them to destinations; and identify nearby rivers, streams, parks, and historical sites.

Directional aids: Bicyclists often find it helpful to know where a path goes, how far certain destinations are, and if the section of a path has a route name or number. In general, names are preferred to numbers for routes because they are more descriptive and need less interpretation. For example, "Elroy-Sparta" (fig. 4-67) says more than "Route 23" (fig. 4-68).



M1-9

Figure 4-68: The "Numbered Route Sign" is used to connect routes between states.



D1-b(L)

Figure 4-69: A variety of destination and directional signs help to make paths more useful.



D1-b(R)

Signs that show destinations and distances are also helpful (fig. 4-69). These can help bicyclists decide if they have the time or energy to continue to a certain destination or whether they need to change their plans.



D1-1(c)

Similar signs that identify crossroads are also helpful, particularly along paths that follow their own rights-of-way. Without these, it may be difficult to tell where one is. A path following a river or creek, for example, may cross under many surface streets but from below, these streets may not be recognizable without a sign visible from the path.

Figure 4-70: An orientation sign that gives the user a sense of where he or she is.



At major trailheads, agencies may post larger signs with maps of the entire system or of the specific corridor (fig. 4-70). These help users orient themselves and identify landmarks like picnic areas, visitors' centers, and restrooms. Often, such signs also include path system rules and restrictions.

Another device often found on path systems is the distance marker (fig. 4-71). On highways, these take the form of "Reference Posts" found every mile, but on paths shorter increments are more appropriate. Markers every quarter or half mile may better suit the path environment and the casual users. Such markers are helpful for the user and maintenance worker, but may be critically important for police and others responding to an emergency.



Figure 4-71: Several designs for distance markers. These and other path enhancements can be designed to fit in rather than stand out.

Cultural markers: Markers may be used to identify special features (fig. 4-72). A path may follow a historically-significant abandoned railroad line or canal that once carried heavy traffic; or it may pass by an old town site or an important wildlife habitat. The markers typically describe the area and its significance and may include photos or other illustrations.



YES



YES

4.14.4 Temporary work zone controls

Agencies use temporary traffic control signs to help motorists get through or around a work zone. The same approach should be taken for shared-use path users (fig. 4-73, 4-74). Putting a barrier across a path without warnings and directional aids can create a hazard, particularly for bicyclists riding at dusk or at night. *[Bicycle lights are required in Wisconsin, but the law says lights only have to be seen from a distance of 500 ft.]*

Figure 4-72 (above): Sites with cultural or historical significance make interesting features of a shared-use path and should be identified for users.



YES

Each temporary traffic control zone is different. Many variables, (e.g., location, user speeds, lighting) affect the needs of each zone. The goal is safety with minimum disruption to users. The key factor in promoting temporary traffic control zone safety is proper judgment.

Figure 4-73 (top left): Just as temporary detours and road closure signs are used on roadways, similar attention should be paid to the needs of path users.

Since path speeds are much lower than highway speeds, however, the needs tend to be much simpler. In many cases, an advance warning sign on either end of a work zone with proper directional aids to a safe detour and, if necessary, lighting to illuminate any barriers or hazards will suffice. See the MUTCD for more detailed advice on traffic control zones, in general.

Figure 4-74 (lower left): Work zone safety is a part of every significant path reconstruction or repair project.



Figure 4-75: Warning signs offset from the path's edge for safety.

Figure 4-76: Clearances between the path and adjacent or overhead signs.

Figure 4-77: Where there is no alternative, a shield may be used to keep motorists from seeing a sign for path users.

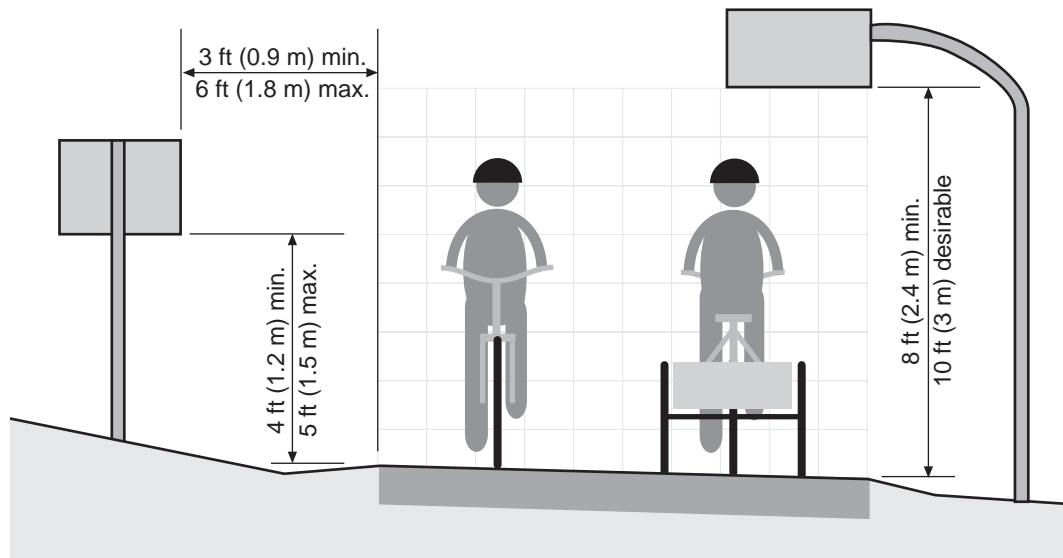

4.14.5 Placement of signs

Signs on shared-use paths should be placed where they are clearly visible to users but do not, themselves, pose a hazard (fig. 4-75). Signs must be at least 3 ft (0.9 m) but no more than 6 ft (1.8 m) from the near edge of the path. Mounting height for ground-mounted signs must be at least 4 ft (1.2 m) but no more than 5 ft (1.5 m), as measured from the bottom edge of the sign to the near edge of the path surface (fig. 4-76).

For overhead signs, the clearance from the bottom edge of the sign to the path surface directly under the sign must be at least 8 ft (2.4 m). *The clearance may need to be increased to allow typical maintenance vehicles to pass beneath.*



Signs for exclusive use of bicyclists should be located so that drivers are not confused by them. If necessary, shielding should be used to keep motorists from seeing them (fig. 4-77). If the sign applies to drivers and bicyclists, then it should be visible from both perspectives.

For more information on the use of signs and markings at intersections, see Section 4.15.



Figure 4-78: Shared-use path signs are smaller than their counterparts on roadways.

4.14.6 Sizes of signs

Shared-use path signs are smaller than similar signs used on various roadways (fig. 4-79). The appropriate sizes for path signs are given in the MUTCD (Table 9B-1). Signs in shared-use path sizes are not to be used where they would have any application to other vehicles. Larger size signs may be used on shared-use paths where appropriate.

4.14.7 Using restraint

Restraint in signing and marking shared-use paths is generally appreciated. Few path users want their off-road experience to exactly mirror the on-road environment. As an example, the use of warning signs at properly designed curves is generally unnecessary and intrusive. And such things as mile markers, path names, and historical markers can be designed to fit with the path's location or theme.

In areas where pavement markings are cost-effective, using them in conjunction with warning or regulatory signs at critical locations may be appropriate. Otherwise, theft of warning or regulatory signs may leave bicyclists unaware of serious hazards or their legal duties in a particular situation.

Care should be exercised in the choice of pavement marking materials. Some are slippery when wet and should be avoided. Product choice should consider skid-resistance, particularly at locations where bicyclists may be leaning, turning, or stopping.

This advice on signing and marking should be used in conjunction with the Manual on Uniform Traffic Control Devices (MUTCD).

Figure 4-79: Comparative sizes of stop signs.

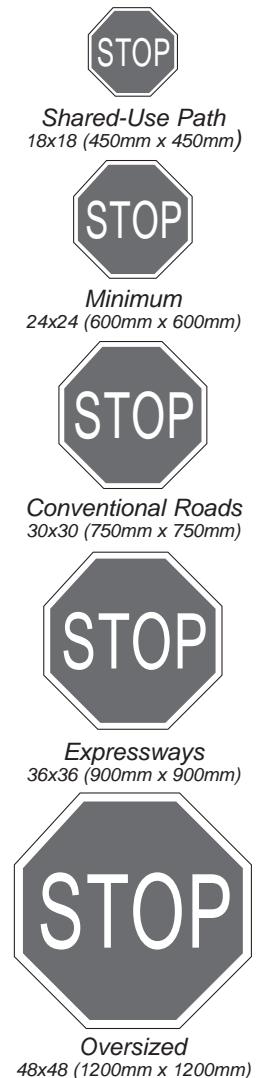

Figure 4-80: A challenging location to develop a crossing.



4.15 Path-Roadway Crossings

Roadway crossings can present some of the most difficult challenges in shared-use path design. Due to a wide variety of potential conflicts, optimal location and careful design are of paramount importance to the safety of path users and motorists alike. Historically, some designers have attempted to force bicyclists to stop, dismount, and walk across at crossings. However, experience has shown that such an approach seldom works. Ultimately, a good design is based on balancing the safety and convenience of all users in a fair and reasonable manner.

Fig. 4-81: A shared-use path follows a river corridor and takes full advantage of a grade separation with a freeway.



The crossing strategies discussed in this section should be considered basic guidelines, not absolutes. Each crossing is unique, with its own geometrics, traffic characteristics, and constraints. As a result, sound engineering judgment is a key ingredient to a successful solution.

4.15.1 Choosing crossing locations

Difficult crossing design problems can sometimes be avoided or simplified by paying careful attention to location. At a network planning scale, choosing a corridor with the fewest obvious conflicts can solve many problems. For instance, choosing to build on a rail-trail or within a river corridor (Fig. 4-81) can eliminate some

intersections entirely. Conversely, placing a path along an urban street will introduce path users to many side-street intersection and driveway conflict points.

At the project level, path alignment may be shifted to avoid a hazardous location (e.g., a blind highway curve or busy intersection). Figure 4-82 shows an example with two possible alignments, one with a serious sight obstruction.

Path intersections and approaches should be on relatively flat grades. A steep incline with a stop sign at the bottom will make it difficult for less experienced bicyclists to stop in time. And such an incline will increase the path's design speed and the stopping sight distance.

Unwary bicyclists may not begin slowing down soon enough to safely come to a stop (fig. 4-83). They may brake too hard and crash or ride into the intersection without being able to stop, particularly in wet or icy conditions. If such conditions cannot be avoided, advance warning signs and increased stopping sight distances should be provided.

For these reasons, providing an appropriate length of level path before the intersection will allow bicyclists to slow down. See Section 4.9. for a discussion of path runout distances at the bottom of grades.

4.15.2 Intersection: yes or no?

When deciding how to handle a path/roadway crossing, the first step is an obvious one: determine whether an intersection or a grade separation is the answer. On the one hand, choosing an intersection approach involves addressing how bicyclists and motorists will interact at the crossing — who must yield to whom; whether there are sufficient gaps in roadway traffic; what roadway and traffic control changes may be required; and so on.

On the other hand, choosing a grade separation eliminates the intersection entirely, as mentioned in the previous section. It may, however, require designers to find an accessible site that will accommodate the ramps and structure.

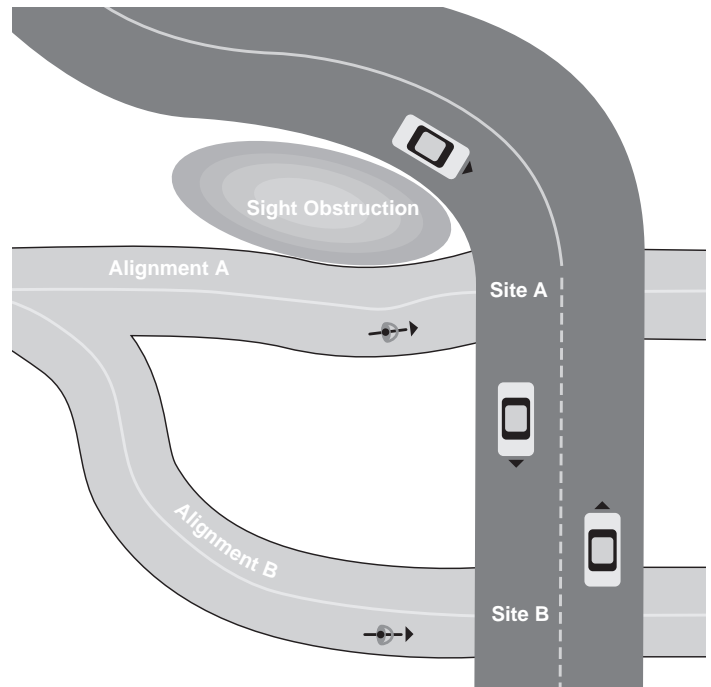

Figure 4-82: Proper path alignment can help eliminate sight obstructions. Alignment “B,” for example, gives a better crossing location than does alignment “A.”

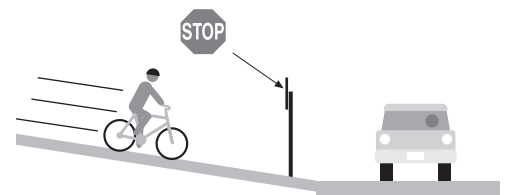

Figure 4-83: Path roadway intersections should not be placed at the bottom of a grade.

Figure 4-84: A grade separation is the only option for getting path users across a controlled-access freeway.



If the roadway to be crossed is a controlled-access freeway, there is no decision to be made; the crossing must be grade separated. The questions remaining involve where to put the grade separation, whether to go over or under, and whether it can safely be combined with a surface street crossing (see Section 4.15.17).

At the other end of the spectrum, crossing a quiet residential street (fig. 4-85) or low-traffic rural road (fig. 4-86) would almost never warrant a grade separation. The only situation where one would likely make sense would be if the path corridor was already lower or higher than the street or there were significant sight limitations at the intersection. Examples include below-grade railroad right-of-ways or waterways.

Figure 4-85: A low-volume residential street crossing needs very little special attention.



4.15.3 Rural vs. urban/suburban locations

Between the extremes, the decision to create a path/roadway intersection or a grade separation first involves whether the crossing is rural or urban/suburban in character. Typical differences include traffic speeds, path and roadway volumes, roadway geometrics, surrounding development, and likely path users.



Figure 4-86: A shared-use path crosses a rural low-volume highway. Signing and marking, combined with good sight distance, are the primary requirements.

4.15.3.1 Rural path crossings

Rural paths typically cross high-speed roadways with a wide range of traffic volumes. Where volumes are low, crossing distances are moderate, and sight distances are good, little is required beyond basic signing and marking (fig. 4-86). In some cases, the crossing location may need to be shifted to improve sight distance (see Section 4.15.1).

Crossing moderate-volume rural highways, on the other hand, may require more extensive provisions, depending on the path's proximity to a community or recreational area and likely level of use. In some cases, a combination of signs, pavement markings, and a median refuge may be adequate. The refuge (see Section 4.15.4.2) allows bicyclists to cross half of the roadway at a time (fig. 4-87). Traffic signals, however, are seldom appropriate for rural path crossings, due to relatively low path volumes and high highway speeds.



Figure 4-87: A path crossing at a moderate volume highway combines a raised median refuge with signing and marking.

Figure 4-88: A grade separation takes bicyclists under a moderately busy highway. Sightlines are good and the entry and exit grades are slight.



Rural grade separations: In some cases, a grade separated crossing is the best option for rural highways, keeping path users completely away from the highway environment (fig. 4-88). If provided, care must be taken to assure that the grade separations, themselves, are designed for the safety of the path and highway user; structures, for instance, must meet applicable highway clear zone requirements.

Typical examples of grade separation options include:

- *taking advantage of railroad rights-of-way (fig. 4-67) or river corridors that provide “natural” grade separations;*
- *shifting path alignment to an existing grade separated roadway crossing.* For example, if a minor road goes over or under the highway, it may provide a safe option (see Section 4.13.3 for cautions about mixing path traffic and roadway traffic);
- *providing a properly-sized box culvert for the path.* This can be a relatively economical option if ramps with proper slopes can be provided and adequate clearances for path users and maintenance vehicles are maintained (fig. 4-37); and
- *providing an overpass or underpass bridge structure.* These may be expensive and should be used where most needed. In some cases, grade separations may be provided as part of a highway improvement project.

Determining whether a rural grade separation is needed involves looking closely at the characteristics of the crossing location. The Wisconsin Department of Transportation has developed a process for analyzing traffic volumes and speeds to determine which rural crossings need grade separations and is included in FDM 11-55-15. The approach involves first determining if the roadway meets basic thresholds for consideration:

Minimum requirements for rural grade separation:

- *The minimum highway Annual Average Daily Traffic (AADT) should be 3500 or greater.* This threshold is a starting point, but does not preclude looking at highways with less than 3500, should it be necessary.
- *Rural posted speed limits should be between 40 and 55 mph.*

If these warrants are met, the designer then conducts hourly path and roadway traffic counts (projected path counts may be used if necessary). From these, a gap analysis, similar to that described in the MUTCD’s warrants for traffic signals, is prepared. An “exposure factor” is derived by multiplying the hourly volumes for path traffic by the roadway traffic volume for the same hour.

Exposure factor: *Path Hourly Traffic Volume X Roadway Hourly Volume (for same hour)*

The highest and fourth highest exposure factors are then used to determine the necessity of a grade separation:

Table 4-10 Path-Highway Crossing Guidance for Rural 2-lane Highway Facilities
Grade Separation Alternatives

<i>Hourly Exposure Factor (in 1000s)</i>	<i>Does Not Meet WisDOT Warrants</i>	<i>May Be Justified</i>	<i>Meets WisDOT Warrants</i>
<i>4th Highest Exposure Factor</i>	<i><25</i>	<i>25-35</i>	<i>>35</i>
<i>Highest Exposure Factor</i>	<i><40</i>	<i>40-60</i>	<i>>60</i>

Note At-grade trail crossings are undesirable on multi-lane rural expressways. Evaluate these locations on a case by case basis.

For a copy of the Wisconsin DOT guidance, see “Permanent Public Trails Crossing Rural Roads in FDM 11-55-15.



Figure 4-89: Urban and suburban paths often need to cross arterial and collector streets.

4.15.3.2 Urban/suburban path crossings

In more developed areas, crossing designers must consider a wide variety of constraints. More so than is often true on rural paths, urban and suburban path crossings require designers to balance numerous competing needs and constraints while providing a facility that is safe and convenient.

Common urban/suburban path crossing constraints and challenges:

- *There is often little potential path right-of-way in built-up areas; as a result, options for developing good crossings may also be limited.*
- *Roadways are often wider and may have numerous intersections and dedicated turn lanes (fig. 4-90).*
- *More of the urban and suburban streets may carry substantial levels of traffic than rural roads.*
- *Nearby shopping areas may have numerous busy commercial driveways intersecting the roadway.*
- *Path right-of-way may pass between buildings or other structures and, as a result, present no possibilities of shifting one way or another.*



At the same time, urban and suburban path crossings may present opportunities not available in most rural areas.

Common path crossing opportunities:

- *With the exception of urban freeways, expressways, and some major suburban arterial streets, traffic speeds are significantly lower than on rural roads and highways.*
- *A crossing may be coupled with a nearby signalized intersection to provide an easier way across a major arterial street.*
- *Redevelopment may open up new corridors.*
- *An adjacent landowner (e.g., a university) may help fund an expensive crossing.*
- *The proximity of larger numbers of potential users may make an expensive path crossing easier to justify than a similar crossing on a lightly-traveled rural path.*

Figure 4-90: Existing grade differences made it relatively easy to carry this rail-trail above a major suburban arterial street.

The Wisconsin Department of Transportation has not, at this time, developed a warrant process for judging the necessity of urban or suburban grade separations. The complexities of many crossings make it difficult to develop a comprehensive set of warrants. At the same time, an analysis of traffic volumes, similar to that used for rural crossings, would be useful in understanding the challenges presented by a crossing opportunity. If gaps in cross traffic are frequent, developing a grade-level crossing would likely be feasible. If they are rare and providing a signalized crossing is not possible, a grade separation may be the only way to go.

The following options cover the range of likely urban or suburban crossing situations and the general character of the solutions:

- *crossing low-volume streets* requires little more than basic improvements – stop or yield signs, warning signs, and pavement markings;
- *crossing medium-volume streets* may combine signs and markings with median refuges;
- *crossing high-volume streets* may require a signalized intersection and/or a median refuge; and
- *crossing very-high volume streets* will likely require a grade separation; freeways do require one.

These points may perhaps be better understood in the form of a graphic. Figure 4-91 summarizes some of the factors to consider in the decision.

Figure 4-91: As the complexity of a path/roadway crossing situation increases, the crossing design must change also.

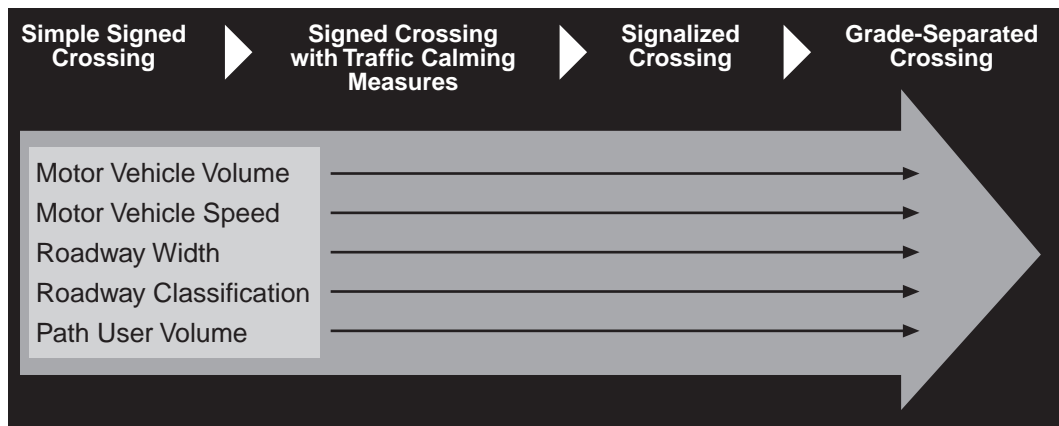

Figure 4-92: A well-designed combination path and street crossing requires doing more than adding push buttons.

4.15.4 Crossing design

In this section, each crossing situation is described in greater detail in order to facilitate the design process. While the following discussion covers the primary points of interest, additional guidance is available. The report *Trail Intersection Design Handbook* (Florida DOT, 1996) has additional information to help the crossing designer.



Combining path and street crossings

If the path is close to an existing roadway intersection, a combined path/roadway crossing may be necessary — and may work well if conflicts with turning traffic can be minimized (see Section 4.15.5). If this is not possible, the path alignment may need to be reconsidered or the intersection reconfigured.



Figure 4-93: A basic signed crossing includes traffic controls, warning devices (signs and markings), and good sight distance.

4.15.4.1 Simple signed crossing

A simple signed crossing is most appropriate on low-volume residential streets (fig. 4-93) or quiet rural town roads (fig. 4-94). It typically includes the following elements:

- Traffic controls for either path or road traffic, depending on which should have priority (see Section 4.14.1);
- Adequate sight distance (based on traffic speeds); and
- Warning devices to alert path and roadway users.



Figure 4-94: This rural crossing has excellent sight distance for both motorists and bicyclists. Signing and marking make it clear what to expect.

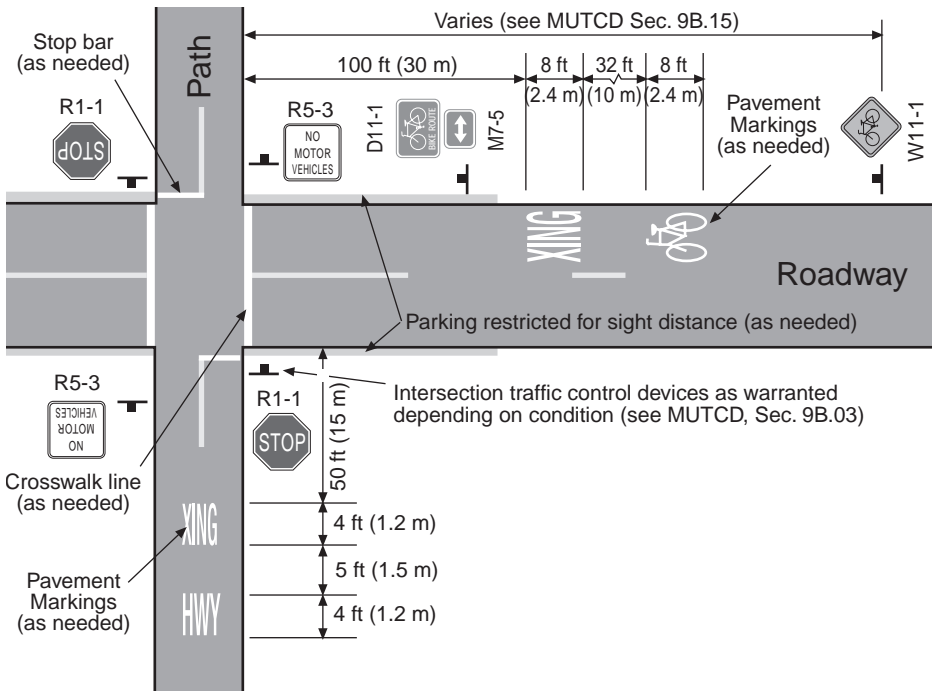
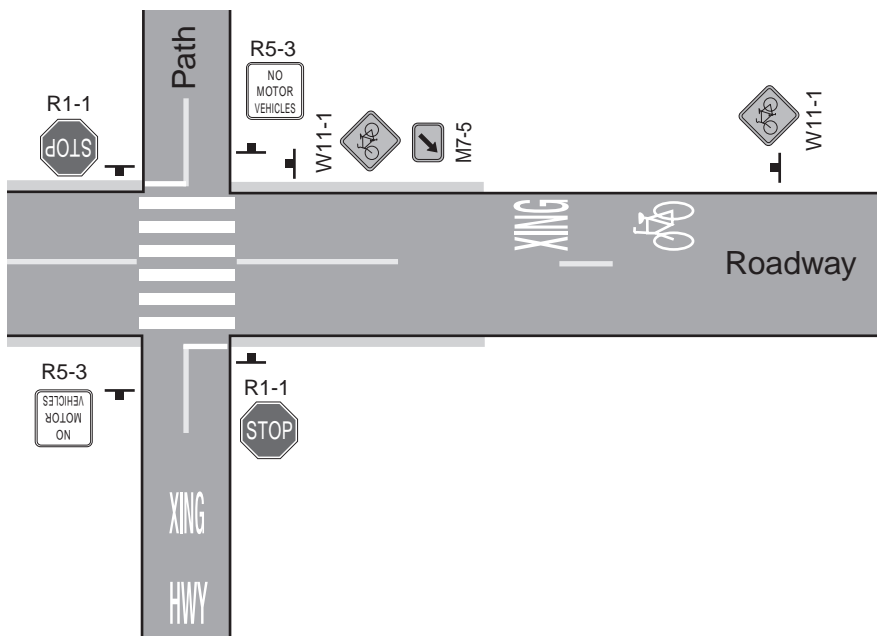

Figure 4-95: Typical signs and markings for path crossings (after Fig. 9B-3, MUTCD, 2000)

On crossings of neighborhood collector streets and minor county trunk highways, a higher level of attention may be needed. In addition to the regulatory and warning devices shown in Figure 4-95, crosswalk stripes may be increased in width to as much as 24 in (0.6m).

Figure 4-96: Extra emphasis may be needed at some crossings.

Alternative crosswalk patterns, such as diagonal or longitudinal striping (fig. 4-96), may also be used (see MUTCD, Sec. 3B.17), as may two sets of W11-1 Bicycle Crossing warning signs: one at the crossing with a diagonal arrow subplate (W16-7) and the other in advance of the crossing. Crossing signs may also use a fluorescent yellow-green background.



For intersections with quiet, low-speed streets (≤ 25 mph), one option may be to create a raised crossing (fig. 4-97) or speed table. See Section 2.10.2 for more information on speed tables.



Figure 4-97: A raised path crossing used to slow motorists and give path users priority.



Figure 4-98: An at-grade path crossing of a low-volume rural roadway. Note damage to bollard; see Section 4.17.3 for alternative approaches to discouraging motor vehicle intrusion.



Figure 4-99: Traffic calming measures can make a significant difference in how easily path users can get across a roadway.

4.15.4.2 Signed crossings with traffic calming measures

Traffic calming measures can help path users cross minor or major arterial streets (fig. 4-99), county trunk highways, or multi-lane roadways. Such measures can help slow traffic or reduce the crossing distance. In addition to elements mentioned previously, one or more of the following may be appropriate:

- Median refuges (fig. 4-100) between opposing directions of roadway traffic; and
- Curb bulbs extending into the roadway reduce crossing distance (applicable where an on-street parking lane is provided);

Figure 4-100: Features like curb bulbs and/or median refuges are among the traffic calming measures that can be applied to a path crossing.

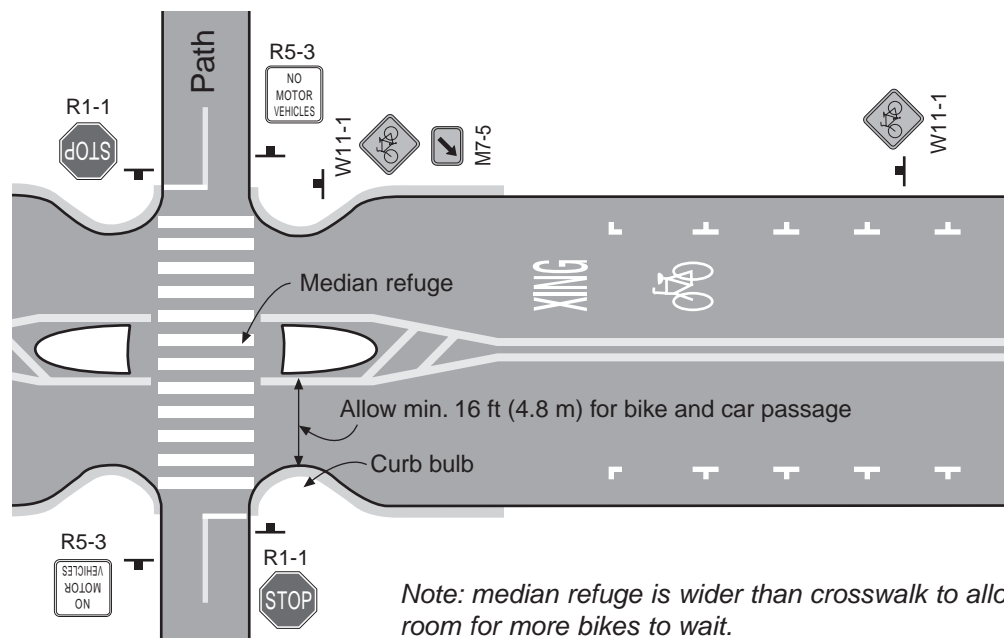

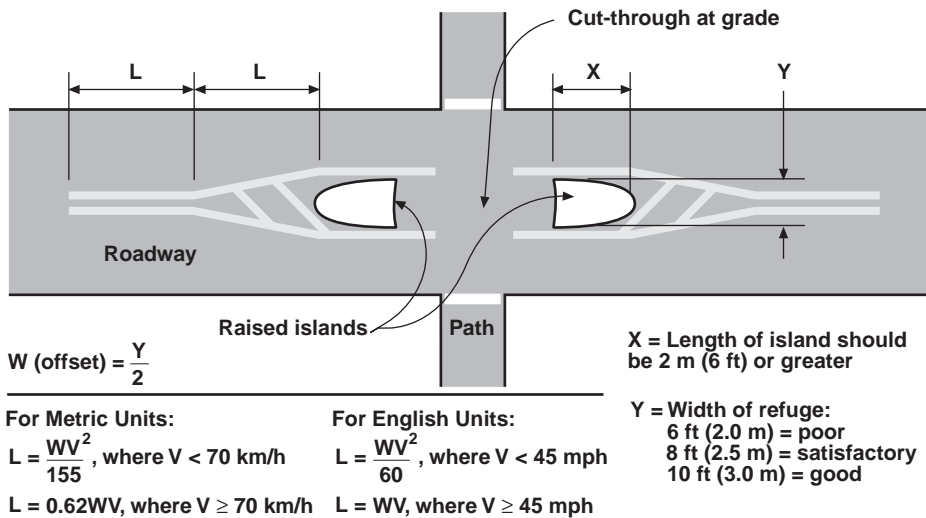

Figure 4-101: Basic elements of a median refuge. (After Fig. 23, *Guide for the Development of Bicycle Facilities*, AASHTO, 1999; and fig. 22, *Trail Intersection Design Handbook*, FLDOT, 1996.)

Median Refuges: Generally, it is easier for path users to cross one half of a busy road at a time. As a result, median refuges can reduce path user delays and clearance intervals. And, they give users a place to wait in relative safety until motor vehicle traffic clears. Raised medians are preferred over paint-delineated areas; the latter may be used by some motorists as storage areas for left turns.

Refuges may be cut through the island (fig. 4-101) or may include curb ramps to take users up to the island level. The former is more advantageous, since the entire width is available for users waiting to cross. Curb ramps, on the other hand, can significantly reduce the level waiting area, a limitation of particular concern to bicyclists and wheelchair users.

Curb bulbs: Curb bulbs, or extensions reduce crossing distances for path users, thus reducing the time they are exposed on the roadway. With 8 ft (2.5m) extensions on each side, for example, crossing time for pedestrians may be reduced by 3 to 5 seconds, depending on walking speed.

Bulbs also visually and physically narrow the roadway, encouraging motorists to drive more slowly. And curb bulbs can prevent motorists from parking in — or too close to — the crossing.

Curb bulbs should only be used where there is an on-street parking lane and should extend into the roadway no more than the width of the parking lane. They must not extend into travel lanes, bicycle lanes, or shoulders.



Figure 4-102: Some path users need extra time to cross a roadway. Curb bulbs and median refuges help them, in particular.



Figure 4-103: An independent signalized crossing for a suburban path. (Note dark, marginally-reflectORIZED bollards — a hazard, particularly under low light conditions.)

4.15.4.3 Signalized crossings

A signalized crossing may be necessary where a path crosses a major arterial street or a suburban highway. While there are currently no warrants for path crossing signals, the report *Trail Intersection Design Handbook* (Florida DOT, 1996) notes the following:

Traffic signals are appropriate under certain circumstances, with warrants for installation as discussed in the MUTCD. Though none of the 11 warrants specifically address trail crossings, they could be used since the bicycle is considered a vehicle, and trails could be functionally classified...

The signal actuation mechanism (fig. 4-104) should be mounted beside the trail 4 ft (1.2 m) above the ground and easily accessible. This enables the bicyclist to activate the signal without dismounting. Another method of activating the signal is to provide a detector loop in the trail pavement, though this works only for bicyclists.

On signalized roadways with a median refuge, a push button should also be provided at the median in order to serve slower path users who may otherwise be trapped in the middle of the road. Some situations may warrant flashing yellow warning lights after an engineering analysis and appropriate permitting by state and local authorities.

At some crossing locations, where optimum progression is not a factor, the designer may consider giving the path user a “hot response” or immediate call, to encourage bicyclists with the shortest possible wait. This feature will likely increase the number of path users that wait for the signal.



Figure 4-104: Path users need a way to trip the signal. If a loop detector is used for bicyclists, a push button for pedestrians should also be provided. Alternative means of detection (e.g., infrared) have been used for such purposes.

Where paths cross multi-lane roadways, visibility between the path user and the motorist in the far lane (fig. 4-105) can be blocked. For this reason, stop lines should be placed in advance of the crosswalk, the distance being based on traffic speeds. *Note: on this topic, Section 3B.16 of the MUTCD, says that “Stop lines at midblock signalized locations should be placed at least 40 ft (12 m) in advance of the nearest signal indication.”*

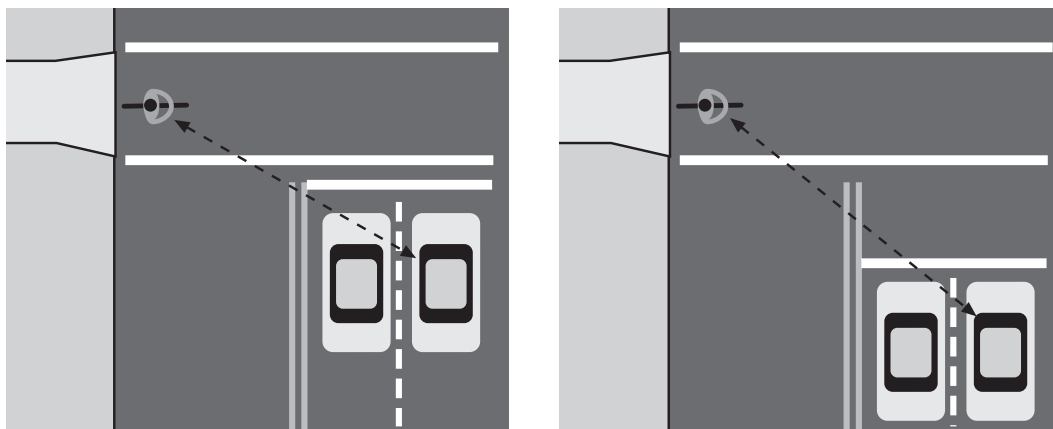
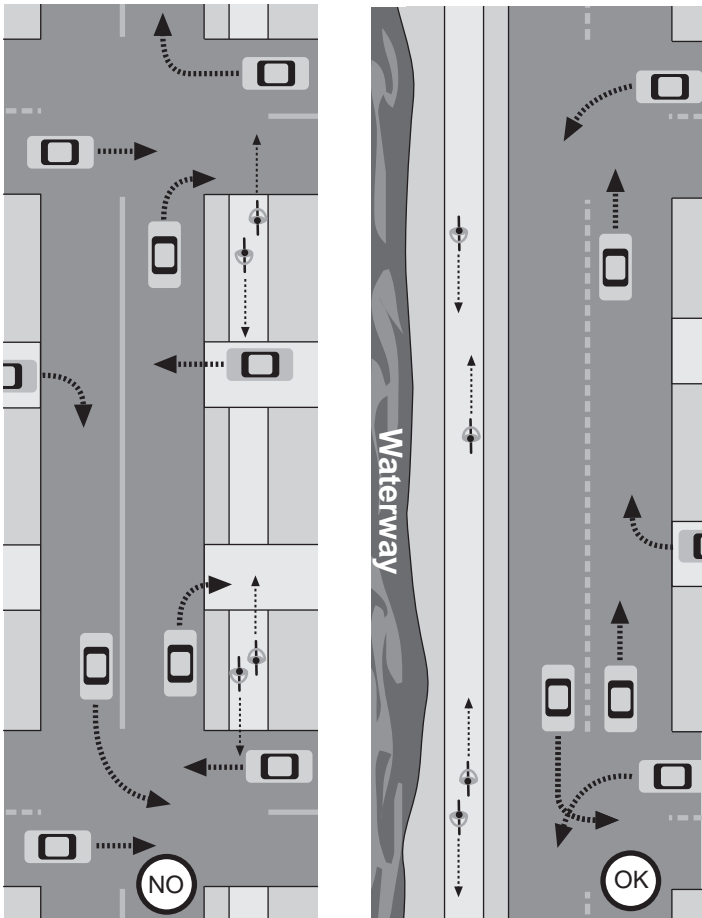

Figure 4-105: Off-setting the stop line away from the crossing will improve visibility between motorists and path users. (After figs. 29, 30, Trail Intersection Design Handbook, FLDOT, 1996.)

Figure 4-106: An urban crossing that takes advantage of an adjacent signalized intersection. A bicycle signal loop detects bikes to change the signal. Note high-visibility crosswalk marking.



Figure 107: (below left) A path with many crossings increases conflicts; (below right) a path with few crossings reduces conflicts.



4.15.5 Parallel Path Crossings

A parallel path is one that is adjacent to a roadway. Because of this relationship, the path typically intersects most of the same streets and driveways that the road, itself, does (fig. 4-107 and see Section 4.3 for more information).

An important exception occurs where cross streets form a “T” intersection and stop short of the path, as where the path follows the shore of a river or lake (fig. 4-106, right). This situation, with its somewhat limited crossing conflicts, is a characteristic of the most desirable parallel path locations.

As a general rule, the more often a parallel path crosses intersecting streets and driveways, the greater the likelihood of crossing conflicts between bicyclists. Similarly, the more traffic that enters or leaves the cross streets or driveways, the worse the situation.

Note: Some agencies have attempted to solve this problem by placing Stop signs for bicyclists at every intersection, even if the parallel roadway has priority over crossroads.. This approach damages the path's utility and encourages a "scoff-law" attitude among those riding it.

Further, Wisconsin State Statute 346.803(b) requires bicyclists to "obey each traffic signal or sign facing a roadway which runs parallel and adjacent to the bicycle way." As a result, stop or yield conditions for bicyclists on parallel sidepaths should generally be consistent with the traffic controls imposed upon traffic of the adjacent roadway.

Where the path crosses intersecting roads (and, to a lesser extent, driveways), the potential conflicts facing path users (fig. 4-108) primarily come from drivers turning left (A) and right (B) from the parallel roadway, and entering from the crossed roadway (C, D, E). In addition, path users can be coming from either direction (F, G) on two-way paths.

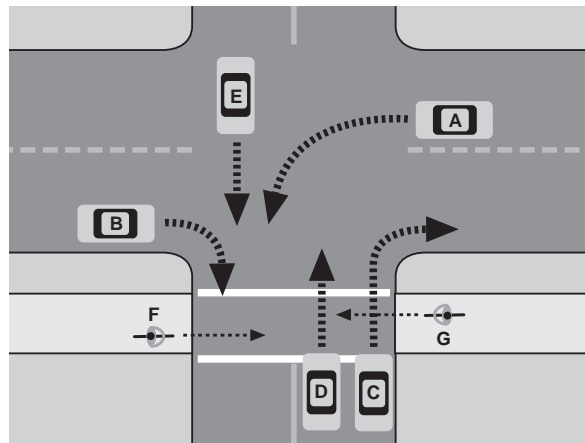

Figure 4-108: Possible conflicting turning and crossing movements that should be accounted for in an adjacent path crossing.

To some extent, the severity of these conflicts may be affected by how close the path is to the roadway it parallels. Generally, it is preferable if the path crosses the intersection relatively close to that road it parallels (fig. 4-105) unless the crossing may be located far enough away to minimize the intersection's impacts altogether. A location in between makes it harder for the path to take advantage of the intersection's traffic controls and makes it impossible to develop an independent crossing.

Consider the information in Table 4-11, based on information presented in the Florida DOT *Trail Intersection Design Handbook*, Table 3:

Table 4-11: Effects of path-roadway separation distance			
<i>Parameter</i>	<i><3.3 - 6.6 ft</i>	<i>13.2 - 33.3 ft</i>	<i>>99 ft</i>
M. V. turning speed	(1-2 m)	(4-10 m)	(30 m)
M.V. stacking space	Lowest	Higher	Highest
Driver awareness of path user	None	Yes	Yes
Path user awareness of M.V.'s	Higher	Lower	High or low
Chance of path right-of-way priority	Higher	Lower	Highest
	Higher	Lower	Lowest

Figure 4-109: This path has few crossings and good visibility at this intersection. Even so, it is important to reduce conflicts between turning and crossing movements. A separate left turn phase for the bus, for example, could help.



4.15.5.1 Signalized parallel crossings

If the intersection in question is signalized, some basic modifications may be needed to reduce the hazards posed for path users. Simply introducing path traffic into an existing intersection without such modifications can lead to serious safety problems.

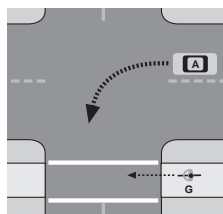

Left-turning traffic: For motorists turning left across the path (A), the primary danger is that they will not look for (or see) path users before making their turn. Prohibiting permissive left turns may be appropriate. A protected turn phase (with accompanying Don't Walk signal for path users) may be the best solution.

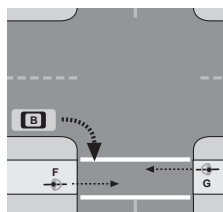

Right-turning traffic: For motorists turning right from the parallel roadway (B), the concerns are that they will fail to see and yield to path traffic. Reducing turning speeds or providing a “speed table” at free right turn lanes or making the corner turning radius as small as practical may be necessary to reduce conflicts.

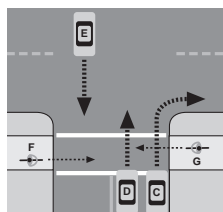

Side street traffic: For motorists pulling forward into the path crossing from the side street (C and D), the main concern is that they will do so without yielding or may wait in a position that blocks path traffic. Prohibiting right-turns-on-red and placing a stop bar in advance of the path crossing may help solve the problem. For motorists crossing from the far side (E), an adequate clearance interval should be provided for their green before the path’s Walk signal .



Figure 4-110: Positive features of this crossing are good visibility and proximity to the roadway intersection. Problems include lack of crosswalk marking and confusing right-of-way assignment (bicyclists apparently required to yield to motorists who have a stop sign).



Figure 4-111: Some elements that would help include highlighting the crossing, moving the stop sign and stop bar for the crossroad, as well as adding appropriate warning signs (not shown). Still, motorists will tend to stop in the crosswalk to wait for traffic and the design is far from optimal.

4.15.5.2 Signed parallel crossings

Signed crossings provide additional challenges because certain movements may not be easily controlled (fig. 4-110). The primary principle to keep in mind is that the path should have the same priority as the parallel roadway (fig. 4-111). Some strategies mentioned in the previous section will be useful. However, the following additional points should be noted.

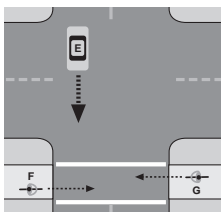

Far side crossing traffic: For motorists crossing from the far side (E), the primary danger is that they will not pay attention to path users. Path crossings should be as visible as possible with good sight distances on either approach. Raised crossings may be necessary to assert path priority where appropriate.

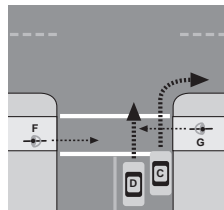

Nearside crossing traffic: For these motorists (C and D), the primary problem involves encroaching on and blocking the path crossing while waiting for a gap in traffic. As shown in figures 4-110 and 4-111, stop signs and stop lines for such traffic should be placed before the crosswalk, the crossing should be highlighted, and sight lines should allow motorists to see cross traffic from behind the crosswalk. Raised crossings may be necessary.

4.15.6 Important features of all crossings

The challenges — and opportunities — presented by a path/roadway intersection design can be complex and each solution is likely to be unique due to its combination of factors. But a well-done crossing can significantly enhance the path's utility and appreciation among users. In summary, for the safety and convenience of path users and roadway users, all path crossings should include the following features.

Figure 4-112:
Warning devices
let motorists know
there is a path
crossing.



Limited number of crossings: The more intersections a path has, the more frequently path users will have to deal with crossing traffic. It is important to limit the number of crossings and this may require a sober assessment of a potential path's suggested corridor or alignment.

Right angle crossings: Paths should meet roadways at right angles, rather than crossing at a skew. In this way, path users can easily see motor vehicle drivers and vice versa. In some cases (For example, where an old railroad right-of-way crosses a road at 45 degrees), a curve may need to be introduced to the path's approach alignment in order to create an appropriate crossing angle.

Crossing complexity: Path/roadway crossings should be designed to minimize complexity. Path users can be of virtually any age and, as a result, the simpler the crossing the better. For example, some parallel crossings require users to figure out which roadway traffic lanes get the green light, and when, in order to determine if it is safe to cross. And some crossings require motorists to guess whether they should stop for path users or cross. The level of difficulty of the path user's and road user's respective tasks must be a key factor in the design process.

Crosswalk visibility (fig. 4-112): Increasing crossing visibility with, for instance, enhanced crosswalk markings (fig. 4-96) can help all of these problems but, as mentioned elsewhere, the marking materials should not be slippery. Some communities have had success following the European example, providing colored crosswalk materials. This is not a standard treatment and must be done with special permission.

Crossing approach grade: Crossing approaches should be relatively flat in order to make stopping easier for bicyclists. Downgrades leading to a crossing in particular should be avoided. Braking to a controlled stop on grades can be especially challenging for casual bicyclists and children.

Good sight distances: Corner sight triangles must be kept clear of obstacles that might block the view between road users and path users. Bushes, signal controller boxes, light standards, and street furniture should not be allowed to interfere with this important requirement.

Clear right-of-way assignment: Confusion can easily lead to mistakes. And mistakes can lead to crashes. By making it clear who is required to yield at a crossing, designers can reduce that confusion, improve safety, and enhance a path's utility and comfort.

Ramp width and smoothness: Where the path enters the roadway, the curb ramp must be at least as wide as the path and should flare to the outside at the roadway interface. In addition, the transition must be smooth. A steep gutter pan that abruptly reverses slope or one with a lip will hamper wheelchair users and may trap them, unable to go one direction or the other. It will also cause some wheelchair users or bicyclists to stop or slow in the roadway as they negotiate the bump, resulting in increased roadway exposure.

Street lighting: Crossings should be well-lit so that path users can see approaching roadway traffic and, more importantly, so that roadway traffic can see path users. Pedestrians and wheelchair users are not required to use reflective material or lights; and bicyclists' lights may not provide adequate side visibility. See Section 4.13 for more on path lighting.

Figure 4-113: Near riverfronts, it is often possible for a “natural” grade separation to occur where roadways pass overhead. Adequate clearance must still be allowed for path users and maintenance vehicles.



4.15.7 Grade separations

A grade separation may be the answer if none of the at-grade intersection approaches will work — or if a path is particularly busy. Overpasses and underpasses each have their strengths and weaknesses (Table 4-12). And choosing one over the other requires balancing important factors.

One is the required grade change (up or down). The greater the elevation change, the longer the ramps must be (fig. 4-114) if they are to be kept to a proper slope (see Section 4.8). And to accommodate long ramps, more land must be found or structures must be built with switchbacks or a squared-off spiral design to gain or lose the required height. These issues may determine whether an overpass or underpass is feasible.

Figure 4-114: Overpass approach ramps are typically longer than ramps for underpasses and can significantly increase costs.



In addition, connections with the surrounding road network should be convenient and safe. While a grade separation may isolate path users from the immediate vicinity, many will want access to nearby land uses (e.g., restaurants, shops, schools) and nearby residents will want access to the path. To this end, connector paths must be carefully planned. Junctions must minimize hazards of introducing path users into the traffic environment. In some cases, paths may connect with low-volume residential streets.



For design information on grade separations, see the discussion on structures in Section 4.16.

Figure 4-115: A dark, damp, and uninviting underpass. In addition, the path entrance should be flared out to eliminate the path-side hazards.

Table 4-12: Overpass and underpass considerations

Overpasses

Positive:

- *Good visibility from surrounding area*
- *Light during the day*
- *Open and airy*

Negative:

- *Typically requires greater elevation change than underpass*
- *Bicyclists use energy to go up, gain it back coming down*
- *Open to the elements*
- *Vandals may drop or throw things onto road*
- *Some users may feel vertigo*
- *Bicyclists attain higher freewheeling speeds making ramps more difficult to negotiate and design*

Underpasses

Positive:

- *Protected from weather*
- *Bicyclists gain energy going down, lose it going up*
- *Change in elevation is likely to be less than with overpass*

Negative:

- *Can be dark, damp, and intimidating (fig. 4-115)*
- *Users may not be able to see through to other side*
- *Some users may feel claustrophobic*
- *Criminals may hide, waiting for path users*



Figure 4-116: A popular multi-use path structure connecting a university campus and nearby residential areas.

4.16 Shared-use path structures

Structures — overpasses, bridges, tunnels, and underpasses — can play critically important roles in shared-use path systems. While typically expensive, they can provide the linkages that tie a path network together. And since structures will likely to last for years, they should be built to serve future needs. Saving money by using inadequate bridge widths, for example, may provide a short-term cost savings but may mean the structure will quickly become obsolete.

Figure 4-117: An open and airy underpass. Note the generous clearances on either side.



Structures can reduce travel time by providing short cuts between destinations. Often, a path network that includes structures at key locations can give users a competitive advantage over motorists traveling to the same destinations. And, as mentioned in Section 4.15.2, structures can provide users with a safe way across major traffic corridors.

4.16.1 Bridges and overpasses

The following considerations apply to shared-use path bridges and overpasses:

Basic width: On new bridges or overpasses, the minimum clear width should be 12 ft (3.6 m), the desirable width is 14 ft (4.25 m). A bridge 12 ft wide provides for the basic path width of 10 ft (3 m) plus a 1 ft (0.3 m) clear zone on either side (fig. 4-118). Approach ramps should be as wide as the approaching path and the path's shoulder width should taper as necessary to match the bridge width.

Using such clearances in designing a structure serves two primary purposes:

- it provides a minimum shy distance from the railing or barrier; and
- it provides maneuvering space to avoid conflicts with pedestrians and other bicyclists stopped on the bridge.

Note: The widths of common emergency, patrol, and maintenance vehicles should also be considered in establishing the widths of structures. If there is no other way for such vehicles to reach the other side or if the alternative route is much longer, these vehicle's widths should govern; for instance the WisDOT bridge inspection vehicle needs a minimum path width of 10 ft (3 m), preferably more, for it to properly use its boom to inspect the sides, supports, and undersides of the bridge.

In some cases, providing a wider structure than suggested above can be justified. For example, a bridge that connects a college campus with a nearby residential area (fig. 4-116) may attract high volumes of users. Or the structure may provide an important entryway to the system. In some cases, a bridge may be widened in the middle to provide an overlook. This approach gives those who wish to enjoy the view a place to stand out of the traffic flow. And it may substitute for widening the entire bridge if volumes are not expected to be too high.

Figure 4-118: Bridge and overpass widths are measured between the railings.

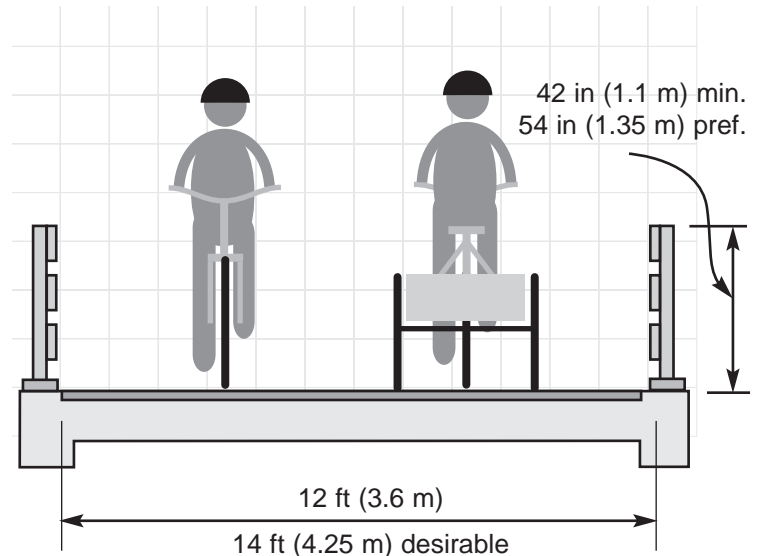
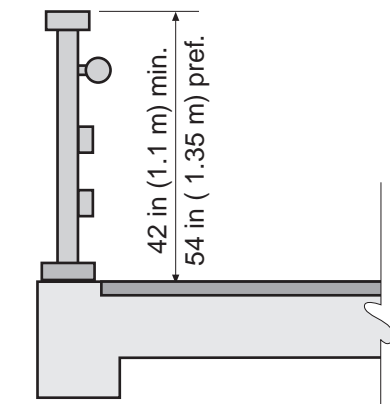



Figure 4-119: This bridge's width was limited by openings in the supports for the transit bridge above. It was further narrowed by angling railings inward.

Figure 4-120: Railings should be high enough to prevent pitchover.

Physical constraints may preclude providing adequate bridge width (e.g., a bridge may need to fit between existing supports as in fig. 4-119). In such cases, it may be necessary to provide a substandard bridge width but mitigation measures should be taken to minimize the hazard. Warning signs, extra sight distance at ends, and other elements may help.



Bridge railings: Railings, fences or barriers on both sides of a bridge or overpass are recommended to be 54 inches. This is especially important on highly elevated structures, high use facilities (particularly high-mixed use), or on long bridges. Railings, fences, or barriers shall be a minimum of 42 inches. There is a minor exception to this for an inside barrier when a path shares a bridge with a roadway. See FDM 11-35-1. Also, hand rails may be mounted 30 to 34 inches (0.75 - 0.8 m) above the deck.

Bridge railings: Railings, fences or barriers on both sides of a bridge or overpass are recommended to be 54 inches. This is especially important on highly elevated structures, high use facilities (particularly high-mixed use), or on long bridges. Railings, fences, or barriers shall be a minimum of 42 inches. There is a minor exception to this for an inside barrier when a path shares a bridge with a roadway. See FDM 11-35-1. Also, hand rails may be mounted 30 to 34 inches (0.75 - 0.8 m) above the deck.

If the bridge is over a roadway or railway, protective screening or fencing may be needed to prevent users from throwing objects onto the facility below. Protective screening should be 9 ft (2.7 m) high with a 2.5 ft (0.75 m) radius curve over the path starting at 6.5 ft (2.05 m). It should also provide ample sight distances between the structure and the approach ramps.



Figure 4-121: A simple rub rail mounted at handlebar height can divert out-of-control bicyclists back onto the pathway.

Approach ramp railings; If the shoulders of the path approach slope away precipitously or if the ramp is raised above the ground, railings will be necessary for path user protection. Ends of railings should be offset away from the adjoining path to reduce the chance of cyclists running into them (fig. 4-123). If this is not possible, object markers, as described in the MUTCD (Part 9), should be used at the railing ends. See Section 4.5 for additional information on railings.

Approach ramp slopes: Ramp slopes should be minimized to a 5% grade to the extent possible. This may be done by, for example, choosing a crossing with the least elevation change. For all underpass and overpass projects, ramps should be designed according to the *Americans with Disabilities Act Accessibility Guidelines (ADAAG)*.

To meet ADAAG, ramps should have a maximum running slope of 8.3%. Rises between level landings should be no greater than 30 in. (0.9 m). Landings should measure the full width of the facility and be at least 6 ft (1.8 m) long. Using numerous ramps to reach a high structure, however, will not serve the disabled well (fig. 4-122). In such cases, an elevator may need to be considered for high-use areas.

Bridge decking: On concrete bridge decks, expansion joints should be bicycle-safe and level with the deck. The deck should be broom finished or treated with a burlap drag to ensure a non-slippery surface. Metal decking may become slippery when wet or icy and is not generally appropriate for shared-use path bridges. Timbers may be used, but they should be laid crosswise — or at least 45° — to the direction of travel.

Bridge loading; Bridges should be designed for pedestrian live loadings. Where maintenance and emergency vehicles may be expected to cross the bridge, the design should accommodate them.



Figure 4-122: While this ramp provides landings and meets ADA slope limits, the overall length and height make it impossible to use for many disabled people.

Figure 4-123: Bridge railings should flare away from the path entrance. Also, plank decking should be placed at no less than a 45° angle to the direction of travel.

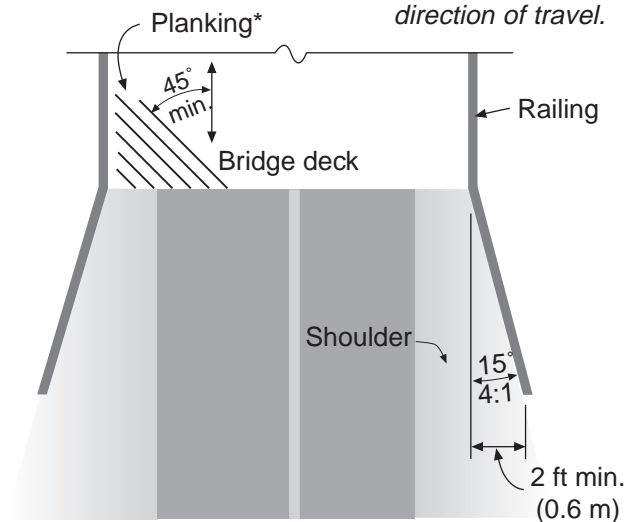

*If planking is used, it must be laid at least 45° to the direction of travel.

Figure 4-124: Adequate clearance is required for roadway and railway overpasses.

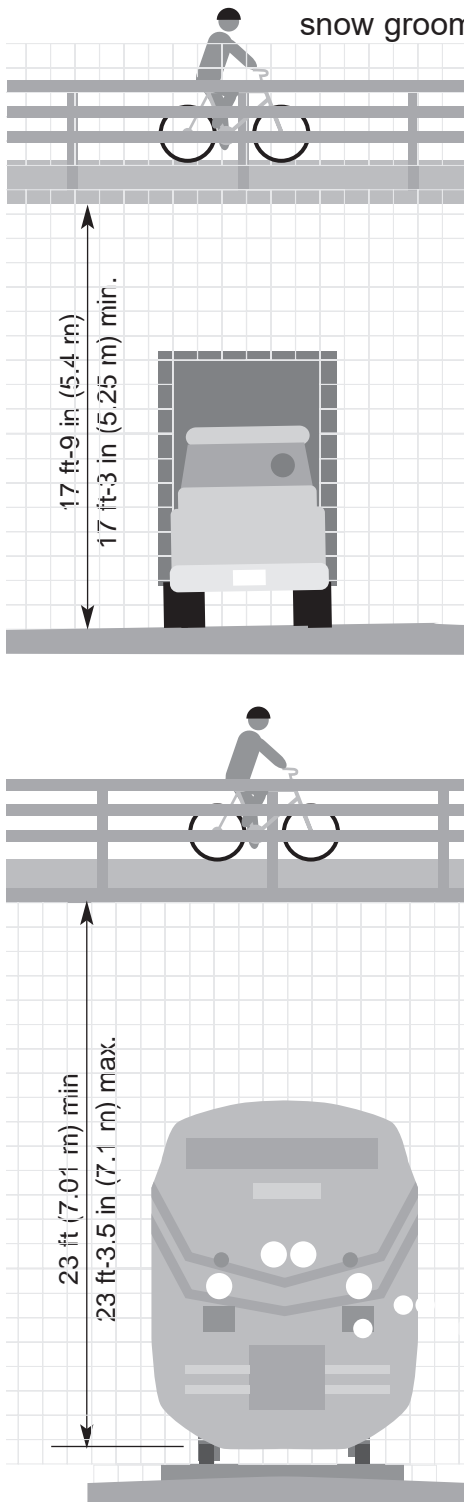

Vertical clearances: The superstructure of a bridge or overpass must provide adequate space for bicyclists to pass under. As mentioned in Section 4.5, there should be a minimum clearance of 10 ft (3 m) between the deck of the bridge and any overhead obstruction. However, maintenance and emergency vehicles requirements may govern. For example, the Wisconsin DNR generally uses 12 ft (3.6 m) for its trails to accommodate snow grooming equipment.

If a structure passes above a roadway, clearances underneath must account for the heights of traffic using that roadway. According to Procedure 11-35-1 of the WisDOT FDM, the desirable clearance is 17 ft - 9 in (5.4 m) and the minimum is 17 ft - 3 in (5.25 m). See figure 4-124 (top). Although there is some variation, a structure passing over a railroad (fig. 4-124 - bottom) must provide a minimum of 23 ft (7.1 m) of clearance; the maximum suggested clearance is 23 ft - 3.5 in (7.10m).

Bridge lighting: While not as critical as underpass lighting, bridge lighting can serve an important purpose. Areas adjacent to river crossings, for example, may be quite dark and users will need to see other bridge users or potential hazard lying on the surface. Similarly, overpasses should be well-lit to discourage vandalism or the throwing of objects onto a roadway or railway. See Section 4.13 for more information on lighting.

Retrofitting old bridges

In many cases, a structure that can no longer serve motor vehicle traffic may be quite adequate for path use. Some bridges have been retrofitted in place, while others have been disassembled and moved to a new site. Some designers have even used old railroad flat cars as bridges over small channels.

In general, retrofitted bridges will provide more than adequate clearances and support for a path structure, although a structural analysis should be done. Some modifications to the decking, as well as new railings and additional pedestrian-level lighting, may be appropriate.

4.16.2 Underpasses and tunnels

The following considerations apply to shared-use path underpasses and tunnels:



Vertical clearances: The standard vertical clearance for an underpass is 10 ft (3 m) and should be provided for adequate shy distance and to open up the underpass for more daylight. Extra height, however, may be needed for official motor vehicles access needs. For example, the Wisconsin DNR generally uses 12 ft (3.6 m) for its trails to accommodate snow grooming equipment.

Figure 4-125: Careful design can result in an open underpass that is inviting to users.

Basic width: Widths of tunnels and underpasses should consider user comfort as well as physical requirements. Too narrow a structure may appear dangerous and forbidding and discourage users. As a rule of thumb, a height to width ratio of 1:1.5 works well. The minimum clear width should be 12 ft. (3.6 m), and 14 ft (4.2 m) is strongly recommended (fig. 4-126). In rare situations where an 8 ft (3.6 m) wide path is being used to connect to the underpass, a 10 ft (3 m) wide width can be considered. The 8 ft wide path (and the 10 ft-wide underpass) needs to meet the width conditions established earlier in this guide.

The designer must also strongly consider the land use and usage characteristics of where the path is to judge whether a wider underpass may still be necessary in the moderate to long run. Greater width may be justified in areas with many potential users. Ramps should be as wide as the approaching path and shoulder.

Where physical constraints prevent providing adequate width, mitigating measures should be taken. These include reducing the structure's length, providing better sight distances and lighting levels, and using advance warning devices.

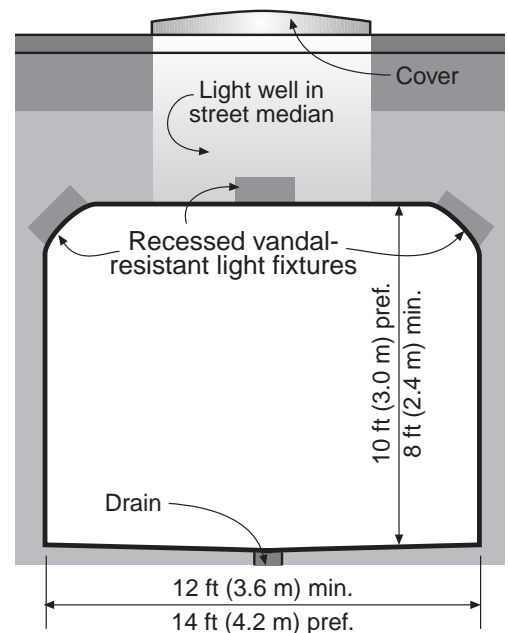

Figure 4-126: Standard dimensions and features for a shared-use trail underpass.

Length: The longer the underpass or tunnel, the less inviting and more intimidating it will be. To the extent possible, finding an alignment that minimizes length helps to produce a safer and more comfortable structure for users.

Ramp slopes: Ramp slopes and lengths should be minimized to the extent possible. This may be done through careful choice of approach alignment and, in some cases, raising the roadway or other feature above. For rural paths likely to have relatively little pedestrian or wheelchair use, the guidance found in Section 4.8 of this chapter should be used. For paths in urban and suburban areas or near popular recreational destinations, ramps should be designed according to the *Americans with Disabilities Act Accessibility Guidelines (ADAAG)*.

Figure 4-127: With good sight distances and visibility through to the other side, this structure provides a comfortable passage for bicyclists.



Sight distances: Being able to see through a structure to the exit and beyond is an important consideration for user comfort and safety (figures 4-125 and 4-127). To this end, approaches should align with the structure as closely as possible to increase sight distance and ramps should have gentle slopes, particularly near the bottom. Curves, where necessary, should occur well in advance of the entrance. And there should be no nooks or crannies within the structure to provide hiding places.

Flared entrances: Whenever possible, the sides of underpass and tunnel entrances should be flared to the outside for safety and to reduce the chance that a bicyclist may collide with the edge, as well as to improve visibility and interior light levels. Angles should be similar to those suggested for bridge railings (fig. 4-123).

Visibility and siting: The structure should be sited and designed for optimum visibility from nearby activity centers. This can help cut down on vandalism and increase user comfort and safety. At the same time, locating a structure near some land uses (e.g., bars and nightclubs) is generally not desirable.

Natural light: Increasing the levels of natural light in an underpass can significantly improve its utility and attractiveness for users. This may be accomplished with widely flared openings and skylights in the middle of the structure (fig. 4-128).

Lighting: For short underpasses or tunnels, relatively modest lighting may be all that is required, particularly if natural light is enhanced through the measures discussed above. However, the longer the structure, the greater the need for illumination. For transition purposes and to highlight the entrance ramps, lighting should also be provided on approaches. All lighting should be recessed and vandal-resistant. See Section 4.13 for more information on lighting.

Wall and ceiling treatments: Underpass wall and ceiling colors should be light to minimize both the objective and perceived darkness of the structure. It may also help to have darker walls and ceiling near entrances with a transition to lighter shades near the middle. In addition, surfaces should be easy to clean, particularly for removing graffiti. Porous surfaces are undesirable and difficult to effectively clean.

Floor surface and drainage: The floor of an underpass should have the same characteristics required of path surfaces, in general. However, because of the potential for drainage problems, a surface that does not become excessively slippery when wet is important. Proper drainage is exceedingly important, since wet silt deposits are the most common hazards for bicyclists using an underpass.

Figure 4-128: This skylight, which comes up into the roadway median above, makes the underpass more inviting.



Figure 4-129: This retrofitted barrier-separated path bridge shares an existing roadway bridge's structure.



4.16.3 Combining structures

Occasionally, an important path system barrier may be overcome by combining a shared-use path bridge with another structure. For instance, a path bridge over a river may be combined with a utility crossing (e.g., a sewer or water main), a railroad bridge, or a highway bridge.

In some cases, the two functions may be combined side-by-side (fig. 4-129) but in other cases, an over-under design works better (fig. 4-130). The choice of approach depends on a variety of factors, including:

- *available (and required) clearances (e.g., for waterway flood levels and boat traffic);*
- *load capabilities (particularly of existing structures); and*
- *the elevations of connecting facilities and the grades required to meet those elevations.*

When combining crossings, it is critical to protect the integrity and safety of each element. Highway (or railway) traffic, for example, must be kept separate from path traffic. The design should not violate the expectations of users of either element.

For instance, paths are often used by families with small children. To abruptly introduce these users into a highway environment would seriously compromise their safety. Similarly, most highway users would be unpleasantly surprised if they were suddenly confronted with young path users entering the roadway.



Figure 4-130: This path bridge spans a river under a railroad bridge. Attention must be paid to flood water levels and the river's navigability.

For these reasons, a separate path should not end at a roadway bridge, under the dangerous assumption that users will “find their way” across the structure. Continuity is an important safety factor.

Figures 4-131 and 4-132 show how a combined path/roadway bridge should work to keep the functions separate. Note that pedestrian and bicycle traffic related to the roadway corridor are provided for on the roadway bridge, itself.

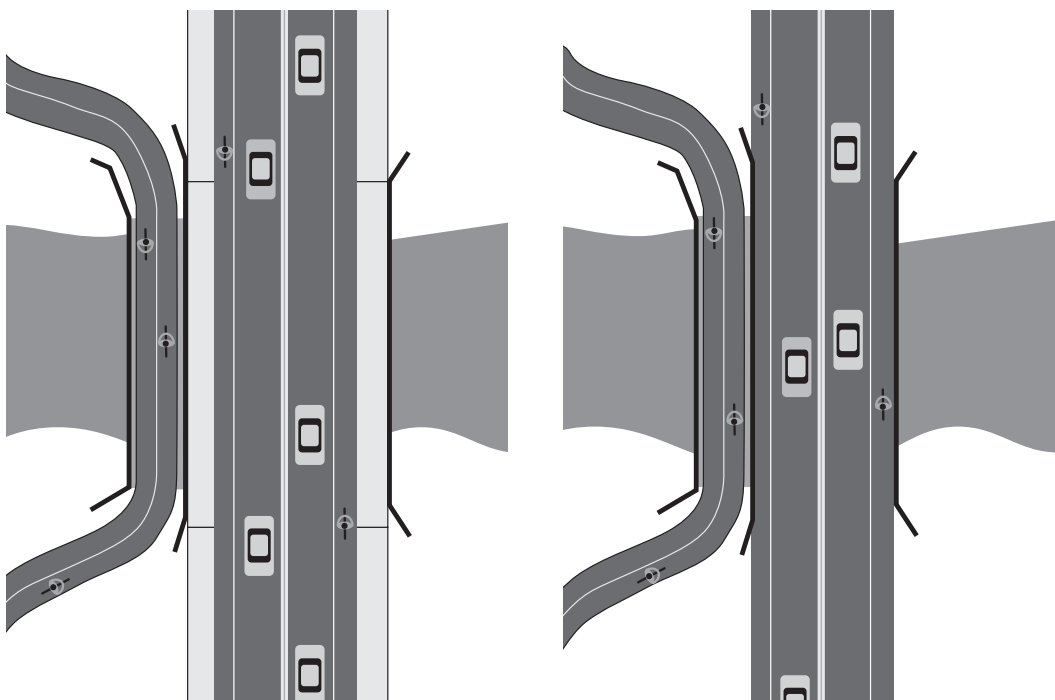

Figure 4-131 (left): A path/highway structure in an urban setting. Note sidewalk and bike lanes for pedestrians and bicyclists following the highway corridor.

Figure 4-132 (right): A path/highway structure in a rural setting.

By contrast, figure 4-133 shows the conflicts introduced when path users are directed onto a highway to use that facility's bridge. A similar problem is created when a separate bridge is provided for bicyclists using the roadway (fig. 4-134).

Figure 4-133 (left): Path users are directed onto a roadway bridge with unpredictable consequences.

Figure 4-134 (right): Roadway bicyclists are directed to a one-side bridge, also with unpredictable results.

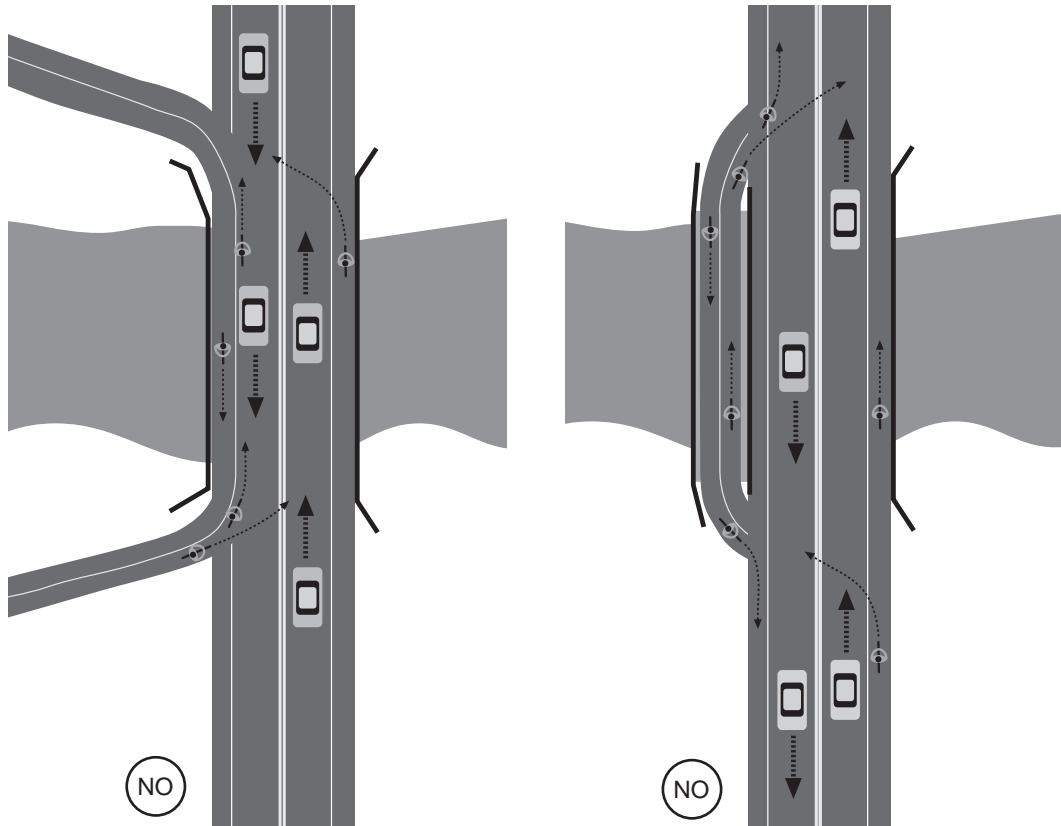

Such designs are generally inappropriate. They require the bicyclist to choose between two risky options:

Crossing the highway twice at a potentially high-speed location. Such crossing maneuvers introduce unnecessary risk for path users and may surprise and unnerve highway users.

Riding against traffic. This also introduces risk — for the bicyclist traveling against traffic and for any bicyclists riding with traffic. In addition, it requires the bicyclist to break the law.

4.16.4 Separation on Combined Structures

A fixed barrier is very often required to separate path traffic and highway traffic on a combined path/highway bridge. At higher motor vehicle speeds (i.e., 45 mph and above), a positive barrier between the uses becomes a critically important safety feature. At lower speeds, a simple curb and wide sidewalk may suffice to separate the uses.

For low- and high-speed structures: Figure 4-135 shows a standard separation treatment. The sloped face type “F” parapet is used to separate the uses. A 54 in.-high (1.3 m) barrier is preferred, but a 42 in. (1.1 m) height can be used. Under exceptional circumstances, a 32 in. (0.8 m) barrier may be used. To attain the minimum height of 42 in. (1.1 m), a short section of fencing is added to the top of the parapet. In this case, a 1 ft (0.3 m) minimum clear zone is provided on the path side of the barrier.

For low- to moderate-speed structures only: Figure 4-136 shows the low-speed situation. By using the standard WisDOT raised sidewalk section with a 5 ft (1.5 m) separation, the path and roadway may be separated to a reasonable degree (see FDM 11-35-1). In this situation, the need for a clear zone on the sidewalk side of the path is reduced by the separation space and the low curb.

Alternative low- to moderate-speed structure option: As a third option for lower-speed situations, a median-type separating device could be used. The median should be 5ft (1.5 m) wide, but can be reduced slightly for low-speed (≤ 30 mph), low-volume roadways and where there is a shoulder or bike lane on the bridge deck which provides a significant clear zone between the median and the travel lane (fig. 4-137).

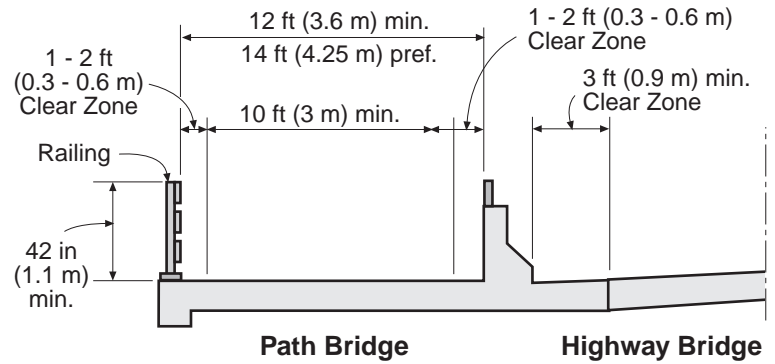

Combined Path/Highway Bridge with Barrier

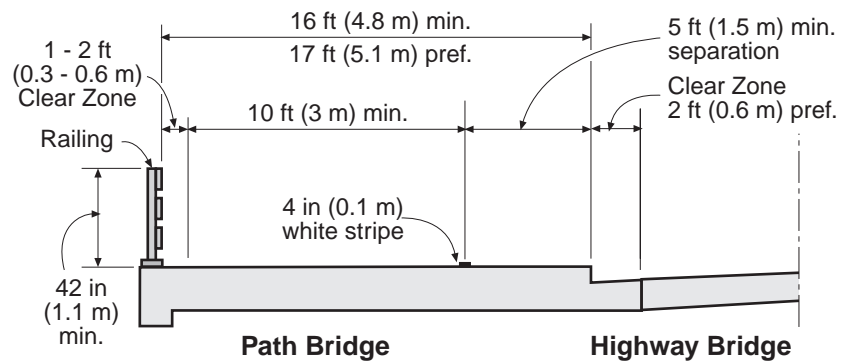

Optional Combined Path/Highway Bridge (*Highway Speed Limit ≤ 40 mph*)

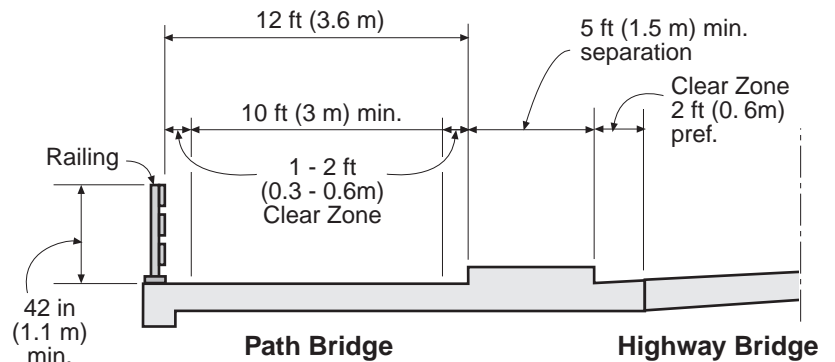

Combined Path/Highway Bridge with Median Separation (*Highway Speed Limit ≤ 40 mph*)

Figure 4-135 (top): Standard separation treatment includes a type “F” parapet.

Figure 4-136 (middle): An option for lower-speed roadways,

Figure 4-137 (bottom): Another low-speed option using a median separation.



Figure 4-138: Most paths are shared-use, varying only in the mix between bicyclists and pedestrians. A busy path like this one may be a good candidate for separating bikes and pedestrians.

4.17 Shared Use

A typical shared-use path's traffic may include bicyclists, in-line skaters, roller skaters, roller skiers, wheelchair users (both non-motorized and motorized) and pedestrians (people walking alone or in groups, people with baby strollers or walking dogs, joggers, runners, and more). As a result, it is useful for the designer to look at the facility from a variety of user points of view.

For example, rest stops, benches, drinking fountains, and other amenities need not be too close together for bicyclists, most of whom can travel a mile in 4 to 6 minutes (10-15 mph). But for many pedestrians, walking a mile will take between 20 and 30 minutes. For this reason, amenities will need to be closer in areas where significant pedestrian use is expected or where senior citizens are more likely to be found.

And, while having a park bench right next to a path's edge would be little trouble for a pedestrian, it creates a serious hazard for bicyclists. At the same time, bicyclists may have little difficulty stopping for stop signs but roller skiers do not stop quickly. For them, a low-volume rural facility with gentle curves and few crossings or interruptions works best.

4.17.1 Pedestrians and Bicyclists

Many paths can operate acceptably under "shared bicycle-pedestrian use" conditions. This is particularly true of facilities that carry low levels of user traffic and/or where bicycle speeds tend to be limited. Paths that link popular destinations or that pass next to major generators (e.g., schools, parks, or college campuses) can become quite crowded and chaotic. In these situations, a shared-use design approach may break down.

Some communities have found separating pedestrians from bicyclists necessary on certain high-use paths. The following are examples of situations that may warrant separation:

- *the route is used for fast bicycling (e.g., a commuter link to downtown or between a college campus and student housing) and passes close to a pedestrian traffic generator (e.g., an elementary school, restaurants, or office complex); and*
- *the route is largely contained within a park or urban riverfront with lots of potential pedestrian use and “exercise bicyclists.”*

On some facilities, striping and signing may be used to separate bicyclists and pedestrians on one relatively wide path (fig. 4-139 and 4-140). However, this is not nearly as effective as physical separation, particularly with high pedestrian volumes, and extra width may be needed to accommodate all users. In addition, pedestrians like to walk side-by-side and talk and this often leads them to encroach on the bicycle part of the path. (For striping and signing particulars, see Section 4.14.1.)



Figure 4-139: One common way to separate bicycles and pedestrians on a shared-use path. Stripes only work well with relatively low pedestrian and/or bicycle volumes. For more on this, see Section 4.14.1.

Figure 4-140: Typical widths for a path divided by striping.

Such designs typically give more space to bicyclists, and pedestrians may find their relatively narrow lane unappealing, particularly if it means being passed by fast bicyclists at close quarters. On the other hand, bicyclists may find the pedestrian area inviting to use for passing other bicyclists. For these reasons, trying to separate users in this manner may not work.

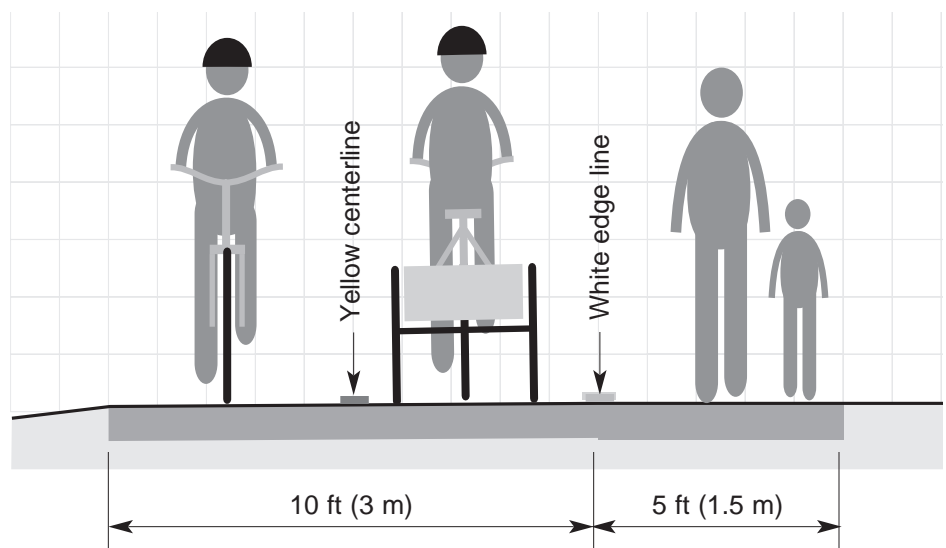

Path separated from walkway by edge line

Figure 4-141: Typical widths for a path divided by a grass berm.

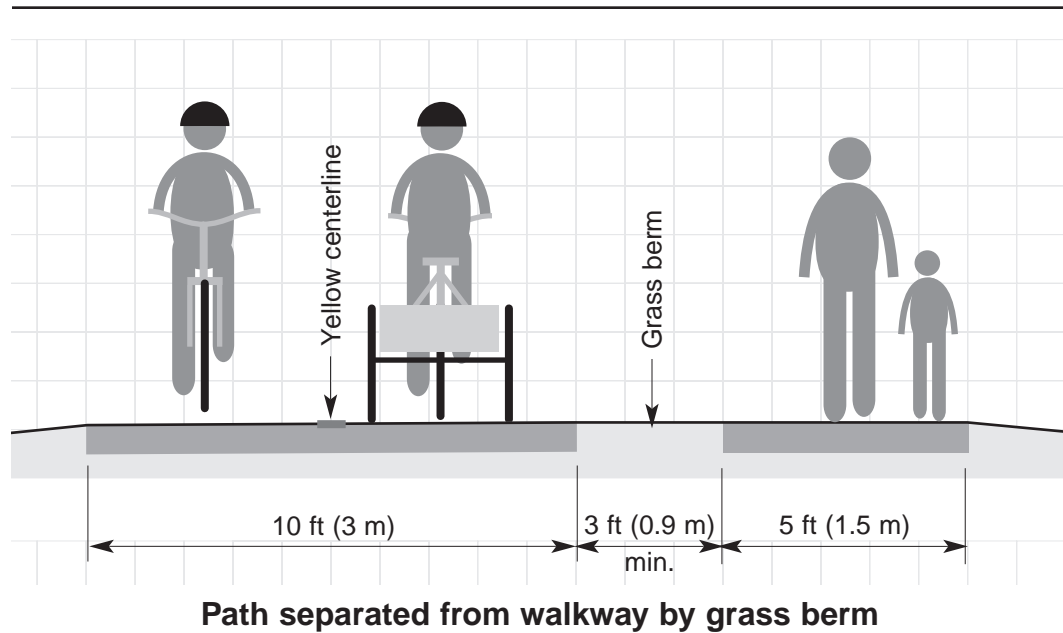

Figure 4-142: This popular path splits into bicycle and pedestrian segments where space permits.



Physical separation is often preferable over striping (fig. 4-141). In numerous communities, it has been accomplished through the use of individual paths for “wheels” and “heels.”

Typically, wheelchairs and baby strollers go with “heels” while in-line skaters go with “wheels.” The physical separation is typically a 3 ft (0.9 m) or greater grass berm (fig. 4-142).



4.17.2 Motorbikes and motorcycles

Even where lawful, it is undesirable to mix motorbikes or motorcycles with bicycles and pedestrians on a shared-use path. Facilities funded through federal funds cannot allow motorized use, except where local ordinances permit snowmobile use. Electric motor bicycles and wheelchairs are also exempt, but most trail sponsors in Wisconsin still do not allow motorized bicycle use unless the engine is disengaged. In general, the mix of speeds and the noise introduced by motorbikes detract from non-motorized users' enjoyment of the path.

Numerous agencies have attempted to physically block motorcycles from paths through the use of various types of barriers (fig. 4-143). However, a barrier that keeps motorcycles out will make path use more difficult and potentially hazardous for bicyclists, tricyclists, wheelchair users, and pedestrians. Proper path management, including enforcement where necessary, is a more appropriate approach to solving such potential problems.



Figure 4-143: A maze intended to discourage motorcyclists. In general, anything that will keep motorcyclists off a path will make use difficult for bicyclists, tricyclists, and wheelchair users.

Figure 4-144: Enforcement is a better approach than barriers and it can help avoid other potential problems (e.g., assaults or robberies).

Figure 4-145: Often, nothing special is needed to discourage motorists from using a path.



Figure 4-146: Regulatory signs like the R5-3 should be used at path entrances if problems arise.



R5-3

4.17.3 Motor vehicles

In general, it is easier to keep motor vehicles off shared-use paths than it is to keep motorcycles off. Some practitioners find that motor vehicle barriers of any kind are seldom necessary (fig. 4-145). Motorists, as a rule, are not particularly attracted to driving on paths and they can be subtly discouraged from doing so. To help identify the intersection as a non-motorized path crossing, a number of elements should be considered.

Signing and marking: Signing and marking are common elements. The most common is the R5-3 No Motor Vehicles sign (fig. 4-146). Other elements include the W11-1 Bicycle Warning sign, marked crosswalks, D11-1 Bike Route signs with M7-5 directional arrows, and Bike Xing pavement markings. See Section 4.14.1 - 4.14.3 for more information.

Tight returns or curb ramps: Simple design features can also help discourage motorists from turning on to a path. For example, curbed

Figure 4-147: The bollard in the middle of this path entrance will not stop motorists from entering. It is, however, highly visible and has the appropriate pavement markings. Still, other elements should be the first choice to discourage encroachment.



entrances with tight return radii (fig. 4-148) of 5 ft (1.5 m)] can make path entrances less attractive to drivers.

Similarly, curb ramps can discourage motorists. With the latter, it is important to make the transition between the roadway and the ramp smooth with gentle slopes on each side of the gutter pan.

Plantings; An additional measure to discourage motorists is low plantings on either side of the entrance. Low-growing shrubs that attain heights of 2 ft or so can visually narrow the path entrance and make motorists hesitate to try it. Fences that extend from the path area to the property line can also be used.

Split entrances: Another approach is to split the path entrance into two one-way paths near the intersection and provide a landscaped island in between (fig. 4-149 and 4-150). Low plantings can be used to discourage motorists from entering the path. These can be driven over by emergency vehicles but care must be taken to choose plants that will not grow tall, creating sight obstructions.

Medians: A raised median with a cut-through can also help discourage motorists from turning into a shared use path (fig. 4-150).

While any of these measures may not keep all motorists from entering a path, they can significantly reduce the potential problem. And, in many cases, that is all that will be needed.

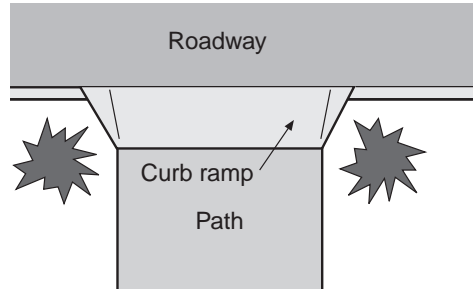
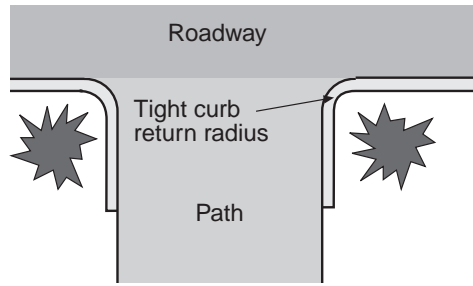
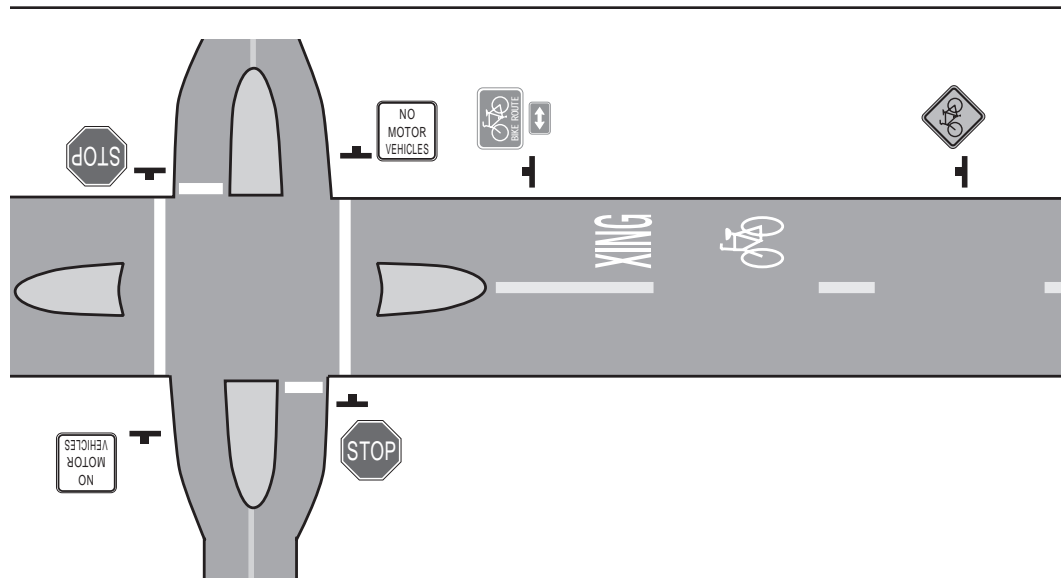

Figure 4-148: Two approaches to entrance design which can discourage most motorists from attempting to enter a shared-use path.



Figure 4-149: A split path entrance can, with proper low plantings, discourage motorists from entering.

Figure 4-150: A split path entrance and/or a median on the roadway can discourage motorist intrusion.



If a problem with motorist use of a path arises, the first action should be to evaluate current design features and determine if there is a facility problem and whether it may be eliminated. It is also important to identify where and how motorists are getting onto the path, as well as whether there is a particular reason for such use. For example, the path may provide a shortcut to an attractive destination (e.g., a fishing spot) or it may allow motorists to get around a barrier (e.g., a railroad line).

In addition, it may be possible to identify frequent users and target them for enforcement. In some cases, for example, a path may be used by a neighbor who knows it is wrong but finds the path a convenient shortcut. *[Often, path rules are self-enforcing, with bicyclists, pedestrians, and other neighbors taking the offender to task or contacting the police.]*

Once the situation is understood, proper design measures, as well as targeted enforcement steps, may be devised to stop the intrusion.

Figure 4-151: If bollards are necessary, they should be reflectorized, positioned in a highly visible location, and separated by 5 ft. (1.5 m).



Bollards: As a last resort, bollards may be considered (fig. 4-151). These should be reserved for locations with continual motorist encroachment where other approaches do not solve the problem. Since bollards can constitute a hazard and hamper maintenance, installations must be carefully designed.

If more than one is needed, three bollards should be used and must be spaced at least 5 ft. (1.5 m) apart to allow safe passage for bicyclists, adult tricycles, bicycle trailers, and wheelchair users (fig. 4-152).

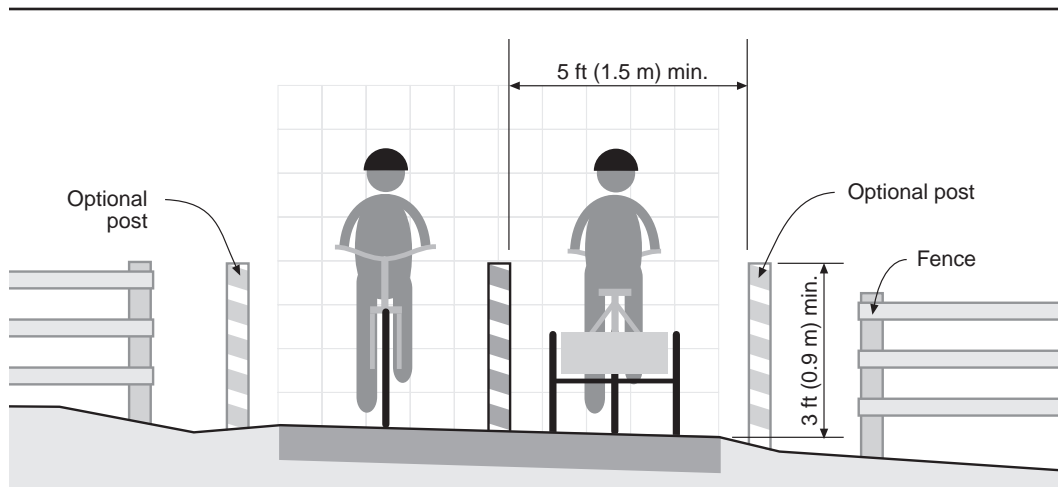

Figure 4-152: Reflectorized bollards must be at least 5 ft. (1.5 m) apart to allow bicyclists, tricyclists, bicyclists with trailers, and wheelchair users to pass.

Reflective pavement markings should be used to direct bicyclists away from the posts (fig. 4-58). Since bollards may be hard to see at dusk or at night, lighting is strongly recommended. Unlike the example in figure 4-153, bollards should be reflectorized for nighttime visibility and painted with bright colors for daytime.

Bollards should not be placed right at the intersection since they will distract bicyclists from looking for cross-traffic but should be set back beyond the roadway's clear zone. In this way, they will be close enough to the intersection to benefit from overhead lighting but far enough back not to constitute a distraction for bicyclists or a hazard for motorists.



Figure 4-153: Natural wood posts in unlit areas are hard to see.

Other barriers: If lighting is good, such things as decorative concrete garbage cans can serve as barriers (fig. 4-154). Because of their size, they are more noticeable than bollards.

Finally, separate gated entrances at key locations can provide a good solution for routine maintenance vehicle access. This can often work better than hinged or removable bollards, which can be damaged by abuse.



Figure 4-154: In well-lit areas, street furniture like decorative garbage cans can work better than bollards.

Fig. 4-155: Horses and bicyclists typically do not mix well on the same path. Separation is important to path success. Visual barriers like bushes and trees are even better than fences, since the horses do not see the bicyclists.



Figure 4-156: A bicyclist quietly passing these two horses from the rear could easily scare them.



4.17.4 Horses

Mixing horses and bicycles is not desirable on the same shared-use path. Bicyclists are often unaware of the need for slower speeds and additional operating space near horses. Horses can be easily startled if passed by a quiet bicyclist coming from behind (fig. 4-156). Proper trail etiquette is very important.

In addition, pavement requirements for bicycle travel are not suitable for horses. For these reasons, a bridle trail separate and, preferably, out of view from the shared-use path, is recommended (fig. 4-155). On lower-use rural paths, a separate bridle path several feet from the path's shoulder may work sufficiently well.

Figure 4-157 (right and left): Signs may be needed to identify appropriate corridors for pedestrians and bicyclists and horses.





Figure 4-158: Some paths are plowed while others are groomed for skiing or snowmobile use.

4.17.5 Cross-country skiers and snowmobiles

If a shared-use path is to safely accommodate bicyclists, pedestrians and wheelchair users in the winter, it needs to be relatively free of snow and ice. As a result, such a path cannot realistically be shared with snowmobilers (fig. 4-158). However, not all paths should necessarily be reserved for pedestrians and bicyclists.

Determining whether to plow paths or not should be based on a number of factors. These are some of the more important ones:

- *expected use by bicyclists and pedestrians;*
- *parallel options for bicyclists and pedestrians if the path is not passable; and*
- *state statute 81.15 regarding the liability for accumulation of snow and ice.*

For more information on maintenance issues and winter use, see *Appendix A*.

Figure 4-159: Lots of footprints and/or bicycle tracks in the snow are signs that a path should be plowed.



4.17.6 Shared Use paths and boardwalks

Boardwalks are often used to elevate paths over wetland areas. Typically these wetland areas are not navigable waterways. Boardwalks will *not* be considered "bridges" as long as no single span exceeds 20 feet (between faces of supports), and its height above ground and/or water is less than 10 feet. Boardwalks falling under these constraints will not be required to follow WisDOT's design requirements as set forth in the WisDOT Bridge Manual.

Boardwalk designs will, however be required to meet the following requirements:

- Railings are required when the height from the path to the adjacent grade exceeds 12". * If the height is 12" or less, a railing is not required, however minimum shoulder widths of 2' are then required if a railing is not provided. A short bumper rail (approximately 2" to 4" high) is required in the place of the railing. The rail should be placed outside of the shoulder area. The minimum width of the boardwalk is 12" from railing to railing.
- Boardwalks will be designed for a minimum pedestrian loading of 90 pounds per square foot. In addition, it is recommended that loadings for maintenance vehicles and emergency vehicles be considered (including the concentrated effect of tire loads).

If boardwalks will not be designed for emergency vehicles or for maintenance vehicles that are the size of standard pick-up trucks (or larger), then a community needs to establish a plan for maintaining these boardwalks and to access any potentially segmented portions of paths. This is necessary so that trail managers may reach trail users encountering a medical emergency or for security reasons.

Strategies for maintenance practices for lighter load boardwalks may include the use of small utility or compact tractors, neighborhood utility vehicles (NEVs), and light utility vehicles (LUVs). Winter maintenance for trails in urbanized areas must also be addressed before the opening of a trail since a failure to provide for the appropriate design treatments and loading capacities for a boardwalk may directly affect the ability and practicality of a community keeping a trail open during the winter.

* Some discretion may need to be applied in situations where the boardwalk elevation meets the 12" requirement for the vast majority of the length of a boardwalk, but simply because of variations in the ground below the boardwalk, there may be short stretches (less than 10' long) where the boardwalk may be elevated up to 18". If communities are contemplating the application of this minor variance, the condition of the ground surface must be part of that consideration – sand and grass are far better conditions for cyclists or pedestrians that go off the boardwalk than jagged rocks.

Emergency responders may also experience difficulties reaching people on those trails that are segmented by light load boardwalks. Strategies to overcome these issues are essential and include providing mile markers (see section 4.14.3) so that trail users can alert responders to their location on a path. If a path is segmented, then emergency responders must know which direction or closest access point they need to use to reach a user. Additional problems will occur on paths that are separated by two or more segments of light load boardwalks. Emergency responders (and maintenance workers) must be aware of these segments so that alternate plans of reaching the in-between segments of trail can be developed. A driveway or a roadway intersection may be helpful in accessing these segments.

Short segments of paths inaccessible by motor vehicle may be acceptable in rare cases if easily reached by foot. However, inaccessible segments that are longer than two hundred feet may significantly affect total response time in emergency situations.

Light load boardwalk segments that can easily be viewed from police squads, or in other cases, officers can drive their squad cars to the near end of a boardwalk, are two other strategies to overcome the inability of officers to actually drive their squads on the boardwalk itself.

Appendix A

Maintenance & Operations

A.1 General

The development of bicycle facilities has become more popular during the past decade among communities nationwide. Path systems have sprung up in the smallest towns and the biggest cities. On-road bicycle lanes have become a standard feature in some places. And such basic bicycling improvements as bicycle-sensitive traffic signals, bicycle-safe drainage grates, wide outside travel lanes, or well-marked shoulder areas, have become almost common.

As the popularity of such facilities has grown, the need for proper maintenance and operations has become obvious. An agency that builds a path, for instance, must know in advance who will take care of it and where the money will come from. To this end, it is vital to consider the costs of such on-going duties in proposals for new and enhanced facilities.

Historically, many paths and lanes have been built or marked only to fall into disrepair and, eventually, abandonment. These early lessons were expensive and unfortunate. These days, however, the necessary costs are being built into project and program budgets. Agencies have long since learned that there is no such thing as a self-maintaining bicycle facility.

Still, proper design and construction practices can reduce maintenance needs substantially. For instance, proper soil treatment beneath a new path can reduce the intrusion of vegetation and, as a result, may prolong pavement life. Similarly, paving 15 feet or so into unpaved driveways can keep most of the debris off a street's bicycle lanes. And using hydraulically-efficient bicycle-safe drainage grates can protect bicyclists while enhancing the removal of storm water runoff.

In addition, some facility maintenance tasks can be handled by small changes in existing practices. For example, street sweeping patterns may be adjusted slightly to take care of bicycle lanes. And some traffic signal crews carry a bicycle wheel in the truck to test new and modified signal systems for bicycle-sensitivity. Such changes do not require large investments – just thoughtful adjustments to existing practices.

Another important feature of a bicycle-friendly maintenance program should be the involvement of users in a positive way. Bicyclists should be encouraged to report maintenance problems on paths and roadways. A

central contact person with authority to authorize maintenance work should be designated to receive such reports. Developing a feedback mechanism (e.g., a “spot improvement” postcard program) can help identify problems and improve relations with the bicycling public. Some agency staff have noted that their spot improvement programs were the most popular things they did.

A.2 Planning and Budgeting

As an agency gains experience with bicycle facility maintenance and operations, they will learn to estimate future costs for their expanding system. Per mile costs for path sweeping or vegetation removal can be determined if accurate records are kept. Trash removal and emptying of containers can be predicted based on experience with nearby parks or other similar facilities. While seasons may change the level of attention required, there will be an increasing level of predictability as time goes by.

In addition, costs of such things as bicycle lane striping, marking, and signing can be estimated based on existing costs for similar items. Loop detectors buried in bicycle lanes to actuate traffic signals are similar to those buried in regular travel lanes and the costs are similar. Bicycle-safe drainage grates are sold by the same manufacturers as other styles and their costs are readily available.

One aspect that must be carefully considered involves maintenance practices that cannot be handled by existing methods. For instance, a city’s snow plows may be too large to use on a shared-use path. And some standard maintenance vehicles may not be able to reach certain areas of a network. For these reasons, it may be necessary to purchase special equipment or modify existing vehicles to handle the need. These costs should be planned for and maintenance and operations crews should be involved early in the process to anticipate problems before they arise.

The growth of bicycle facility mileage should be carefully watched to assure that funding for maintenance and operation keep up. While the special maintenance needs of on-road facilities are a relatively small part of the overall road maintenance budget, this is not the case with bicycle paths.

A.3 On-road facilities

On roadways with bicycle lanes, shoulders, or wide outside lanes, debris may accumulate near the right edge, where most bicyclists ride. Therefore, regular sweeping is necessary and the paths that operators take may need to be adjusted to take care of those areas. The sweeping schedule can vary, depending on local conditions, and should be based on observation of needs.

Pavement quality is also important for bicyclists. Potholes should be patched to a high standard, as should utility excavation work. In addition, pavement edges should be uniform and joint lines should be checked for hazards. Bicycle-oriented signs, striping, and marking should be routinely inspected and kept in good condition..

Routine roadway maintenance can help improve bicycle travel throughout a community. Several bicycle facilities described in this guide can be implemented during routine maintenance activities. When lane markings are restriped, consideration should be given to adjusting lane widths to provide bicycle lanes or wide curb lanes. Addition of edge lines can help delineate a shoulder. When shoulders are resurfaced, a smooth surface suitable for bicycle riding should be considered.

During the winter, bicycle lanes, shoulders, and the outer edges of curb lanes should be cleared of snow, like other parts of the road. Snow should not be left in these areas and should be removed as quickly as possible.

A.4 Shared-use paths

Shared-use paths may not be visible from nearby roadways and agency personnel may not know if a problem has arisen. As a result, it is important to routinely inspect paths for maintenance problems like overhanging vegetation, debris on the surface, sight obstructions near curves, etc. Use patterns should also be observed for indications that problems may be arising. Bicyclists may cut particular curves or may avoid certain areas. Such behavior may be the result of a maintenance problem or a design flaw that could be rectified.

Pavement markings tend to last longer on paths than on roadways, depending on plowing activity in the winter and other factors. As a result, stripes may not need to be re-done each year. Signage, however, may be popular targets for vandalism or theft. Particularly important hazard markers or regulatory signs should be inspected regularly to ensure they are still in place.

Lighting, particularly at key intersections or hazardous locations, should be checked regularly. Lights should be maintained to ensure reliable operation and should be kept clean and replaced as required to ensure proper luminescence.

Sight distances at key junctures – intersections with roadways, on the insides of curves – should not be impaired by encroaching trees, shrubs and tall grass. Maintaining adequate clear zones on each side of a path can preserve the facility's effective width and reduce the potential for

head-on collisions. Tree branches should be trimmed to allow room for seasonal growth without encroaching onto the trail. Seeded and sodded areas near paths should be mowed regularly.

Patching and grading of paths should be much less demanding than similar roadway operations. Hand operated equipment may be adequate but it is important that finished patches be flush with the surface and use materials that will not grip in-line or roller skates, especially for longitudinal fractures. The patch's surface should have similar skid resistance characteristics to the adjoining path's surface.

The presence of ruts in the pavement may indicate an improperly designed or built path, or that heavy vehicles are using it. Ruts should be removed to give a satisfactory result and avoid recurrence. Re-paving may be necessary to solve major problems. Pavement edges should be maintained to preserve the full paved width; shoulders should not be allowed to wash away, exposing the edges to potential damage or possibly causing users to crash.

Paths built across irregular or hilly land may encounter drainage problems. Heavy storms may wash out portions of path or leave a thick layer of debris on the surface. Sunken areas may indicate problems beneath the pavement and should be repaired with care. Providing culverts or small bridges may help avoid problems in the future. Drainage ways should be inspected for blockages or other problems.

Drainage grates are not generally found on path surfaces and should generally be offset from the surface. However, grates should be bicycle-safe even if they are several feet away from the pavement edge. Bicyclists may leave the pavement for a variety of reasons and should not have to worry about a dangerous grate.

Generally, shared-use paths do not collect debris to the extent that roadways do. However, certain locations (e.g., near unpaved roadway crossings) may be problem sites and may need occasional attention. In addition, debris at certain critical locations should be monitored. For example, gravel should not be allowed to accumulate on curves or at intersections. At those locations, preventative measures should be taken to keep debris off the path all together.

Winter use varies according to local conditions. In some communities (e.g., Eau Claire, Madison), paths are plowed regularly and are used frequently by bicyclists and pedestrians. Heavily-used paths that serve key destinations should be considered first for plowing. Even paths that serve only occasional use should be considered for snow removal if the path is the only means of making a key connection (e.g., crossing a bridge).

Lower priority may be given to isolated paths that serve recreational users who must travel long distances to use them. In these cases, managers may allow want to allow use by cross country skiers or snowmobile operators as long as all applicable laws are followed.

To ensure that winter use is properly accommodated, agencies must clearly understand who will maintain what path. For paths along state highways, a municipality will have the responsibility for maintenance. Winter use and snow removal frequency will be determined by the municipality after considering the following factors:

- *Expected use by bicyclists and pedestrians;*
- *Parallel options for bicyclists and pedestrians if the path is not passable; and*
- *State statute 81.15 regarding the liability for accumulation of snow.*

A maintenance plan is crucial to success. And pavement structure must be designed for snow plow vehicle loading.

Trash receptacles should be located where they will be needed and where they can be easily emptied. Typical locations for trash barrels include rest areas and parks, scenic overlooks, and trail heads. Paths should be kept free of litter and debris.

Generally, path-sides should be given a thorough “Spring cleanup” and should be checked as needed. Fallen branches or other debris should be removed as soon as possible after the problem has been reported. User groups may wish to help out on a regular basis and their efforts should be encouraged.

Fencing: Fencing along paths should be maintained in the same manner as highway fencing.

Structures like bridges and underpasses should be inspected regularly for vandalism, graffiti, structural decay, and missing elements (e.g., lights, railings, signs). Those in isolated locations may be the targets of more abuse than facilities in more popular spots. For these reasons, solving such problems in advance is the best approach. Surfaces should repel paint, lighting should be hard to damage, and other parts and pieces should not be easy to remove.

If a path has steps or ramps, these should be maintained at a level that will safely accommodate users. Wheelchair ramps should be kept in good condition and graded areas should receive adequate attention.

Some shared-use paths may need occasional (or frequent) enforcement attention. For example, unauthorized vehicles may be using the path to get to a recreational location. Or certain areas may be isolated and potential sites for crimes of violence. The experience with paths is generally positive, with few crimes beyond what is normally found in the area. However, it may be good for the local police bicycle patrol to use the paths regularly to establish their presence.

APPENDIX B

Traffic conditions & bridge accommodations

Bicyclists' needs should be considered on a routine basis for all roadways and structures (except those on highways where bicyclists are prohibited). However, prioritizing candidate structures as part of developing a schedule for improvements should be based on traffic conditions; land use and the transportation system; and geometrics.

B.1 Traffic conditions

Bicycle traffic volume (potential or actual): A structure on a popular bicycling route is a better candidate than one on a road with little or no potential for bicycle use. At the same time, current bicycle volumes may be misleading indicators of desired use. Bicyclists may avoid using a narrow high-speed, high-volume structure out of fear.

Bicycle crash experience: Relatively few of those serious bicycle crashes that result in an emergency room visit are reported to the police. As a result, a structure with a history of reported bicycle crashes is likely to be the site of many unreported crashes as well and should receive close scrutiny.

Motor vehicle traffic volume: A high-volume structure is more likely to need bicycle accommodations than a low-volume one, due to the increased likelihood of passing conflicts, not to mention the stress of bicycling on a busy structure.

Percent of truck and/or RV traffic: A structure with a high percentage of truck and/or RV traffic is more likely to need bicycle accommodations than one with little or no such traffic. Wind-blast effects of large vehicles can cause bicyclists to lose control.

Traffic speed: High traffic speeds (i.e., over 45mph) are associated with a significant percentage of bicycling fatalities and structures on such routes need close attention.

B.2 Land use and the transportation system

Proximity to bicycle traffic generators: A structure that serves many nearby residents and connects to popular recreation or commercial areas is likely to attract more bicycle use than one far from any community.

Alternate routes: If there are no suitable alternate routes, the importance of a particular structure will be greater than if there are numerous options.

Connecting roadways: A structure that connects only segments of free-way or expressway is less likely to be in demand than one that connects surface streets, like collectors or arterials.

Bicycle accommodations: A structure that connects existing or planned bicycle facilities (e.g., bicycle lanes or routes) is a good candidate for bicycle-related improvements.

B.3 Geometrics:

Length: The longer a particular structure is, the less use it will get from casual short-distance bicyclists and the more use it will get from tourists and other long-distance cyclists.

Elevation: Bridges that arch high for the passage of ships or tunnels that drop steeply under a river are less attractive for most bicyclists than are flatter structures. However, on steep structures, the presence of slow-moving bicyclists on the ascent and fast moving bicyclists on the descent must be considered.

Width: Because passing opportunities are more limited on two-lane structures than on multi-lane structures, they are more likely locations for bicycle/motor vehicle conflicts.

Appendix C

Wisconsin Statutes on Bicycle Equipment and Use

The statutes shown in this material have been generated from the original data base of the 1989-90 Wisconsin Statutes, but may not be an exact duplication. Please refer to the 1989-90 Wisconsin Statutes for the official text.

85.07 Highway safety coordination.

(4) BICYCLE RULES. The department shall publish literature setting forth the state rules governing bicycles and their operation and shall distribute and make such literature available without charge to local enforcement agencies, safety organizations, and schools and to any other person upon request.

340.01 Words and phrases defined. In s.23.33 and chs.340 to 349 and 351, the following words and phrases have the designated meanings unless a different meaning is expressly provided or the context clearly indicates a different meaning:

(5) "Bicycle" means every device propelled by the feet acting upon pedals and having wheels any 2 of which are not less than 14 inches in diameter.

(5e) "Bicycle lane" means that portion of a roadway set aside by the governing body of any city, town, village or county for the exclusive use of bicycles or other modes of travel where permitted under s.349.23 (2) (a) and so designated by appropriate signs and markings.

(5m) "Bike route" means any bicycle lane, bicycle way or highway which has been duly designated by the governing body of any city, town, village or county and which is identified by appropriate signs and markings.

(5s) "Bicycle way" means any path or sidewalk or portion thereof designated for the use of bicycles by the governing body of any city, town, village or county.

(74) "Vehicle" means every device in, upon or by which any person or property is or may be transported or drawn upon a highway, except railroad trains. A snowmobile shall not be considered a vehicle except for purposes made specifically applicable by statute.

346.02 Applicability of chapter.

(4) APPLICABILITY TO PERSONS RIDING BICYCLES AND MOTOR BICYCLES.

(a) Subject to the special provisions applicable to bicycles, every person riding a bicycle upon a roadway is granted all the rights and is subject to all the duties which this chapter grants or applies to the operator of a vehicle, except those provisions which by their express terms apply only to motor vehicles or which by their very nature would have no application to bicycles. For purposes of this chapter, provisions which apply to bicycles also apply to motor bicycles, except as otherwise expressly provided.

(b) Provisions which apply to the operation of bicycles in crosswalks under ss. 346.23, 346.24, 346.37 (1) (a) 2, (c) 2 and (d) 2 and 346.38 do not apply to motor bicycles.

346.075 Overtaking and passing bicycles and motor buses.

(1) The operator of a motor vehicle overtaking a bicycle proceeding in the same direction shall exercise due care, leaving a safe distance, but in no case less than 3 feet clearance when passing the bicycle and shall maintain clearance until safely past the overtaken bicycle.

346.16 Use of controlled-access highways, expressways and freeways.

(1) No person shall drive a vehicle onto or from a controlled-access highway, expressway or freeway except through an opening provided for that purpose.

(2) (a) Except as provided in par. (b), no pedestrian or person riding a bicycle or other non-motorized vehicle and no person operating a moped or motor bicycle may go upon any expressway or freeway when official signs have been erected prohibiting such person from using the expressway or freeway.

(b) A pedestrian or other person under par. (a) may go upon a portion of a hiking trail, cross-country ski trail, bridle trail or bicycle trail incorporated into the highway right-of-way and crossing the highway if the portion of the trail is constructed under s. 84.06 (l 1).

346.17 Penalty for violating sections 346.04 to 346.16.

(2) Any person violating ss. 346.05, 346.07 (2) or (3), 346.08 to 346.11, 346.13 (2) or 346.14 to 346.16 may be required to forfeit not less than \$30 nor more than \$300.

(4) Any person violating s. 346.075 may be required to forfeit not less than \$25 nor more than \$200 for the first offense and not less than \$50 nor more than \$500 for the 2nd or subsequent violation within 4 years.

346.23 Crossing controlled Intersection or crosswalk.

(1) At an intersection or crosswalk where traffic is controlled by traffic control signals or by a traffic officer, the operator of a vehicle shall yield the right-of-way to a pedestrian, or to a person who is riding a bicycle in a manner which is consistent with the safe use of the crosswalk by pedestrians, who has started to cross the highway on a green or "Walk" signal and in all other cases pedestrians and bicyclists shall yield the right-of-way to vehicles lawfully proceeding directly ahead on a green signal. No operator of a vehicle proceeding ahead on a green signal may begin a turn at a controlled intersection or crosswalk when a pedestrian or bicyclist crossing in the crosswalk on a green or "Walk" signal would be endangered or interfered with in any way. The rules stated in this subsection are modified at intersections or crosswalks on divided highways or highways provided with safety zones in the manner and to the extent stated in sub. (2).

(2) At intersections or crosswalks on divided highways or highways provided with safety zones where traffic is controlled by traffic control signals or by a traffic officer, the operator of a vehicle shall yield the right-of-way to a pedestrian or bicyclist who has started to cross the roadway either from the near curb or shoulder or from the center dividing strip or a safety zone with the green or "Walk" signal in the pedestrian's or bicyclist's favor.

346.24 Crossing at uncontrolled Intersection or crosswalk.

(1) At an intersection or crosswalk where traffic is not controlled by traffic control signals or by a traffic officer, the operator of a vehicle shall yield the right-of-way to a pedestrian, or to a person riding a bicycle in a manner which is consistent with the safe use of the crosswalk by pedestrians, who is crossing the highway within a marked or unmarked crosswalk.

(2) No pedestrian or bicyclist shall suddenly leave a curb or other place of safety and walk, run or ride into the path of a vehicle which is so close that it is difficult for the operator of the vehicle to yield.

(3) Whenever any vehicle is stopped at an intersection or crosswalk to permit a pedestrian or bicyclist to cross the roadway, the operator of any other vehicle approaching from the rear shall not overtake and pass the stopped vehicle.

346.25 Crossing at place other than crosswalk. Every pedestrian or bicyclist crossing a roadway at any point other than within a marked or unmarked crosswalk shall yield the right-of-way to all vehicles upon the roadway.

346.30 Penalty for violating sections 346.23 to 346.29.

(1) 2. Any operator of a bicycle violating s. 346.23, 346.24 or 346.25 may be required to forfeit not more than \$20.

346.34 Turning movements and required signals on turning and stopping.

(1) TURNING.

(a) No person may:

1. *Turn a vehicle at an intersection unless the vehicle is in proper position upon the roadway as required in s. 346.31.*

2. *Turn a vehicle to enter a private road or driveway unless the vehicle is in proper position on the roadway as required in s. 346.32.*

3. *Turn a vehicle from a direct course or move right or left upon a roadway unless and until such movement can be made with reasonable safety.*

(b) In the event any other traffic may be affected by such movement, no person may so turn any vehicle without giving an appropriate signal in the manner provided in s. 346.35. When given by the operator of a vehicle other than a bicycle, such signal shall be given continuously during not less than the last 100 feet traveled by the vehicle before turning. The operator of a bicycle shall give such signal continuously during not less than the last 50 feet traveled before turning.

(2) STOPPING. No person may stop or suddenly decrease the speed of a vehicle without first giving an appropriate signal in the manner provided in s. 346.35 to the operator of any vehicle immediately to the rear when there is opportunity to give such signal. This subsection does not apply to the operator of a bicycle approaching an official stop sign or traffic control signal.

346.35 Method of giving signals on turning and stopping. Whenever a stop or turn signal is required by s. 346.34, such signal may in any event be given by a signal lamp or lamps of a type meeting the specifications set forth in s. 347.15. Except as provided in s. 347.15 (3m), such signals also may be given by the hand and arm in lieu of or in addition to signals by signal lamp. When given by hand and arm, such signals shall be given from the left side of the vehicle in the following manner and shall indicate as follows:

- (1) Left turn-Hand and arm extended horizontally.
- (2) Right turn-Hand and arm extended upward.
- (3) Stop or decrease speed-Hand and arm extended downward.

346.36 Penalty for violating sections 346.31 to 346.35.

- (2) Any operator of a bicycle violating ss. 346.31 to 346.35 may be required to forfeit not more than \$20.

346.37 Traffic-control signal legend.

(1) Whenever traffic is controlled by traffic control signals exhibiting different colored lights successively, or with arrows, the following colors shall be used and shall indicate and apply to operators of vehicles and pedestrians as follows:

(a) Green.

1. *Vehicular traffic facing a green signal may proceed straight through or turn right or left unless a sign at such place prohibits either such turn, but vehicular traffic shall yield the right of way to other vehicles and to pedestrians lawfully within the intersection or an adjacent crosswalk at the time such signal is exhibited.*
2. *Pedestrians, and persons who are riding bicycles in a manner which is consistent with the safe use of the crosswalk by pedestrians, facing the signal may proceed across the roadway within any marked or unmarked crosswalk.*

(b) Yellow. When shown with or following the green, traffic facing a yellow signal shall stop before entering the intersection unless so close to it that a stop may not be made in safety.

(c) Red.

1. *Vehicular traffic facing a red signal shall stop before entering the crosswalk on the near side of an intersection, or if none, then before entering the intersection or at such other point as may be indicated by a clearly visible sign or marking and shall remain standing until green or other signal permitting movement is shown.*
2. *No pedestrian or bicyclist facing such signal shall enter the roadway unless he or she can do so safely and without interfering with any vehicular traffic.*
3. *Vehicular traffic facing a red signal at an intersection may, after stopping as required under subd. 1, cautiously enter the intersection to make a right turn into the nearest lawfully available lane for traffic moving to the right or to turn left from a one-way highway into the nearest lawfully available lane of a one-way highway on which vehicular traffic travels to the left. No turn may be made on a red signal if lanes of moving traffic are crossed or if a sign at the intersection prohibits a turn. In making a turn on a red signal vehicular traffic shall yield the right-of-way to pedestrians and bicyclists lawfully within a crosswalk and to other traffic lawfully using the intersection.*

(d) Green arrow.

1. *Vehicular traffic facing a green arrow signal may enter the intersection only to make the movement indicated by the arrow but shall yield the right-of-way to pedestrians and bicyclists lawfully within a crosswalk and to other traffic lawfully using the intersection. When the green arrow signal indicates a right or left turn traffic shall cautiously enter the intersection.*
2. *No pedestrian or bicyclist facing such signal shall enter the roadway unless he or she can do so safely and without interfering with any vehicular traffic.*

(2) In the event an official traffic signal is erected and maintained at a place other than an intersection, the provisions of this section are applicable except as to those provisions which by their nature can have no application. Any stop required shall be made at a sign or marking on the pavement indicating where the stop shall be made, but in the absence of any such sign or marking the stop shall be made at the signal.

346.38 Pedestrian control signals. Whenever special pedestrian control signals exhibiting the words "Walk" or "Don't Walk" are in place, such signals indicate as follows:

- (1) WALK. A pedestrian, or a person riding a bicycle in a manner which is consistent with the safe use of the crossing by pedestrians, facing a "Walk" signal may proceed across the roadway or other vehicular crossing in the direction of the signal and the operators of all vehicles shall yield the right-of-way to the pedestrian or bicyclist.
- (2) DON'T WALK. No pedestrian or bicyclist may start to cross the roadway or other vehicular crossing in the direction of a "Don't Walk" signal, but any pedestrian or bicyclist who has partially completed crossing on the "Walk" signal may proceed to a sidewalk or safety zone while a "Don't Walk" signal is showing.

346.43 Penalty for violating sections 346.37 to 346.42.

- (1)
 - (b) *2. Any operator of a bicycle violating s. 346.37, 346.38 or 346.39 (duty to obey traffic lights) may be required to forfeit not more than \$20.*

346.47 When vehicles using alley or non-highway access to stop.

(1) The operator of a vehicle emerging from an alley or about to cross or enter a highway from any point of access other than another highway shall stop such vehicle immediately prior to moving on to the sidewalk or on to the sidewalk area extending across the path of such vehicle and shall yield the right-of-way to any pedestrian or bicyclist and upon crossing or entering the roadway shall yield the right-of-way to all vehicles approaching on such roadway.

346.49 Penalty for violating ss. 346." to 346.485.

- (1)
 - (b) Any operator of a bicycle violating s. 346.46 (duty to obey stop signs) may be required to forfeit not more than \$20.
- (2)
 - (b) Any operator of a bicycle violating s. 346.44 (duty to stop at signals indicating approach of train) may be required to forfeit not more than \$20.

346.59 Minimum speed regulation.

(2) The operator of a vehicle moving at a speed so slow as to impede the normal and reasonable movement of traffic shall, if practicable, yield the roadway to an overtaking vehicle whenever the operator of the overtaking vehicle gives audible warning with a warning device and shall move at a reasonably increased speed or yield the roadway to overtaking vehicles when directed to do so by a traffic officer.

346.60 Penalty for violating sections 346.57 to 346.595

- (5)
 - (a) Any operator of a bicycle who violates s. 346.57 (speed limits) may be required to forfeit not more than \$20.
 - (b) Any operator of a bicycle who violates s. 346.59 may be required to forfeit not more than \$10.

346.77 Responsibility of parent or guardian for violation of bicycle and play vehicle regulations. No parent or guardian of any child shall authorize or knowingly permit such child to violate any of the provisions of ss. 346.78 to 346.804 and 347.489.

346.78 Play vehicles not to be used on roadway. No person riding upon any play vehicle may attach the same or himself or herself to any vehicle upon a roadway or go upon any roadway except while crossing a roadway at a crosswalk.

346.79 Special rules applicable to bicycles. Whenever a bicycle is operated upon a highway, bicycle lane or bicycle way the following rules apply:

- (1) A person propelling a bicycle shall not ride other than upon or astride a permanent and regular seat attached thereto.
- (2)
 - (a) Except as provided in par. (b) no bicycle may be used to carry or transport more persons at one time than the number for which it is designed.
 - (b) In addition to the operator, a bicycle otherwise designed to carry only the operator may be used to carry or transport a child seated in an auxiliary child's seat or trailer designed for attachment to a bicycle if the seat or trailer is securely attached to the bicycle according to the directions of the manufacturer of the seat or trailer.
- (3) No person operating a bicycle shall carry any package, bundle or article which prevents the operator from keeping at least one hand upon the handle bars.
- (4) No person riding a bicycle shall attach himself or his bicycle to any vehicle upon a roadway.
- (5) No person may ride a moped or motor bicycle with the power unit in operation upon a bicycle way.

346.80 Riding bicycle on roadway.

- (1) Unless preparing to make a left turn, every person operating a bicycle upon a roadway carrying 2-way traffic shall ride as near as practicable to the right edge of the unobstructed traveled roadway, including operators who are riding 2 abreast where permitted under sub. (2). On one-way roadways, the operator of the bicycle shall ride as near as practicable to the right edge or left edge of the unobstructed traveled roadway, including operators who are riding 2 abreast where permitted under sub. (2). Every person operating a bicycle upon a roadway shall exercise due care when passing a standing vehicle or one proceeding in the same direction, allowing a minimum of 3 feet between the bicycle and the vehicle.
- (2) Persons riding bicycles upon a roadway shall ride single file on all roadways which have center lines or lane lines indicated by painting or other markings and in all unincorporated areas. On roadways not divided by painted or other marked center lines or lane lines, bicycle operators may ride 2 abreast in incorporated areas.
- (4) No person may operate a bicycle or moped upon a roadway where a sign is erected indicating that bicycle or moped riding is prohibited.
- (5) Except as provided in ss. 346.23, 346.24, 346.37 and 346.38, every rider of a bicycle shall, upon entering on a highway, yield the right-of-way to motor vehicles.

346.802 Riding bicycle on bicycle lane.

- (1)
 - (a) Unless 2-way traffic is authorized under par. (b), every person operating a bicycle upon a bicycle lane shall ride in the same direction in which vehicular traffic on the lane of the roadway nearest the bicycle lane is traveling.
 - (b) The governing body of any city, town, village or county may authorize 2-way traffic on any portion of a roadway which it has set aside as a bicycle lane. Appropriate traffic signs shall be installed on all bicycle lanes open to 2-way traffic.
- (2)
 - (a) Unless otherwise provided under par. (b), a person operating a bicycle may enter or leave a bicycle lane only at intersections or at driveways adjoining the bicycle lane.
 - (b) A person may leave a bicycle lane at any point by dismounting from the bicycle and walking it out of the lane. A person may enter a bicycle lane at any point by walking his bicycle into the lane and then mounting it.
- (3) Every person operating a bicycle upon a bicycle lane shall exercise due care and give an audible signal when passing a bicycle rider proceeding in the same direction.
- (4) Every operator of a bicycle entering a bicycle lane shall yield the right-of-way to all bicycles in the bicycle lane. Upon leaving a bicycle lane, the operator of a bicycle shall yield the right-of-way to all vehicles and pedestrians.

346.803 Riding bicycle on bicycle way.

- (1) Every person operating a bicycle upon a bicycle way shall:
 - (a) Exercise due care and give an audible signal when passing a bicycle rider or a pedestrian proceeding in the same direction.
 - (b) Obey each traffic signal or sign facing a roadway which runs parallel and adjacent to a bicycle way.
- (2) Every person operating a bicycle upon a bicycle way open to 2-way traffic shall ride on the right side of the bicycle way.
- (3) Every operator of a bicycle entering a bicycle way shall yield the right-of-way to all bicycles and pedestrians in the bicycle way.

346.804 Riding bicycle on sidewalk. When local authorities under s. 346.94 (1) permit bicycles on the sidewalk, every person operating a bicycle upon a sidewalk shall yield the right-of-way to any pedestrian and shall exercise due care and give an audible signal when passing a bicycle rider or pedestrian proceeding in the same direction.

346.82 Penalty for violating sections 346.77 to 346.804.

- (1) Any person violating ss. 346.77, 346.79 (1) to (3) or 346.80 to 346.804 may be required to forfeit not more than \$20.
- (2) Any person violating s. 346.78 or 346.79 (4) may be required to forfeit not less than \$10 nor more than \$20 for the first offense and not less than \$25 nor more than \$50 for the 2nd or subsequent conviction within a year.

346.94 Miscellaneous prohibited acts.

- (1) **DRIVING ON SIDEWALK.** The operator of a vehicle shall not drive upon any sidewalk area except at a permanent or temporarily established driveway unless permitted to do so by the local authorities.

(11) TOWING SLEDS, ETC. No person shall operate any vehicle or combination of vehicles upon a highway when such vehicle or combination of vehicles is towing any toboggan, sled, skis, bicycle, skates or toy vehicle bearing any person.

(12) DRIVING ON BICYCLE LANE OR BICYCLE WAY. No operator of a motor vehicle may drive upon a bicycle lane or bicycle way except to enter a driveway or to enter or leave a parking space located adjacent to the bicycle lane or bicycle way. Persons operating a motor vehicle upon a bicycle lane or bicycle way shall yield the right-of-way to all bicycles within the bicycle lane or bicycle way.

346.95 Penalty for violating sections 346.87 to 346.94.

(1) Any person violating s. 346.87, 346.88, 346.89 (2), 346.90 to 346.92 or 346.94 (1), (9), (10), (11), (12) or (15) may be required to forfeit not less than \$20 nor more than \$40 for the first offense and not less than \$50 nor more than \$100 for the 2nd or subsequent conviction within a year.

347.489 Lamps and other equipment on bicycles and motor bicycles.

(1) No person may operate a bicycle or motor bicycle upon a highway, bicycle lane or bicycle way during hours of darkness unless the bicycle or motor bicycle is equipped with or the operator is wearing a lamp emitting a white light visible from a distance of at least 500 feet to the front of the bicycle or motor bicycle. A bicycle or motor bicycle shall also be equipped with a red reflector that has a diameter of at least 2 inches of surface area on the rear so mounted and maintained as to be visible from all distances from 50 to 500 feet to the rear when directly in front of lawful upper beams of headlamps on a motor vehicle. A lamp emitting a red light visible from a distance of 500 feet to the rear may be used in addition to but not in lieu of the red reflector.

(2) No person may operate a bicycle or motor bicycle upon a highway, bicycle lane or bicycle way unless it is equipped with a brake in good working condition, adequate to control the movement of and to stop the bicycle or motor bicycle whenever necessary.

(3) No bicycle or motor bicycle may be equipped with nor may any person riding upon a bicycle or motor bicycle use any siren or compression whistle.

347.50 Penalties.

(5) Any person violating s. 347.489 may be required to forfeit not more than \$20.

349.105 Authority to prohibit certain traffic on expressways and freeways. The authority in charge of maintenance of an expressway or freeway may, by order, ordinance or resolution, prohibit the use of such expressway or freeway by pedestrians, persons riding bicycles or other non-motorized traffic or by persons operating mopeds or motor bicycles. The state or local authority adopting any such prohibitory regulation shall erect and maintain official signs giving notice thereof on the expressway or freeway to which such prohibition applies.

349.18 Additional traffic-control authority of counties and municipalities.

(2)

(a) Except as provided in par. (b), any city, town or village may by ordinance regulate the operation of bicycles and motor bicycles and require registration of any bicycle or motor bicycle owned by a resident of the city, town or village, including the payment of a registration fee.

(b) A city, town or village may not prohibit the use of a bicycle equipped as provided in s. 346.79 (2) (b) to carry or transport a child in addition to the operator of the bicycle.

(3) Any county, by ordinance, may require the registration of any bicycle or motor bicycle owned by a resident of the county if the bicycle or motor bicycle is not subject to registration under sub. (2). Such ordinance does not apply to any bicycle or motor bicycle subject to registration under sub. (2), even if the effective date of the ordinance under sub. (2) is later than the effective date of the county ordinance. A county may charge a fee for the registration.

349.23 Authority to designate bicycle lanes and bicycle ways.

(1) The governing body of any city, town, village or county may by ordinance:

(a) Designate any roadway or portion thereof under its jurisdiction as a bicycle lane.

(b) Designate any sidewalk or portion thereof in its jurisdiction as a bicycle way.

(2) A governing body designating a sidewalk or portion thereof as a bicycle way or a highway or portion thereof as a bicycle lane under this section may:

(a) Designate the type and character of vehicles or other modes of travel which may be operated on a bicycle lane or bicycle way, provided that the operation of such vehicle or other mode of travel is not inconsistent with the safe use

and enjoyment, of the bicycle lane or bicycle way by bicycle traffic.

(b) Establish priority of right-of-way on the bicycle lane or bicycle way and otherwise regulate the use of the bicycle lane or bicycle way as it deems necessary. The designating governing body may, after public hearing, prohibit through traffic on any highway or portion thereof designated as a bicycle lane, except that through traffic may not be prohibited on any state highway. The designating governing body shall erect and maintain official signs giving notice of the regulations and priorities established under this paragraph, and shall mark all bicycle lanes and bicycle ways with appropriate signs.

(c) Paint lines or construct curbs or establish other physical separations to exclude the use of the bicycle lane or bicycle way by vehicles other than those specifically permitted to operate thereon.

(3) The governing body of any city, town, village or county may by ordinance prohibit the use of bicycles and motor bicycles on a roadway over which they have jurisdiction, after holding a public hearing on the proposal.

Appendix D

Bibliography

- AASHTO Maintenance Manual**, American Association of State Highway & Transportation Officials, 1987
- Americans with Disabilities Act**, U.S. Congress, 1990
- Americans with Disabilities Act Accessibility Guidelines**, U.S. Access Board, 2002
- Arizona Bicycle Facilities Planning & Design Guidelines**, Arizona DOT, 1988
- Bicycle Facilities Planning and Design Handbook**, Florida Department of Transportation, 2000
- Bicycle Transportation Plan for Madison Urban Area and Dane County**, Dane County Regional Planning Commission and Madison Department of Transportation, 2000
- California Highway Design Manual**, Ch. 1000, California DOT, 1995
- Facilities Development Manual**, Wisconsin DOT, 2001
- FHWA Guidance: Bicycle & Pedestrian Provisions of Federal Transportation Legislation**, Federal Highway Administration, 1999
- Guide for Development of Bicycle Facilities**, American Association of State Highway and Transportation Officials, 1999
- Guidelines for Developing Rural Bike Routes**, Wisconsin Departments of Transportation and Natural Resources, 1975
- Highway Design Manual, Sec. 1020**, Washington State Department of Transportation, 1989
- Manual on Uniform Traffic Control Devices**, FHWA, 2000
- Minnesota Bicycle Transportation Planning and Design Guidelines**, Minnesota Department of Transportation, 1996
- Montana Public Works Standard Specifications**, Montana Contractor's Association, 1988
- Mountain Bike Trails**, Techniques for Design, Construction and Maintenance, Bikecentennial, 1990
- North Carolina Bicycle Facilities Planning & Design Guidelines**, North Carolina DOT, 1996
- Oregon Bicycle and Pedestrian Plan**, Oregon Bikeway/Pedestrian Office, 1996
- Planning for Rural Bicycle Routes**, Van Valkenburg, Wisconsin DOT, 1993
- Policy on Geometric Design of Highways and Streets**, AASHTO, 2001
- Re-Evaluating Signal Detector Loops*, Alan Wachtel, NCBW Forum 2001
- Sign up for the Bike: Design Manual for a Cycle Friendly Infrastructure**, Centre for Research and Contract Standardization in Civil and Traffic Engineering, Netherlands, 1994
- Title 23 U.S.C. §217: Bicycle Transportation and Pedestrian Walkways**, Congress of the United States
- Traffic Calming - State of the Practice**, Institute of Transportation Engineers, 1999
- Trail Intersection Design Handbook**; Florida DOT, 1996
- Wisconsin Bicycle Transportation Plan 2020**, Wisconsin DOT, 1998

Index

Aggregate structural section, path	4-31	Railroad crossing angles and gaps	2-23
Arterial streets	2-4	Railroad crossing smoothness	2-26
Asphalt structural section, path	4-30	Railroad, crossings, path	2-26
Basic Roadway Improvements	2-1	Railroad crossings, roadway	2-23
Bicycle and bicyclist characteristics	1-2	Regulatory controls, path	4-38
Bicycle detection, signals	2-27	Residential streets	2-1
Bicycle lanes	3-1	Retrofitting wide outside lanes, roadway	2-15
Bicycle lane designation	3-14	Roadway types	2-1
Bicycle lane intersection design	3-18	Rumble strips, roadway	2-22
Bicycle lane location	3-3	Rural highways	2-5
Bicycle lane surface quality	3-8	Rural crossings, path	4-50
Bicycle lane width	3-9	Rural vs. urban/suburban locations, path	4-50
Bicycle Route Designation	2-45	Shared Use, path	4-83
Bridges, roadway	2-32	Shared-use paths	4-1
Bridges and overpasses, path	4-72	Shared-use paths and roadways	4-3
Collector streets	2-2	Shared-use paths in roadway medians	4-7
Concrete structural section, path	4-31	Shared-use path users, purposes, and locations	4-1
Corner sight lines	2-12	Shoulder pavement design and loading, roadway	2-21
Cross-country skiers, path	4-92	Shoulder width, roadway	2-18
Crossing design, path	4-55	Shoulders and clearances, path	4-9
Crossing locations, path	4-47	Sidewalk bikeways	4-6
Crossings - important features, path	4-67	Sight distance, path	4-19
Design options	1-5	Signal loop markings	2-29
Design Speed, path	4-11	Signal timing	2-30
Designing paths vs. roads	4-2	Signalized crossings, path	4-61
Drainage, path	4-34	Signalized parallel crossings, path	4-65
Drainage grates and utility covers, roadway	2-9	Signed parallel crossings, path	4-66
Foundation preparation, path	4-29	Signed crossings with traffic calming, path	4-59
Grade separations, path	4-69	Signing and marking, path	4-38
Grades, path	4-17	Sign placement, path	4-45
Grades, roadway	2-20	Sign sizes, path	4-46
Grate or utility cover elevation	2-11	Signs - using restraint, path	4-46
Grate or utility cover location	2-10	Simple signed crossing, path	4-56
Grate temporary measures	2-11	Snowmobiles, path	4-92
Grate type	2-9	Structures, path	4-71
Guardrails and slopes, shoulders	2-20	Structures, combined road/path	4-79
Horizontal alignment & superelevation, path	4-13	Structures, combined - separation	4-81
Horses, path	4-91	Structures, roadway	2-31
Informational signs, markings, path	4-42	Surface smoothness and maintenance, path	4-33
Interchanges, bike lane	3-24	Traffic calming, roadway	2-39
Interchanges, roadway	2-36	Traffic calming measures for slowing traffic, roadway	2-42
Intersections with right-turn lanes, bike lane	3-21	Traffic diversion approaches, roadway	2-40
Joints between travel lanes and shoulders	2-21	Traffic conditions & bridges, roadway	B-1
Left-turn, bicycle lane	3-23	Traffic signals	2-27
Lighting, path	4-35	Transitions between grades and level ground, path	4-18
Low-volume rural roads, shoulders	2-17	Underpasses and tunnels, path	4-75
Maintenance & Operations	A-1	Unpaved driveways, roadway	2-21
Motorbikes and motorcycles, path	4-86	Urban/suburban crossings, path	4-53
Motor vehicles, path	4-87	Vegetation Control, path	4-28
One-way vs. two-way bicycle lanes	3-2	Warning devices, path	4-41
Parallel crossings, path	4-63	Wide outside lanes	2-13
Path intersection: yes or no?	4-48	Wisconsin Statutes	C-1
Path-Roadway Crossings	4-47	Work zone controls, path	4-44
Paths in roadway medians	4-7	Width, path	4-7
Paths next to roadways, problems	4-3		
Paved shoulders, roadway	2-17		
Pavement quality, roadway	2-7		
Pavement loads, path	4-27		
Pavement structure, path	4-25		
Pedestrians and Bicyclists, path	4-83		
Programmed visibility heads, signals	2-30		

WISCONSIN BICYCLE FACILITY DESIGN HANDBOOK

Wisconsin Department of Transportation

2004