

Chapter H 63

PRIVATE SEWAGE SYSTEMS

- | | |
|---|---|
| H 63.01 Purpose (p. 277) | H 63.13 Installation—conventional soil absorption systems (p. 278-29) |
| H 63.02 Definitions (p. 278) | H 63.14 Pressure distribution systems (p. 278-31) |
| H 63.03 Approvals and limitations (p. 278-6) | H 63.15 Septic tanks and other treatment tanks (p. 278-42) |
| H 63.04 Specific limitations (p. 278-6) | H 63.16 Maintenance and sludge disposal (p. 278-46) |
| H 63.05 Local filing requirements (p. 278-8) | H 63.17 Chemical restoration (p. 278-46) |
| H 63.06 County administration (p. 278-9) | H 63.18 Holding tanks (p. 278-46) |
| H 63.07 Plan review—department (p. 278-11) | H 63.19 Inspection and tests (p. 278-49) |
| H 63.08 Examination of plans and specifications (p. 278-12) | H 63.20 Materials (p. 278-50) |
| H 63.09 Site evaluation (p. 278-14) | H 63.21 Building sewers and drains (p. 278-55) |
| H 63.10 Site requirements (p. 278-21) | H 63.22 Alternative private sewage systems (p. 278-55) |
| H 63.11 Initial adverse determination (p. 278-25) | H 63.23 Mound systems (p. 278-58) |
| H 63.12 Sizing soil absorption systems (p. 278-25) | H 63.24 Severability (p. 278-77) |
| | Appendix (p. 278-78) |

Note: Chapter H 63 was created as an emergency rule effective 6-21-80, *not near from H 62-70*

H 63.01 Purpose. (1) **GENERAL.** The underlying principles of this chapter as authorized in s. 145.02 (2), Stats., are basic goals in environmental health and safety accomplished by proper siting, design, installation, inspection, and maintenance of private sewage systems. The prerequisites necessary for the essential protection of the health of the public and the environment are the same everywhere. As unforeseen situations arise which are not specifically covered in this chapter the basic principles enumerated in this section shall serve to define intent.

(2) **BASIC PRINCIPLES.** (a) **Need.** Every building intended for human habitation or occupancy shall be provided with a properly functioning system for treatment and disposal of domestic waste.

(b) **Public sewers.** Every building intended for human habitation or occupancy on land abutting a street, right-of-way, or easement in which there is a public sewer, or on land deemed accessible to public sewer, shall have an individual connection to the public sewer and the private sewage system serving such building shall be properly abandoned.

(c) **Discharges prohibited.** Every private sewage system shall be designed, located and constructed to prevent any discharge of sewage or partially treated sewage into drain tiles, onto the ground surface, into the structure served, into the surface waters of the state or into the groundwater of the state including zones of seasonal soil saturation.

(d) **Maintenance.** Every private sewage system shall be adequately maintained.

(e) **Nuisance.** Every private sewage system shall be designed, located and constructed so as not to create a nuisance.

(f) *Sizing*. Every private sewage system shall be designed and constructed to adequately dispose of all the wastewater generated in the structure or facility it is serving.

History: Cr. Register, December, 1980, No. 300, eff. 1-1-81.

H 63.02 Definitions. For the purpose of this chapter, the following definitions shall apply. The dictionary meaning shall apply for all other words.

(1) "Aggregate" means washed graded hard rock that has been washed with water under pressure over a screen during or after grading to remove fine material and with a hardness value of 3 or greater on Moh's Scale of Hardness. Aggregate that can scratch a copper penny without leaving any residual rock material on the coin would have a hardness of 3 or more on Moh's Scale of Hardness.

(2) "Alternative private sewage system" means a system as defined in s. 145.022 (1) (a), Stats. The alternative private sewage systems included in this chapter, but not limited by enumeration, are mound systems and shallow sub-surface pressure distribution systems used on sites not meeting the soil criteria for conventional private sewage systems.

(3) "Approved" means approved or accepted by the department.

(4) "Bedrock" means the rocks that underly soil material or are at the earth's surface. Bedrock is encountered when the weathered in-place consolidated material, larger than 2 mm in size, is greater than 50% by volume.

(5) "Building" means a structure having walls and a roof erected or set upon an individual foundation or slab-constructed base designed or used for the housing, shelter, enclosure or support of persons, animals or property of any kind. A mobile home is included in this definition. Each structure abutting another structure which does not have an ingress-egress doorway through the basement foundation walls, or structures with separate exterior or exterior abutting walls, or public use structures separated by an unpierced firewall, shall be considered as a separate or individual building.

(6) "Cesspool" means a covered excavation in the ground which receives sewage or other organic wastes from a drainage system, and so designed as to retain the organic matter and solids, permitting the liquids to seep into the soil cavities.

(7) "Cleanout" means a plug or cover made of material approved by the department joined by means of a screw thread to an opening in a pipe, which can be removed for the purpose of cleaning or examining the interior of the pipe.

(8) "Clear water wastes" means cooling water and condensate drainage from refrigeration compressors and air-conditioning equipment, water used for equipment chilling purposes, liquid having no impurities or where impurities have been reduced below a minimum concentration considered harmful, and cooled condensate from steam heating systems or other equipment.

(9) "Color" means the moist color of the soil based on Munsell soil color charts.

(10) "Conventional private sewage system" means a system as defined in s. 145.022 (1) (b), Stats. Conventional private sewage systems included in this chapter are systems using a conventional soil absorption system, a system installed in a filled area approved in writing by the department, and a dosing soil absorption system.

(11) "Conventional soil absorption system" means a system that employs gravity flow from the septic or other treatment tank and applies effluent to the soil through the use of a seepage trench, bed or pit. The distribution piping is 4 inch diameter pipe.

(12) "County" means the local government unit responsible for the regulation of private sewage systems. County government is the local governmental unit responsible except that towns, villages and cities are the responsible unit of government in any county that has a population in excess of 500,000.

(13) "Department" means the department of industry, labor and human relations.

(14) "Detailed soil map" means a map prepared by or for a state or federal agency participating in the national cooperative soil survey showing soil series, type and phases at a scale of not more than 2,000 feet to the inch and includes related explanatory information.

(15) "Dosing soil absorption system" means a system that employs a pump or automatic siphon to elevate or distribute effluent to the soil through the use of a seepage trench or bed. Distribution piping in seepage trenches or beds shall be 4 inch perforated pipe approved by the department.

(16) "Dwelling unit" means one or more rooms with provisions for living, sanitary and sleeping facilities which are used or intended to be used by one person or by 2 or more persons maintaining a common household.

(17) "Effluent" means liquid discharged from a septic or other treatment tank.

(18) Failing private sewage system is defined in s. 144.24 (10) (d), Stats., as follows: "A failing private sewage system is one which causes or results in any of the following conditions:

1. The failure to accept sewage discharges and back up of sewage into the structure served by the private sewage system.
2. The discharge of sewage to the surface of the ground or to a drain tile.
3. The discharge of sewage to any waters of the state.
4. The introduction of sewage into zones of saturation which adversely affects the operation of a private sewage system."

(19) "Farm" means a parcel of 35 or more acres of contiguous land which is devoted primarily to agricultural use, as defined in s. 91.01 (1) and (5), Stats., which during the year preceeding application for a mound produced gross farm profits as defined in s. 91.09 (11) (a) 3m, Stats., of not less than \$6,000 or which during the 3 years preceeding

application produced gross farm profits, as defined in s. 91.09 (11) (a) 3m, Stats., of not less than \$18,000.

(20) "Flood fringe" means that portion of a flood plain which is outside of the floodway and which is covered by flood waters during any regional floods. It is generally associated with standing water rather than rapidly flowing water.

(21) "Flood plain" means the land which has been or may be covered by flood water during regional floods. The flood plain includes the floodway and the flood fringe.

(22) "Floodway" means the channel of a river or stream and those portions of the flood plain adjoining the channel which carry and discharge flood water or flood flows during the regional floods.

(23) "Grease interceptor" means a watertight tank which is installed underground for the collection and retention of grease from cooking or food processing and which is accessible for periodic removal of the contents.

(24) "High groundwater" means zones of soil saturation which include: Perched water tables, shallow regional groundwater tables or aquifers, or zones that are seasonally, periodically or permanently saturated.

(25) "High water level" means the highest known flood water elevation of any lake, stream, pond or flowage or the regional flood elevation established by a state or federal agency.

(26) "Holding tank" means an approved watertight receptacle for the collection and holding of sewage.

(27) "Horizontal reference point" means a stationary, easily identifiable point to which horizontal dimensions can be related.

(28) "Industrial waste" means liquid wastes which result from processes employed in industrial establishments.

(29) "Legal description" means an accurate Metes and Bounds description, a lot and block number in a recorded subdivision, a recorded assessor's plat or a public land survey description to the nearest 40 acres.

(30) "Manhole" means an opening of sufficient size to permit a person to gain access to a sewer or any portion of a plumbing system.

(31) "Mobile home" means a transportable structure mounted on a chassis and designed to be used with or without a permanent foundation as a dwelling unit. The phrase "without a permanent foundation" indicates that the support system is constructed with the intent that the mobile home thereon may be moved from time to time at the convenience of the owner. See s. 218.10 (2) and 340.01 (29), Stats.

(32) "Mobile home park" means any plot or plots of ground owned by a person, state or local government upon which 2 or more units, occupied for dwelling or sleeping purposes regardless of mobile home ownership, are located, and whether or not a charge is made for such accommodation. See s. 66.058 (1) (i), Stats.

(33) "Nuisance" means any source of filth, odor or probable cause of sickness pursuant to the provisions of s. 146.14, Stats.

(34) "Percolation test" means the method specified in s. H 63.09 (5) of testing absorption qualities of the soil.

(35) "Permeability" means the ease with which liquids move through the soil. One of the soil qualities listed in soil survey reports.

(36) "Pipe diameters" means the inside diameter.

(37) "Plumbing system" means a system as defined in s. 145.01 (1), Stats.

(38) "Potable water" means water which is satisfactory for human consumption, hygiene and culinary use and meets the requirements of the state administrative authority having jurisdiction.

(39) "Pressure distribution system" means a soil absorption system that employs a pump or automatic siphon and small diameter distribution piping with small diameter perforations to introduce effluent into the soil. Plan review and departmental approval is required for each system of this type.

(40) Private sewage system is defined in s. 145.01 (14), Stats.

(41) "Private residence" means a one or 2 family building or dwelling. See dwelling unit.

(41) "Privy" means a structure that is not connected to a plumbing system which is used by persons for the deposition of human body wastes.

(43) "Public building" means any structure, including exterior parts of such building, such as a porch, exterior platform or steps providing means of ingress or egress, used in whole or in part as a place of resort, assemblage, lodging, trade, traffic, occupancy or use by the public, or by 3 or more tenants in accord with s. 101.01 (2) (h), Stats.

(44) "Reservoir" means a watertight receptacle basin or vault constructed above the ground surface or underground for the storage of potable water.

(45) "Public garage" means a building or part of a building used for the storage of land, air or water vehicles by 3 or more persons not of the same family or habitation.

(46) "Regional flood" means as defined in ch. NR 116, Wis. Adm. Code.

(47) "Regional flood elevation" means as defined in ch. NR 116, Wis. Adm. Code.

(48) "Seepage bed" means an excavated area larger than 5 feet in width which contains a bedding of aggregate and has more than one distribution line.

(49) "Seepage pit" means an underground receptacle so constructed as to permit disposal of effluent or clear wastes by soil absorption through its floor and walls.

(50) "Seepage trench" means an area excavated one to 5 feet in width which contains a bedding of aggregate and a single distribution line.

(51) "Septic tank" means a tank which receives and partially treats sewage through processes of sedimentation, oxygenation, flotation and bacterial action so as to separate solids from the liquid in the sewage and discharges the liquid to a soil absorption system.

(52) "Sewage" means the liquid and water carried wastes created in and to be conducted away from residences, industrial establishments and public buildings.

(53) "Soil" means the unconsolidated material over bedrock.

(54) "Soil boring" means an observation pit dug by hand or backhoe, a hole dug by augering or a soil core taken intact and undisturbed with a probe.

(55) "Soil mottles" means spots or streaks of contrasting soil colors usually caused by soil saturation for some period of a normal year.

Note: Grayish colored mottles are called low chroma; reddish brown, red or yellow mottles are called high chroma.

(56) "Soil saturation" means the state when all the pores in a soil are filled with water. Water will flow from saturated soil into a bore hole.

(57) "Topsoil" means the undisturbed surface horizon of a soil often characterized by a black or dark grayish brown color due to a higher content of organic matter.

(58) "Vent cap" means an approved appurtenance used for covering the vent terminal of an effluent disposal system to avoid closure by mischief or debris and still permit circulation of air within the system.

(59) "Vertical elevation reference point" means an easily identifiable stationary point or object of constant elevation for establishing the relative elevation of percolation tests, soil borings and other locations.

(60) "Water service" means a pipe extended from the water main or private pumping system or other supply source with or without lateral extensions to the building, structure or other system to be served.

(61) "Workmanship" means work of such character that will fully secure the results sought in all the sections of this chapter as intended for the safety, welfare and health protection of all individuals.

(62) "Watercourse" means a stream usually flowing in a particular direction, though it need not flow continually, it may sometimes be dry. It must flow in a definite channel, having a bed, sides or banks, and usually discharges itself into some other stream or body of water. It must be something more than a mere surface drainage over the entire face of a tract of land, occasioned by unusual freshets or other extraordinary causes. It does not include the water flowing in the hollows or ravines in land, which is the mere surface water from rains or melting snow, and is discharged through them from a higher to a lower level, but which at other times are destitute of water. Such hollows or ravines are not in legal contemplation watercourses. (*Hoyt vs. City of Hudson* 27 Wis. 656 (1871), Wisconsin Supreme Court)

(63) MISCELLANEOUS. Standards or Specifications Abbreviations.

A.G.A.....	American Gas Association, Inc. 420 Lexington Ave., New York, New York 10017
A.N.S.I.	American National Standards Institute, Inc. 1430 Broadway, New York, New York 10018
A.S.M.E.	American Society of Mechanical Engineers 29 W. 39th St., New York, New York 10018
A.S.S.E.....	American Society of Sanitary Engineering 960 Illuminating Building, Cleveland, Ohio 44113
A.S.T.M.	American Society for Testing and Material 1916 Race St., Philadelphia, Pa. 19103
A.W.W.A.....	American Water Works Association 2 Park Avenue, New York, New York 10016
C.S.	Commercial Standards, Supt. of Documents Governmental Printing Office, Washington, D. C. 20401
F.S.	Federal Specifications General Services Administration, Regional Office 3, Washington, D.C. 20407
M.S.S.....	Manufacturers Standardization Society of the Value and Fittings Industry 420 Lexington Ave., New York, New York 10017
N.S.F.	National Sanitation Foundation Testing Laboratory, Inc., P.O. Box 1468 Ann Arbor, Michigan 48106
U.L.....	Underwriters' Laboratories, Inc. 207 E. Ohio Street, Chicago, Illinois 60611
W.C.F.....	Water Conditioning Foundation 1201 Waukegan Road, Glenview, Illinois 60025

Note: For definitions of master plumber, journeyman, restricted plumbers, apprentices, registered learners and certified soil tester, refer to ch. 145, Stats.

History: Cr. Register, December, 1980, No. 300, eff. 1-1-81.

H 63.03 Approvals and limitations. (1) **ALLOWABLE USE.** Septic tank and effluent absorption systems or other treatment tank and effluent disposal systems as may be approved by the department may be constructed when no public sewerage system is available to the property to be served. Unless specifically approved by the department, the private sewage system of each building shall be entirely separate from and independent of that of any other building. A private sewage system may be owned by the property owner or by a special purpose district. The use of a common system or a system on a different parcel than the structure will be subject to the same plan review procedures as for systems serving public buildings.

(2) **PUBLIC SEWER CONNECTION.** When public sewers approved by the department of natural resources become available to the premises served, the use of the private sewage system shall be discontinued within that period of time required by order, but not to exceed one year. The building sewer shall be disconnected from the private sewage system and be connected to the public sewer. All abandoned treatment tanks and seepage pits shall have the contents pumped and disposed of in accordance with ch. NR 113, Wis. Adm. Code. The top or entire tank shall be removed and the remaining portion of the tank or excavation shall be immediately filled with suitable soil material.

(3) **FAILING SYSTEM.** When a failing or malfunctioning private sewage system is encountered, the sewage disposal system shall be corrected or its use discontinued within that period of time required by county or departmental order, with a maximum time limit of one year.

History: Cr. Register, December, 1980, No. 300, eff. 1-1-81.

H 63.04 Specific limitations. (1) **DOMESTIC WASTE.** All water carried wastes derived from ordinary living uses shall enter the septic or treatment tank unless otherwise specifically exempted by the department or this chapter.

(2) **CESPOOLS.** Cesspools are prohibited.

(3) **INDUSTRIAL WASTES.** The department of natural resources shall be contacted in regard to the treatment and disposal of all industrial wastes including those combined with domestic waste.

(4) **CLEAR WATER.** The discharge of surface, rain and other clear water into a private sewage system is prohibited.

(5) **WATER SOFTENER AND IRON FILTER BACKWASH.** Water softener or iron filter discharge may be directed to the private sewage system, or to the ground surface if a nuisance is not created.

(6) **FLOODPLAIN.** (a) *General.* A soil absorption system shall not be installed in a floodway. Soil absorption systems in the flood fringe shall not be installed unless written approval is received from the department. The department shall receive written approval from the local government and the department of natural resources for construction in, and filling of, the floodplain area prior to reviewing and approving plans.

(b) *New developments.* 1. **Floodway.** New private sewage systems shall not be installed in a floodway.

2. **Flood fringe.** In the flood fringe the installation of individual private sewage systems will be reviewed on a case-by-case basis. It is prefer-

able that with new systems that are allowed in "fringe" areas they be installed on land contiguous to land outside the flood plain limit. However, developments in isolated areas within the flood fringe may also be approved. Land areas shall be filled and thus removed from the flood plain designation. The amount of area to be filled is site dependent and will be evaluated on a site-by-site basis. Individual sites shall be checked by the county and may be checked by department staff to insure that soil conditions and other factors are in full accord with ch. NR 116, Wis. Adm. Code. The requirements of this chapter must be met before any placement of fill is authorized to overcome specific flooding conditions. The filled area for the building and the filled area for the private sewage system shall be connected. The extent and design of the fill for the sewage disposal system shall be in accord with the current rules of the department for systems in fill. [See s. H 63.10 (6).] The department of natural resources will determine whether an island within a river is located in a flood plain and if it is subject to flood plain regulations.

(c) *Existing developments.* 1. Floodway. The following types of replacement systems may be allowed on a case-by-case basis to abate a health hazard in floodway areas:

a. Holding tanks that are flood-proofed in accordance with county and state flood plain standards. [See s. H 63.18 (8)]

b. The installation of a replacement soil absorption system outside the flood plain limit connected to the development by a force main or to an approved acceptable site outside the floodway but in the flood fringe area. Septic tanks in the floodway shall be flood-proofed. The site must meet the requirements set forth in this chapter.

2. Flood fringe. Malfunctioning soil absorption systems may generally be replaced provided favorable soil conditions and other site factors exist.

a. County approval and acceptance shall be documented on plumbing form PLB 89 prior to state approval.

b. If filling is necessary and upon receipt of county approval, the specific design criteria and fill conditions will be stipulated for each installation in accord with this chapter.

Note: Soil absorption systems are preferable to holding tanks.

3. Processing of form PLB 89. Form PLB 89 serves as the basis for department approval of sewage disposal systems in flood plain areas. A copy of this form signed by the local authority will be submitted to the department of natural resources by the department. The county authority's signature is mandatory. Approval of a new or replacement system by the department of natural resources or the department will not be granted if the form is unsigned. The department of natural resources' approval indicated by signing form PLB 89 relates only to the accuracy of the flood plain data.

(d) *Special flood plain developments.* In certain flood plain areas where the installation of sewage disposal systems may be necessary but because of unique site conditions cannot comply with ch. NR 116, Wis. Adm. Code, or this chapter, the department of natural resources may authorize or approve special flood plain developments provided they are in accord with the purpose and intent of ch. NR 116, Wis. Adm. Code,

and county flood plain ordinances. Special developments may include but not be limited to such projects as campgrounds in flood plain areas, or the expansion of certain nonconforming uses.

History: Cr. Register, December, 1980, No. 300, eff. 1-1-81.

H 63.05 Local filing requirements. (1) **SOIL TEST REPORTS.** The county shall establish a filing system for soil test reports. The county shall review soil test reports for proposed private sewage disposal systems and verify the data reported if necessary. If the soil test report is considered to be adequate, the county shall file the report.

(2) **COUNTY PLAN EXAMINATION FOR ONE AND 2 FAMILY RESIDENCES.** (a) *General.* Complete plans and specifications shall be submitted to the county with the application for sanitary permit. Plans shall be submitted on paper not less than 8½ by 11 inches in size. The county may set the number of plan copies required to adequately review the application for the sanitary permit and for the inspection of the private sewage system installation.

(b) *Plans and specifications.* All plans shall include the following:

1. Plot plan. Detailed plot plan dimensioned or drawn to scale showing the lot size; the location of all septic tanks; holding tanks or other treatment tanks; building sewers—sanitary and storm; wells; water mains or water service; streams and lakes; dosing or pumping chambers; distribution boxes; effluent systems; dual disposal systems; replacement system areas; and the location of the building served. Adjoining properties shall be checked to insure that the site location distances in s. H 63.10 (1) are complied with. All separating distances and dimensions shall be shown on the detailed plot plan.

2. Reference points. A vertical elevation reference point and a horizontal reference point.

3. Soil data. Soil boring and percolation test data related to the undisturbed and finished grade elevations, vertical elevation reference point and horizontal reference point. Surface elevations shall be given for all soil borings.

4. Occupancy. The maximum number of bedrooms in the residence shall be indicated.

5. Other specifications. Complete specifications for pumps and controls including dose volume, elevation differences (vertical lift), pipe friction loss, pump performance curve, pump model and pump manufacturer.

(3) **FEEES.** The county may require plan examination fees or include these fees in the cost of the sanitary permit in accord with s. 145.19 (2), Stats.

(4) **REVISED PLANS.** Every installer of a private sewage system who modifies or changes the design of a system must submit to the county authority a revised plan. All changes or modifications must be approved by the county authority prior to installation.

(5) **ACCEPTANCE.** No private sewage system shall be used until the proper sanitary permit, inspection and a revised plan, if required, has been accepted and filed by the county authority.

(6) **PLAN FILING.** The county shall establish a filing system which provides a system of retrieval of sanitary permits and plans and may set by ordinance a filing fee. The county may require that additional information be included on the plan to aid in filing, indexing or retrieving permits and plans.

History: Cr. Register, December, 1980, No. 300, eff. 1-1-81.

H 63.06 County administration. (1) **PRIVATE SEWAGE SYSTEM ORDINANCE.** (a) *Adoption of ordinance.* Every county shall adopt an ordinance governing private sewage systems which conforms with this chapter. The ordinance shall apply to the entire area of the county. (Ref. s. 59.065 (1), Stats.)

(b) *Enforcement.* The county shall administer the private sewage system ordinance in accordance with s. 145.20, Stats., and this chapter.

(2) **SANITARY PERMITS.** (a) *General.* The county shall establish administrative procedures for the approval, disapproval or issuance of state sanitary permits in accord with s. 145.135, and s. 145.19, Stats., and this chapter.

(b) *Application.* The application for a sanitary permit shall be made on forms furnished by the department. Before a private sewage system is installed a licensed master plumber or master restricted plumber (sewer) shall sign the application for permit and assume responsibility for installation of the system. (Ref. s. 145.06 and s. 145.135, Stats.)

(c) *Permit transfer.* When there is a change of ownership, building use or master plumber, a permit transfer form furnished by the department shall be submitted to the county for approval prior to the installation of a private sewage system. Failure to submit transfer forms to the county shall invalidate the sanitary permit in accord with s. 145.135 (1), Stats. The county may charge a fee for the transfer of a sanitary permit.

(d) *Posting.* The sanitary permit shall be issued by the county on forms furnished by the department. The sanitary permit shall be displayed conspicuously so as to be visible from the road fronting the lot during construction.

(3) **COUNTY ORGANIZATION AND PERSONNEL.** (a) *Assignment of duties.* The county board may assign the duties of administering the private sewage system program to any county office, department, committee, board, commission, position or employe.

(b) *Certified soil tester.* The county shall obtain the services of a certified soil tester, either as a county employe or under contract, to review and verify certified soil tester reports.

(4) **COUNTY RESPONSIBILITIES.** (a) *Review of soil test reports.* The county shall review certified soil tester reports for proposed private sewage systems and verify the report at the proposed site, if necessary.

(b) *Review of applications for sanitary permits.* The county shall approve or disapprove applications for sanitary permits and assist applicants in preparing an approvable application. (See s. H 63.11.)

(c) *Written notice.* The county shall issue written notice to each applicant whose sanitary permit application is disapproved. Each notice shall state the specific reasons for disapproval and amendments to the application, if any, which render the application approvable. Each notice shall also give notice of the applicant's right to appeal and the procedures for conducting an appeal under ch. 68, Stats.

(d) *Inspections.* The county shall inspect all private sewage systems after construction but before backfilling no later than the end of the next workday, excluding Saturdays, Sundays and holidays, after receiving notice from the plumber in charge. Inspections shall be reported on forms furnished by the department.

(e) *Reports and surveys.* The county shall file reports and conduct surveys and inspections as required by the county or the department.

(f) *Investigate violations.* The county shall investigate violations of the private sewage system ordinance and s. 146.13, Stats., issue orders to abate the violations and submit orders to the district attorney, corporation counsel or attorney general for enforcement.

(g) *Other duties.* The county shall perform other duties regarding private sewage systems as considered appropriate by the county or as required by the rules of the department.

(5) DEPARTMENT RESPONSIBILITIES. (a) *Department approval.* The department may specify categories of private sewage systems for which approval by the department is required prior to issuance of sanitary permits by the county.

(b) *Department audit.* The department shall review the private sewage system program in each county to ascertain compliance with s. 145.20 (2), Stats., and with rules promulgated by the department. This review shall include a random audit of sanitary permits, including verification by on-site inspection.

(c) *Compliance.* If a county board does not adopt a private sewage system ordinance meeting the requirements of s. 59.065, Stats., or if the county does not appoint personnel meeting the requirements of s. 145.20 (1), Stats., or if the county does not comply with the requirements of s. 145.20 (2), Stats., the department may conduct hearings in the county seat upon 30 days notice to the county clerk. As soon as practicable after the public hearing, the department shall issue a written decision regarding compliance with s. 59.065 or s. 145.20 (1) (2), Stats. If the department determines that there is a violation of these provisions, the county may not issue a sanitary permit for the installation of a private sewage system until the violation is corrected.

(d) TRAINING. The department shall conduct training and informational programs for county officials and employes and persons licensed under this chapter and s. 146.20, Stats., to improve the delivery of service under the county private sewage system program. The department shall obtain the assistance of the Wisconsin county boards association in planning and conducting the training and informational programs.

Note: H 63.06 (3) to (5) is quoted directly from ch. 145, Stats.

History: Cr. Register, December, 1980, No. 300, eff. 1-1-81.

Register, December, 1980, No. 300.

H 63.07 Plan review—department. (1) **APPROVALS.** (a) *One and 2 family residences.* Unless required elsewhere in this chapter, the submission of plans and specifications and departmental approval of initial, modified, additional or replacement construction of private sewage systems serving one and 2 family residences is not required. All applicable plans, permits and approvals required by county government shall be obtained prior to the commencing of construction. The county government shall require plans and specifications prior to issuing permits or approval. [See s. H 63.05 (2).]

(b) *Public buildings—department approval.* Complete plans and specifications shall be submitted in accord with this section. Written approval shall be received before sanitary permits are issued for the initial installation of a private sewage system or for the addition to, modification or replacement of the system, if the system serves or will serve any public buildings. The owner shall submit a copy of the approved plans to the county authority. Included as public buildings but not limited by enumeration are: Theaters and assembly halls; schools and other places of instruction; apartment buildings, hotels and places of detention; factories, office and mercantile buildings; mobile home parks, campgrounds and camping resorts and parks.

(c) *Public buildings—local approval.* Approval by the county shall not eliminate the need for approval by the department for the installation of private sewage systems serving public buildings. Departmental approval shall not eliminate the need for obtaining all required county permits and approvals.

(2) **SUBMISSION OF PLANS AND SPECIFICATIONS—PUBLIC BUILDINGS.** All plans and specifications shall be submitted in duplicate and shall include the following:

(a) *PLOT PLAN.* Detailed plot plan dimensioned or drawn to scale showing the lot size; the location of all septic tanks, holding tanks or other treatment tanks, building sewers—sanitary and storm, wells, water mains or water service, streams and lakes, dosing or pumping chambers, distribution boxes, effluent disposal systems, dual disposal systems, and disposal replacement areas; and the location of the public building served by such systems. Adjoining properties shall be checked to insure that the site location distances in s. H 63.10 (1) are complied with. All distances and dimensions shall be shown on the detailed plot plan;

(b) *Legal description.* Legal description of the property on which the system is to be installed;

(c) *Reference points.* A vertical elevation reference point and a horizontal reference point;

(d) *Soil data.* Soil boring and percolation test data related to the undisturbed and finished grade elevations and vertical elevation reference point and horizontal reference point;

(e) *Contours—original grade.* Ground slope with 2-foot contours for the original, undisturbed grade elevation of the entire area of the soil absorption system and the area on all sides for a distance of 25 feet;

(f) *Contours—altered sites.* Ground slope with 2-foot contours for the grade elevation of the entire area of the soil absorption system and

the area on all sides for a distance of 25 feet after alteration of the landscape;

(g) *Use and occupancy.* Complete data relative to the maximum expected use and occupancy of the building to be served considering all anticipated future growth plans;

(h) *Other specifications.* Complete specifications for pumps and controls including dose volume, elevation differences (vertical lift), friction loss, pump performance curve, pump model and pump manufacturer.

(3) **PLAN EXAMINATION FEE.** All plans and specifications submitted to the department for review shall be accompanied with fees as established in s. H 63.08.

(4) **PLAN REVISIONS.** Revisions to approved plans and specifications shall be approved by the department.

(5) **PLAN AVAILABILITY.** One set of plans bearing the department's stamp of approval shall be maintained at the project site during construction of any private sewage system serving a public building.

History: Cr. Register, December, 1980, No. 300, eff. 1-1-81.

H 63.08 Examination of plans and specifications. (1) **PLAN EXAMINATION REQUIRED.** Plans and specifications for private sewage systems serving public buildings, or use of experimental or alternate type systems, or a variance to this chapter and holding tanks shall be submitted to the department and written approval received before county sanitary permits are issued or work commences. The department shall immediately acknowledge receipt of all plans and specifications. The department may issue a permit to commence work provided plan review is not completed within 30 days. The issuance of a county permit shall not be construed as plan approval or as approval for any design or installation that is noncompliant. All noncode complying portions of the plumbing and private sewage system installed prior to complete plan review shall be removed.

(2) **PLAN SUBMISSION.** (a) **STAMPING AND SIGNING PLANS.** All plans and specifications shall be sealed or stamped in accord with ch. A-E 1, Wis. Adm. Code by a registered architect, engineer or registered plumbing designer. A master plumber may design and submit for approval plumbing plans and specifications for a private sewage system which they are to install. Each sheet of plans and specifications the master plumber submits shall be signed, dated and include their Wisconsin master plumber license number. When more than one sheet is bound together into one volume, only the title sheet or index sheet need be signed and dated by the master plumber responsible for their preparation, provided the signed sheet clearly identifies all of the other sheets comprising the bound volume.

(b) *Submitting data.* All plans, preliminary or complete, shall be submitted in duplicate. Work shall not commence until written approval for the preliminary or complete plans is received from the department. The plans submitted shall be prints that are clear, legible and permanent. All pertinent data shall be a part of or shall accompany all plans submitted for review. Plans will be examined in the order of receipt.

(c) *Additions and alterations.* This section shall apply to all additions, alterations and modifications as well as to all new private sewage systems and shall apply to all cases where there is a change of the type of occupancy or use of building which requires changes to or intended use of the plumbing or private sewage system so as to comply with this chapter for that occupancy or use.

(d) *Agent municipalities.* The department may designate counties as agents for the review of plans and specifications for private sewage systems serving public buildings. All requests for variances to the code or experimental or alternative private sewage system designs shall be submitted to the department for review.

(3) **PLAN EXAMINATION FEES.** Fees shall be charged in accordance with s. Ind 69.23 (2), Wis. Adm. Code.

(4) **REVISIONS.** After written approval is granted, plans and specifications of plumbing systems shall not be changed without written consent of the department and the architect, engineer, designer or master plumber responsible for the design.

(5) **LIMITATIONS.** In granting approval of plans, specifications, products, devices or materials, the department is not liable for any defects in construction, nor for any damages that may result from the specific installation.

(6) **PLAN AVAILABILITY.** The architect, professional engineer, registered designer, owner or plumbing contractor shall keep at the construction site one set of plans bearing the stamp of approval of the department.

History: Cr. Register, December, 1980, No. 300, eff. 1-1-81; r. and recr. (3), Register, June, 1982, No. 318, eff. 7-1-82.

H 63.09 Site evaluation. (1) **GENERAL.** Site evaluation shall be conducted by a soil tester certified by the department in accord with ch. H 64, Wis. Adm. Code. The evaluation shall include soil conditions, properties and permeability, depth to zones of soil saturation, depth to bedrock, slope, landscape position, all setback requirements and the potential for flooding. Soil test data shall relate to the undisturbed elevations and a vertical elevation reference point or benchmark must be established. Evaluation data shall be reported on forms provided by the department and signed by the certified soil tester. Reports shall be filed for all sites investigated within 30 days of the completion of testing.

(2) **REPLACEMENT SYSTEM AREA.** (a) *General.* On each parcel of land being initially developed, sufficient area of suitable soils, based on the soil tests and system location and site requirements contained in this chapter, for one replacement system shall be established. Where bore hole test data in the replacement system area are equivalent to that in the proposed system area, the percolation test may be eliminated.

(b) *Non-conforming site conditions.* The department shall be contacted for approval of replacement systems for all public buildings and all buildings where site conditions do not permit systems in accord with this chapter. Alternates for the disposal of effluents emanating from existing structures may be accomplished by means other than those outlined in this chapter provided written local approval is obtained and submitted along with detailed plans and specifications to the depart-

ment for review and consideration. Written approval shall be received from the department prior to the county issuing permits or work commences on these systems.

(c) **UNDISTURBED SITE.** The replacement system area shall not be disturbed to the extent that it is no longer a suitable system area. The replacement system area shall not be used for the following:

1. Construction of buildings
2. Parking lots or parking areas

3. Below ground swimming pools

4. Any other use that may adversely affect the replacement area.

(3) **SLOPE.** (a) *General.* A conventional soil absorption system shall not be located on a land slope of greater than 20%. A conventional soil absorption system shall be located at least 20 feet from the crown of a land slope that is greater than 20% except where the top of the aggregate of a system is at or below the bottom of an adjacent roadside ditch.

(b) *Specific system designs.* Where a more restrictive land slope is to be observed for a soil absorption system other than a conventional system, the more restrictive land slope specified in the design sections of this chapter shall apply.

(4) **SOIL BORINGS AND PROFILE DESCRIPTIONS.** (a) *General.* Soil borings shall be conducted on all sites regardless of the type of private sewage system planned to serve the parcel. Borings shall extend at least 3 feet below the bottom of the proposed system. Borings shall be of sufficient size and extent to determine the soil characteristics important to on-site liquid waste disposal. Borehole data shall be used to determine the suitability of the soils at the site with respect to zones of seasonal or permanent soil saturation, and the depth to bedrock. Borings shall be conducted prior to percolation tests to determine whether the soils are suitable to warrant percolation tests and if suitable, at what depth percolation tests shall be conducted. The use of power augers for soil borings is prohibited.

Note: Backhoe borings are preferable to borings augered or dug by hand.

(b) *Number.* There shall be a minimum of 3 suitable borings per soil absorption site. More soil borings may be necessary for accurate evaluation of a site.

1. *Depth of borings.* Borings shall be constructed to a depth of at least 3 feet below the proposed depth of the system.

2. *Exceptions.* On new parcels, the requirement of 6 borings (3 for initial area and 3 for replacement area) may be reduced to 5 if the initial and replacement system areas are contiguous and one boring is made on each outer corner of the contiguous area and the fifth boring is made between the system areas. See diagram.

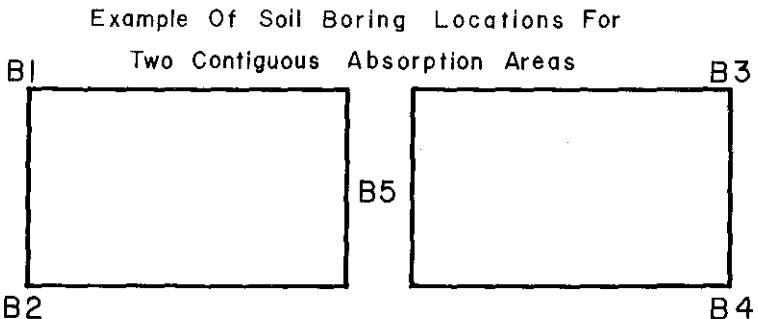

3. Reports. Regardless of the number of borings evaluated and conditions observed in borings, all soil information derived from borings shall be reported.

4. Location. Each borehole location shall be accurately located and referenced to the vertical elevation and horizontal reference point. Reports of boring locations shall either be drawn to scale, or have the horizontal dimensions clearly indicated between the borings and the horizontal reference point.

(c) *Soil description.* Soil profile descriptions shall be written for all borings. The thickness in inches of the different soil horizons observed shall be indicated. Horizons shall be differentiated on the basis of color, texture, soil mottles or bedrock. Depths shall be measured from the ground surface.

(d) *Soil mottles.* Zones of seasonal or periodic soil saturation shall be estimated at the highest level of soil mottles. The county or department may require a detailed description of the soil mottling on a marginal site. The abundance, size, contrast and color of the soil mottles should be described in the following manner.

1. Abundance. Abundance shall be described as few if the mottled color occupies less than 2% of the exposed surface; common if the mottled color occupies from 2 to 20% of the exposed surface; or many if the mottled color occupies more than 20% of the exposed surface.

2. Size. Size refers to length of the mottle measured along the longest dimension and shall be described as fine if the mottle is less than 5 millimeters; medium if the mottle is from 5 millimeters to 15 millimeters; or coarse if the mottle is greater than 15 millimeters.

3. Contrast. Contrast refers to the difference in color between the soil mottle and the background color of the soil and is described as faint if the mottle is evident but recognizable with close examination; distinct if the mottle is readily seen but not striking; or prominent if the mottle is obvious and one of the outstanding features of the horizon.

4. Color. The color(s) of the mottle(s) shall be given.

(e) *Observed groundwater.* The depth to groundwater if present shall be reported. Observed groundwater shall be reported at the level groundwater reaches in the soil borehole, or at the highest level of side-wall seepage into the boring. Measurements shall be made from ground level. Soil above the water level in the boring shall be checked for the presence of soil mottles.

(f) *Color patterns not indicative of soil saturation.* 1. One foot exception. Soil profiles that have an abrupt textural change with finer textured soils overlying more than 4 feet of unmottled, loamy sand or coarser soils can have a mottled zone in the finer textured material. If the mottled zone is less than 12 inches thick and is immediately above the textural change, then a soil absorption system may be installed in the loamy sand or coarser material below the mottled layer. If any soil mottles occur within the sandy material, then the site shall be unsuitable. The county or department may determine certain coarse sandy loam soils to be included as a coarse material.

2. Other soil color patterns. Soil mottles can occur that are not due to zones of seasonal or periodic soil saturation. Examples of such soil conditions not limited by enumeration are:

a. Soil mottles formed from residual sandstone deposits.

b. Soil mottles formed from uneven weathering of glacially deposited material, or glacially deposited material that may be naturally gray in color. This may include concretionary material in various stages of decomposition.

c. Deposits of lime in a profile derived from highly calcareous parent material.

d. Light colored silt coats deposited on soil ped faces.

e. Soil mottles that are usually vertically oriented along old or decayed root channels with a dark organic stain usually present in the center of the mottled area.

3. Reporting exceptions. A certified soil tester shall report any mottled soil condition. If soil mottles are observed that may not be due to soil saturation, the soil tester still shall report such condition and may request a determination from the department or the county authority on the acceptability of the site.

(g) *Bedrock.* The depth to bedrock except sandstone shall be established at the depth in a soil boring where greater than 50% of the weathered in-place material is consolidated. Sandstone bedrock shall be established at the depth where an increase in resistance to penetration of a knife blade occurs.

(5) PERCOLATION TESTS AND PROCEDURES. (a) *Number and location.* At least 3 percolation tests in each system area shall be conducted. The holes shall be located uniformly in the location and to the bottom depth of the proposed absorption system. More percolation tests may be necessary depending on system design.

(b) *Exemption.* Percolation tests may not be required where a detailed soil map clearly indicates loamy sand or coarser material conditions at the depth of the proposed system, and for 3 feet below and the soil condition is confirmed by soil borings. The percolation rate for design purposes shall be calculated using the slowest permeability listed in the soil survey report for the map unit. The county or department may require proof of the map findings or soil texture and resultant anticipated percolation rate. The exemption of percolation tests does not eliminate the required bore hole test data.

(c) *Percolation test hole:* The test hole shall be dug or bored. It shall have vertical sides and have a horizontal dimension of 4 to 8 inches. The bottom and sides of the hole shall be carefully scratched with a sharp pointed instrument to expose the natural soil. All loose material shall be removed from the hole and the bottom shall be covered with 2 inches of gravel or coarse sand.

(d) *Test procedure—sandy soils.* For tests in sandy soils the hole shall be carefully filled with clear water to a minimum depth of 12 inches above the bottom of the hole. The time for this amount of water to seep away shall be determined and this procedure shall be repeated. If the water from the second filling of the hole seeps away in 10 minutes or less,

the test may proceed immediately as follows. Water shall be added to a point not more than 6 inches above the gravel or coarse sand. Thereupon, from a fixed reference point, water levels shall be measured at 10-minute intervals for a period of one hour. If 6 inches of water seeps away in less than 10 minutes, a shorter interval between measurements shall be used, but in no case shall the water depth exceed 6 inches. If 6 inches of water seeps away in less than 2 minutes, the test shall be stopped and a rate of less than 3 minutes per inch shall be reported. The final water level drop shall be used to calculate the percolation rate. Soils not meeting the above requirements shall be tested as in par. (e) below.

(e) *Test procedure—other soils.* The hole shall be carefully filled with clear water and a minimum water depth of 12 inches shall be maintained above the bottom of the hole for a 4-hour period by refilling whenever necessary or by use of an automatic siphon. Water remaining in the hole after 4 hours shall not be removed. Thereafter the soil shall be allowed to swell not less than 16 hours nor more than 30 hours. Immediately following the soil swelling period, the measurements for determining the percolation rate shall be made as follows. Any soil which has sloughed into the hole shall be removed and the water level shall be adjusted to 6 inches over the gravel or coarse sand. Thereupon, from a fixed reference point, the water level shall be measured at 30-minute intervals for a period of 4 hours unless 2 successive water level drops do not vary by more than 1/16 of an inch. At least 3 water level drops shall be observed and recorded. The hole shall be filled with clear water to a point not more than 6 inches above the gravel or coarse sand whenever it becomes nearly empty. Adjustment of the water level shall not be made during the last 3 measurement periods except to the limits of the last measured water level drop. When the first 6 inches of water seeps away in less than 30 minutes, the time interval between measurements shall be 10 minutes and the test run for one hour. The water depth shall not exceed 6 inches at any time during the measurement period. The drop that occurs during the final measurement period shall be used in calculating the percolation rate.

(f) *Mechanical test equipment.* Mechanical percolation test equipment shall be submitted to the department for approval.

(6) **VERIFICATION.** (a) *Borings.* Depth to soil mottles, depth to high groundwater, soil textures, depth to bedrock and land slope may be subject to verification by the county or the department. The county or the department may require backhoe pits to be provided for verification of soil boring data.

(b) *Percolation tests.* The results of percolation tests may be subject to verification by the county or the department. The county or the department may require that percolation tests be reconducted under supervision.

(c) *Filling.* Where the natural soil condition has been altered by filling or other methods used to improve wet areas, the department may require observation of high groundwater levels under saturated soil conditions.

(7) **MONITORING GROUNDWATER LEVELS.** (a) *General.* A property owner or developer has the option to provide documentation that soil mottling or other color patterns at a particular site are not an indication of seasonally saturated soil conditions or high groundwater levels. Documentation shall be made by observing water levels. Monitoring shall be in accord with the following procedures.

(b) *Precipitation.* Monitoring shall be done in a near normal spring season when the precipitation received at a local station equals or exceeds, for both the periods September 1st to March 1st and March 1st to June 1st, 8.5 inches and 7.6 inches respectively. In determining whether a near normal spring occurred, where sites are subject to broad regional water tables, such as large areas of sandy soils, the fluctuation over the several year cycle shall be considered. In such cases, data obtained from the United States geological survey shall be used to determine if a regional water table was at or near its normal level.

(c) *Artificial drainage.* Areas which are to be monitored shall be carefully checked for drainage tile and open ditches which could have altered natural high groundwater levels. Where such factors are involved, information on the location, design, ownership and maintenance responsibilities for such drainage shall be provided. Documentation shall be provided to show that the drainage network has an adequate outlet, and can and will be maintained. Sites affected by agricultural drain tile shall not be acceptable for system installation.

(d) *Procedures.* 1. Soil tester. Monitoring shall be done by a certified soil tester.

2. Notification. The certified soil tester shall notify in writing, the county sanitary permit issuing authority or the department, of intent to monitor. It is expected the county authority or department may field check the monitoring at least once during the time of expected saturated soil conditions.

3. Number of wells. At least 3 wells shall be monitored at a site for a proposed system and replacement. If in the judgement of the county authority or the department more than 3 monitoring sites are needed, the certified soil tester shall be so advised in writing.

4. Monitoring well design. Monitoring wells designed as shown in the following sketch shall be constructed for monitoring. At least 2 wells shall extend to a depth of at least 6 feet below ground surface and shall be a minimum of 3 feet below the designed system depth. However, with layered mottled soil over permeable unmottled soil, at least one well shall terminate within the mottled layer. Site conditions may, in some cases, require monitoring at greater depths. It will be the responsibility of the certified soil tester to determine the depth of the monitoring wells for each specific site and if in doubt, they shall request the guidance of the county or the department.

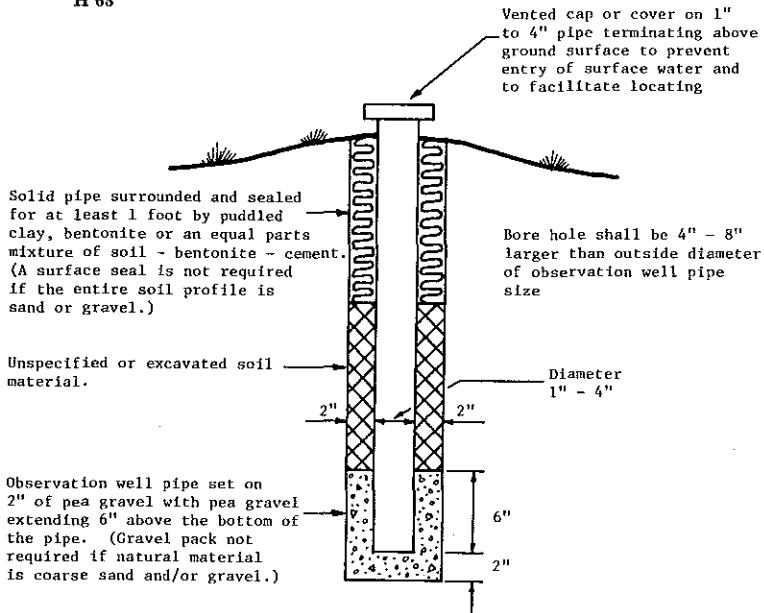

(e) *Observations.* 1. Minimum frequency. The first observation shall be made on or before March 15th. Observations shall be made thereafter every 7 days or less until June 1st or until the site is determined to be unacceptable, whichever comes first. If water is observed above the critical depth at any time, an observation shall be made 1 week later. If water is present above the critical depth at both observations, monitoring may cease because the site is considered unacceptable. If water is not present above the critical depth at the second observation, monitoring shall continue until June 1st. If any 2 observations 7 days apart show the presence of water above the critical depth, the site is unacceptable and the department shall be notified in writing.

2. More frequent interval. The occurrence of rainfall (s) of $\frac{1}{2}$ inch or more in a 24 hour period during monitoring may necessitate observations at more frequent intervals.

(f) *Reporting data.* 1. Unsuccessful site. When monitoring shows saturated conditions, data giving test locations, ground elevations at the wells, soil profile descriptions, soil series if available from soil maps, dates observed, depths to observed water and local precipitation data (monthly from September 1st to June 1st and daily during monitoring) shall be submitted in writing, with 2 copies sent to the department and one to the county authority.

2. Successful site. When monitoring discloses that the site is acceptable, documentation including location and depth of test holes, ground elevations at the wells, soil profile descriptions; soil series if available from soil maps; dates observed; results of observations, local precipitation data (monthly from September 1st to June 1st and daily during monitoring) and information on artificial drainage shall be submitted in writing, with 2 copies to the department and one to the county author-

ity. A request to install a soil absorption system shall be made to the department along with the appropriate review fee in s. H 63.08 (3) (c).

(8) **WINTER SOIL TESTING.** (a) *General.* Soil testing should be done only when weather and light conditions make accurate evaluation of site conditions possible. Soil testing attempted under winter conditions is difficult and precautions should be observed.

(b) *Soil borings.* Soil borings and profile evaluations conducted between November 15th and March 15th shall be in accord with the following procedures. Borings shall be made with a backhoe. Soil profiles shall only be evaluated between the hours of 10:00 a.m. and 2:00 p.m. Soil profiles shall not be evaluated during times when the sky is completely overcast. When soil horizons are frozen, soil material must be thawed for hand texturing.

(c) *Percolation tests.* Percolation tests that are unprotected shall be conducted only on days when the air temperature is 20° F. or higher and the wind velocity is 10 m.p.h. or less. A heated structure or other protection from freezing shall be provided when the weather conditions listed above are not met. The bottom of the percolation hole shall be at least 12 inches below frost depth. If water freezes in the test hole at any time, the test data shall be void.

History: Cr. Register, December, 1980, No. 300, eff. 1-1-81.

H 63.10 Site requirements. (1) **SOIL ABSORPTION SITE LOCATION.** The surface grade of all soil absorption systems shall be located at a point lower than the surface grade of any nearby water well or reservoir on the same or adjoining property, however, when this is not possible, the site shall be so located that surface water drainage from the site is not directed toward a well or reservoir and will by-pass the well or reservoir site by several feet. The soil absorption system shall be located not less than 5 feet from any lot line; 10 feet from a water service, or an uninhabited slab constructed building; 15 feet from a swimming pool or habitable slab constructed building measured from the slab; 25 feet from the below grade foundation of any occupied or habitable building or dwelling, public water main or cistern; 50 feet from any water well, reservoir or from the high water mark of any lake, stream or other watercourse. Private sewage systems in compacted areas such as parking lots and driveways are prohibited. Surface waters shall be diverted away from any soil absorption site on the same or neighboring lots.

(2) **GROUNDWATER, BEDROCK OR SLOWLY PERMEABLE SOILS.** There shall be a minimum of 3 feet of soil between the bottom of the soil absorption system and high groundwater, or bedrock. Soil having a percolation rate of 60 minutes per inch or faster shall exist for the depth of the proposed soil absorption system and for at least 3 feet below the proposed bottom of the soil absorption system. There shall be 56 inches of suitable soil from original grade for a conventional soil absorption system.

(3) **PERCOLATION RATE—TRENCH OR BED.** A subsurface soil absorption system of the trench or bed type shall not be installed where the percolation rate for any one of the 3 tests is slower than 60 minutes for water to fall one inch. The slowest percolation rate shall be used to determine the absorption area.

(4) **PERCOLATION RATE—SEEPAGE PIT.** For a seepage pit, percolation tests shall be made in each horizon penetrated below the inlet pipe. Soil

strata in which the percolation rates are slower than 30 minutes per inch shall not be included in computing the absorption area. The slowest percolation rate shall be used to determine the absorption area.

(5) **SOIL MAPS.** When a parcel of land consists entirely of soils having very severe or severe limitations for on-site liquid waste disposal as determined by use of a detailed soil map and interpretive data, that map and interpretive data may be used as a basis for denial for an on-site waste disposal system. However, the property owner shall be permitted to present evidence that a suitable site for an on-site liquid waste disposal system does exist.

(6) **FILLED AREA.** (a) *Departmental approval.* A soil absorption system shall not be installed in a filled area unless written approval is received from the department except if filled prior to certification as a subdivision lot under ch. H 65, Wis. Adm. Code.

(b) *Placement of fill.* Placement of fill does not guarantee approval for the installation of a soil absorption system. When evidence is made available showing that the filled area does meet the code requirements with regard to this area, percolation and elevation; departmental approval can be expected. This, in effect, would support application for a conventional system designed in fill.

(c) *Site and soil requirements.* 1. **Bedrock.** Sites that have less than 56 inches but at least 30 inches of soil over bedrock, where the original soil texture is sand or loamy sand (sand that has very few fine particles of silt or clay), may be filled with the same soil texture as the natural soil or coarser material up to and including medium sand in an attempt to overcome the site limitations. The fill material shall not be of a finer texture than the natural soil.

2. **High groundwater.** Sites that have less than 56 inches of soil over high groundwater or estimated high groundwater, where the original soil texture is sand or loamy sand (sand that has very few fine particles of silt or clay), may be filled following the criteria noted in this subsection.

3. **Natural soil.** Sites with soils finer than sand or loamy sand shall not be approved for systems in fill.

4. **Monitoring.** Sites that will have 36 inches of soil or less above high groundwater after the topsoil is removed shall be monitored for high groundwater levels in the filled area in accordance with s. H 63.09 (7).

5. **Inspection of fill.** Placement of the fill material shall be inspected by the county or the department.

(d) *Design requirements.* 1. **Size.** A filled area must be large enough to accommodate a shallow trench system and a replacement system. The size of the area that must be filled is determined by the percolation rate of the natural soil and use of the building. When any portion of the trench system or its replacement is in the fill, the fill shall extend 20 feet beyond all sides of both systems before the slope begins.

2. **Soil test.** Soil borings and percolation tests shall be conducted before filling to determine soil textures and depth to high groundwater or bedrock.

3. **Topsoil.** Vegetation and topsoil shall be removed prior to filling.

A. Excavation of complete hilltop

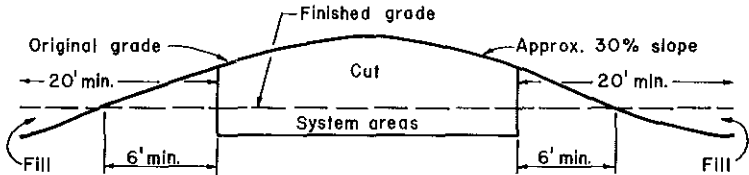

B. Excavation into hillside

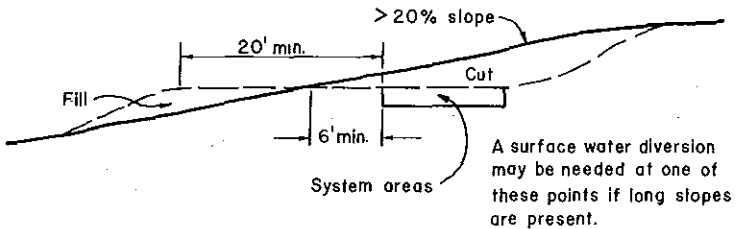

C. Regrade of hillside

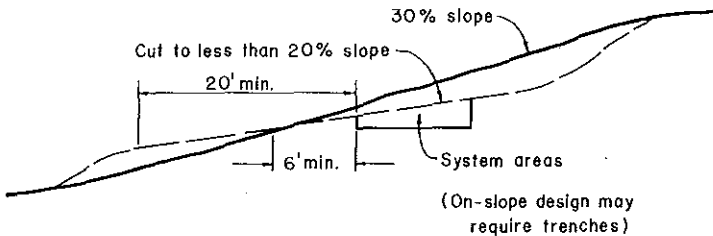

H 63.11 Initial adverse determination. In all cases where property owners and/or developers receive initial adverse determinations and sanitary permits are refused by the county or the department, rejecting the use of a conventional private sewage system because of site limitation, the aggrieved party shall be given the reason, in writing, for rejection and any alternate course of actions available to them. The department shall provide to all sanitary permit issuing agents a list of alternatives which may be applied in the event conventional means of waste disposal are not acceptable.

History: Cr. Register, December, 1980, No. 300, eff. 1-1-81.

H 63.12 Sizing soil absorption systems. (1) **GENERAL.** Effluent from septic tanks and other approved treatment tanks shall be disposed of by soil absorption or by such other manner approved by the department.

(a) *Daily wastewater volumes of 5,000 gallons or less.* For systems having a daily effluent application of 5,000 gallons or less, sizing shall be in accord with this section.

(b) *Daily wastewater volumes of 5,000 gallons or more.* For systems receiving effluents in excess of 5,000 gallons per day, this section shall apply except that 2 systems of equal size shall be required. Each system shall have a capacity of no less than 75% of the area required for a single system. A suitable means of alternating waste application shall be provided. The dual system shall be considered as one system.

(c) *Pressure system.* A pressure distribution network may be used in place of a conventional or dosing conventional soil absorption system where a site is suitable for a conventional private sewage system. Pressure distribution systems may be approved as an alternative private sewage system if the site is unsuitable for conventional treatment. For sizing and design criteria, see s. H 63.14.

(2) **METHOD OF DISCHARGE.** (a) *Daily flow 1,500 gallons or less.* For facilities having a daily effluent application of 1,500 gallons or less, flow from the septic or treatment tank to the soil absorption system may be by gravity or by dosing.

(b) *Systems over 1,500 gallons.* For systems over 1,500 gallons, the tank effluent must be discharged by pumping or by use of an automatic siphon.

Note: The dosing of effluents is recommended for all systems.

(3) **SIZING—RESIDENTIAL.** The bottom area for seepage trenches or beds or the side wall area for seepage pits required for a soil absorption system serving residential property shall be determined from the following table using soil percolation test data and type of construction:

Table 1

Percolation Class	Percolation Rate Minutes Required for Water to Fall One Inch	Minimum Absorption		Area in Square Feet	
		Public Buildings		Residential Property per bedroom	
		Seepage Trenches or Pits	Seepage Beds	Seepage Trenches or Pits	Seepage Beds
Class 1	0 to less than 10	110	140	165	205
Class 2	10 to less than 30	165	205	250	315
Class 3	30 to less than 45	200	250	300	375
Class 4	45 to 60	220	280	330	415

(4) SIZING—PUBLIC BUILDINGS. The minimum soil absorption system area for public buildings is dependent upon building usage, the percolation rate and the system design. Tables 1 and 2 shall be used to calculate the required area. The following formula shall be used: (Factor in Column 3, Table 2) x (Number of units) x (Min. Absorption Area from Table 1).

HEALTH AND SOCIAL SERVICES

278-27
H 63

Table 2

COLUMN 1	COLUMN 2	COLUMN 3
Building Classification	Units	Factor
Apartment building.....	1 per bedroom	1.5
Assembly hall—no kitchen	1 per person	0.02
Bar and cocktail lounge.....	1 per patron space	0.2
Beauty salon.....	1 per station.....	2.4
Bowling alley.....	1 per bowling lane.....	2.5
Bowling alley with bar.....	1 per bowling lane.....	4.5
Camp, day use only.....	1 per person.....	0.2
Camp, day and night.....	1 per person.....	0.45
Campground and camping resort.....	1 per camping space.....	0.9
Campground and sanitary dump station	1 per camping space	0.085
Car wash (automatic).....	Subject to state approval	
Car wash (per car handwash)	1 per car	1.0
Catch basin—garages, service stations, etc.	1 per basin	2.0
Catch basin—truck wash	1 per truck	5.0
Church—no kitchen	1 per person.....	0.04
Church—with kitchen.....	1 per person.....	0.09
Condominium.....	1 per bedroom	1.5
Country club.....	Subject to state approval	
Dance hall.....	1 per person.....	0.06
Dining hall—kitchen and toilet	1 per meal served.....	0.2
Dining hall—kitchen only.....	1 per meal served.....	0.06
Dining hall—kitchen and toilet waste with dishwasher and/or food waste disposer	1 per meal served.....	0.25
Drive-in restaurant (all paper service)	1 per car space	0.3
Drive-in restaurant (inside seating)	1 per seat.....	0.3
Drive-in theater	1 per car space	0.1
Employees—in all buildings	1 per person.....	0.4
Hotel or motel and tourist rooming house.....	1 per room.....	0.9
Floor drain.....	1 per drain	1.0
Hospital.....	1 per bed space	2.0
Medical office buildings, clinics and dental offices		
Doctors, nurses and medical staff	1 per person.....	0.8
Office personnel	1 per person.....	0.25
Patients	1 per person.....	0.15
Migrant labor camp—central bathhouse.....	1 per employe.....	0.25
Mobile home (single installation)	(Use H 63.12 (3))	
Mobile home park	1 per mobile home site	3.0
Nursing or rest homes	1 per bed space	1.0
Outdoor sports facility—toilet waste only.....	1 per person.....	.085
Park—toilet waste only.....	1 per acre	4.0
Park—showers and toilets	1 per acre	8.0
Restaurant—kitchen waste only	1 per seating space.....	0.18
Restaurant—toilet waste only	1 per seating space.....	.42
Restaurant—kitchen and toilet.....	1 per seating space.....	0.6
Restaurant—(24-hr) kitchen and toilet	1 per seating space.....	1.2
Restaurant—dishwasher and/or food waste disposer	1 per seating space.....	.15
Restaurant—(24-hr) with dishwasher/dispenser.....	1 per seating space.....	1.5
Retail store	1 per customer	0.03
(Number of customers = 70% total area divided by 30 square feet/customer.)		
Self-service laundry—toilet wastes only.....	1 per machine.....	1.0
Auto washer (service bldgs., etc.)	1 per machine.....	6.0
Service station.....	1 per car served	0.15

Table 2 (continued)

COLUMN 1	COLUMN 2	COLUMN 3
Building Classification	Units	Factor
Swimming pool bathhouse	1 per person	0.2
School—no meals, no showers	1 per classroom	5.0
School—meals served or showers	1 per classroom	6.7
School—meals and showers	1 per classroom	8.0
Showers—public	1 per shower	0.3

History: Cr. Register, December, 1980, No. 300, eff. 1-1-81.

H 63.13 Installation—conventional soil absorption systems. (1) **SEEPAGE TRENCH EXCAVATIONS.** Seepage trench excavations shall be 1 to 5 feet in width. Trench excavations shall be spaced at least 6 feet apart. The absorption area of a seepage trench shall be computed by using the bottom area only. The bottom area of the distribution header excavation shall not be computed as absorption area. Individual seepage trenches should not be over 100 feet long.

(2) **SEEPAGE BED EXCAVATIONS.** Seepage bed excavations shall be more than 5 feet wide and have more than one distribution pipe. The absorption area of a seepage bed shall be computed by using the bottom area only. Distribution piping in a seepage bed shall be uniformly spaced, no more than 6 feet and no less than 3 feet apart, and no more than 3 feet or less than 1 foot from the sidewall.

(3) **SEEPAGE PITS.** A seepage pit shall have a minimum inside diameter of 5 feet and shall consist of a chamber walled-up with material such as perforated precast concrete ring, concrete block, brick or other material approved by the department which allows effluent to percolate into the surrounding soil. The pit bottom shall be left open to the soil. Aggregate of $\frac{1}{2}$ to 2 $\frac{1}{2}$ inches in size shall be placed into a 6-inch minimum annular space separating the outside wall of the chamber and sidewall excavation. The depth of the annular space shall be measured from the inlet pipe to the bottom of the chamber. Each seepage pit shall be provided with a 24-inch manhole extending to within 6 inches of the ground surface and a 4-inch diameter fresh air inlet which shall meet the requirements of sub. (7). An observation pipe is not required. Seepage pits shall be located 6 feet or more apart. Excavation and scarifying shall be in accord with sub. (4). The effective area of a seepage pit shall be the vertical wall area of the walled-up chamber for the depth below the inlet for all strata for which the percolation rates are less than 30 minutes per inch. The 6 inches of annular opening outside the vertical wall area may be included for determination of effective area. Table 3 may be used for determining the effective sidewall area of circular seepage pits:

Table 3

EFFECTIVE ABSORPTION AREA FOR SEEPAGE PITS

Inside diameter of chamber in feet plus 1 foot for wall thickness plus one foot for annular space	Depth in feet of Permeable Strata Below Inlet					
	3	4	5	6	7	8
7.....	75	101	126	151	176	201
8.....	85	113	142	170	198	226
9.....	94	126	157	188	220	251
10.....	104	138	173	208	242	277
12.....	123	163	204	245	286	327

(4) **EXCAVATION AND CONSTRUCTION.** The bottom of a trench or bed excavation shall be level. Seepage trenches or beds shall not be excavated when the soil is so wet that soil material rolled between the hands will form a soil wire. All smeared or compacted soil surfaces in the side walls or bottom of the seepage trench or bed excavation shall be scarified to the depth of smearing or compaction and the loose material removed. If rain falls on an open excavation, the soil must be left until dry enough that a soil wire will not form when soil from the excavation bottom is

rolled between the hands. The bottom area shall then be scarified and loose material removed.

(5) **AGGREGATE AND BACKFILL.** A minimum of 6 inches of aggregate ranging in size from $\frac{1}{2}$ to $2\frac{1}{2}$ inches shall be laid into the trench or bed below the distribution pipe elevation. The aggregate shall be evenly distributed a minimum of 2 inches over the top of the distribution pipe. The aggregate shall be covered with synthetic materials approved by the department or with 9 inches of uncompacted marsh hay or straw. Building paper shall not be used to cover the aggregate. A minimum of 18 inches of soil back fill shall be provided above the covering.

(6) **DISTRIBUTION PIPING.** (a) *General.* Distribution piping for gravity systems shall be a minimum of 4 inch I.D. approved pipe. The distribution header shall be constructed of approved solid wall pipe. The top of the distribution piping shall be laid 8 to 42 inches below the original surface in continuous straight or curved lines. The slope of the distribution pipes shall be 2 to 4 inches per 100 feet.

(b) *Distribution of effluent.* Effluent should be distributed equally to all distribution pipes. Distribution of effluent to seepage trenches on sloping sites may be accomplished by utilizing a drop box design. Where dosing is required, the siphon or pump shall discharge a dose of minimum capacity equal to 75% of the combined volume of the distribution piping in the absorption system. See s. H 63.12 (1) (b).

(7) **FRESH AIR INLETS AND OBSERVATION PIPE.** Fresh air observation inlets of cast iron shall be provided and connected to the perforated distribution pipe with an approved fitting or junction box and be placed so as to assure a free flow of air throughout the entire installation. The vent pipes shall be at least 4 inches in diameter and extend at least 12 inches above the final grade and terminate with an approved vent cap. The observation pipe shall be perforated and extend to the bottom of the aggregate. See following sketch. Fresh air inlets shall be located at least 25 feet from any window, door or air intake of any building used for human habitation. A maximum of 4 distribution pipe lines may be served by one common 4-inch vent when interconnected by a common header pipe.

Fresh Air Inlets And Observation Pipe

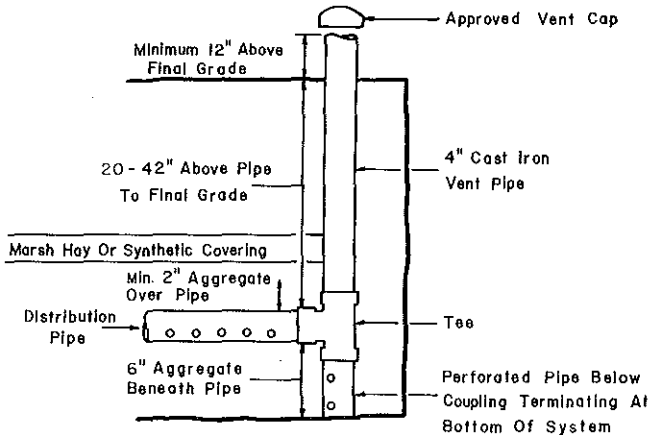

(8) **WINTER INSTALLATION.** (a) *General.* Installation of soil absorption systems during periods of adverse weather conditions is not recommended. A soil absorption system shall not be installed if the soil at the system elevation is frozen.

(b) *Removal of snow cover.* Snow cover must be removed from the soil absorption area before excavation begins. Snow must not be placed in a manner that will cause water to pond on the soil absorption system area during snowmelt.

(c) *Excavated and backfill material.* Excavated soil material may be used as backfill for the system if the following conditions are met: The excavated material must be protected from freezing. If the excavated material freezes solid, it shall not be used as backfill. The first 12 inches of backfill shall be loose, unfrozen soil. The protective covering over the bed or trench gravel shall be a synthetic material approved by the department or 9 inches of uncompacted marsh hay or straw.

(d) *System inspection.* Inspection of systems installed during winter conditions shall include inspection of the trench or bed excavation prior to placement of gravel and inspection of backfill material at the time of placement.

History: Cr. Register, December, 1980, No. 300, eff. 1-1-81.

H 63.14 Pressure distribution systems. (1) **GENERAL.** A pressure distribution system may be used on any site meeting the conventional private sewage system criteria listed in s. H 63.10. A pressure distribution system may be approved as an alternative private sewage system under s. H 63.22. There shall be a minimum depth to the top of the distribution piping of 6 inches from original grade for any pressure distribution system approved as an alternative private sewage system. The minimum required suitable soil depths from original grade for an alter-

native private sewage system using a pressure distribution network are as follows:

- 1 inch distribution pipe—49 inches suitable soil
- 2 inch distribution pipe—50 inches suitable soil
- 3 inch distribution pipe—52 inches suitable soil
- 4 inch distribution pipe—53 inches suitable soil

Department approval is required for use of a pressure distribution system.

(2) **ABSORPTION AREA.** (a) *Sizing.* The total absorption area required shall be computed from the estimated daily wastewater flow and the design loading rate. The required absorption area equals wastewater flow divided by the design loading rate from Table 4.

(b) *Estimating wastewater flow.* 1. Residential. The estimated wastewater flow from a residence shall be 150 gallons per bedroom per day.

2. Public buildings. Daily wastewater flow rates for public buildings shall be based on the usage factors listed in s. H 63.15 (3) (c) 2.

(c) *Design loading rate.* The design loading rate for a site is based on the percolation rate for the site. Table 4 shall be used to determine the design loading rate.

Table 4

DESIGN LOADING RATE TABLE

Percolation Rate	Design Loading Factor
0 to less than 10 min/in	1.2 gal/sq ft/day
10 to less than 30 min/in	.8 gal/sq ft/day
30 to less than 45 min/in	.72 gal/sq ft/day
45 to 60 min/in	.4 gal/sq ft/day

(3) **PRESSURE DISTRIBUTION SYSTEM DESIGN.** (a) *General.* Pressure distribution systems may discharge effluent into trenches or beds. Each pipe that is connected to an outlet of a manifold shall be counted as a separate distribution pipe. The horizontal spacing of distribution pipes shall be 30 to 72 inches. (See following sketch.) All distribution piping should be installed at the same elevation, or the plans and specifications shall provide for a design that insures equal flow through each of the perforations.

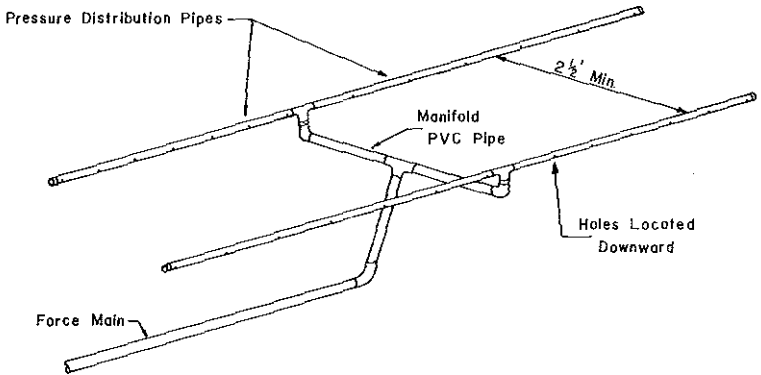

Bed Design Is Recommended Over Trenches

(b) *Design calculations.* Pressure distribution systems requiring less than 5,000 square feet of absorption area shall be designed using Tables 5 through 11. Systems requiring more than 5,000 square of absorption area shall be designed using design specifications and calculations other than those specified in Tables 5 through 11. Design specifications and calculations must be submitted and include perforation discharge rate, total headloss through the distribution piping, headloss through manifold piping, pump or siphon size and dosing volume. Formulas for these calculations may be obtained from the department.

(c) *Distribution pipe size.* Distribution pipe diameters may vary depending on the length of bed or trenches. Table 5 specifies maximum allowable distribution pipe lengths for various pipe and perforation sizes.

(d) *Manifolds.* 1. Size. The size of the manifold is based on the number, length and discharge rate of the distribution pipes. Table 6 shall be used for calculating distribution pipe discharge rate. Table 7 shall be used for calculating manifold diameter.

2. Distribution pipe connection. Distribution pipes should be connected to the manifold with tee's or 90° ells. Distribution pipes shall have the ends capped.

(e) *Force main.* The size of the force main between the pump and the manifold shall be based on the friction loss and velocity of effluent through the pipe. Force mains shall be constructed of approved pipe.

(4) **BED AND TRENCH CONSTRUCTION.** (a) *General.* The excavation and construction requirements for pressure distribution system trenches and beds shall meet the requirements specified in s. H 63.13 (1), (2), (4), (5), (8).

(b) *Aggregate.* Aggregate shall be placed to a minimum depth of 6 inches beneath the distribution pipe with 2 inches spread evenly above the pipe. The aggregate shall be clean, non-deteriorating 1/2 to 2 1/2 inch stone.

Table 5: Required Distribution Pipe Diameters For Various Hole Diameters, Hole Spacings
And Distribution Pipe Lengths (for plastic pipe only)

Distribution Pipe Length (ft.)	Distribution Pipe Diameter (in.)																																		
	Hole Diameter (in.) $\frac{1}{4}$							Hole Diameter (in.) $\frac{5}{16}$							Hole Diameter (in.) $\frac{3}{8}$							Hole Diameter (in.) $\frac{7}{16}$							Hole Diameter (in.) $\frac{1}{2}$						
	Hole Spacing (ft.)							Hole Spacing (ft.)							Hole Spacing (ft.)							Hole Spacing (ft.)							Hole Spacing (ft.)						
	2	3	4	5	6	7	2	3	4	5	6	7	2	3	4	5	6	7	2	3	4	5	6	7	2	3	4	5	6	7					
10																						1"													
15																						1"													
20	1"							1"							1"							1"													
25	1"							1"							1"							1"													
30	1"							1"							1"							1"													
35	1"							1"							1"							1"													
40	1"							1"							1"							1"													
45	1"							1"							1"							1"													
50	1"							1"							1"							1"													

278-34
H 63

WISCONSIN ADMINISTRATIVE CODE

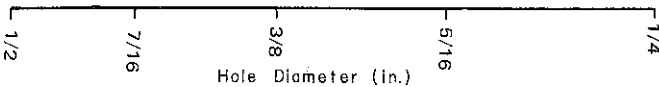
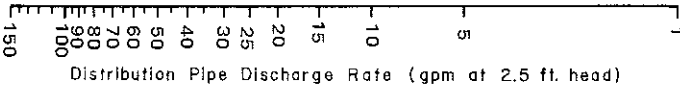
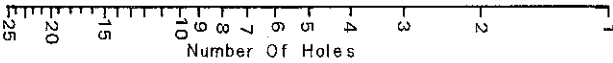
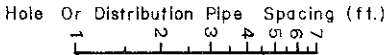
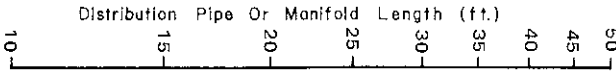

Table 6

Table 7: Recommended Manifold Diameters For Various Manifold Lengths, Number Of Distribution Pipes, And Distribution Pipe Discharge Rates (for plastic pipe only)

		Manifold Diameter (in.)																						End Manifold																												
		Manifold Length (ft.)																																																		
		5'	10'	15'	20'	25'	30'	35'	40'	45'	50'	5'	10'	15'	20'	25'	30'	35'	40'	45'	50'																															
Central Manifold	FLOW PER PIPE (gpm)	Number Of Distribution Pipes With Central Manifold																						FLOW PER PIPE (gpm)																												
	4	6	4	6	8	10	4	6	8	10	12	6	8	10	12	14	6	8	10	12	14	6	8	10	12	14	16	6	8	10	12	14	16	18	20	6	8	10	12	14	16	18	20	22								
	5	1"	1 1/4"	1 1/4"	1 1/2"	2"	1 1/4"	1 1/2"	2"	2"		2"	2"		2"		2"			2"		3"	2"		3"		2"		3"		2"		3"		2"		3"		4"	10												
	10	1 1/4"	1 1/2"	1 1/2"	2"		2"		2"		3"		3"		3"		3"			3"		4"		4"		4"		4"		4"		4"		4"		4"		4"		4"		4"		4"	20							
	15	1 1/2"	2"																																											30						
20	2"	3"		3"		3"		3"		4"		4"		4"		4"			4"		6"		6"		6"		6"		6"		6"		6"		6"		6"		6"		6"		6"	40								
25				4"		4"		4"		4"		4"		6"		6"		6"		6"		6"		6"		6"		6"		6"		6"		6"		6"		6"		6"		6"		6"	50							
		Number Of Distribution Pipes With End Manifold																																																		
		2	3	2	3	4	5	2	3	4	5	6	3	4	5	6	7	3	4	5	6	7	3	4	5	6	7	8	3	4	5	6	7	8	9	3	4	5	6	7	8	9	10	3	4	5	6	7	8	9	10	11

(c) *County inspection.* The county inspector shall inspect pressure systems at the time the aggregate is started to be placed and while the distribution piping is being installed.

(5) PUMPS AND PUMP CONTROLS. (a) *Pump selection.* Pump selection is to be based on the pump performance curve. The total dynamic head shall be equal to:

1. Elevation. The elevation difference between the pump and distribution pipe invert.
2. Friction loss. The friction loss in the pipe between the pump and the supply end of the distribution pipe.
3. Head. A head at the supply end of the distribution pipe of 2.5 feet.
4. Total dynamic head equals elevation head plus friction loss plus 2.5 feet of supply end head.

(b) *Discharge rate.* Table 8 shall be used to determine pump dosing rate based on the distribution pipe discharge rate and number of distribution pipes.

(c) *Friction loss.* Table 9 is the friction loss chart for schedule 40 plastic pipe (C = 150). The diameter of the pipe shall be increased if the velocity falls in the excessive range based upon flow rates in Table 9.

(d) *Pump and alarm controls.* 1. General controls. The control system for the pumping chamber shall consist of a control for operating the pump and an alarm system to detect when the pump is malfunctioning. Pump controls should be selected which give flexibility in adjusting the on/off depth. All pump and alarm controls shall be approved by the department. Pressure diaphragm switches shall not be used. The following types of controls may be used.

a. Mercury level control. Mercury level control switches consist of a mercury switch sealed inside a bulb. Strictly an on/off switch, two are required.

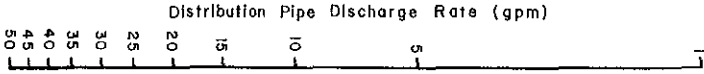

Number Of Distribution Pipes

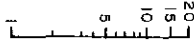

Dosing Rate (gpm)



Table 8

Table 9
FRICITION LOSS IN SCHEDULE 40 PLASTIC PIPE (C = 150)

Flow	Pipe Diameter (in)								
	1	1-1/4	1-1/2	2	3	4	6	8	10
gpm	ft/100 ft								
1	0.07								
2	0.28	0.07							
3	0.60	0.16	0.07						
4	1.01	0.25	0.12						
5	1.52	0.39	0.18						
6	2.14	0.55	0.25	0.07					
7	2.89	0.76	0.36	0.10					
8	3.63	0.97	0.46	0.14					
9	4.57	1.21	0.58	0.17					
10	5.50	1.46	0.70	0.21					
11		1.77	0.84	0.25					
12		2.09	1.01	0.30					
13		2.42	1.17	0.35					
14		2.74	1.33	0.39					
15		3.06	1.45	0.44	0.07				
16		3.49	1.65	0.50	0.08				
17		3.93	1.86	0.56	0.09				
18		4.37	2.07	0.62	0.10				
19		4.81	2.28	0.68	0.11				
20		5.23	2.46	0.74	0.12				
25			3.75	1.10	0.16				
30			5.22	1.54	0.23				
35				2.05	0.30	0.07			
40				2.62	0.39	0.09			
45				3.27	0.48	0.12			
50				3.98	0.58	0.16			
60					0.81	0.21			
70					1.08	0.28			
80					1.38	0.37			
90					1.73	0.46			
100					2.09	0.55	0.07		
125						0.85	0.12		
150						1.17	0.16		
175						1.56	0.21		
200							0.28	0.07	
250							0.41	0.11	
300							0.58	0.16	
350							0.78	0.20	0.07
400							0.99	0.26	0.09
450							1.22	0.32	0.11
500								0.38	0.14
600								0.54	0.18
700								0.72	0.24
800									0.32
900									0.38
1000									0.46

Velocities in this area
become too great for the
various flow rates and
pipe diameter.

b. Adjustable weight switch. Adjustable weight switches consist of a control located above the water level and 2 weights attached to a single cable which extends into the liquid.

2. Alarm system. The alarm system shall consist of a bell or light mounted in the structure and shall be located so it can be easily seen or heard. The high water warning device shall be installed 2 inches above the depth set for the on pump control. Alarm systems shall be installed on a separate circuit from the electrical service.

3. Electrical connections. Electrical connections shall be located outside the pumping chamber. All wiring to the pump chamber shall be installed in a conduit.

(6) Dosing. The dosing frequency shall be a maximum of 4 times daily. To establish the volume per dose, divide the daily wastewater flow by the dosing frequency. In addition, the dosing volume shall be at least 10 times the capacity of the distribution pipe volume. Table 10 provides the void volume for various pipe diameters. Table 11 shall be used to determine minimum dose volume based on distribution pipe diameter, length and number of distribution pipes.

Table 10
VOID VOLUME FOR VARIOUS DIAMETER PIPES

Diameter inch	Volume gal/ft length
1	.041
1 ¼	.064
1 ½	.092
2	.164
3	.368
4	.655
6	1.47

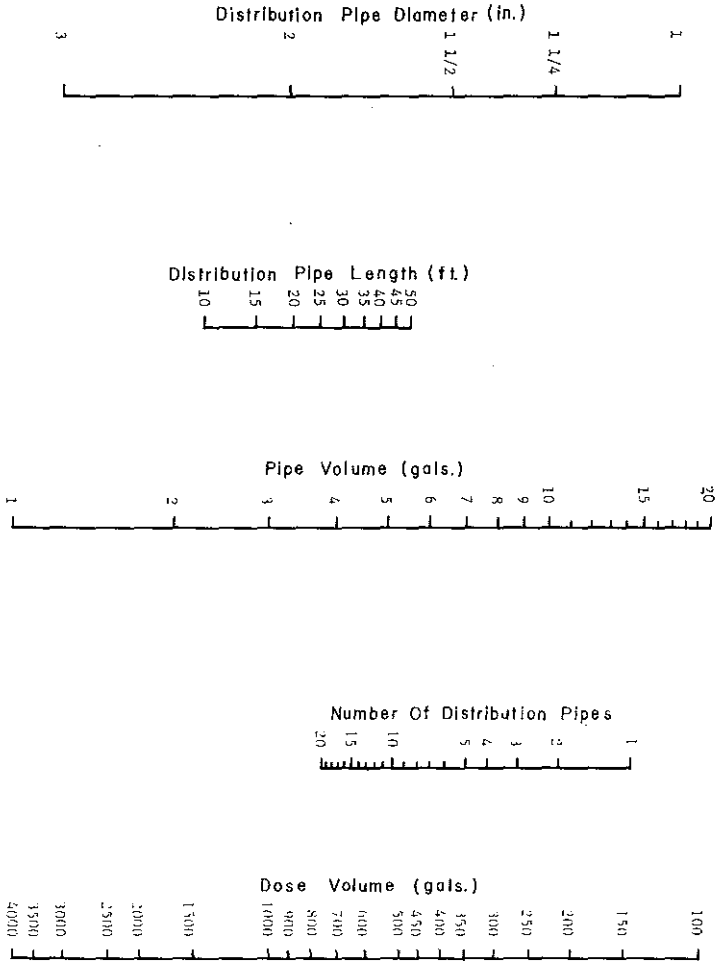

Table II

H 63.15 Septic tanks and other treatment tanks. (1) **GENERAL.** Septic tanks shall be fabricated or constructed of welded steel, monolithic concrete, fiberglass or other materials approved by the department. All tanks shall be watertight and fabricated so as to constitute an individual structure. The design of prefabricated septic tanks shall be approved by the department. Plans for site-constructed concrete tanks shall be approved by the department prior to construction.

(2) **DESIGN OF SEPTIC TANKS.** (a) *Liquid depth.* The liquid depth shall not be less than 3 feet nor more than an average of 6 feet. The total depth shall be at least 8 inches greater than the liquid depth.

(b) *Rectangular tanks.* Rectangular tanks shall have a minimum width of 36 inches and shall be constructed with the longest dimensions parallel to the direction of flow.

(c) *Cylindrical tanks.* Cylindrical tanks shall have an inside diameter of not less than 48 inches.

(d) *Label.* Each prefabricated tank shall be clearly marked to show liquid capacity and the name and address or registered trade mark of the manufacturer. The markings shall be impressed into or embossed onto the outside wall of the tank immediately above the outlet opening. Each site-constructed concrete tank shall be clearly marked at the outlet opening to show the liquid capacity. The marking shall be impressed into or embossed onto the outside wall of the tank immediately above the outlet opening.

(e) *Materials.* For septic tank material and construction specifications, see s. H 63.20.

(f) *Inlet and outlet.* The inlet and outlet on all tanks or tank compartments shall be provided with open-end coated sanitary tees or baffles made of approved materials, so constructed as to distribute flow and retain scum in the tank or compartments. The inlet and outlet openings on all tanks shall contain a "boss" stop or other provision which will prevent the insertion of the sewer piping beyond the inside wall of the tank. The tees or baffles shall extend at least 6 inches above and 9 inches below the liquid level, but not to exceed $\frac{1}{3}$ the liquid depth. At least 2 inches of clear space shall be provided over the top of the baffles or tees. The bottom of the outlet opening shall be at least 2 inches lower than the bottom of the inlet.

(g) *Manholes.* Each single-compartment tank and each unit of a multi-compartment tank shall be provided with at least one manhole opening located either over the inlet or outlet opening, no less than 24 inches square or 24 inches in diameter. Manholes shall terminate a maximum of 6 inches below the ground surface and be of the same material as the tank. Steel tanks shall have a minimum 2-inch collar for the manhole extensions permanently welded to the tank. The manhole extension on fiberglass tanks shall be of the same material as the tank and an integral part of the tank. The collar shall have a minimum height of 2 inches.

(h) *Manhole covers.* Manhole risers must be provided with a substantial, fitted, watertight cover of concrete, steel, cast iron or other material approved by the department. Manhole covers which terminate above grade shall have an effective locking device which meets with department approval. A 4 x 6 inch label printed in red or other contrasting

color must be affixed to the cover warning of the hazards present when entering a septic tank. The wording used on the warning label shall be approved by the department as part of the materials approval for the tank.

(i) *Inspection opening.* An airtight inspection opening which may be either a manhole or a cast iron pipe at least 4 inches in diameter, shall be provided over either the inlet baffle or outlet baffle which does not have the manhole above it for all treatment tanks. The upper end of the inspection pipe shall terminate 6 inches above final grade.

(3) **CAPACITY AND SIZING.** (a) *Minimum capacity.* The capacity of a septic tank or other treatment tank shall be based on the number of persons using the building to be served or upon the volume and type of waste. The minimum liquid capacity shall be 750 gallons.

(b) *Multiple tanks.* When the required capacity is to be provided by more than one tank, the minimum capacity of any tank shall be 750 gallons. When 3 or 4 tanks are installed, approval of the design of the system shall be obtained from the department. The installation of more than 4 tanks in series is prohibited. Installation of septic tanks in parallel is prohibited.

(c) *Sizing of tank.* 1. Residential. The minimum liquid capacity for one and 2 family residences is as follows:

SEPTIC TANK CAPACITY ONE AND TWO FAMILY RESIDENCES

Number of Bedrooms	Septic Tank
1.....	750
2.....	750
3.....	975
4.....	1,200
5.....	1,425
6.....	1,650
7.....	1,875
8.....	2,100

2. Public buildings. For buildings other than one and two family residences the liquid capacity shall be increased above the 750-gallon minimum as established in Table 12. For such buildings having kitchen and/or laundry waste, the tank capacity shall be increased to receive the anticipated volume for a 24-hour period from the kitchen and/or laundry. The liquid capacities established in Table 12 do not include employees.

Table 12

Apartment buildings (per bedroom—includes auto washer)	150 gals.
Assembly hall (per person—no kitchen)	2 gals.
Bars and cocktail lounges (per patron space)	9 gals.
Beauty salons (per station—includes customers)	140 gals.
Bowling alley (per alley)	125 gals.
Bowling alley with bar (per alley)	225 gals.
Campgrounds and camping resorts (per camp space)	100 gals.
Campground sanitary dump stations (per camp space)	5 gals.
(omit camp spaces with sewer connection)	
Camps, day use only—no meals served (per person)	15 gals.
Camps, day and night (per person)	40 gals.
Car wash (automatic)—subject to state approval	
Car wash (per car handwash)	50 gals.
Catch basins—garages, service stations, etc. (per basin, etc.)	100 gals.

Catch basins—truck washing (per truck)	100 gals.
Churches—no kitchen (per person)	3 gals.
Churches—with kitchen (per person)	7.5 gals.
Condominiums (per bedroom—includes auto washer)	150 gals.
Country clubs—subject to state approval	
Dance halls (10 sq. ft. per person)	3 gals.
Dining hall—kitchen and toilet waste—with dishwasher and/or with disposer (per meal served)	11 gals.
Dining hall—kitchen waste only (per meal served)	3 gals.
Drive-in restaurants—all paper service (per car space)	15 gals.
Drive-in restaurants—all paper service inside seating (per seat)	15 gals.
Drive-in theaters (per car space)	5 gals.
Employee—in all buildings, per employee—total all shifts	20 gals.
Floor drain (per drain)	50 gals.
Hospitals (per bed space)	200 gals.
Hotels or motels and tourist rooming houses (per room—2 persons per room)	100 gals.
Medical office buildings, clinics and dental offices	
Doctors, nurses, medical staff (per person)	75 gals.
Office personnel (per person)	20 gals.
Patients (per person)	15 gals.
Migrant labor camp, central bathhouse (per employee)	30 gals.
Mobile homes, single installation (use H 63.15 (3) (c) 1)	
Mobile home parks, homes with bathroom groups (per site)	300 gals.
Nursing and rest homes—without laundry (per bed space)	100 gals.
Outdoor sport facilities (toilet waste only—per person)	5 gals.
Parks, toilet wastes (per person—75 persons per acre)	5 gals.
Parks, with showers and toilet wastes (per person—75 persons per acre)	10 gals.
Restaurant—kitchen waste only—without dishwasher and/or disposer (per seat)	9 gals.
Restaurant—toilet waste only (per seat)	21 gals.
Restaurant—kitchen and toilet wastes (per seating space)	30 gals.
Restaurant (24-hr)—kitchen and toilet wastes (per seating space)	60 gals.
Restaurant—dishwasher and/or food waste disposer (per seat)	3 gals.
Restaurant (24-hr)—dishwasher and/or food waste disposer (per seat)	6 gals.
Retail store—customers	1.5 gals.
(Number of customers = 70% total area divided by 30 square feet/customer.)	
Schools (per classroom—25 pupils per classroom)	450 gals.
Schools with meals served (per classroom—25 pupils per classroom) ...	600 gals.
Schools with meals served and showers provided (per classroom)	750 gals.
Self-service laundries (toilet waste only, per machine)	50 gals.
Auto washer (apartments, service buildings, etc.—per machine)	300 gals.
Service stations (per car)	10 gals.
Showers—public (per shower taken)	15 gals.
Swimming pool bathhouses (per person)	10 gals.

(4) **INSTALLATION.** (a) *Location.* Septic and other treatment tanks shall not be located within 5 feet of any building or its appendage, water service, 2 feet of any lot line, 10 feet of any cistern, 15 feet of any pool, 25 feet of any well, reservoir or high water mark of any lake, stream, pond or flowage, within the interior foundation walls of a building nor shall a new building or addition to an existing building be constructed or located over or within 5 feet of a tank.

(b) *Groundwater.* If the tank is installed in groundwater, adequate anchoring provisions shall be made.

(c) *Bedding.* A 3-inch thick compacted bedding shall be provided for all septic and other treatment tank installations. The bedding material shall be sand, gravel, granite, limerock or other noncorrosive materials of such size that 100% will pass a ½-inch screen.

(d) *Backfill*. 1. Steel and fiberglass tanks. The backfill material for steel and fiberglass tanks shall be as specified for bedding and shall be tamped into place, care being taken to prevent damage to the coating.

2. Concrete tanks. The backfill for concrete tanks shall be soil material, 100% of which shall pass a 4-inch screen and shall be tamped into place.

(e) *Piping*. The inlet and outlet piping between a septic or other treatment tank and points 3 feet beyond the undisturbed ground surrounding the excavation made to install each tank and all piping connecting tanks shall be cast iron pipe or other pipe approved by the department for the specific purpose. The piping 3 feet beyond the undisturbed ground on the outlet side of the septic tank shall comply with the materials specified in s. H 62.04, Wis. Adm. Code. The joints between pipe and tank openings shall be made with lead and oakum or other methods approved by the department.

(f) *Manhole riser joints*. 1. Concrete. All joints on concrete risers and manhole covers shall be tongue and groove or shiplap type and sealed watertight using neat cement, mortar or bituminous compound.

2. Steel. All joints on steel risers shall be welded or flanged and bolted and be watertight. All steel manhole extensions shall be bituminous coated inside and outside.

3. Fiberglass. All methods of attaching fiberglass risers shall be watertight and approved by the department.

(5) **DOSING OR PUMPING CHAMBERS.** (a) *Material and construction*. Dosing or pumping chambers shall be fabricated or constructed of welded steel, monolithic concrete, glass-fiber reinforced polyester or other approved materials. Manholes for dosing or pumping chambers shall terminate a minimum of 4 inches above the ground surface. All dosing or pumping chambers shall be watertight and materials and construction specifications must meet the same criteria specified for septic tanks in this section.

(b) *Capacity sizing*. The working capacity of the dosing or pumping chamber shall be sized to permit automatic discharge of the total daily sewage flow with discharge occurring no more than 4 times per 24 hours. The minimum capacity of a dosing chamber shall be 500 gallons. Dosing or pumping chambers shall be provided with a minimum 4-inch cast iron vent extended at least 12 inches above final grade and terminate with an approved vent cap and be a minimum of 25 feet from a door, window or fresh air intake. A dosing chamber shall have a 1-day holding capacity above the high water alarm for residences, based on 100 gallons per day per bedroom, or in the case of public buildings in accordance with sub. (3). Table 13 lists minimum pump chamber sizes for residences.

Table 13
PUMP CHAMBER SIZES

Home Size No. Bedrooms	Minimum Pumping Chamber Size Gallons
1	500
2	500
3	500 - 750
4	500 - 750
5	750 - 1,000

(6) **DESIGN OF OTHER TREATMENT TANKS.** The design of other treatment tanks shall be considered on an individual basis. A complete description of the method of treatment to be performed in the treatment tank plus three complete sets of plans shall be submitted to the department for each request for approval of the treatment tank. The installation of the tank shall be commenced only upon receipt of written approval by the department. The capacity, sizing and installation of the tank shall be according to subs. (3) and (4) unless the department specifies different sizing or installation requirements in its written approval of the treatment tank. The department may require such treatment tanks to be preceded by a conventional septic tank. Credit will be given for the capacity of the septic tank in meeting the required capacity as listed in sub. (3).

History: Cr. Register, December, 1980, No. 300, eff. 1-1-81.

H 63.16 Maintenance and sludge disposal. (1) **MAINTENANCE.** Septic tanks and other treatment tanks shall be cleaned whenever the sludge and scum occupies $\frac{1}{2}$ of the tank's liquid capacity. All sludge, scum, liquid and any other material removed from a private domestic sewage treatment and disposal system is hereafter referred to as sludge.

(2) **SLUDGE DISPOSAL.** See ch. NR 113, Wis. Adm. Code.

(3) **COUNTY OPTION.** Counties may establish a mandatory maintenance program to insure continuing maintenance of private sewage systems.

History: Cr. Register, December, 1980, No. 300, eff. 1-1-81.

H 63.17 Chemical restoration. No products for chemical restoration or chemical restoration procedures for private sewage systems may be used unless approved by the department.

History: Cr. Register, December, 1980, No. 300, eff. 1-1-81.

H 63.18 Holding tanks. (1) **APPROVAL.** The use of holding tank installations will be considered on an individual basis. Plans and appropriate fees must be submitted as required in s. H 63.08 to the department for review of each request to install a holding tank. The department shall have the responsibility for the review and approval of holding tanks when the tanks are located on private property. Where holding tanks are connected to a public collection system and located in the public right-of-way or are owned and pumped by a governmental entity with an easement for access, the bureau of water quality of the department of natural resources shall be responsible for plan review and approval.

(2) **PROHIBITING HOLDING TANKS.** Holding tanks for new construction may be prohibited by county ordinance. If the county allows the use of holding tanks for new construction, then such use may be prohibited by city, village, or town ordinance. If a governmental unit prohibits holding tanks for new construction, then the governmental unit shall provide an appeal procedure to this prohibition. The county board, city council, village board or town board or the designated committee of such governmental unit, may grant variances to their holding tank prohibition. The county, city, village or town shall inform the department in writing of each variance.

(3) **HOLDING TANKS ON PROPERTIES WITH EXISTING BUILDINGS.** When the use of a holding tank becomes the only available alternative for the disposal of sanitary liquid waste for an existing building, local government shall allow the use of a holding tank or condemn the property. The requirements established for use of holding tanks for newly developed properties in this section shall also apply to replacement system uses.

(4) **NEWLY DEVELOPED PROPERTIES.** (a) *General.* A signed agreement between the appropriate city, village or town and the owner guaranteeing the pumping and transporting of the holding tank contents to a disposal site meeting the requirements of ch. NR 113, Wis. Adm. Code, shall be submitted to the department. The agreement shall specify that if the owner does not cause to have the holding tank properly maintained in response to orders from local government or the department, and it becomes necessary to prevent or abate a nuisance as described in ss. 146.13 and 146.14, Stats., local government shall provide for pumping and transporting of the holding tank contents. The agreement shall also include the requirement that a quarterly pumping report be submitted by the owner or their agent to the local government and the county which shall state the owner's name, location of the property on which the holding tank is located, the pumper's name, the dates, volumes pumped and the disposal site. An annual pumping report or the fourth quarter report including a summary of the pumping history of the previous year shall be submitted to the department by local or county government. The agreement shall be binding on the owners, their heirs and assignees and recorded in cognizant with the deed.

(b) **HOLDING TANKS IN SUBDIVISIONS.** The following procedures shall be followed when creating lots by subdividing and using holding tanks and the hauling of waste as the means of liquid waste disposal.

1. A local governmental entity shall be responsible for proper waste hauling. In the case of a township, a sanitary district shall be in existence.

2. The properties to be served shall be described in detail—including plat name.

3. When a private waste hauler is to be used, a contract between local government and the liquid waste hauler shall be submitted to the department. In the case of townships, the sanitary district shall have a contract with the liquid waste hauler.

4. If hauling of the waste is to be performed by local government or a sanitary district, a copy of the action purchasing the hauling equipment and authorization of employees to perform the work shall be submitted to the department.

5. A copy of the contract between the sanitary district or private haulers and a local governmental entity operating the sewage treatment facility receiving the hauled waste shall be submitted to the department if final disposal is accomplished in that manner.

6. A letter from the department of natural resources authorizing disposal into a public treatment facility shall be supplied to the department if final disposal is accomplished in that manner. If disposal is to the ground surface, the department of natural resources shall indicate that the disposal site meets the requirements of NR 113, Wis. Adm. Code.

7. If the subdivision is given clearance under ch. 236, Stats., as a seweraged subdivision, the department of natural resources shall be the approving authority for the holding tank installation.

(5) **SIZING.** (a) *One and 2 family residences.* The minimum liquid capacity of a holding tank for one and 2 family residences is as follows:

Number of Bedrooms	Holding Tank
1	2,000
2	2,000
3	2,000
4	2,500
5	3,000
6	3,500
7	4,000
8	4,500

(b) *Public buildings.* Public buildings shall have a minimum 5-day holding capacity, but not less 2,000 gallons. Sizing shall be based in accord with s. H 63.15 (3) (c) 2. The 750 gallon minimum referred to in s. H 63.15 (3) does not apply to holding tanks. No more than 4 holding tanks installed in series will be permitted.

(6) **CONSTRUCTION.** Holding tanks shall be constructed of welded steel, monolithic concrete, glass-fibre reinforced polyester or other materials approved by the department.

(7) **INSTALLATION.** (a) *Location.* Tanks shall be located in accord with s. H 63.15 (4) (a), except the tanks shall be at least 20 feet from any part of a building. Holding tanks shall be so located to an all-weather access road or drive so that the pumper may drive pumping equipment to within 10 feet of the servicing manhole.

(b) *Warning device.* A high water warning device shall be installed so that it activates 1 foot below the inlet pipe. This device shall be either an audible or illuminated alarm. If the latter, it shall be conspicuously mounted. Electrical junction box, including warning equipment junctions, shall be located outside the holding tank unless they are housed in waterproof, explosion-proof enclosures. Electrical relays or controls shall be located outside the holding tank.

(c) *Manholes.* Each tank shall be provided with a manhole opening no less than 24 inches square or 24 inches inside diameter extending to a minimum of 4 inches above ground. Finish grade must be sloped away from the manhole to divert surface water from the manhole. Each man-

hole cover shall have an effective locking device. Manhole covers may have a service port reduced in size to 8 inch inside diameter 4 inches above finish grade level. The reduced opening must have an effective locking cover or a brass cleanout plug. Reduced locking devices or cleanouts must be approved by the department.

(d) *Septic tank.* If an approved septic tank is installed to serve as a holding tank, the inlet and outlet baffle may be removed and the outlet shall be sealed.

(e) *Vent.* Each tank shall be provided with a minimum 2-inch cast iron fresh air inlet extending 12 inches above final grade, terminating with a return bend fitting and 25 feet from a door, window or fresh air inlet. When a 4-inch cast iron vent is used, the above requirements shall apply except it may terminate with an approved vet cap.

(f) *Servicing.* Holding tanks shall be serviced in accord with ch. 146, Stats., and ch. NR 113, Wis. Adm. Code.

(8) **FLOOD PLAIN CONSTRUCTION.** (a) *Vent.* Two feet of freeboard between the top of the vent of the holding tanks and the regional flood elevation is required.

(b) *Manhole.* Two feet of freeboard is required between the top of the service manhole of a holding tank and the regional flood elevation.

(c) *Anchoring.* Adequate anchoring of a holding tank must be provided to counter the buoyant forces in the event of a regional flood.

History: Cr. Register, December, 1980, No. 300, eff. 1-1-81.

H 63.19 Inspection and tests. (1) **INITIAL INSPECTION PROCEDURES.** (a) *General.* All private sewage systems shall be inspected after construction but before backfilling no later than the end of the next workday excluding Saturdays, Sundays and holidays after receiving notice from the licensed plumber responsible for the installation, i.e., the plumber in charge.

(b) *Notice for inspection.* The plumber in charge shall notify the county in person, by telephone or in writing when the private sewage system is ready for inspection.

(c) *Preparation for inspection.* When a private sewage system is ready for inspection, the plumber in charge shall make such arrangements as will enable the county or department inspector to inspect all parts of the system. The plumber shall have present the proper apparatus and equipment for conducting the inspection and shall furnish such assistance as may be necessary in making proper inspection.

(2) **COVERING OF WORK.** No part of the private sewage system may be backfilled until has been inspected and approved. If any part is covered before being inspected and approved it shall be uncovered at the discretion of the county or department inspector.

(3) **OTHER INSPECTIONS.** The county or department may require additional inspections other than the inspection prior to backfilling. Inspections may be required during the construction phase and after backfilling.

(4) **INSPECTIONS FOR ADDITIONS, ALTERATIONS OR MODIFICATIONS.** When a private sewage system is modified, altered or additions constructed, the inspection criteria required in this section shall apply.

(5) **DEFECTS IN MATERIALS AND WORKMANSHIP.** If inspection discloses defective material, design, siting or unworkmanlike construction which does not conform to the requirements of this chapter, the nonconforming parts shall be removed, replaced and reinspected.

History: Cr. Register, December, 1980, No. 300, eff. 1-1-81.

H 63.20 Materials. (1) **MINIMUM STANDARDS.** (a) *Approval.* Unless otherwise provided for in this chapter, all materials, fixtures or devices sold, used or entering into the construction of a private sewage system or parts thereof, shall be submitted to the department for approval and shall conform to approved applicable standards or to other equivalent standards acceptable to the department and shall be free from defects.

(b) *Identification.* Each length of pipe and each pipe fitting, fixture, material and device used in a private sewage system shall have cast, embossed, stamped or indelibly marked on it the maker's mark or name, the weight and quality of the product or identified in accord with the applicable approved standard. All materials and devices used in the construction of a private sewage system or parts thereof shall be marked and identified in a manner satisfactory to the department.

(c) *Conformance.* Standards listed or referred to in this section cover materials which will conform to the requirements of this chapter when used in accordance with the limitations imposed in this or other sections thereof. Designs and materials for special conditions or materials not provided for herein may be used only after the department has been satisfied as to their adequacy and granted approval. Section H 62.19, Wis. Adm. Code, contains generally accepted and department approved plumbing materials and their applicable standards.

(d) *Alterations.* In existing buildings or premises in which plumbing installations are to be altered, repaired or renovated, the department has discretionary powers to permit deviation from the provisions of this chapter provided that such a proposal to deviate is first submitted to the department for proper determination and approval.

(e) *Tests.* The department may require tests to be made or repeated, if at any time, there is reason to believe that any material or device no longer conforms to the requirements on which its approval was based.

(2) **MATERIAL STANDARDS.** Specification standards. Each material listed in Table 32 of s. H 62.19, Wis. Adm. Code, shall conform to at least one of the standards opposite it. Products conforming to one or more of the specifications listed shall be considered acceptable subject to limitations specified. See s. H 63.02 (63) for a list of abbreviations. For materials not listed, consult the department.

(3) **PRECAST CONCRETE AND SITE CONSTRUCTED TANKS.** (a) Precast concrete tanks shall have a minimum wall thickness of 2 inches.

(b) *Materials.* The concrete used in constructing a precast or site-constructed tank shall be a mix to withstand a compressive load at least 3,000 pounds per square inch. All concrete tanks shall be designed to withstand the pressures to which they are subjected.

(c) *Joints.* The floor and sidewalls of a site-constructed concrete tank shall be monolithic except a construction joint will be permitted in the lower 12 inches of the sidewall of the tank. The construction joint shall have a keyway in the lower section of the joint. The width of the keyway shall be approximately 30% of the thickness of the sidewall with a depth equal to the width. A continuous water stop or baffle at least 6 inches in width shall be set vertically in the joint, embedded $\frac{1}{2}$ its width in the concrete below the joint with the remaining width in the concrete above the joint. The water stop or baffle shall be copper, neoprene, rubber or polyvinylchloride designed for this specific purpose. Joints between the concrete septic tank and its cover and between the septic tank cover and manhole riser shall be tongue and groove or shiplap type and sealed watertight using neat cement, mortar or bituminous compound.

(4) **STEEL SEPTIC TANKS.** For general tank design see s. H 63.15. Steel tanks shall be fabricated of new, hot rolled commercial steel. The tanks including cover with rim, inlet and outlet collars and manhole extension collars shall be fabricated with welded joints in such a manner as to provide structural stability and water tightness. Steel tanks shall be coated, inside and outside in compliance with U.L. Standard 70 Bituminous Coated Metal Septic Tanks. Any damage to the bituminous coating shall be repaired by recoating. The gauge of the steel shall be as follows:

SEPTIC TANK CAPACITY

Tank Design

Vertical Cylindrical

500 thru 1,000 gallons	Bottom and sidewalls	14 ga	None
	Cover	12 ga	
	Baffles	12 ga	
1,001 thru 1,250 gallons	Complete tank	10 ga	None
1,251 thru 1,500 gallons	Complete tank	7 ga	None

Horizontal Cylindrical

500 thru 1,000 gallons	Complete tank	13 ga	54" dia
1,001 thru 1,500 gallons	Complete tank	12 ga	64" dia
1,501 thru 2,500 gallons	Complete tank	10 ga	76" dia
2,501 thru 9,000 gallons	Complete tank	7 ga	76" dia
9,001 thru 12,000 gallons	Complete tank	1/4"	None
		plate	
12,001 or more gallons.....	Complete tank	5/16"	None
		plate	

(5) **FIBERGLASS SEPTIC TANKS.** (a) *General.* The following paragraphs apply to septic tanks made of glass-fiber reinforced polyester and intended for use in nonindustrial private sewage systems. For general septic tank design see s. H 63.15. Unless otherwise indicated, the plastic terminology used in this section is in accordance with the definitions given in ASTM Standard D 883.

(b) *Materials.* Septic tanks, covers, baffles, flanges, manholes, etc., shall be made from polyester resins with glass-fiber reinforcement and meet the general design criteria as prescribed in s. H 63.15 (1).

(c) *Resin.* The resin shall be a commercial grade of polyester resin and shall be evaluated as a laminate by tests conducted in accordance with ASTM Standard C 581. Unless otherwise approved by the department the same resin shall be used throughout the laminate.

(d) *Reinforcing material.* The reinforcing material shall be of a suitable commercial grade of glass-fiber (E Glass) treated with a coupling agent, approved by the glass-fiber manufacturer, that will provide a compatible bond between the resin and the glass. Glass-fiber surfacing materials, if used, shall be of a chemical-resistant glass (C glass) bonded with a suitable binder.

(e) *Fillers and pigments.* The resins used shall not contain fillers except as required for viscosity control. Up to 5% by weight of the total resin content of thixotropic agent that will not interfere with visual inspection may be added to the resin for viscosity control. Resins may contain pigments and dyes recognizing that such additions may interfere with visual inspection of laminate quality.

(f) *Laminate.* The laminate shall consist of the following: Primary chemical resistant surface; internal anti-wicking barrier; additional structural reinforcing section if required to meet the properties described in par. (h) and the following table; and exterior surface. (See following sketch.)

1) Primary Chemical-Resistant Surface										
2) Internal Anti-Wicking Barrier										
						To Desired				
						Thickness				
						For Strength				
1)	2)	2)	3)	3)	3)	3)	3)	3)	3)	4)
3) Additional Structural Reinforcing Section										
4) Exterior Surface										

(g) *Primary chemical resistant surface.* This surface shall be between 0.005 and 0.012 inch thick. It shall be a reinforced resin-rich surface. It shall be free from cracks and crazing and have a smooth finish.

(h) *Internal anti-wicking barrier.* Not less than 0.100 inch of chemical resistant laminate next to the inner surface shall be reinforced with not less than 20% or more than 30% by weight of mat or chopped strand.

(i) *Additional structural reinforcing sections.* This layer or body or the laminate shall be of chemically resistant construction suitable for the intended use and providing the additional strength necessary to meet the tensile and flexural requirements. When separate layers such as mat, cloth or woven roving are used, all layers shall be lapped at least one inch. Laps shall be staggered as much as possible. If woven roving or cloth is used, layers of chopped strand glass shall be placed as alternate layers.

(j) *Exterior surface.* This surface shall consist of a chopped strand glass over which shall be applied a resin-rich coating. This resin-rich surface layer shall contain less than 20% of reinforcing material.

(k) *Cut edges.* All cut edges shall be coated with resin so that no glass fibers are exposed and all voids are filled. Structural elements having edges exposed to the chemical environment shall be made with chopped strand glass reinforcement only.

(l) *Wall thickness.* The minimum wall thickness shall be as recommended by the manufacturer but in no case shall it be less than 3/16 inch regardless of operating conditions. Isolated small areas may be as thin as 80% of the specified minimum wall thickness.

(m) *Mechanical properties.* To establish proper wall thickness and other design characteristics, the minimum physical properties for any laminate shall be as shown in the following table and par. (n) below.

REQUIREMENTS FOR PROPERTIES OF NEWLY FABRICATED
REINFORCED POLYESTER LAMINATES

Property at 73.4°F. in psi (MPa) *	Thickness in inches				Test Method
	3/16	1/4	5/16	3/8 & up	
Ultimate tensile strength, min.	9,000 (62)	12,000 (83)	13,500 (93)	15,000 (103)	ASTM D 638
Flexural strength, min.	16,000 (110)	19,000 (131)	20,000 (137)	22,000 (152)	ASTM D 790
Flexural modulus of elasticity (tangent), min.	700,000 (4823)	800,000 (5512)	900,000 (6201)	1,000,000 (6895)	ASTM D 790

* (MPa) mega pascals

(n) *Surface hardness.* The laminate shall have a Barcol hardness of at least 90% of the manufacturer's minimum specified hardness for the cured resins when tested in accordance with ASTM D 2583. This requirement applies to both interior and exterior surfaces.

(o) *Appearance.* The finished laminate shall be as free as commercially practicable from visual defects such as foreign inclusions, dry spots, air bubbles, pinholes, pimples and delamination. The inner surface shall be free from cracks and crazing and have a smooth finish and an average of not more than 2 pits per square foot providing the pits are less than 1/8 inch diameter and not more than 1/32 inch deep and are covered with sufficient resin to avoid exposure of inner surface fabric. Some waviness is permissible provided the surface is smooth and free from pits. Unless otherwise specified, ASTM D 2563 visual acceptance level 3 shall be the minimum standard for acceptance.

(p) *Tank design.* All tanks shall meet the general design criteria as outlined in s. H 63.15 (1) and (2). Horizontal cylindrical tanks standard end enclosed shall be convexed heads with a maximum radius of curvature equal to the tank diameter. Rectangular tanks shall have external ribs to prevent sidewall deflection exceeding 1/2% of span at any location when tested by filling with water.

(q) *Shell joints.* Where tanks are manufactured in sections and joined by use of a laminate bond, the joint shall be glass-fiber reinforced resin at least the thickness of the heaviest section being joined. The reinforcement shall extend on each side of the joint a sufficient distance to

make the joint at least as strong as the tank wall, and shall be not less than the minimum joint widths specified in the following table. The reinforcement shall be applied both inside and out, with the inner reinforcement considered as a corrosion resistant barrier only and not structural material.

MINIMUM TOTAL WIDTHS OF OVERLAYS FOR
REINFORCED-POLYESTER TANK SHELL JOINTS

Tank wall thickness in inches	3/16	1/4	5/16	3/8	7/16	1/2	9/16	5/8	11/16	3/4
Minimum outside overlay width in inches	4	4	5	6	7	8	9	10	11	12
Minimum inside overlay width in inches	4	4	5	5	6	6	6	6	6	6

(r) *Resistance to static load.* There shall be not more than 0.25% difference in dimensions before and after the tanks are statically loaded. For the static load test bed an empty tank in dry sand to a depth not exceeding 4 inches and oriented as in service. Load top segment of empty tank with evenly distributed load to a total weight in pounds equal to:

$$L = 140 \times A_1 \times b \quad \text{where } L = \text{total load}$$

$$A_1 = \text{horizontal cross-sectional area of tank}$$

$$b = \text{depth of overburden expected}$$

Rotate tank through 90° on its major axis. Bed tank in dry sand to a depth not exceeding 4 inches. Load sides of empty tank with evenly distributed load to total weight in pounds equal to:

$$L = 70 \times A_2 \times b \quad \text{where } L = \text{total load}$$

$$A_2 = \text{vertical cross-sectional area of tank}$$

$$b = \text{depth of overburden expected}$$

(s) *Siphoning or pumping.* There shall be no permanent deflection or change in length of any internal or external component of the tank during the pumping or siphoning when the tank is filled to its working level. There shall be no signs of leaking, weeping or other failure.

(t) *Weight.* No tank shall differ in gross weight by more than +10 or -5% from the weight of tanks that have been subjected to the tests for siphoning and static pressure.

(u) *Tests.* Tensile strength test shall be in accordance with ASTM D 638, except that the specimens shall be the actual thickness of the

fabricated article and the width of the reduced section shall be one inch. Other dimensions of specimens shall be as designated by the ASTM standard for type one specimens for materials over ½ inch to one inch inclusive. Specimens shall not be machined on the surface. Test 5 specimens at 0.20 to 0.25 inch/minute crosshead speed, and average the results. Flexural strength shall be determined in accordance with Procedure A and Table 1 of ASTM D 790, except that the specimens shall be actual thickness of the fabricated article and the width shall be one inch. Other dimensions of specimens shall be as designated by the ASTM standard. Specimens shall not be machined on the surface. Test 5 specimens, with the resin-rich side in compression. Determine the tangent modulus of elasticity in flexure by ASTM D 790.

(6) **ALTERNATE AND EXPERIMENTAL MATERIALS.** (a) *Intent.* The provisions of this chapter are not intended to prevent the use of any alternate material provided the material has first been approved and its use authorized by the department.

(b) *Approval.* The department may approve an alternate or experimental material in accord with s. 145.02 (2) (b), Stats., provided the proposed alternate or the experimental concepts are satisfactory and comply with the intent of this chapter.

(c) *Evidence or proof.* The department shall require that sufficient evidence or proof be submitted to substantiate any claims that may be made regarding the sufficiency of any proposed material.

(d) *Tests and standards.* Tests shall be made in accord with approved standards but in the absence of such standards, the department shall specify the test procedure.

(e) *Repeating tests.* The department may require tests to be made or repeated if at any time there is reason to believe that any material no longer conforms to the requirements on which its approval is based.

History: Cr. Register, December, 1980, No. 300, eff. 1-1-81.

H 63.21 Building sewers and drains. (1) **GENERAL.** Building sewers which terminate in a septic tank shall meet the same general criteria as listed in s. H 62.04, Wis. Adm. Code, except where specified in this section. All sanitary or special type drainage systems shall be connected by means of independent connections with a public sewer, approved private interceptor main sewer or private sewage system.

(2) **COVER.** Building sewers which terminate in a septic tank shall not be less than 18 inches from the top of the pipe to finished grade.

(3) **MATERIALS.** All building sewers which terminate in a septic tank shall be constructed of cast iron, vitrified clay, concrete, asbestos cement, plastic or bituminous fiber pipe or other materials approved by the department. The pipe from the septic tank to the soil absorption area shall be constructed of solid wall pipe approved by the department as specified in s. H 62.19, Wis. Adm. Code.

History: Cr. Register, December, 1980, No. 300, eff. 1-1-81.

H 63.22 Alternative private sewage systems. (1) **GENERAL.** Alternative private sewage systems shall be considered acceptable for use when the site, soil and system design criteria specified in s. H 63.23 (1) and 63.14 (1) are met. Their installation shall be limited to the numbers

specified in s. 145.022, Stats. A trial program shall terminate 5 years after the date of the start of a trial program. If the institutional control aspects specified as part of this section prove satisfactory at the end of a 5 year monitoring and assessment period, controlled use shall cease.

Note: The creation of s. 145.022, Stats., by ch. 262 of the laws of 1979 will take effect on July 1, 1980.

(2) **REPLACEMENT SYSTEMS.** (a) *Number.* There shall be no limit on the number of alternative private sewage systems installed as replacements for existing systems that have failed or are failure-prone.

(b) *Failure-prone system.* A failure-prone system shall be a holding tank or privy installed and in use prior to February 1, 1980.

(c) *Verification.* The existence of a failed or failure-prone system shall be verified in writing by the county.

(3) **NEW CONSTRUCTION.** (a) *Limitation.* In accord with s. 145.022, Stats., the number of alternative private sewage systems for new construction installed each calendar year in the state may not exceed 3% of the number of private sewage systems installed during the previous year. The number of alternative private sewage systems installed in any county in a calendar year may not exceed 5% of the total number of alternative private sewage systems allowed in the state for that year.

(b) *Exceptions.* The percent limitations in this section shall not apply to sites for which an approval is issued in the following manner:

1. Applications for approval had been completed and were on file with the department on February 1, 1980.

2. To individual lots for which a sanitary permit was issued under s. H 62.20, Wis. Adm. Code, for a conventional system by the department or local permit issuing authority but later ruled unsuitable due to new or changed soil criteria being established by the department.

3. To one additional second homesite on a farm to be occupied by a parent, child, sibling, grandchild, niece, nephew or first cousin who will be a primary or co-operator of the farm.

4. To lots meeting the site criteria for a conventional private sewage system.

Note: New soil condition criteria promulgated by the department is limited to 1) the existence of soil having a percolation rate of 60 minutes per inch or faster for the depth of the proposed soil absorption system and for 3 feet below the bottom of the system and 2) the presence of a few faint high chroma mottles in some glacial tills or clean sandy soils.

(c) *Verification.* The property owner requesting an exception shall submit a copy of an official document from the county having authority that indicates which exception the property is effected by. The exception shall be reported on forms furnished by the department.

(d) *Applicability.* The limitation, exceptions and verification shall apply to an individual lot and not to the owner of the property. Except for persons applying before February 1, 1980, more than one approval for new construction shall not be issued to any one individual.

(e) *Records.* The department and the county shall maintain an accurate record of the requests for approval received. The record shall include the date received; the property location; the name of the owner,

soil tester and designer; and the type of private sewage system. Requests received over the number allowed in a county or in the state shall be carried over by the county in order to the next year.

(4) **INSTITUTIONAL CONTROLS.** (a) *General.* The institutional controls in effect during previous trial periods as enumerated in this subsection shall be continued for the 5 year controlled use period.

1. **Application.** Application for a mound approval shall be made on a form supplied by the department.

2. **On-site inspection.** Each proposed alternative private sewage system site shall be inspected for soil characteristics and limitations by the department or a county employee certified as a soil tester.

3. **Plans.** a. Plans and specifications prepared in accord with s. H 63.04 (2) (b), Wis. Adm. Code, shall be approved by the department and the appropriate county prior to permit issuance.

b. The approval shall remain in effect for 2 years after the date of approval. Approvals may be renewed. If construction does not commence within the 2 year period and the approval is not renewed, the approval is void and the permit as related to the limitation requirements may be reissued to another individual.

4. **Inspections.** a. Persons responsible for inspecting alternative private sewage systems shall be certified as a plumbing inspector II or III as specified in s. H 61.15, Wis. Adm. Code. Also, they shall have attended a training session relating specifically to mound systems and have received certification of such attendance.

b. Mound systems shall be inspected at the time the ground surface is plowed, while the sand fill is being placed, at the time the distribution piping installation has been completed and after all work has been completed. Other inspections may be necessary dependent upon site conditions or as required in this chapter.

c. A report of each inspection on forms furnished by the department shall be submitted to the department with a copy retained in the county's files.

d. The person or persons making inspections shall submit a statement on forms furnished by the department indicating whether the installation was in accord with the approved plans and specifications within 10 days after the installation work is completed. A copy shall be retained in the county's files.

(b) *Maintenance.* An alternative private sewage system shall be maintained in acceptable working condition at all times with the septic tank pumped in accord with s. H 63.16, Wis. Adm. Code. A report of servicing on forms provided by the department shall be submitted to the department and the appropriate county.

(5) **MONITORING AND EVALUATION.** (a) *General.* The department shall monitor and evaluate the performance of the counties, installers, soil testers and system designers during the trial program for alternative private sewage systems. The results of the evaluations by the department will be used to determine whether each alternative private sewage system will be allowed for general use after the trial program.

(b) *State monitoring.* 1. Site evaluation. Department staff shall randomly field check 10% of the sites and a minimum if possible of 5 per county per year for which plans to construct alternative private sewage systems are received by the department. Comparisons shall be made to the soil test report and the county on-site inspection.

2. Installation evaluation. Department staff shall randomly check 10%, of all alternative private sewage system installations, and a minimum if possible of 5 per county per year to determine if the system was properly constructed.

3. Continuing inspection. Department staff shall visually check as many alternative private sewage systems as possible during the 5 year control period to check for surfacing of effluent.

(c) *County monitoring.* The county shall visually inspect each alternative private sewage system within their jurisdiction a minimum of once every 2 years. The inspection shall consist of checking for surfacing of effluent around the system, ponding of effluent in the bed or trenches and to check the pump, pumping chamber and septic tank.

History: Cr. Register, December, 1980, No. 300, eff. 1-1-81.

H 63.23 Mound systems. (1) **SOIL AND SITE REQUIREMENTS.** (a) *General.* The soil and site factors which effect the suitability of a site for the installation of a mound, on slowly permeable soils with or without high groundwater, shallow permeable soils over pervious bedrock or permeable soils with high groundwater are given in Table 14. The installation of a mound in a floodplain or filled area is prohibited. Removal of the fill material may not make the site suitable. A mound shall not be installed in a compacted area. A mound shall not be installed over a failing conventional system.

Table 14
SOIL AND SITE FACTORS THAT RESTRICT
MOUND SYSTEM INSTALLATION

Restricting Factors	Soil Group		
	Slowly Permeable Soils	Permeable Soils With Pervious Bedrock	Permeable Soils With High Groundwater
Percolation rate	Greater than 60 to 120 min/in	3 to 60 min/in	0 to 60 min/in
Depth to pervious rock	24 in.	24 in.	24 in.
Depth to high groundwater	24 in.	24 in.	24 in.
Depth to impermeable rock strata	60 in.	60 in.	60 in.
Depth to 50% by volume rock fragments	24 in.	24 in.	24 in.

(b) *Soil boring and percolation tests.* A minimum of 3 soil borings shall be conducted in accord with s. H 63.09 to determine depth to seasonal or permanent soil saturation or bedrock. Identification of a replacement system area is not required.

1. Slowly permeable soils with or without high groundwater. Percolation tests shall be conducted at a depth of 20 to 24 inches from existing grade. If a more slowly permeable horizon exists at less than 20 to 24 inches, percolation tests shall be conducted within that horizon. A mound system is suitable for this site condition if the percolation rate is greater than 60 and less than or equal to 120 minutes per inch.

2. Shallow permeable soils over creviced bedrock. Percolation tests shall be conducted at a depth of 12 to 18 inches from existing grade. If a more slowly permeable horizon exists within 12 to 18 inches, percolation tests shall be conducted within that horizon. A mound system is suitable for this site if the percolation rate is between 3 and 60 minutes per inch.

3. Permeable soils with high groundwater. Percolation tests shall be conducted at a depth of 20 to 24 inches from existing grade. If a more slowly permeable horizon exists at less than 20 to 24 inches, percolation tests shall be conducted within that horizon. A mound system is suitable for this site condition if the percolation rate is between 0 and 60 minutes per inch.

(c) *Depth to pervious rock.* There shall be at least 24 inches of unsaturated natural soil over creviced or porous bedrock.

(d) *Depth to high groundwater.* There shall be at least 24 inches of unsaturated natural soil over high groundwater as indicated by soil mottling or direct observation of water in accord with s. H 63.09 (4) (d) and (e).

(e) *Slopes.* 1. Maximum allowable slopes. A mound shall not be installed on a slope which is greater than 6% if the percolation rate is between 30 and 120 minutes per inch. If the percolation rate is 0 to less than 30 minutes per inch, the maximum allowable slope is 12%.

2. Location of mound on sloping sites. The mound shall be located so that the longest dimension of the mound and the distribution lines are perpendicular to the slope. The mound shall be placed upslope and not at the base of a slope. If there is a complex slope (2 directions), the mound should be situated so that the effluent is not concentrated in one direction. Surface water runoff shall be diverted around the mound.

(f) *Depth to rock strata or 50% by volume rock fragments.* There shall be at least 60 inches of soil over uncreviced, impermeable bedrock. If the soil contains 50% coarse fragments by volume in the upper 24 inches, a mound cannot be installed unless there is at least 24 inches of permeable, unsaturated soil that has less than 50% coarse fragments beneath this layer.

(2) MOUND DIMENSIONS AND DESIGN. For residential dwellings and public buildings with estimated wastewater flows less than 600 gallons per day, the mound dimensions in Tables 17 through 28 may be used. The dimensions and corresponding letter designations listed in the tables and referred to in this section are shown in figures 1 through 5. For all buildings with estimated wastewater flows exceeding 600 gallons per day, the mound shall be designed in accord with the calculations specified in pars. (a) through (h).

(a) *Daily wastewater flow.* 1. Residential. The daily wastewater flow shall be estimated as 150 gallons per bedroom per day.

2. Public building. The total daily wastewater flow shall be determined in accord with s. H 63.15 (3) (c) 2.

(b) *Design of the absorption area.* The size of the absorption area is dependent upon the infiltrative capacity of the medium sand texture fill material and the daily wastewater flow. The infiltration rate for the medium sand shall be 1.2 gal/ft²/day. The required absorption area shall be determined by dividing the total wastewater flow by 1.2 gal/ft.

(c) *System configuration.* 1. Trenches. a. For slowly permeable soils with or without high groundwater, the effluent shall be distributed in the mound through a trench system. Trench length should be selected by determining the longest dimension that is perpendicular to any slope on the site. Trench width and trench spacing is dependent on specific site conditions.

b. Trenches shall be 2 to 4 feet in width.

c. The lineal feet of trench required shall be calculated by dividing the required absorption area by the trench width (A). Trench length (B) shall not be more than 100 feet. Where more than one trench is required, the trenches should be of equal length. A mound should not have more than 3 trenches.

d. Trench spacing (C) shall be determined by comparing the estimated wastewater flow, the infiltrative capacity of the natural soil and the trench length (B). Trench spacing (C) shall be calculated as:

Trench spacing

$$(C) = \frac{\text{Estimated wastewater flow} + (0.24 \text{ gal/ft}^2/\text{day})}{\text{Number of trenches}} \div \text{trench length (B)}.$$

The calculated trench spacing (C) shall be measured from center to center of the trenches.

Note: For facilities with more than 1,500 gallons per day that must use a trench system, the department should be contacted prior to system design.

2. Beds. A long, narrow bed design should be used for permeable soils with high water tables. The bed can be square or rectangular for shallow permeable soils over bedrock. The bed length (B) should be set after determining the longest dimension that is available and that is perpendicular to any slope on the site. The bed width (A) shall be determined by dividing the absorption area required by (B).

(d) *Mound dimensions.* 1. Mound height. The mound height consists of the fill depth, the bed or trench depth, the cap and top soil depth.

a. The fill depth (D) shall be at least 1 foot for slowly permeable soils and for permeable soils with high water tables. For shallow permeable soils over bedrock, a minimum of 2 feet of fill is required. If the site is not level, additional fill shall be placed at the downslope end of the bed or trench so that the bottom of the bed or the trenches are level. For bed systems the downslope fill depth (E) = D + (Percentage) (A). For trench systems the downslope fill depth (E) = D + (slope) (C + A).

b. The bed or trench depth (F) shall be at least .75 feet. At least 6 inches of aggregate shall be placed under the distribution pipes and at least 2 inches of aggregate shall be placed over the top of the distribution pipes.

c. The cap and top soil depth (H) at the center of the mound shall be at least 1.5 feet which includes 1 foot of subsoil and 0.5 feet of top soil. At the outer edges of the mound the minimum cap and top soil depth (G) shall be 1 foot which includes 0.5 feet of subsoil and 0.5 feet of top soil. The soil used for the cap can be top soil or finer textured subsoil.

2. Mound length. The total mound length (L) is equal to the bed or trench length plus the end slopes (K).

a. The end slope (K) =
 mound depth at center x 3:1 slope =

$$\frac{[(D + E) + F + H] 3}{2}$$

b. The total mound length (L) =
 (bed or trench length, B) + 2 (end slope, K).

3. Mound width. The total width (W) of a mound with a bed design shall be equal to the upslope width (J), the bed width (A) and the downslope width (I). When a trench design is used, the total width (W) shall be equal to the upslope width (J), the trench width or widths (A), the trench spacing (C) and the downslope width (I). On sloping sites the downslope width (I) shall be greater than the upslope width (J). On level sites the upslope width and the downslope width shall be the same.

a. Upslope width (J) = mound depth at upslope edge x 3:1 slope x slope correction factor from Table 15 =

$$(D + F + G) \times 3 \times \text{correction factor}$$

b. Downslope width (I) = mound depth at downslope edge x 3:1 slope x slope correction factor from Table 15 =

$$(E + F + G) \times 3 \times \text{correction factor}$$

c. The mound width (W) for a bed system =
 upslope width (J) + bed width (A) + downslope width (I).

The mound width (W) for a trench system =
 upslope width (J) + $\frac{\text{trench width (A)}}{2}$ + [(number trenches - 1) x
 $\frac{\text{trench spacing (C)}}{2}$] + $\frac{\text{trench width (A)}}{2}$ + downslope width (I).

Table 15

DOWNSLOPE AND UPSLOPE WIDTH CORRECTIONS FOR MOUNDS
ON SLOPING SITES

Slope %	Downslope Correction Factor	Upslope Correction Factor
0	1.0	1.0
1	1.03	.97
2	1.06	.94
3	1.10	.915
4	1.14	.89
5	1.18	.875
6	1.22	.86
7	1.27	.83
8	1.32	.80
9	1.38	.785
10	1.44	.77
11	1.51	.75
12	1.57	.73

(e) *Basal area.* 1. Minimum basal area required. The minimum basal area required is dependent upon the infiltrative capacity of the natural soil. The infiltrative capacities listed in Table 16 are determined by the percolation rate of the soil. To calculate the minimum required basal area, divide the total daily flow by the appropriate infiltrative capacity of the natural soil.

Table 16

Percolation Rate	Infiltrative Capacity of the Natural Soil
0 to less than 30 min./in.	1.2 gal./ft/day
30 to 60 min./in.	.74 gal./ft/day
greater than 60 to 120 min./in.	.24 gal./ft/day

2. Basal area available, bed. On sloping sites the basal area shall be that area under the bed and downslope of the bed. On level sites the basal area shall be the entire area under the mound excluding the end slope areas. The appropriate equation from one of the following shall be used to determine the available basal area.

Bed length (B) x (bed width (A) + downslope width (I) = basal area available for sloping site

Bed length (B) x total mound width (W) = basal area available for level sites

3. Basal area available, trench. On sloping sites the basal area shall be that area under and downslope of the trenches. On level sites the basal area shall be the total area under the mound excluding the end slope areas. The appropriate equation from one of the following shall be used to determine the available basal area.

$$\text{Trench length (B) } \times \text{ [mound width (W) - (upslope width (J) + } \frac{\text{trench width (A)] = }{2}$$

basal area available for sloping sites

$$\text{Trench length (B) } \times \text{ total mound width (W) = basal area available for level sites}$$

4. Adequacy of basal area. If the basal area available is not equal to or greater than the basal area required, the downslope width (I) on a sloping site shall be increased or the up and downslope widths (J) and (I) on a level site shall be increased until sufficient area is available.

(f) *Distribution system.* The distribution system for mounds for daily flows less than 600 gallons per day may be sized in accord with the applicable criteria in sub. (3) or with s. H 63.14 (3). For all other buildings, the distribution system shall be designed in accord with s. H 63.14 (3).

(g) *Pump selection.* Pump selection shall be based upon the criteria specified in s. H 63.14 (5). See s. H 63.14 (6) for pump and alarm controls and s. H 63.15 (5) (b) for dosing chamber capacity and all other applicable requirements.

(h) *Dose volume.* The dose volume for daily flows less than 600 gallons per day may be sized in accord with the applicable criteria in H 63.14 (6). The dose volume for systems in excess of 600 gallons per day shall be sized in accord with ss. H 63.14 and 63.15 (3) (c) 2.

(3) DESIGN CRITERIA FOR 3 SITE CONDITIONS FOR TOTAL DAILY WASTEWATER FLOWS WHICH ARE LESS THAN OR EQUAL TO 600 GALLONS. The following tables and diagrams may be used for sizing and designing mounds for one and 2 family residences.

Table 17

**DESIGN CRITERIA FOR A MOUND FOR A 1 BEDROOM HOME
ON 0 TO 6% SLOPE WITH LOADING RATES UP TO 150 GAL/DAY
FOR SLOWLY PERMEABLE SOIL**

PARAMETER	SYMBOL	UNITS	SLOPE %			
			0	2	4	6
Trench Width	A	Ft	3	3	3	3
Trench Length	B	Ft	42	42	42	42
No. of Trenches	---	---	1	1	1	1
Mound Height	D	Ft	1	1	1	1
	F	Ft	0.75	0.75	0.75	0.75
	G	Ft	1	1	1	1
	H	Ft	1.5	1.5	1.5	1.5
Mound Width	J	Ft	11 *	8	8	8
	I *	Ft	11	15	15	15
	W	Ft	25	26	26	26
Mound Length	K	Ft	10	10	10	10
	L	Ft	62	62	62	62
Dist. Pipe Length	P	Ft	20.	20.	20.	20.
Dist. Pipe Diameter	---	In	1	1	1	1
No. of Holes per						
Dist. Pipe**	---	---	9	9	9	9
Hole Spacing*	---	In	30	30	30	30
Hole Diameter**	---	In	1/4	1/4	1/4	1/4

* Additional width to obtain required basal area

** Last hole is located at end of dist. pipe which is 15" from other hole

Table 18

**DESIGN CRITERIA FOR A MOUND FOR A 2 BEDROOM HOME
ON 0 to 6% SLOPE WITH LOADING RATES TO 300 GAL/DAY
FOR SLOWLY PERMEABLE SOIL**

PARAMETER	SYMBOL	UNITS	SLOPE %			
			0	2	4	6
Trench Width	A	Ft	3	3	3	3
Trench Length	B	Ft	42	42	42	42
No. of Trenches	—	—	2	2	2	2
Trench Spacing	C	Ft	15	15	15	15
Mound Height	D	Ft	1	1	1	1
	E	Ft	1	1.4	1.7	2.1
	F	Ft	0.75	0.75	0.75	0.75
	G	Ft	1	1	1	1
	H	Ft	1.5	1.5	1.5	1.5
Mound Width	J	Ft	12	8	8	8
	I*	Ft	12	20	20	20
	W	Ft	42	46	46	46
Mound Length	K	Ft	10	10	10	10
	L	Ft	62	62	62	62
Dist. Pipe Length	P	Ft	20	20	20	20
Dist. Pipe Diameter	—	In	1	1	1	1
No. of Holes per Dist. Pipe**	—	—	9	9	9	9
Hole Spacing**	—	In	30	30	30	30
Hole Diameter	—	In	1/4	1/4	1/4	1/4
Manifold Length	R	Ft	15	15	15	15
Manifold Diameter***	—	In	2	2	2	2

* Additional width to obtain required basal area

** Last hole is located at end of dist. pipe which is 15" from other hole

*** Diameter dependent upon size of pipe from pump and inlet position

Table 19

**DESIGN CRITERIA FOR A MOUND FOR A 3 BEDROOM HOME
ON A 0 to 6% SLOPE WITH LOADING RATES OF 450 GAL/DAY
FOR SLOWLY PERMEABLE SOILS**

PARAMETER	SYMBOL	UNITS	SLOPE %			
			0	2	3	4
Trench Width	A	Ft	3	3	3	3
Trench Length	B	Ft	63	63	63	63
No. of Trenches	—	—	2	2	2	2
Trench Spacing	C	Ft	15	15	15	15
Mound Height	D	Ft	1	1	1	1
	E	Ft	1	1.4	1.7	2.1
	F	Ft	0.75	0.75	0.75	0.75
	G	Ft	1	1	1	1
	H	Ft	1.5	1.5	1.5	1.5
Mound Width	J	Ft	12 *	8	8	8
	I*	Ft	12	20	20	20
	W	Ft	42	46	46	46
Mound Length	K	Ft	10	10	10	10
	L	Ft	83	83	83	83
Dist. Pipe Length	P	Ft	31	31	31	31
Dist. Pipe Diameter	—	In	1-1/4	1-1/4	1-1/4	1-1/4
No. of Holes per Dist. Pipe**	—	—	13	13	13	13
Hole Spacing*	—	In	30	30	30	30
Hole Diameter	—	In	1/4	1/4	1/4	1/4
Manifold Length	R	Ft	15	15	15	15
Manifold Diameter***	—	In	2	2	2	2

* Additional width to obtain required basal area

** First hole is located 12" from the manifold

*** Diameter dependent upon size of pipe from pump and inlet position

Table 20

**DESIGN CRITERIA FOR A MOUND FOR A 4 BEDROOM HOME
ON A 0 to 6% SLOPE WITH LOADING RATES OF 600 GAL/DAY
FOR SLOWLY PERMEABLE SOILS**

PARAMETER	SYMBOL	UNITS	SLOPE %			
			0	2	4	6
Trench Width	A	Ft	3	3	3	3
Trench Length	B	Ft	56	56	56	56
No. of Trenches	—	—	3	3	3	3
Trench Spacing	C	Ft	15	15	15	15
Mound Height	D	Ft	1	1	1	1
	E	Ft	1	1.7	2.3	3.0
	F	Ft	0.75	0.75	0.75	0.75
	G	Ft	1	1	1	1
	H	Ft	2	2	2	2
Mound Width	J	Ft	12*	8	8	8
	I*	Ft	12	20	20	20
	W	Ft	57	61	61	61
Mound Length	K	Ft	12	12	12	14
	L	Ft	80	80	80	84
Dist. Pipe Length	P	Ft	27.5	27.5	27.5	27.5
Dist. Pipe Diameter	—	In	1-1/4	1-1/4	1-1/4	1-1/4
No. of Holes per Dist. Pipe**	—	—	12	12	12	12
Hole Spacing**	—	In	30	30	30	30
Hole Diameter	—	In	1/4	1/4	1/4	1/4
Manifold Length	R	Ft	30	30	30	30
Manifold Diameter***	—	In	2	2	2	2

* Additional width to obtain required basal area

** Last hole is located at end of dist. pipe which is 15" from previous hole

*** Diameter dependent upon size of pipe from pump and inlet position

Table 21

**DESIGN CRITERIA FOR A 1 BEDROOM HOME FOR A MOUND ON
0 TO 12% SLOPE WITH LOADING RATES UP TO 150 GAL/DAY
FOR SHALLOW PERMEABLE SOIL OVER CREVICED BEDROCK**

PARAMETER	SYMBOL	UNITS	PERCOLATION RATE MIN/IN							
			3 to 60				3 to less than 30			
Slope	—	%	0	2	4	6	8	10 ²	12 ²	
Bed Width	A ⁴	Ft	10	10	10	10	10	10	10	
Bed Length	B	Ft	13	13	13	13	13	13	13	
Mound Height	D	Ft	2	2	2	2	2	2	2	
	E	Ft	2	2.2	2.4	2.6	2.8	3.0	3.2	
	F	Ft	.75	.75	.75	.75	.75	.75	.75	
	G	Ft	1	1	1	1	1	1	1	
	H	Ft	1.5	1.5	1.5	1.5	1.5	1.5	1.5	
Mound Width	J	Ft	12	11	10	10	9	9	9	
	I	Ft	12	13	14	17	18	21	26	
	W	Ft	34	34	34	37	37	41	45	
Mound Length	K	Ft	12	12	12	13	13	13	15	
	L	Ft	37	37	37	39	39	39	43	
Dist. Pipe Length	P ³	Ft	12.5	12.5	12.5	12.5	12.5	12.5	12.5	
Dist. Pipe Diameter	—	In	1	1	1	1	1	1	1	
No. of Dist. Pipes	—	—	6	6	6	6	6	6	6	
Dist. Pipe Spacing	S	Ft	3	3	3	3	3	3	3	
No. of Holes per Dist. Pipe ¹	—	Ft	6	6	6	6	6	6	6	
Hole Spacing ¹	—	In	30	30	30	30	30	30	30	
Hole Diameter	—	In	1/4	1/4	1/4	1/4	1/4	1/4	1/4	
Manifold Length	R	Ft	6	6	6	6	6	6	6	
Manifold Diameter	—	In	2	2	2	2	2	2	2	

1 Last hole is located at end of dist. pipe which is 15" from previous hole.

2 On sites with 10-12% slope, the fill depth D may be reduced to 1.5 ft or the bed width may be reduced so E isn't so great.

3 Use a manifold with dist. pipes only on one side.

4 Beds can be any desired width.

Table 22

DESIGN CRITERIA FOR A 2 BEDROOM HOME FOR A MOUND ON
0 TO 12% SLOPE WITH LOADING RATES UP TO 300 GAL/DAY
FOR SHALLOW PERMEABLE SOIL OVER CREVICED BEDROCK

PARAMETER	SYMBOL	UNITS	PERCOLATION RATE MIN/IN							
			3 to 60				3 to less than 30			
Slope	—	%	0	2	4	6	8	10 ²	12 ²	
Bed Width	A ⁴	Ft	10	10	10	10	10	10	10	
Bed Length	B	Ft	25	25	25	25	25	25	25	
Mound Height	D	Ft	2	2	2	2	2	2	2	
	E	Ft	2	2.2	2.4	2.6	2.8	3.0	3.2	
	F	Ft	.75	.75	.75	.75	.75	.75	.75	
	G	Ft	1	1	1	1	1	1	1	
	H	Ft	1.5	1.5	1.5	1.5	1.5	1.5	1.5	
Mound Width	J	Ft	12	11	10	10	9	9	9	
	I	Ft	12	13	14	17	18	21	26	
	W	Ft	34	34	34	37	37	41	45	
Mound Length	K	Ft	12	12	12	13	13	13	15	
	L	Ft	49	49	49	51	51	51	55	
Dist. Pipe Length	P ³	Ft	12	12	12	12	12	12	12	
Dist. Pipe Diameter	—	In	1	1	1	1	1	1	1	
No. of Dist. Pipes	—	—	6	6	6	6	6	6	6	
Dist. Pipe Spacing	S	Ft	3	3	3	3	3	3	3	
No. of Holes per Dist. Pipe ¹	—	—	5	5	5	5	5	5	5	
Hole Spacing ¹	—	In	30	30	30	30	30	30	30	
Hole Diameter	—	In	1/4	1/4	1/4	1/4	1/4	1/4	1/4	
Manifold Length	R	Ft	6	6	6	6	6	6	6	
Manifold Diameter	—	In	2	2	2	2	2	2	2	

1 Last hole is located 9" from end of dist. pipe.

2 On sites with 10-12% slope, the fill depth D may be reduced to 1.5 ft or the bed width may be reduced so E isn't so great.

3 This design is based on a manifold with dist. pipes on both sides. It could be designed using 24 ft. dist. pipes with manifold at end.

4 Beds can be any desired width.

Table 23

**DESIGN CRITERIA FOR A 3 BEDROOM HOME FOR A MOUND ON
0 TO 12% SLOPE WITH LOADING RATES UP TO 450 GAL/DAY
FOR SHALLOW PERMEABLE SOIL OVER CREVICED BEDROCK**

PARAMETER	SYMBOL	UNITS	PERCOLATION RATE MIN/IN							
			3 to 60				3 to less than 30			
Slope	—	%	0	2	4	6	8	10 ²	12 ²	
Bed Width	A ⁴	Ft	10	10	10	10	10	10	10	
Bed Length	B	Ft	38	38	38	38	38	38	38	
Mound Height	D	Ft	2	2	2	2	2	2	2	
	E	Ft	2	2.2	2.4	2.6	2.8	3.0	3.2	
	F	Ft	.75	.75	.75	.75	.75	.75	.75	
	G	Ft	1	1	1	1	1	1	1	
	H	Ft	1.5	1.5	1.5	1.5	1.5	1.5	1.5	
Mound Width	J	Ft	12	11	10	10	9	9	9	
	I	Ft	12	13	14	17	18	21	26	
	W	Ft	34	34	34	37	37	41	45	
Mound Length	K	Ft	12	12	12	13	13	13	15	
	L	Ft	62	62	62	64	64	64	68	
Dist. Pipe Length	P ³	Ft	18.5	18.5	18.5	18.5	18.5	18.5	18.5	
Dist. Pipe Diameter	—	In	1	1	1	1	1	1	1	
No. of Dist. Pipes	—	—	6	6	6	6	6	6	6	
Dist. Pipe Spacing	S	Ft	3	3	3	3	3	3	3	
No. of Holes per Dist. Pipe ¹	—	—	8	8	8	8	8	8	8	
Hole Spacing ¹	—	In	30	30	30	30	30	30	30	
Hole Diameter	—	In	¼	¼	¼	¼	¼	¼	¼	
Manifold Length	R	Ft	6	6	6	6	6	6	6	
Manifold Diameter	—	In	2	2	2	2	2	2	2	

1 Last hole is located at end of dist. pipe which is 27" from previous hole.

2 On sites with 10-12% slope, the fill depth D may be reduced to 1.5 ft or the bed width may be reduced so E isn't so great.

3 Use a manifold with dist. pipes only on one side.

4 Beds can be any desired width.

Table 24

DESIGN CRITERIA FOR A 4 BEDROOM HOME FOR A MOUND ON
0 TO 12% SLOPE WITH LOADING RATES UP TO 600 GAL/DAY
FOR SHALLOW PERMEABLE SOIL OVER CREVICED BEDROCK

PARAMETER	SYMBOL	UNITS	PERCOLATION RATE MIN/IN							
			3 to 60				3 to less than 30			
Slope	—	%	0	2	4	6	8	10 ²	12 ²	
Bed Width	A ⁴	Ft	10	10	10	10	10	10	10	
Bed Length	B	Ft	50	50	50	50	50	50	50	
Mound Height	D	Ft	2	2	2	2	2	2	2	
	E	Ft	2	2.2	2.4	2.6	2.8	3.0	3.2	
	F	Ft	.75	.75	.75	.75	.75	.75	.75	
	G	Ft	1	1	1	1	1	1	1	
	H	Ft	1.5	1.5	1.5	1.5	1.5	1.5	1.5	
Mound Width	J	Ft	12	11	10	10	9	9	9	
	I	Ft	12	13	14	17	18	21	26	
	W	Ft	34	34	34	37	37	41	45	
Mound Length	K	Ft	12	12	12	13	13	13	15	
	L	Ft	74	74	74	76	76	76	78	
Dist. Pipe Length	p ³	Ft	24.5	24.5	24.5	24.5	24.5	24.5	24.5	
Dist. Pipe Diameter	—	In	1	1	1	1	1	1	1	
No. of Dist. Pipes	—	—	6	6	6	6	6	6	6	
Dist. Pipe Spacing	S	Ft	3	3	3	3	3	3	3	
No. of Holes per Dist. Pipe ¹	—	—	10	10	10	10	10	10	10	
Hole Spacing ¹	—	In	30	30	30	30	30	30	30	
Hole Diameter	—	In	¼	¼	¼	¼	¼	¼	¼	
Manifold Length	R	Ft	6	6	6	6	6	6	6	
Manifold Diameter	—	In	2	2	2	2	2	2	2	

1 Last hole is located 9" from end of dist. pipe.

2 On sites with 10-12% slope, the fill depth D may be reduced to 1.5 ft or the bed width may be reduced so E isn't so great.

3 Use a manifold with dist. pipes only on one side.

4 Beds can be any desired width.

Table 25

**DESIGN CRITERIA FOR A MOUND FOR A 1 BEDROOM HOME ON
0-12% SLOPE FOR LOADING RATES OF 150 GAL/DAY
FOR PERMEABLE SOIL WITH HIGH WATER TABLE**

PARAMETER	SYMBOL	UNITS	PERCOLATION RATE MIN/IN							
			0 to 60				0 to less than 30			
Slope	—	%	0	2	4	6	8	10	12	
Bed Width	A	Ft	4	4	4	4	4	4	4	
Bed Length	B	Ft	32	32	32	32	32	32	32	
Mound Height	D	Ft	1	1	1	1	1	1	1	
	E	Ft	1	1.1	1.2	1.2	1.3	1.4	1.5	
	F	Ft	.75	.75	.75	.75	.75	.75	.75	
	G	Ft	1	1	1	1	1	1	1	
	H	Ft	1.5	1.5	1.5	1.5	1.5	1.5	1.5	
Mound Width	J	Ft	9	9	8	8	7	7	6	
	I	Ft	9	10	11	12	13	14	15	
	W	Ft	22	23	23	24	24	25	25	
Mound Length	K	Ft	10	10	10	10	10	11	11	
	L	Ft	52	52	52	52	52	53	53	
Dist. Pipe Length	P	Ft	15.5	15.5	15.5	15.5	15.5	15.5	15.5	
Dist. Pipe Diameter	—	In	1	1	1	1	1	1	1	
No. of Dist. Pipes	—	—	2	2	2	2	2	2	2	
No. of Holes per Dist. Pipe*	—	—	7	7	7	7	7	7	7	
Hole Spacing*	—	In	30	30	30	30	30	30	30	
Hole Diameter	—	In	1/4	1/4	1/4	1/4	1/4	1/4	1/4	

* Last hole is located at end of dist. pipe which is 21" from previous hole.

Table 26

**DESIGN CRITERIA FOR A MOUND FOR A 2 BEDROOM HOME ON
0-12% SLOPE FOR LOADING RATES OF 300 GAL/DAY
FOR PERMEABLE SOIL WITH HIGH WATER TABLE**

PARAMETER	SYMBOL	UNITS	PERCOLATION RATE MIN/IN							
			0 to 60				0 to less than 30			
Slope	—	%	0	2	4	6	8	10	12	
Bed Width	A	Ft	6	6	6	6	6	6	6	
Bed Length	B	Ft	42	42	42	42	42	42	42	
Mound Height	D	Ft	1	1	1	1	1	1	1	
	E	Ft	1	1.1	1.2	1.4	1.5	1.6	1.8	
	F	Ft	.75	.75	.75	.75	.75	.75	.75	
	G	Ft	1	1	1	1	1	1	1	
	H	Ft	1.5	1.5	1.5	1.5	1.5	1.5	1.5	
Mound Width	J	Ft	9	9	8	8	7	7	6	
	I	Ft	9	10	11	12	13	15	17	
	W	Ft	24	25	25	26	26	28	29	
Mound Length	K	Ft	10	10	10	10	10	11	11	
	L	Ft	62	62	62	62	62	64	64	
Dist. Pipe Length	p3	Ft	20	20	20	20	20	20	20	
Dist. Pipe Diameter	—	In	1	1	1	1	1	1	1	
No. of Dist. Pipes	—	—	4	4	4	4	4	4	4	
Dist. Pipe Spacing	S	Ft	3	3	3	3	3	3	3	
No. of Holes per Dist. Pipe ¹	—	Ft	9	9	9	9	9	9	9	
Hole Spacing ¹	—	In	30	30	30	30	30	30	30	
Hole Diameter	—	In	1/4	1/4	1/4	1/4	1/4	1/4	1/4	
Manifold Length	R	Ft	3	3	3	3	3	3	3	
Manifold Diameter	—	In	2	2	2	2	2	2	2	

* Last hole is located at end of dist. pipe which is 15" from previous hole.

Table 27

DESIGN CRITERIA FOR A MOUND FOR A 3 BEDROOM HOME ON
0-12% SLOPE FOR LOADING RATE OF 450 GAL/DAY
FOR PERMEABLE SOIL WITH HIGH WATER TABLE

PARAMETER	SYMBOL	UNITS	PERCOLATION RATE MIN/IN							
			0 to 60				0 to less than 30			
Slope	—	%	0	2	4	6	8	10	12	
Bed Width	A	Ft	8	8	8	8	8	8	8	
Bed Length	B	Ft	47	47	47	47	47	47	47	
Mound Height	D	Ft	1	1	1	1	1	1	1	
	E	Ft	1	1.2	1.3	1.5	1.6	1.8	2.0	
	F	Ft	.75	.75	.75	.75	.75	.75	.75	
	G	Ft	1	1	1	1	1	1	1	
	H	Ft	1.5	1.5	1.5	1.5	1.5	1.5	1.5	
Mound Width	J	Ft	9	9	8	8	7	7	6	
	I	Ft	9	11	12	13	15	17	18	
	W	Ft	26	28	28	29	30	32	32	
Mound Length	K	Ft	10	10	10	10	11	11	12	
	L	Ft	67	67	67	67	69	69	71	
Dist. Pipe Length	P	Ft	23	23	23	23	23	23	23	
Dist. Pipe Diameter	—	In	1	1	1	1	1	1	1	
No. of Dist. Pipes	—	—	6	6	6	6	6	6	6	
Dist. Pipe Spacing	S	In	32	32	32	32	32	32	32	
No. of Holes per Dist. Pipe*	—	—	10	10	10	10	10	10	10	
Hole Spacing*	—	In	30	30	30	30	30	30	30	
Hole Diameter	—	In	1/4	1/4	1/4	1/4	1/4	1/4	1/4	
Manifold Length	R	In	64	64	64	64	64	64	64	
Manifold Diameter	—	In	2	2	2	2	2	2	2	

* Last hole is located at end of dist. pipe which is 21" from previous hole.

Table 28

DESIGN CRITERIA FOR A MOUND FOR A 4 BEDROOM HOME ON
0-12% SLOPE FOR LOADING RATE OF 600 GAL/DAY
FOR PERMEABLE SOIL WITH HIGH WATER TABLE

PARAMETER	SYMBOL	UNITS	PERCOLATION RATE MIN/IN							
			0 to 60				0 to less than 30			
Slope	—	%	0	2	4	6	8	10	12	
Bed Width	A	Ft	10	10	10	10	10	10	10	
Bed Length	B	Ft	50	50	50	50	50	50	50	
Mound Height	D	Ft	1	1	1	1	1	1	1	
	E	Ft	1	1.2	1.4	1.6	1.8	2	2.2	
	F	Ft	.75	.75	.75	.75	.75	.75	.75	
	G	Ft	1	1	1	1	1	1	1	
	H	Ft	1.5	1.5	1.5	1.5	1.5	1.5	1.5	
Mound Width	J	Ft	9	8	8	8	7	7	6	
	I	Ft	9	11	13	14	17	18	19	
	W	Ft	28	29	31	32	34	35	35	
Mound Length	K	Ft	10	10	10	10	11	11	12	
	L	Ft	70	70	70	70	72	72	74	
Dist. Pipe Length	P	Ft	24.5	24.5	24.5	24.5	24.5	24.5	24.5	
Dist. Pipe Diameter	—	In	1	1	1	1	1	1	1	
No. of Dist. Pipes	—	—	6	6	6	6	6	6	6	
Dist. Pipe Spacing	S	Ft	3	3	3	3	3	3	3	
No. of Holes per Dist. Pipe*	—	—	10	10	10	10	10	10	10	
Hole Spacing*	—	In	30	30	30	30	30	30	30	
Hole Diameter	—	In	1/4	1/4	1/4	1/4	1/4	1/4	1/4	
Manifold Length	R	Ft	6	6	6	6	6	6	6	
Manifold Diameter	—	In	2	2	2	2	2	2	2	

* Last hole is 9" from end of dist. pipe.

Figure 1

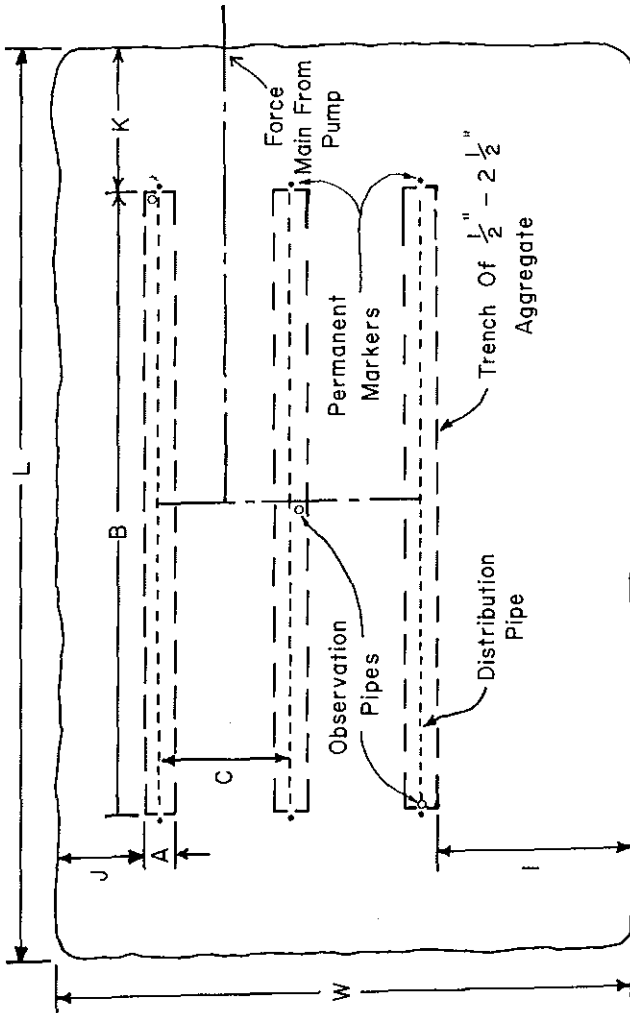

Mound Using 3 Trenches For Absorption Area

Figure 2

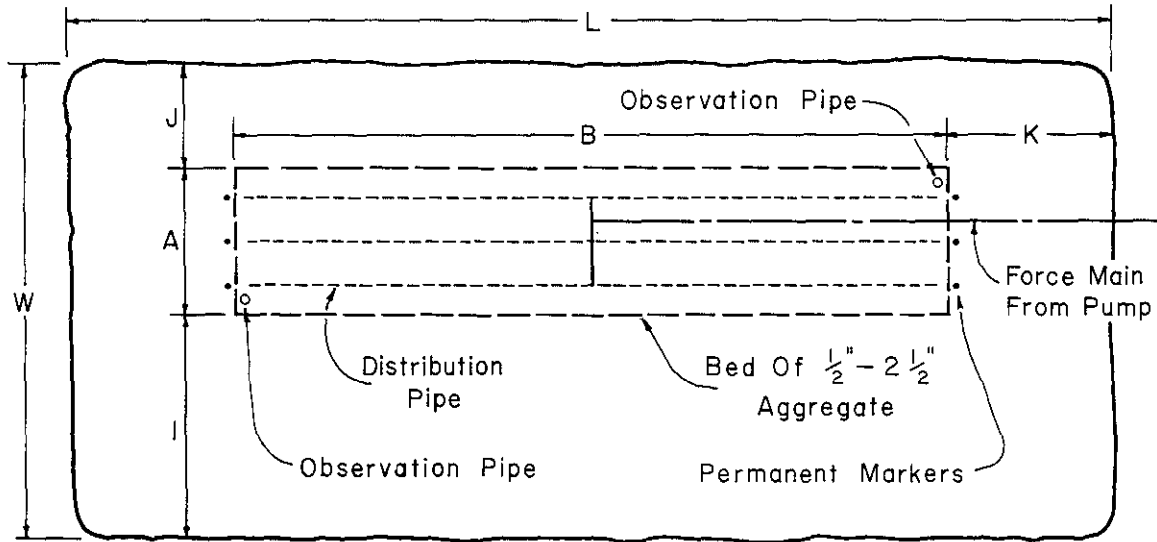

Plan View Of Mound Using A Bed For The Absorption Area

Figure 3

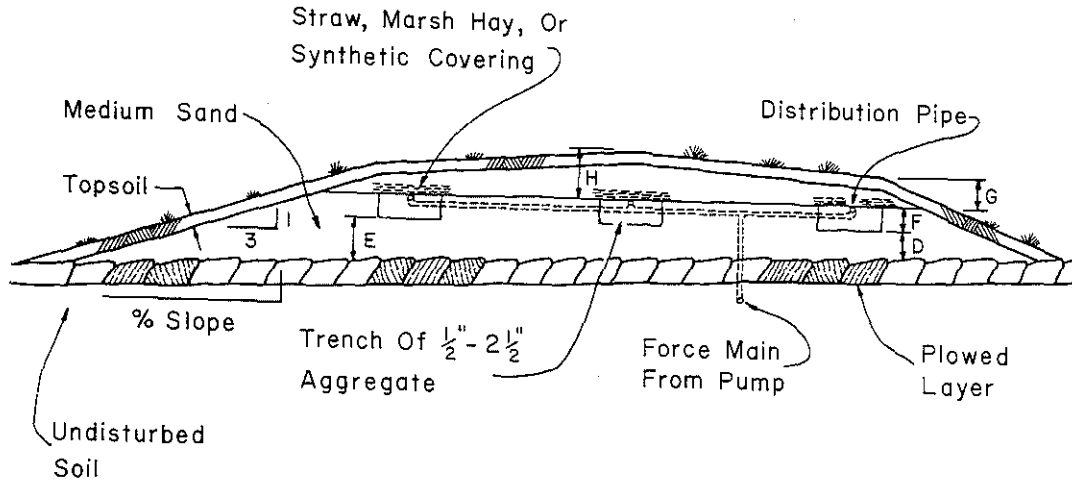

Cross Section Of A Mound System Using
3 Trenches For The Absorption Area

Figure 4

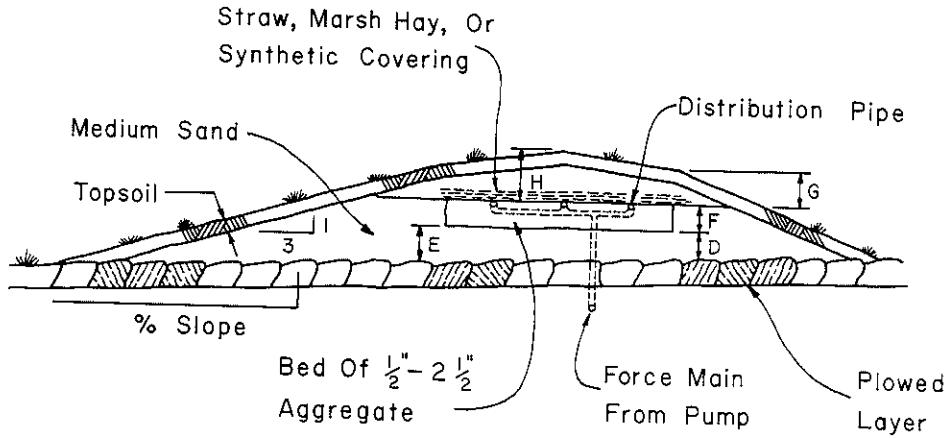

Cross Section Of A Mound System Using
A Bed For The Absorption Area

Perforated Pipe Detail

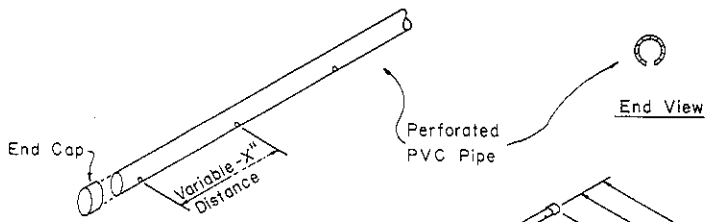

Holes Located On Bottom,
Are Equally Spaced

Distribution Pipe Layout

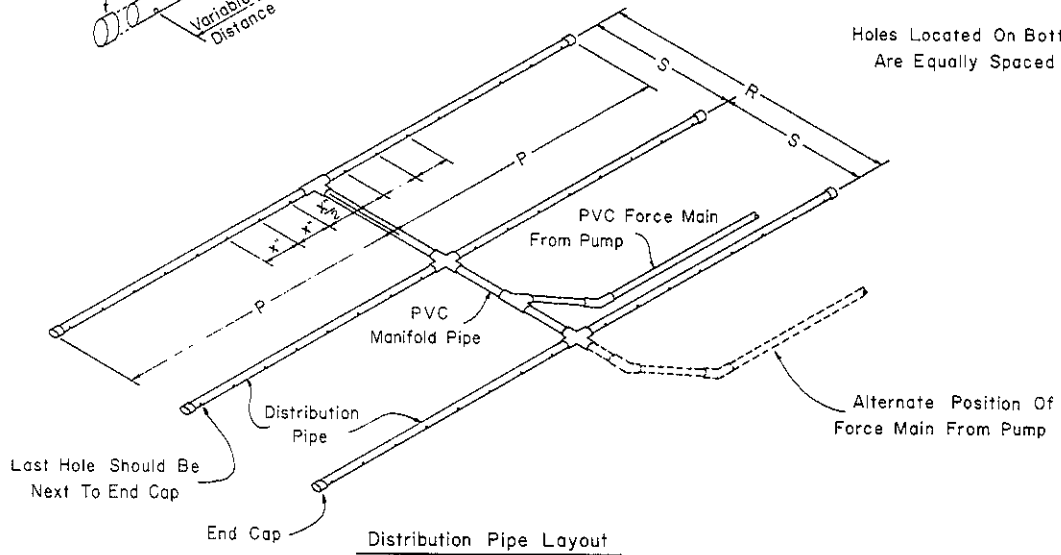

(4) **CONSTRUCTION TECHNIQUES.** Construction shall not commence if the soil is too wet. The soil is too wet for construction if at any level to a depth of 8 inches a soil wire can be formed by rolling the soil between the hands. Installation of mound systems when the soil on the site is frozen is prohibited for new construction.

(a) *Site preparation.* 1. Excess vegetation. Excess vegetation shall be cut and removed from the area of the mound. Small trees shall be cut to grade surface leaving the stumps in place.

2. Force main. The force main from the pumping chamber shall be installed before the mound site is plowed. The force main should be sloped uniformly towards the pumping chamber so that it drains after each dose.

3. Plowing. The site shall be plowed with a mold board plow or chisel plow. The site shall be plowed to a depth of 7 to 8 inches with the plowing perpendicular to the slope. Rototillers shall not be used. The sand fill shall be placed immediately after plowing. After plowing, all foot and vehicular traffic shall be kept off the plowed area.

(b) *Sand fill material.* 1. Fill quality. The fill material shall be medium sand texture which is defined as 25% or more very coarse, coarse and medium sand and less than 50% fine and very fine sand. The percentage of soil plus $1\frac{1}{2}$ times the percentage of clay shall not exceed 15%. Fill materials with higher contents of silt and clay shall not be used.

2. Placement of sand fill. The medium sand fill shall be moved into place from the upslope and side edges of the plowed area. Vehicular traffic is prohibited in the area extending to 25 feet beyond the downslope edge of the mound. The sand fill shall be moved into place with a track-type tractor. A minimum of 6 inches of sand shall be kept beneath the tracks at all times.

3. Installation of the absorption area. Form the bed or trenches within the sand fill. The bottom of the trenches or bed shall be level. The elevation of the bottom of the trenches or bed shall be checked at the upslope and downslope edges to make certain that the fill has been placed to the proper depth.

4. Placement of the aggregate. A minimum of 6 inches of coarse aggregate ranging in size from $\frac{1}{2}$ inch to $2\frac{1}{2}$ inches shall be placed in the bed or trench excavation. The top of the aggregate shall be level.

5. Distribution system. Place the distribution system on the aggregate with the holes on the bottom of the distribution lines.

6. Cover. The top of the bed or trenches shall be covered with a minimum of 2 inches of aggregate ranging in size from $\frac{1}{2}$ inch to $2\frac{1}{2}$ inches. A minimum of 4 to 5 inches of uncompacted straw or marsh hay, or synthetic fabric approved by the department shall be placed over the aggregate. The cap and top soil cover shall be placed. The mound shall be seeded immediately and protected from erosion.

7. Maintenance. Maintenance shall be performed in accord with s. H 63.16 (1), Wis. Adm. Code. When the septic tank is pumped the pump

chamber shall be inspected and shall be pumped to remove any solids if present. Excess traffic in the mound area shall be avoided.

History: Cr. Register, December, 1980, No. 300, eff. 1-1-81.

H 63.24 Severability. Should any section, paragraph, phrase, sentence, clause or word of this chapter be declared invalid or unconstitutional for any reason, the remainder of this chapter shall not be affected thereby.

History: Cr. Register, December, 1980, No. 300, eff. 1-1-81.