

Chapter PSC 114

WISCONSIN STATE ELECTRICAL CODE, VOLUME 1

Subchapter I — Administration and Enforcement

PSC 114.001	General information.
PSC 114.002	Purpose and scope.
PSC 114.003	Authority and statutory references.

Subchapter II — General Requirements

PSC 114.004	General requirements.
PSC 114.005	Application of rules.
PSC 114.006	Adoption of standard by reference.

Subchapter III — Omissions, Changes or Additions to NESC—1997

PSC 114.007	Omissions, changes, additions to NESC—1997.
PSC 114.010	Omissions [NESC 010 through 016, pp. 1–2].
PSC 114.02	Definitions [NESC Section 2, p. 4].
PSC 114.03	References [NESC, p. 14].
PSC 114.094	Grounding methods for electric supply and communication facilities [NESC 94B4, pp. 21–22] (Section 9).
PSC 114.096	Multi-grounded systems [NESC 96C, p. 23].
PSC 114.097	Separation of grounding conductors [NESC 97C, p. 24].
PSC 114.097D2	Multi-grounded systems [NESC 97D2, p. 24].
PSC 114.127	Classified locations [NESC 127, pp. 45 and 46].
PSC 114.202	Application of rules [NESC 202, p. 59].
PSC 114.210	Referenced sections [NESC 210, p. 60].
PSC 114.219	Marking of poles and structures carrying high voltage supply lines.
PSC 114.230A	Clearances [NESC 230A, p. 69].
PSC 114.234A4	Transmission lines over dwelling occupancies [follows NESC 234A3, p. 94].
PSC 114.234C1a	Vertical and horizontal clearances.
PSC 114.234C3d	Supply conductors attached to buildings or other installations [NESC 234C3d, p. 97].

PSC 114.234C6	Clearance of lines near stored materials [Follows NESC 234C5, p. 102].
PSC 114.234C7	Clearance of lines near fuel storage tanks [Follows NESC 234C5, p. 102].
PSC 114.234C8	Clearance of lines near wells [Follows NESC 234C5, p. 102].
PSC 114.234C9	Clearance of lines near antennas [Follows NESC 234C5, p. 102].
PSC 114.234E1	Clearance of wires, conductors, or cables installed over or near swimming areas with no wind displacement [NESC 234E1, p. 104].
PSC 114.234F1	Grain bins loaded by permanently installed augers, conveyers, or elevator systems [Following NESC 234F1, P. 109].
PSC 114.235C2b	(1)(a) Sag-related clearances [Follows NESC 235C2b(1)(a), p. 120].
PSC 114.242G	Grades of construction for conductors [Follows NESC 242F, p. 143].
PSC 114.250D	Longitudinal capability [Follows NESC 250C, p. 148].
PSC 114.302	Application of rules [NESC 302, p. 173].
PSC 114.310	Referenced sections [NESC 310, p. 174].
PSC 114.311C	Installation and maintenance [Follows NESC 311B, p. 174].
PSC 114.317	Outdoor location of oil-insulated padmounted transformers near buildings [Follows NESC 316, p. 175].
PSC 114.320B7	Separation from other underground installations.
PSC 114.352E	Separations from other underground structures [Follows NESC 352D, p. 188].
PSC 114.354D1g	Random separation – additional requirements [NESC 354D1g, p. 190].
PSC 114.381H	Warning signs [Follows NESC 381G, p. 194].
PSC 114.402	Referenced sections [NESC 402, p. 197].
PSC 114.444A3	De-energizing equipment or lines to protect employees—application of rule [NESC 444A3, p. 219].

Note: Chapter PSC 114 as it existed on April 30, 1991 was repealed and a new chapter PSC 114 was created effective May 1, 1991; Chapter PSC 114 as it existed on December 31, 1993, was repealed and a new chapter PSC 114 was created effective January 1, 1994. **Chapter PSC 114 as it existed on September 30, 1997 was repealed and a new chapter PSC 114 was created effective October 1, 1997. Corrections made under s. 13.93 (2m) (b) 1., 6. and 7., Stats., Register, September, 1997, No. 501.**

Subchapter I — Administration and Enforcement

PSC 114.001 General information. (1) ADMINISTRATIVE AUTHORITIES. The Wisconsin State Electrical Code is issued and administered by the public service commission and the department of commerce, division of safety and buildings as part of the Wisconsin Administrative Code. The public service commission has primary responsibility for issuance and administration of Volume 1 as found in this chapter. The department of commerce, division of safety and buildings has similar responsibility for issuance and administration of Volume 2 which is found in ch. Comm 16.

(2) AVAILABILITY OF STATE ELECTRICAL CODE. The public service commission has adopted the 1997 edition of the National Electrical Safety Code (NESC—1997) with certain deletions, changes and additions which are found in Volume 1, Wisconsin State Electrical Code. Copies of the NESC may be purchased from the Institute of Electrical and Electronics Engineers, Inc., IEEE Service Center, 445 Hoes Lane, P.O. Box 1331, Piscataway, NJ 08855-1331 (telephone 1-800-678-IEEE) or the American National Standards Institute, 1430 Broadway, New York, NY 10018 (telephone 212/ 642-4900). Copies of Volume 1, Wisconsin State Electrical Code, may be ordered from the Wisconsin Department of Administration, Document Sales, 202 S. Thornton Avenue, Madison, WI 53702, (telephone 608/ 266-3358).

Note: The department of commerce, division of safety and buildings, has similarly adopted the National Electrical Code (NEC) with certain deletions, changes and additions which are found in Volume 2, Wisconsin State Electrical Code. Copies of Volume 2, Wisconsin State Electrical Code, may be ordered from the Wisconsin Department of Administration, Document Sales, 202 S. Thornton Avenue, Madison, WI

53702. See ch. Comm 16, Wis. Adm. Code, for current availability information for the NEC.

History: Cr. Register, September, 1997, No. 501, eff. 10-1-97.

PSC 114.002 Purpose and scope. (1) PURPOSE. The purpose of this chapter is the practical safeguarding of persons during the installation, operation or maintenance of electric supply and communication lines and their associated equipment. This chapter contains minimum provisions considered necessary for the safety of employees and the public. This chapter is not intended as a design specification or an instruction manual.

(2) SCOPE. (a) This chapter applies to supply and communication lines, equipment, and associated work practices employed by an electric supply, communication, railway, or similar utility in the exercise of its function as a utility. In addition, this chapter prohibits the location of buildings, structures, and equipment; materials storage and change of grade, by any person in violation of the clearance requirements of this chapter. This chapter has also been adopted by the department of commerce as part of Volume 2, Wisconsin State Electrical Code, for application to installations over 600 volts of parties other than utilities.

(b) This chapter does not apply to installations in mines, ships, railway rolling equipment, aircraft or automotive equipment, or utilization wiring except as covered in Parts 1 and 3, NESC—1997.

History: Cr. Register, September, 1997, No. 501, eff. 10-1-97.

PSC 114.003 Authority and statutory references. (1) STATUTORY AUTHORITY. Volume 1, Wisconsin State Electrical Code, constitutes a general order of the public service commission authorized by ss. 196.74 and 227.11, Stats.

(2) STATUTORY ENFORCEMENT. (a) Compliance with the requirements of Volume 1, Wisconsin State Electrical Code, is required before a utility may provide electric service even though some portions of the code may not be directly enforceable by state agencies. See s. 101.865, Stats. The authority for the enforcement of Volume 1, Wisconsin State Electrical Code, is vested in the pub-

lic service commission with respect to the installation and operation of circuits or equipment by public utilities and railroads in the exercise of their functions as utilities and railroads.

Note: While the public service commission does not have jurisdiction for enforcement of Volume 1, Wisconsin State Electrical Code, over parties other than public utilities and railroads, electric utilities are prohibited under s. 101.865, Stats., from extending electric service to premises which are not in compliance with the Wisconsin State Electrical Code, which includes both Volumes 1 and 2.

(b) The requirements in the code are enforceable in the same manner as other orders of the public service commission.

Note: See ss. 102.57, 102.58, 195.07, 196.41, 196.64, 196.66, 196.74, and ch. 227, Stats.

(3) OTHER REQUIREMENTS. (a) Nothing in this chapter shall be construed to deprive a municipality of jurisdiction over utilities, places of employment or public buildings, except that no local requirements shall be less stringent than the requirements in this chapter. See s. 196.58, Stats.

(b) A utility may file with the public service commission requirements covering subject matter which is a part of this code, but such requirements must be acceptable and not less stringent than the requirements of this chapter. See s. 196.19, Stats.

Note: There are state statutes that refer directly to certain electrical construction. Some of these are: ss. 66.0831, 86.16, 101.865, 134.40, 134.41, 182.017, 182.0175, 182.018, 196.171, 196.58, 196.67, and 196.72, Stats.

(4) COMPLAINTS. If a complaint is filed with the public service commission by any interested party to the effect that public safety requires changes in construction or methods of operation, the public service commission shall investigate and make recommendations. See s. 196.74, Stats., for procedure if changes in utility facilities are necessary.

History: Cr. Register, September, 1997, No. 501, eff. 10-1-97.

Subchapter II — General Requirements

PSC 114.004 General requirements. (1) CHARACTER OF CONSTRUCTION, MAINTENANCE AND OPERATION. All electrical power and communication equipment and lines shall be of such construction, and so installed, operated and maintained as to minimize the life and fire hazard.

(2) CONSTRUCTION, INSPECTION AND REPAIRS. (a) All construction and equipment shall be cleaned when necessary and inspected at such intervals as experience has shown to be necessary. Any equipment or construction known to be defective so as to endanger life or property shall be promptly repaired, permanently disconnected, or isolated until repairs can be made. Construction, repairs, additions and changes to electrical equipment and conductors shall be made by qualified persons only.

(b) Facilities installed or used in the generation, transmission, distribution and utilization of electricity shall be designed for such installation or use.

History: Cr. Register, September, 1997, No. 501, eff. 10-1-97.

PSC 114.005 Application of rules. (1) NEW INSTALLATIONS AND EXTENSIONS. (a) This chapter shall apply in full to all new installations, reconstructions, alterations and extensions, except as modified or waived by the commission when any rule is shown to be impractical for special reasons or where the advantage of uniformity with existing construction is greater than the advantage of construction in compliance with the rules, providing the existing construction is reasonably safe;

(b) By bringing existing installations into conformity with these rules as far as may be directed by the commission and within the time determined by said agency; or

(c) Where the requirement is waived by the commission under sub. (3).

(2) EXISTING INSTALLATIONS. (a) Where an existing installation meets, or is altered to meet these rules, such installation is considered to be in compliance with this edition and is not required to comply with any previous edition.

(b) Existing installations, including maintenance replacements, which comply with prior editions of the code, need not be modified to comply with these rules except as may be required for safety reasons by the administrative authority.

(c) Where conductors or equipment are added, altered, or replaced on an existing structure, the structure or the facilities on the structure need not be modified or replaced if the resulting installation will be in compliance with either the rules in effect:

1. At the time of the original installation.
2. At the time of an addition, alteration, or replacement.
3. Currently in accordance with par. (a).

(3) WAIVING RULES. This chapter is intended to apply to all installations, except as modified or waived by the commission. The rules are intended to be so modified or waived in particular cases whenever any rules are shown for any reason to be impractical or if equivalent safety is secured in other ways.

(4) TEMPORARY INSTALLATIONS. Modifying or waiving certain of the rules will sometimes be necessary in case of temporary installations or installations which are shortly to be dismantled or reconstructed. Such temporary construction may be used for a reasonable length of time without fully complying with this code, provided it is under competent supervision while it or adjoining equipment is energized, or if it is protected by suitable barriers or warning signs when accessible to any person; but all such construction shall be made reasonably safe.

(5) TESTING. Rooms which are used exclusively for routine or special electrical test work, and therefore are under the supervision of a qualified person, need comply with this code only insofar as is practical for the character of the testing done.

(6) EMERGENCY. In case of emergency the person responsible for the installation may decide to modify or waive any requirement of this chapter, subject to review by the commission, even should an application be pending before the commission for a requested emergency related modification or waiver.

(7) INTENT. Rules in this chapter which are to be regarded as mandatory are characterized by the use of the word shall. Where a rule is of an advisory nature, to be followed insofar as practical, it is indicated by the use of the word should. Other practices which are considered desirable are stated as RECOMMENDATIONS. NOTES, other than footnotes to tables, are for information purposes only and are not to be considered as mandatory or as part of the code requirements.

History: Cr. Register, September, 1997, No. 501, eff. 10-1-97.

PSC 114.006 Adoption of standard by reference.

(1) ADOPTION OF STANDARD. The National Electrical Safety Code-1997 edition (also American National Standards Institute C2-1997 edition) subject to omissions, changes and additions as otherwise shown in this chapter, is hereby incorporated by reference into the Wisconsin State Electrical Code, Volume 1. Interim amendments to the NESC-1997 will not be effective in this state until such time as this chapter is revised to reflect such changes.

(2) CONSENT TO INCORPORATE NESC-1997 BY REFERENCE. Pursuant to s. 227.21, Stats., the attorney general and the revisor of statutes have consented to the incorporation by reference of these standards contained in the NESC-1997, except for the omissions, changes and additions as shown later in this chapter. Copies of the NESC-1997 are on file in the offices of the public service commission, the secretary of state, and the revisor of statutes.

History: Cr. Register, September, 1997, No. 501, eff. 10-1-97.

Subchapter III — Omissions, Changes or Additions to NESC-1997

PSC 114.007 Omissions, changes, additions to NESC-1997. Omissions, changes or additions to the NESC-1997 are specified in this subchapter and are rules of the

public service commission and not requirements of the NESC-1997.

Note: Each omission, change or addition is found in the same location in this subchapter as the appropriate NESC part, section or subsection where the affected rule is found. Each change or addition has been prefixed by PSC 114. Following the PSC designation is the referenced NESC section or subsection and the page on which it is found in the NESC. Example: PSC 114.096 [NESC 96C, p. 23]. The word "Change" following the section number and heading means that the corresponding wording of the NESC-1997 has been changed and that the new wording is substituted at the appropriate location. The word "Addition" following the section number and heading means that a new requirement is incorporated in the NESC-1997 and that the new requirement is inserted at the appropriate location.

Note: To observe federal directives and recommendations that national standards adopt the metric system for units of measure, the numerical values of the NESC-1997 are stated in the metric system and in the customary inch-foot-pound system. To conform to this more international convention, this revision of the Wisconsin State Electrical Code, Volume 1 also adopts the same measurement convention. In the text, the metric value is now shown first with the customary inch-foot-pound value (in parentheses) following. In tables, the metric values are also given first and where the entire tables are duplicated, the table of metric values appears first with the table of inch-foot-pound values following.

History: Cr. Register, September, 1997, No. 501, eff. 10-1-97.

Section 1. Introduction to the National Electrical Safety Code

PSC 114.010 Omissions [NESC 010 through 016, pp. 1-2]. Introduction to the National Electrical Safety Code (Section 1) (Omission) Rules 010 through 016 of the NESC-1997 are omitted and not incorporated as part of the Wisconsin State Electrical Code, Volume 1.

History: Cr. Register, September, 1997, No. 501, eff. 10-1-97.

Section 2. Definitions of Special Terms

PSC 114.02 Definitions [NESC Section 2, p. 4]. (1) Change the definition of "Administrative Authority" to read:

(a) *Administrative authority.* The authority for the enforcement of this code is vested in the public service commission with respect to the installation and operation of circuits or equipment by public utilities and railroads in the exercise of their functions as utilities and railroads.

(2) Add the following definition:

(a) *Commission.* Public service commission of Wisconsin.

History: Cr. Register, September, 1997, No. 501, eff. 10-1-97.

Section 3. References

PSC 114.03 References [NESC, p. 14]. (1) Change reference NFPA 70-1993, National Electrical Code (NEC). [Rules 011, 124 and 127] to read as follows:

(a) ANSI/NFPA 70-1996, National Electrical Code (NEC). [Rules 011, 124, and 127]

(2) Change reference NFPA 30-1990, Flammable and Combustible Liquids Code. [Rule 127] to read as follows:

(a) NFPA 30-1996, Flammable and Combustible Liquids Code. [Rule 127]

History: Cr. Register, September, 1997, No. 501, eff. 10-1-97.

Section 9. Grounding Methods for Electric Supply and Communications Facilities

PSC 114.094 Grounding methods for electric supply and communication facilities [NESC 94B4, pp. 21-22] (Section 9). (1) Rule 94B4 of the NESC-1997 is omitted and not incorporated as part of the Wisconsin State Electrical Code, Volume 1.

History: Cr. Register, September, 1997, No. 501, eff. 10-1-97.

PSC 114.096 Multi-grounded systems [NESC 96C, p. 23]. (1) Change paragraph C to read:

C. The neutral, which shall be of sufficient size and ampacity for the duty involved, shall be connected to a made or existing electrode at each transformer location and at a sufficient number of

additional points with made or existing electrodes to total not less than nine grounds in each 1.6 km (1 mi) of line, including those grounds at transformer locations, but not including grounds at individual services. In rural districts, the primary neutral shall be connected to a made or existing electrode at each pole to which it is attached. For the purposes of this rule, rural districts are those areas outside of cities and villages.

Exception 1: In underground multi-grounded systems where an insulating jacket or nonmetallic conduit is used over direct-buried concentric-neutral supply cable, this requirement may be reduced to four grounds in each 1.6 km (mile). This exception for use of supply cable with an insulating jacket or nonmetallic conduit shall not be permitted for random lay construction. See Part 3, Rule 354, "Random Separation—Additional Requirements."

Exception 2: Where underwater crossings are encountered, the requirements of made electrodes do not apply for the underwater portion if the neutral is of sufficient size and capacity for the duty involved and the requirements of Rule 92B2 are met.

Note: Multi-grounded systems extending over a substantial distance are more dependent on the multiplicity of grounding electrodes than on the resistance to ground of any individual electrode. Therefore, no specific values are imposed for the resistance of individual electrodes.

History: Cr. Register, September, 1997, No. 501, eff. 10-1-97.

PSC 114.097 Separation of grounding conductors [NESC 97C, p. 24]. (1) Change paragraph C to read:

C. Primary and secondary circuits utilizing a single conductor as a common neutral shall have at least nine ground connections on such conductor in each 1.6 km (1 mi) of line, including those grounds at transformer locations, but not including ground connections at customers' service equipment.

History: Cr. Register, September, 1997, No. 501, eff. 10-1-97.

PSC 114.097D2 Multi-grounded systems [NESC 97D2, p. 24]. (1) Change paragraph 2 to read:

2. Multi-grounded Systems

On multi-grounded systems, the primary and secondary neutrals shall be interconnected according to Rule 97B. However, where it is necessary to separate the neutrals, interconnection of the neutrals shall be made through a spark gap or an electronic switching device designed for the purpose. The gap or device shall have a 60 Hz breakdown voltage not exceeding 3 kV and have a short circuit current withstand capability greater than the short circuit current available at the location of installation. At least one other grounding connection on the secondary neutral shall be provided in addition to the customer's grounds at each service entrance. A distance of not less than 3.60 m (12 ft) shall separate the secondary neutral grounding electrode from the primary neutral and surge arrester ground electrode and any buried portion of bare grounding electrode conductors connected to either electrode. Since a difference of potential will exist where primary and secondary neutrals are not directly interconnected, the primary or secondary grounding conductor shall be insulated for 600 V.

Note: Cooperation of all communications and supply utilities, customers of these utilities, and others may be necessary to obtain effective isolation between primary and secondary neutrals.

History: Cr. Register, September, 1997, No. 501, eff. 10-1-97.

Part 1. Rules for the Installation and Maintenance of Electrical Supply Stations and Equipment

Section 12. Installation and Maintenance of Equipment

PSC 114.127 Classified locations [NESC 127, pp. 45 and 46]. (1) Change the second parenthetical reference line 2 of Rule 127 on page 45 from "(NFPA 70-1993)" to "(NFPA 70-1996)".

(2) Change the references in Rules 127C (line 2), 127D (line 3), 127E (line 2) and 127F (line 2) on page 46 from "NFPA 30-1990" to "NFPA 30-1996".

History: Cr. Register, September, 1997, No. 501, eff. 10-1-97.

Part 2. Safety Rules for the Installation and Maintenance of Overhead Electric Supply and Communication Lines

Section 20. Purpose, Scope and Application of Rules

PSC 114.202 Application of rules [NESC 202, p. 59].

(1) Change the paragraph 202 to read:

202. Application of rules

The general requirements for application of these rules are contained in Rule PSC 114.05. However, when a structure is replaced, arrangement of equipment shall conform to the current edition of Rule 238C.

History: Cr. Register, September, 1997, No. 501, eff. 10-1-97.

Section 21. General Requirements

PSC 114.210 Referenced sections [NESC 210, p. 60].

(1) Change paragraph 210 to read:

210. Referenced Sections

The Introduction (Section 1) as amended by ss. PSC 114.001 to 114.007, Definitions (Section 2) as amended by Section 2 of Chapter PSC 114, List of Referenced Documents (Section 3) as amended by Section 3 of Chapter PSC 114 and Grounding Methods (Section 9) as amended by Section 9 of Chapter PSC 114 shall apply to the requirements of Part 2.

History: Cr. Register, September, 1997, No. 501, eff. 10-1-97; correction made under s. 13.93 (2m) (b) 7., Stats.

PSC 114.219 Marking of Poles and Structures Carrying High Voltage Supply Lines. [Follows NESC 218, p. 63] Add the following section:

PSC 114.219 Marking of poles and structures carrying high voltage supply lines.

(1) Every corporation, company or person constructing, operating or maintaining an electric transmission line with a voltage of 2,000 or more between conductors and the ground shall place warning signs from 1.2 to 2.45 m (4 to 8 ft) above the ground upon all poles or other structures supporting the line.

Exception: Existing poles and structures which were required to be signed by s. 196.67, stats. and were installed prior to January 1, 1995, are permitted to comply with the warning sign requirements which existed on December 31, 1994.

(2) Warning signs installed as replacements or new facilities on overhead electrical supply line poles and structures shall comply with the following standards:

(a) Warning signs which meet the requirements as to format and color of American National Standards Institute standard ANSI Z535-1991 for safety signs.

(b) The overall dimensions of these signs shall not be less than 25.4 cm by 17.78 cm (10 in by 7 in) except that in those situations where use of a sign this size is not practical, two or more signs not smaller than 17.78 cm by 12.7 cm (7 in by 5 in) may be substituted.

Exception: Existing poles and structures installed prior to the effective date of this chapter adopting the new warning sign standard are permitted to continue to use the "Danger - High Voltage" sign format meeting the requirements of the prior rule until such signs are replaced.

Note: This rule amends and expands the application of the warning sign requirements of s. 196.67, stats., as it existed prior to its revision which became effective on January 1, 1995. In 1993, this statute was revised by deleting the specified location provisions limiting the required signing to certain poles. As a result, all poles and structures supporting lines with a voltage of 2,000 or more installed after the effective date of January 1, 1995, are required to carry warning signs. See s. 196.67, stats.

History: Cr. Register, September, 1997, No. 501, eff. 10-1-97.

Section 23. Clearances

Note: The specification of clearances in Rules 232, 233, and 234, first adopted in the NESC-1990, and continued in the 1997 edition of the NESC adopted herein, have been revised in both concept and content to reflect the new Uniform System of Clear-

ances approach which is described in Appendix A of NESC-1990, NESC-1993 and NESC-1997. Because the approach and the application of the rules have been revised, it must be understood that clearance values of editions of the national and state codes prior to 1990 cannot be directly compared to those of editions of the codes after 1990. See Appendix A of NESC-1990, NESC-1993 or NESC-1997.

PSC 114.230A Clearances [NESC 230A, p. 69]. (Section 23) Rule 230A of the NESC-1997 is omitted and not incorporated as part of the Wisconsin State Electrical Code, Volume 1.

Table PSC 114.232-1 [NESC, Table 232-1, pp. 74-76: Metric; pp. 77-79: Feet] Vertical Clearance of Wires, Conductors and Cables Above Ground, Rails, or Water Surfaces (Changes and Additions)

The Footnotes for NESC Table 232-1 on page 76 (Metric) and page 79 (Feet) contain the following changes and additions:

Change Footnote 17 to read as follows:

17 For controlled impoundments, the surface area and corresponding clearances shall be based upon the design high water level. For other waters, the surface area and clearances shall be based on the normal high water level. The clearance over rivers, streams, and canals shall be based upon the largest surface area of any 1.6-km-long (1 mi) segment which includes the crossing. The clearance over a river, stream, or canal normally used to provide access for sailboats to a larger body of water shall be the same as that required for the larger body of water.

Change Footnote 19 to read as follows:

19 Where the US Army Corps of Engineers, or the state, or surrogate thereof has issued a crossing permit, the greater clearances of that permit shall govern.

Add Footnote 26 which reads as follows:

26 A diagonal clearance equal to the required vertical clearance shall be maintained to uneven or sloping terrain within a horizontal distance of 3/4 (75%) of the required vertical clearance. All distances shall be measured from the conductors in their wind-displaced position as defined in NESC Rule 234A2.

Add the reference to Footnote 26 in NESC-1997 Table 232-1 on pp. 74-75 (Metric) and pp. 77-78 (Feet) to the conductor category titles of columns 3, 4 and 5. It applies to all clearances in those columns.

Table PSC 114-232-3 [NESC, Table 232-3, p. 82] Reference Heights (Change) Change Footnote 3 to read:

3 For controlled impoundments, the surface area and corresponding clearances shall be based upon the design high water level. For other waters, the surface area and clearances shall be based on the normal high water level. The clearance over rivers, streams, and canals shall be based upon the largest surface area of any 1.6-km-long (1 mi) segment which includes the crossing. The clearance over a canal, river or stream normally providing access for sailboats to a larger body of water shall be the same as that required for the larger body of water.

History: Cr. Register, September, 1997, No. 501, eff. 10-1-97.

PSC 114.234A4 Transmission lines over dwelling occupancies [follows NESC 234A3, p. 94]. (1) Add the following paragraph 4:

4. Transmission Lines Over Dwelling Occupancies

Supply lines designed to operate at voltages in excess of 35 kV shall not be constructed over dwellings or mobile homes intended for residential occupancy and dwellings or mobile homes intended for residential occupancy shall not be located under such lines. This provision is also intended to cover the line conductors in their wind-displaced position as defined in Rule 234A2.

Note: The term "dwelling", as used herein, is the same as defined in Volume 2, Wisconsin State Electrical Code (NEC/NFPA 70-1996), i.e., "Dwelling Unit: One or more rooms for the use of one or more persons as a housekeeping unit with space for eating, living, and sleeping, and permanent provisions for cooking and sanitation."

Note: Electric utilities are prohibited by s. 101.865, Stats., from extending electric service to premises which are not in compliance with the Wisconsin State Electrical Code.

History: Cr. Register, September, 1997, No. 501, eff. 10-1-97.

PSC 114.234C1a Vertical and horizontal clearances. (1) (a) [NESC 234C1a, p. 97] Change paragraph (1) (a) to read:

(a) *Clearances.* Unguarded or accessible wires, conductors, cables, or rigid live parts may be located adjacent to buildings, signs, billboards, chimneys, radio and television antenna, tanks, and other installations and any projections therefrom. The vertical and horizontal clearances of such rigid and nonrigid parts shall be not less than the values in Table 234-1 when at rest under the conditions specified in Rule 234A1. These facilities may be installed beside, over or under buildings, building projections and other installation, as illustrated in Figs. 234-1(a) and 234-1(b). Buildings, signs, billboards, chimneys, radio and television antennas, tanks, and other installations and any projections therefrom shall not be located near existing wires, conductors, cables or rigid live parts if doing so results in clearances less than the values given in Table 234-1.

History: Cr. Register, September, 1997, No. 501, eff. 10-1-97.

PSC 114.234C3d Supply conductors attached to buildings or other installations [NESC 234C3d, p. 97]. Change Exception 1 to read:

Exception 1: Where the voltage between conductors does not exceed 300 volts and the roof has a slope of not less than 1 (vertical) to 3 (horizontal), this clearance may be reduced to 0.90 m (3 ft).

Table PSC 114.234-1 [NESC Table 234-1, pp. 99-100 (Metric) and pp. 101-102 (Feet)] Clearance of Wires, Conductors, Cables, and Unguarded Rigid Live Parts Adjacent But Not Attached to Buildings and Other Installations Except Bridges (Changes, Deletions and Additions).

Table PSC 114.234-1 Metric, which follows, contains the following changes, deletions and additions to NESC Table 234-1 Metric:

The reference to Footnote 5 is added to the category title of Column 2.

The reference to Footnote 5 is deleted from the category title of Column 3.

The value in Item (Row) 1.b.(1), Column 2 is revised from "0.90" to "2.45".

The value in Item (Row) 1.b.(1), Column 3 is revised from "1.07" to "2.45".

Footnote 15 is added.

The reference to Footnote 15 is added to the values in Item (Row) 1.b.(1), Columns 2 and 3.

Table PSC 114.234-1 Feet, which follows, contains the following changes, deletions and additions to NESC Table 234-1 Feet:

The reference to Footnote 5 is added to the category title of Column 2.

The reference to Footnote 5 is deleted from the category title of Column 3.

The references to Footnotes 1 and 2 for the value in Item (Row) 1.a.(2), Column 5 are deleted.

The value in Item (Row) 1.b.(1), Column 2 is revised from "3.0" to "8.0."

The value in Item (Row) 1.b.(1), Column 3 is revised from "3.5" to "8.0."

The reference to Footnotes 1 and 2 are added to the values in Item (Row) 2.a., Column 4 and Column 6.

Footnote 15 is added.

The reference to Footnote 15 is added to the values in Item (Row) 1.b.(1), Columns 2 and 3.

Table PSC 114.234-1 **m**
Clearance of Wires, Conductors, Cables, and Unguarded Rigid Live Parts Adjacent but Not Attached to Buildings and Other Installations Except Bridges¹²

(Voltages are phase to ground for effectively grounded circuits and those other circuits where all ground faults are cleared by promptly de-energizing the faulted section, both initially and following subsequent breaker operations. See the definitions section for voltages of other systems. Clearances are with no wind displacement except where stated in the footnotes below. See Rules 234C1a, 234C2, and 234H4.)

Clearance of	Insulated communication conductors and cables; messengers; surge-protection wires; grounded guys; ungrounded guys exposed to 0 to 300 V ¹³ neutral conductors meeting Rule 230E1; supply cables meeting Rule 230C1 ⁵ (m)	Supply cables of 0 to 750V meeting Rules 230C2 or 230C3 (m)	Unguarded rigid live parts, 0 to 750V; non-insulated communication conductors, ungrounded equipment cases, ungrounded guys exposed to open supply conductors of over 300V to 0 to 750V; ² and 750V ⁵ (m)	Supply cables over 750V meeting Rules 230C2 or 230C3; open supply conductors, 0 to 750V (m)	Unguarded rigid live parts, over 750V to 22kV, ungrounded equipment cases, 750V to 22kV, ungrounded guys exposed to over 750V to 22kV ⁵ (m)	Open supply conductors, over 750V to 22kV (m)
1. Buildings						
a. Horizontal						
(1) To walls, projections and guarded windows	1.40 ^{1,2,7}	1.50 ^{1,2}	1.50 ^{1,2}	1.70 ^{1,2,9}	2.00 ^{1,2}	2.30 ^{1,2,10,11}
(2) To unguarded windows ⁸	1.40	1.50	1.50	1.70 ⁹	2.00	2.30 ^{10,11}
(3) To balconies and areas readily accessible to pedestrians ³	1.40	1.50	1.50	1.70 ⁹	2.00	2.30 ^{10,11}
b. Vertical ¹⁴						
(1) Over or under roofs or projections not readily accessible to pedestrians ³	2.45 ¹⁵	2.45 ¹⁵	3.0	3.2	3.6	3.8
(2) Over or under balconies and roofs readily accessible to pedestrians ³	3.2	3.4	3.4	3.5	4.0	4.1
(3) Over roofs accessible to vehicles but not subject to truck traffic ⁶	3.2	3.4	3.4	3.5	4.0	4.1
(4) Over roofs accessible to truck traffic ⁶	4.7	4.9	4.9	5.0	5.5	5.6
2. Signs, chimneys, billboards, radio and television antennas, tanks, and other installations not classified as buildings or bridges						
a. Horizontal ⁴	0.90	1.07	1.50 ^{1,2}	1.70 ^{1,2,9}	2.00 ^{1,2}	2.30 ^{1,2,10,11}
b. Vertical						
(1) Over or under catwalks and other surfaces upon which personnel walk	3.2	3.4	3.4	3.5	4.0	4.1
(2) Over or under other portions of such installations ⁴	0.90	1.07	1.70	1.80 ¹	2.45	2.30

Footnotes to Table 234.1

(m)

1Where building, sign, chimney, antenna, tank, or other installation does not require maintenance such as painting, washing, changing of sign letters, or other operations that would require persons to work or pass between wires, conductors, cables, or unguarded rigid live parts and structure, the clearance may be reduced by 0.60 m.

2Where available space will not permit this value, the clearance may be reduced by 0.60 m provided the wires, conductors, or cables, including splices and taps, and unguarded rigid live parts have a covering that provides sufficient dielectric strength to limit the likelihood of a short circuit in case of momentary contact with a structure or building.

3A roof, balcony, or area is considered readily accessible to pedestrians if it can be casually accessed through a doorway, ramp, window, stairway, or permanently mounted ladder by a person on foot who neither exerts extraordinary physical effort nor employs special tools or devices to gain entry. A permanently mounted ladder is not considered a means of access if its bottom rung is 2.45 m or more from the ground or other permanently installed accessible surface.

4The required clearances shall be to the closest approach of motorized signs or moving portions of installations covered by Rule 234C.

5Ungrounded guys and ungrounded portions of guys between guy insulators shall have clearances based on the highest voltage to which they may be exposed to a slack conductor or guy.

6For the purpose of this rule, trucks are defined as any vehicle exceeding 2.45 m in height.

7This clearance may be reduced to 75 mm for the grounded portions of guys.

8Windows not designed to open may have the clearance permitted for walls and projections.

9The clearance at rest shall be not less than the value shown in this table. Also, when the conductor or cable is displaced by wind, the clearance shall be not less than 1.07 m; see Rule 234C1b.

10The clearance at rest shall be not less than the value shown in this table. Also, when the conductor or cable is displaced by wind, the clearance shall be not less than 1.40 m; see Rule 234C1b.

11Where available space will not permit this value, the clearance may be reduced to 2.00 m for conductors limited to 8.7 kV to ground.

12The clearance values shown in this table are computed by adding the applicable Mechanical and Electrical (M&E) value of Table A-1 to the applicable Reference Component of Table A-2b of Appendix A.

13The anchor end of guys insulated in accordance with Rule 279 may have the same clearance as grounded guys.

14For clearances above railings, walls, or parapets around balconies or roofs, use the clearances required for roofs not accessible to pedestrians.

15This clearance may be reduced to 0.90 m for supply conductors limited to 300 V to ground and communications conductors and cables if the roof has a slope or not less than 1 (vertical) to 3 (horizontal).

Table PSC 114.234-1

ft

**Clearance of Wires, Conductors, Cables, and Unguarded Rigid Live Parts
Adjacent but Not Attached to Buildings and Other Installations Except Bridges¹²**

(Voltages are phase to ground for effectively grounded circuits and those other circuits where all ground faults are cleared by promptly de-energizing the faulted section, both initially and following subsequent breaker operations. See the definitions section for voltages of other systems. Clearances are with no wind displacement except where stated in the footnotes below. See Rules 234C1a, 234C2, and 234H4.)

Clearance of	Insulated communication conductors and cables; messengers; surge-protection wires; grounded guys; ungrounded guys exposed to 0 to 300 V ¹³ neutral conductors meeting Rule 230E1; supply cables meeting Rule 230C1 ⁵ (ft)	Supply cables of 0 to 750V meeting Rules 230C2 or 230C3 (ft)	Unguarded rigid live parts, 0 to 750V; non-insulated communication conductors, ungrounded equipment cases, 0 to 750V; and ungrounded guys exposed to open supply conductors of over 300V to 750V ⁵ (ft)	Supply cables over 750V meeting Rules 230C2 or 230C3; open supply conductors, 0 to 750V (ft)	Unguarded rigid live parts, over 750V to 22kV, ungrounded equipment cases, 750V to 22kV, ungrounded guys exposed to over 750V to 22kV ⁵ (ft)	Open supply conductors, over 750V to 22kV (ft)
1. Buildings						
a. Horizontal						
(1) To walls, projections and guarded windows	4.5 ^{1,2,7}	5.0 ^{1,2}	5.0 ^{1,2}	5.5 ^{1,2,9}	7.0 ^{1,2}	7.5 ^{1,2,10,11}
(2) To unguarded windows ⁸	4.5	5.0	5.0	5.5 ⁹	7.0	7.5 ^{10,11}
(3) To balconies and areas readily accessible to pedestrians ³	4.5	5.0	5.0	5.5 ⁹	7.0	7.5 ^{10,11}
b. Vertical ¹⁴						
(1) Over or under roofs or projections not readily accessible to pedestrians ³	8.0 ¹⁵	8.0 ¹⁵	10.0	10.5	12.0	12.5
(2) Over or under balconies and roofs readily accessible to pedestrians ³	10.5	11.0	11.0	11.5	13.0	13.5
(3) Over roofs accessible to vehicles but not subject to truck traffic ⁶	10.5	11.0	11.0	11.5	13.0	13.5
(4) Over roofs accessible to truck traffic ⁶	15.5	16.0	16.0	16.5	18.0	18.5
2. Signs, chimneys, billboards, radio and television antennas, tanks, and other installations not classified as buildings or bridges						
a. Horizontal ⁴	3.0	3.5	5.0 ^{1,2}	5.5 ^{1,2,9}	7.0 ^{1,2}	7.5 ^{1,2,10,11}
b. Vertical						
(1) Over or under catwalks and other surfaces upon which personnel walk	10.5	11.0	11.0	11.5	13.0	13.5
(2) Over or under other portions of such installations ⁴	3.0	3.5	5.5	6.0 ¹	7.5	8.0

Footnotes to Table 234.1

(ft)

1Where building, sign, chimney, antenna, tank, or other installation does not require maintenance such as painting, washing, changing of sign letters, or other operations that would require persons to work or pass between wires, conductors, cables, or unguarded rigid live parts and structure, the clearance may be reduced by 2 ft.

2Where available space will not permit this value, the clearance may be reduced by 2 ft provided the wires, conductors, or cables, including splices and taps, and unguarded rigid live parts have a covering that provides sufficient dielectric strength to limit the likelihood of a short circuit in case of momentary contact with a structure or building.

3A roof, balcony, or area is considered readily accessible to pedestrians if it can be casually accessed through a doorway, ramp, window, stairway, or permanently mounted ladder by a person on foot who neither exerts extraordinary physical effort nor employs special tools or devices to gain entry. A permanently mounted ladder is not considered a means of access if its bottom rung is 8 ft or more from the ground or other permanently installed accessible surface.

4The required clearances shall be to the closest approach of motorized signs or moving portions of installations covered by Rule 234C.

5Ungrounded guys and ungrounded portions of guys between guy insulators shall have clearances based on the highest voltage to which they may be exposed to a slack conductor or guy.

6For the purpose of this rule, trucks are defined as any vehicle exceeding 8 ft in height.

7This clearance may be reduced to 3 inches for the grounded portions of guys.

8Windows not designed to open may have the clearance permitted for walls and projections.

9The clearance at rest shall be not less than the value shown in this table. Also, when the conductor or cable is displaced by wind, the clearance shall be not less than 3.5 ft; see Rule 234C1b.

10The clearance at rest shall be not less than the value shown in this table. Also, when the conductor or cable is displaced by wind, the clearance shall be not less than 4.5 ft; see Rule 234C1b.

11Where available space will not permit this value, the clearance may be reduced to 7 ft for conductors limited to 8.7 kV to ground.

12The clearance values shown in this table are computed by adding the applicable Mechanical and Electrical (M&E) value of Table A-1 to the applicable Reference Component of Table A-2b of Appendix A.

13The anchor end of guys insulated in accordance with Rule 279 may have the same clearance as grounded guys.

14For clearances above railings, walls, or parapets around balconies or roofs, use the clearances required for roofs not accessible to pedestrians.

15This clearance may be reduced to 3 ft for supply conductors limited to 300 V to ground and communications conductors and cables if the roof has a slope or not less than 1 (vertical) to 3 (horizontal).

History: Cr. Register, September, 1997, No. 501, eff. 10-1-97.

PSC 114.234C6 Clearance of lines near stored materials [Follows NESC 234C5, p. 102]. Add the following paragraph 6 and note:

6. Clearance of Lines Near Stored Materials

Lines, under wind-displaced conditions stated in Rule 234A2, shall not be run over designated material storage areas where material is regularly stored and handled by cranes, dump trucks, elevators or other types of high machinery unless the clearance of such lines is adequate to permit full use of the equipment. Material which requires the use of such high machinery shall not be stored near or under existing lines.

Note: See NESC Rule 234F for Grain Bin clearances.

History: Cr. Register, September, 1997, No. 501, eff. 10-1-97.

PSC 114.234C7 Clearance of lines near fuel storage tanks [Follows NESC 234C5, p. 102]. Add the following paragraph 7 and exceptions 1 and 2:

7. Clearance of Supply Lines Near Fuel Storage Tanks

Supply lines shall not be run over above-ground flammable liquids and liquefied petroleum gas (LPG) storage tanks. A horizontal clearance of not less than 2.45 m (8 ft) with cables at rest, and not less than 1.80 m (6 ft) with cables displaced by wind according to Rule 234A2, shall be maintained between above-ground flammable liquids and liquefied petroleum gas storage tanks and supply cables of all voltages meeting Rule 230C. A horizontal clearance of not less than 4.6 m (15 ft) with conductors at rest, and not less than 3.0 m (10 ft) with conductors displaced by wind according to Rule 234A2, shall be maintained between such fuel storage tanks and all other supply conductors.

Exception 1: These requirements do not apply to liquefied petroleum gas tanks with a capacity of 1,000 gallons or less.

Exception 2: These requirements do not apply to tanks enclosed in a building or fully covered by a roof or canopy capable of preventing falling overhead supply conductors from directly contacting the tank. In this case, the vertical and horizontal clearance requirements of conductors from buildings apply. See Rule 234C.

History: Cr. Register, September, 1997, No. 501, eff. 10-1-97.

PSC 114.234C8 Clearance of lines near wells [Follows NESC 234C5, p. 102]. Add the following paragraph 8 and note:

8. Clearance of Open Supply Lines Near Wells

Open supply lines shall not be run over wells. A horizontal clearance with conductors at rest of no less than 3/4 of the vertical clearance of the conductors to ground required by Rule 232, and a horizontal clearance of not less than 3.0 m (10 ft) with conductors displaced by wind according to Rule 234A2, shall be maintained between open supply conductors and wells. Persons installing such wells shall also comply with this requirement.

Note: Electric utilities are prohibited by s. 101.865, Stats., from extending electric service to premises which are not in compliance with the Wisconsin State Electrical Code.

History: Cr. Register, September, 1997, No. 501, eff. 10-1-97.

PSC 114.234C9 Clearance of lines near antennas [Follows NESC 234C5, p. 102]. Add the following paragraph heading 9 and note:

9. Clearance of Lines Near Antennas

Note: Besides the applicable clearances of Rule 234C, additional requirements with respect to the proximity of antennas to power and communications lines are found in ss. Comm 62.39 and 62.40, Wis. Adm. Code.

History: Cr. Register, September, 1997, No. 501, eff. 10-1-97.

PSC 114.234E1 Clearance of wires, conductors, or cables installed over or near swimming areas with no wind displacement [NESC 234E1, p. 104]. Change paragraph E1 to read:

1. Swimming Pools

The following parts of pools shall not be placed under existing service-drop conductors or any other open overhead wiring; nor shall such wiring be installed above the following: (1) pools and the area extending 3.0 m (10 ft) horizontally from the inside of the walls of the pool; (2) diving structure; or (3) observation stands, towers, or platforms.

Exception 1: Structures listed in (1), (2), and (3) above shall be permitted under utility-owned supply lines or service drops where such installations provide the following clearances:

	Insulated supply or service cables, 0 to 750V to ground, supported on and cabled together with an effectively grounded bare messenger or effectively grounded neutral conductor	All other supply or service drop conductors	
		Voltage to ground	
		0 to 15kV	Greater than 15 to 22kV
A. Clearances in any direction to the water level, edge of water surface, base of diving platform or permanently-anchored raft	5.5m (18ft)	7.6m (25ft)	8.2m (27ft)
B. Clearance in any direction to the diving platform or tower	4.3m (14ft)	4.9m (16ft)	5.5m (18ft)
C. Horizontal limit of clearance measured from inside wall of pool	This limit shall extend to the outer edge of the structures listed in (1) and (2) above but not less than 3.0m (10ft).		

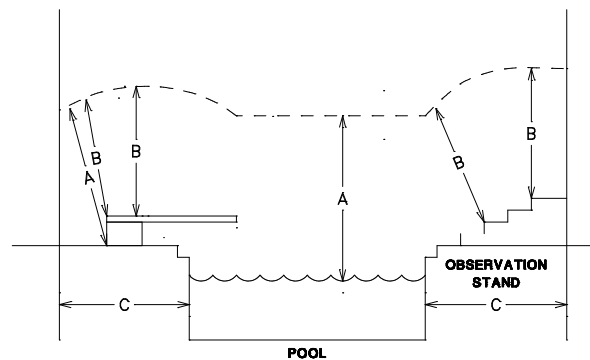

Figure PSC 114.234E1, Exception 1

Exception 2: Utility-owned, -operated, and -maintained communication conductors, community antenna system coaxial cables complying with Article 820 [NEC 1996-WSEC, Volume 2], and the supporting messengers shall be permitted at a height of not less than 3.0 m (10 ft) above swimming and wading pools, diving structures and observation stands, towers, or platforms.

Exception 3: This rule does not apply to a pool fully enclosed by a solid or screened permanent structure.

History: Cr. Register, September, 1997, No. 501, eff. 10-1-97.

PSC 114.234F1 Grain bins loaded by permanently installed augers, conveyers, or elevator systems [Following NESC 234F1, P. 109]. (1) (Addition) Add Exception to read:

Exception: Farm silos that are loaded by a blower through a vertical metal tube permanently attached to the side of the structure are not considered grain bins.

Note: Typical cylindrical farm silos are considered buildings for the purposes of this code and the clearance requirements of NESC Rule 234C, as amended herein, would apply.

History: Cr. Register, September, 1997, No. 501, eff. 10-1-97.

PSC 114.235C2b (1)(a) Sag-related clearances [Follows NESC 235C2b(1)(a), p. 120]. (Change and addition) (1) Change the present "Exception" to "Exception 1".

Add a new Exception 2 as follows:

Exception 2: For supply conductors of different utilities, vertical clearance at any point in the span need not exceed 75% of that required at the supports for the same utility from Table 235-5.

Table PSC 114.235-5 [NESC Table 235-5, p. 122 (Metric) and p. 123 (Inches)] Vertical Clearance Between Conductors at Supports. (Change)

In the metric table, change Footnote 6 to read as follows:

6 May be reduced to 0.75 m for supply neutrals meeting Rule 230E1, cables meeting Rule 230C1 where the supply neutral or messenger is bonded to the communication messenger, and for entirely dielectric "fiber-optic-supply" cable meeting Rule 230F1b.

In the inch table, change Footnote 6 to read as follows:

6 May be reduced to 30 in for supply neutrals meeting Rule 230E1, cables meeting Rule 230C1 where the supply neutral or messenger is bonded to the communication messenger, and for entirely dielectric "fiber-optic-supply" cable meeting Rule 230F1b.

History: Cr. Register, September, 1997, No. 501, eff. 10-1-97.

Section 24. Grades of Construction

PSC 114.242G Grades of construction for conductors [Follows NESC 242F, p. 143]. Add the following paragraph G:

G. Circuits Exceeding 175 kV to Ground

Grade B construction shall always be used if the voltage exceeds 175 kV to ground.

History: Cr. Register, September, 1997, No. 501, eff. 10-1-97.

Section 25. Loadings for Grades B and C

PSC 114.250D Longitudinal capability [Follows NESC 250C, p. 148]. Add the following paragraph D:

D. Longitudinal Capability

Each supply line designed to operate at 300 kV phase to phase or above shall be constructed to limit the effects of a cascading-type failure to a line segment not exceeding 9.6 km (6 mi) to 16 km (10 mi) in length. Such construction requirement may be met by providing, at appropriate intervals, structures and associated facilities having full dead-end capability under the loading provisions of Rules 250 A, B and C. Consideration shall be given to factors such as structure type and material, length of line, distance between dead-end or heavy angle structures, and other basic design criteria in determining the length of such individual line segments. For lines supported by "flexible" structures designed with plastic, energy-absorbing capability in failure, this require-

ment may be met if such design and construction will provide equivalent limitation to longitudinal cascading.

Table PSC 114.253-1 [NESC Table 253-1, p. 155] Overload Factors for Structures¹, Crossarms, Guys, Foundations, and Anchors to Be Used With the Strength Factors of

Table 261-1A. (Changes)

Change Footnote 2 to read:

2 For guys and anchors associated with structures supporting communications conductors and cables only, this factor may be reduced to 1.33. For guys associated with structures supporting supply conductors or supply conductors and communications conductors and cables, this factor may be reduced to 1.5.

Change Footnote 4 to read:

4 For guys associated with structures supporting only supply conductors or supply conductors and communications conductors and cables, this factor may be reduced to 2.00. This factor may be reduced to 1.75 for wood and reinforced (not prestressed) concrete structures when the span being supported is not at a crossing.

Table PSC 114.253-2 [NESC Table 253-2, p.156] Alternate Overload Factors for Wood and Reinforced (Not Prestressed) Concrete Structures to be Used With the Strength Factors of Table 261-1B. (Change)

Change Footnote 3 to read:

3 When structure strength deteriorates to the level of the loads multiplied by the overload factors required at replacement, the structure shall be replaced or rehabilitated. If a structure is replaced, it shall meet the "when installed" overload factors at replacement. Rehabilitated portions of structures shall have overload factors at the time of rehabilitation greater than of those required "at replacement". Where conductors or equipment are altered or replaced on existing structures, the structure need not be replaced provided the existing structure has the strength to withstand the loads specified in Section 25, multiplied by the "at replacement" overload factor in NESC Table 253-2 without exceeding the strength factors of NESC Table 261-1B.

Section 26. Strength Requirements

Table PSC 114.261-1A [NESC Table 261-1A, p. 163] Strength Factors for Structures, Crossarms, Guys, Foundations, and Anchors for Use With Overload Factors of Table 253-1 (Changes)

Change Footnote 2 to read:

2 Wood and reinforced concrete structures shall be replaced or rehabilitated when deterioration reduces the structure strength to 2/3 of that required when installed. If a structure is replaced, it shall meet the strength required by NESC Table 261-1A. Where conductors or equipment is altered or replaced, or where portions of a structure are rehabilitated, the remaining structures and rehabilitated portions thereof shall have strength greater than 2/3 of that required when installed.

Change Footnote 3 to read:

3 Wood and reinforced concrete structures shall be replaced or rehabilitated when deterioration reduced the structure strength to 3/4 of that required when installed. If a structure is replaced, it shall meet the strength required by NESC Table 261-1A. Where conductors or equipment are altered or replaced, or where portions of a structure are rehabilitated, the remaining structures and

rehabilitated portions thereof shall have strength greater than 3/4 of that required when installed.

History: Cr. Register, September, 1997, No. 501, eff. 10-1-97.

Part 3. Safety Rules for the Installation and Maintenance of Underground Electric Supply and Communication Lines

Section 30. Purpose, Scope, and Application of Rules

PSC 114.302 Application of rules [NESC 302, p. 173].

Change Rule 302 to read:

302. Application of Rules

The general requirements for application of these rules are contained in Rule PSC 114.05.

History: Cr. Register, September, 1997, No. 501, eff. 10-1-97.

Section 31. General Requirements Applying to Underground Lines

PSC 114.310 Referenced sections [NESC 310, p. 174].

Change Rule 310 to read:

310. Referenced sections

The Introduction (Section 1) as amended by ss. PSC 114.001 to 114.007, Definitions (Section 2) as amended by Section 2 of Chapter PSC 114, List of Referenced Documents (Section 3) as amended by Section 3 of Chapter PSC 114, and Grounding Methods (Section 9) as amended by Section 9 of Chapter PSC 114, shall apply to the requirements of Part 3.

History: Cr. Register, September, 1997, No. 501, eff. 10-1-97; correction made under s. 13.93 (2m) (b) 7., Stats.

PSC 114.311C Installation and maintenance [Follows NESC 311B, p. 174]. Add the following paragraph C:

C. Markers

When underground electric supply lines over 750 volts between conductors are located outside cities, villages, or developed areas, their location shall be marked in a manner recognizable to the public at each road crossing, railroad crossing, or drainage ditch crossing to identify the location of the facility.

History: Cr. Register, September, 1997, No. 501, eff. 10-1-97.

PSC 114.317 Outdoor location of oil-insulated pad-mounted transformers near buildings [Follows NESC 316, p. 175]. Add the following section:

PSC 114.317 Outdoor location of oil-insulated padmounted transformers near buildings.

A. Noncombustible and Combustible Walls

For the purposes of this section, combustible walls are walls of Type No. 8 buildings as determined by s. Comm 51.03, Wis. Adm. Code. All other walls are considered to be non-combustible.

B. Noncombustible Walls

Padmounted oil-insulated transformers may be located directly next to noncombustible walls if the following clearances are maintained from doors, windows and other building openings.

1. Padmounted oil-insulated transformers shall not be located within a zone extending 6.1 m (20 ft) outward and 3.0 m (10 ft) to either side of a building door. See Figure PSC 114-317B1.

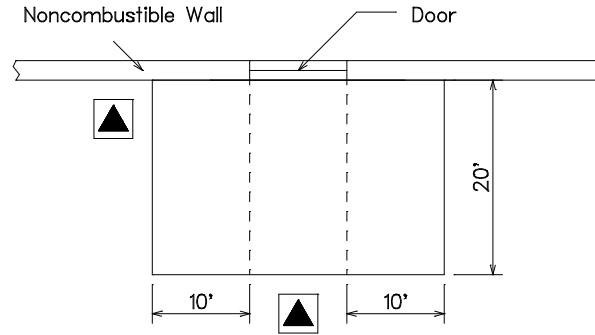

Figure PSC 114.317B1.

2. Padmounted oil-insulated transformers shall not be located within a zone extending 3.0 m (10 ft) outward and 3.0 m (10 ft) to either side of an air intake opening. Such transformers may be located within said zone beneath an air intake opening provided there is not less than 7.6 m (25 ft) diagonal separation between the transformer and said opening. See Figure PSC 114-317B2.

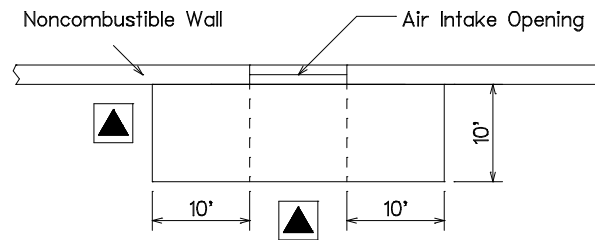

Figure PSC 114.317B2.

3.a. Padmounted oil-insulated transformers shall not be located within a zone extending 3.0 m (10 ft) outward and 0.9 m (3 ft) to either side of a building window or opening other than an air intake. See Figure PSC 114-317B3a.

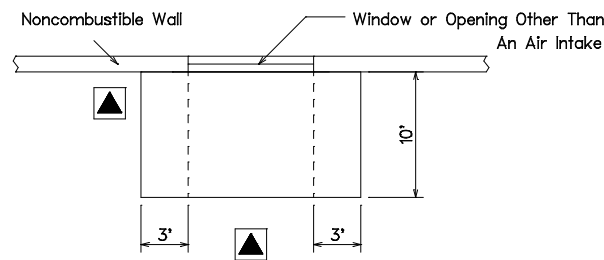

Figure PSC 114.317B3a.

3.b. For second story windows, the transformer shall not be located less than 1.5 m (5 ft) from any part of the window. See Figure PSC 317B3b.

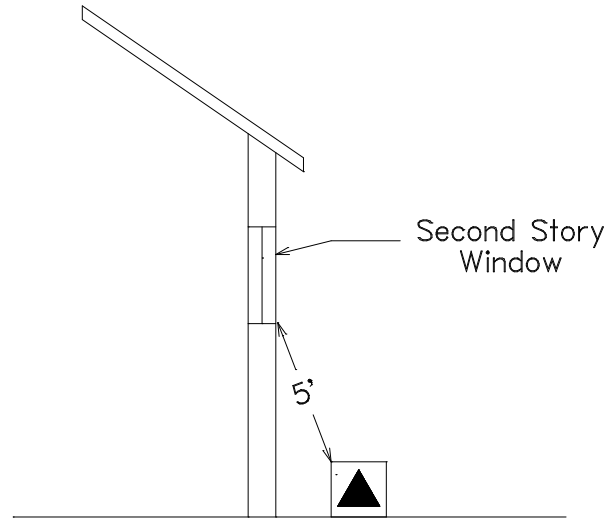

Figure PSC 114.317 B3b.

C. Combustible Walls

1. Padmounted oil-insulated transformers in sizes up to and including 100 kVA shall be located according to the provisions set forth in Subsection B for noncombustible walls.

2. Padmounted oil-insulated transformers in sizes above 100 kVA shall be located a minimum of 3.0 m (10 ft) from the building wall in addition to the clearances from building doors, windows and other openings set forth for noncombustible walls. Also, a sump shall be installed for transformers in size exceeding 500 kVA if the immediate terrain is pitched toward the building.

D. Barriers

If the clearances specified above cannot be obtained, a fire-resistant barrier may be constructed in lieu of the required separation. The following methods of construction are acceptable:

1. Noncombustible Walls

The barrier shall extend to a projection line from the corner of the padmounted transformer to the furthest corner of the window, door or opening in question. The height of the barrier shall be 0.3 m (1 ft) above the top of the padmounted transformer. See Figure PSC 114-317D1.

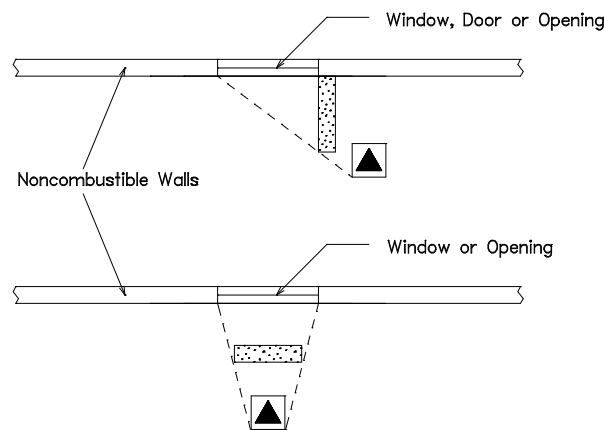

Figure PSC 114.317D1.

2. Combustible Walls

The barrier shall extend 0.9 m (3 ft) beyond each side of the pad-

mounted transformer. The height of the barrier shall be 0.3 m (1 ft) above the top of the transformer. See Figure PSC 114-317D2.

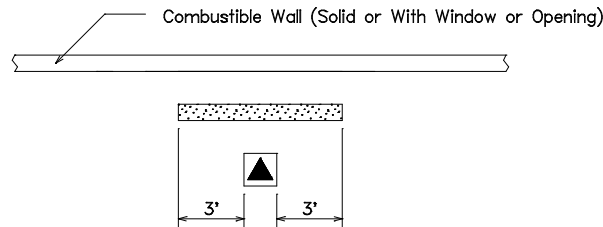

Figure PSC 114.317D2.

E. Fire Escapes

1. Padmounted oil-insulated transformers shall not be located within a zone extending 6.1 m (20 ft) outward and 3 m (10 ft) to either side of the point where a fire escape meets the ground. See Figure PSC 114-317E1.

2. Padmounted oil-insulated transformers located beneath fire escapes shall have a vertical clearance of not less than 3 m (10 ft) from the top of the transformer to the bottom of the fire escape. See Figure PSC 114-317E2.

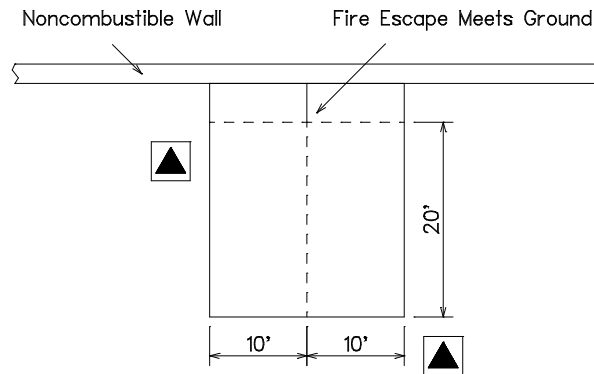

Figure PSC 114.317E1

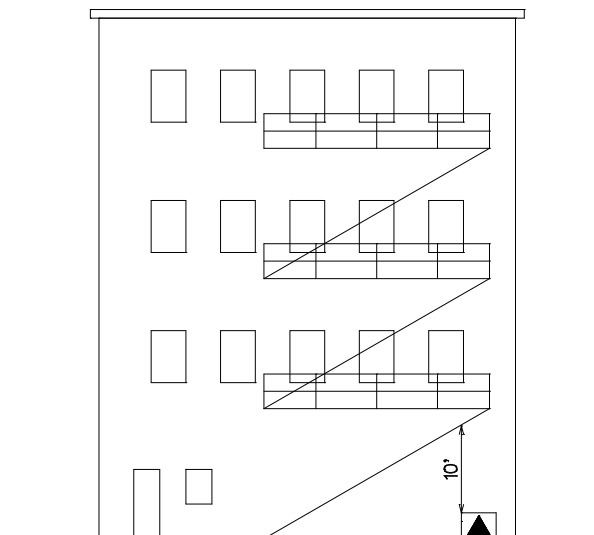

Figure PSC 114-317E2

History: Cr. Register, September, 1997, No. 501, eff. 10-1-97.

Section 32. Underground Conduit Systems

PSC 114.320B7 Separation from other underground installations. [Follows NESC 320B6, p. 177] Add the following paragraph 7:

7. Gas Lines

a. The separation in any direction of gas transmission lines from electric supply and communication conduit systems shall be a minimum of 0.3 m (12 in).

b. The separation in any direction of gas distribution or service lines from electric supply and communication conduit systems shall be a minimum of 0.15 m (6 in).

Exception: If these separations cannot be attained, the gas line must be protected from damage that might result from the proximity of the electric supply or communication conduit system.

Note: The definition of gas "transmission line," "distribution line," and "service line", as used herein, is the same as that found in s. PSC 135.09/192.3.

History: Cr. Register, September, 1997, No. 501, eff. 10-1-97.

Section 35. Direct-Buried Cable

PSC 114.352E Separations from other underground structures [Follows NESC 352D, p. 188]. Add the following paragraph E:

E. Gas Lines

The separation in any direction of gas pipelines from direct-buried electric supply and communication facilities shall be a minimum of 0.3 m (12 in).

Exception: If this clearance cannot be attained, the gas line shall be protected from damage that might result from the proximity of the electric supply or communication direct-buried system.

Table PSC 114.353-1 [NESC Table 353-1, p. 190] Supply Cable or Conductor Burial Depth (Change and Addition)

Change the present "Exception" after the table to "Exception 1".

Add a new Exception 2 as follows:

Exception 2: Installations of insulated secondary underground cables operating at less than 600 volts between conductors shall be permitted to be laid on the ground during winter months provided they are suitably protected.

History: Cr. Register, September, 1997, No. 501, eff. 10-1-97.

PSC 114.354D1g Random separation - additional requirements [NESC 354D1g, p. 190]. Change paragraph g to read:

g. Adequate bonding shall be provided between the effectively grounded supply conductor or conductors and the communication cable shield or sheath at intervals that should not exceed 300 m (1,000 ft). At each above or below grade transformer or above or below grade pedestal, all existing grounds shall be interconnected. These include the primary neutral, secondary neutral, power cable shield, metal duct, or sheath and communication cable sheath. Communication protectors, communication service cable shields and secondary neutrals shall be connected to a common ground at each customer's service entrance when commu-

nication circuits are underground without separation from power conductors.

History: Cr. Register, September, 1997, No. 501, eff. 10-1-97.

Section 38. Equipment

PSC 114.381H Warning signs [Follows NESC 381G, p. 194]. Add paragraph H to read:

H. Warning Signs

1. Where a padmounted transformer, switchgear, pedestal, or similar above-grade enclosure is not within a fenced or other protected area and contains live parts in excess of 600 volts, a permanent and conspicuous warning sign shall be provided on the outside of the enclosure which meets the requirements as to format and color of American National Standards Institute standard ANSI Z535-1991 for safety signs.

2. Electric supply equipment installed prior to the effective date of this chapter shall be signed to comply with these rules or the rule in effect in 1996. Warning signs installed as replacements or installed on new facilities shall comply with the standard as prescribed in s. PSC 114.381H 1 above. The "Mr. Ouch" symbol may be used as the optional pictorial part of this sign.

History: Cr. Register, September, 1997, No. 501, eff. 10-1-97.

Part 4. Rules for the Operation of Electrical Supply and Communications Lines and Equipment

Section 40. Purpose and Scope

PSC 114.402 Referenced sections [NESC 402, p. 197]. Change first sentence of Rule 402 to read:

The Introduction (Section 1) as amended by ss. PSC 114.001 to 114.007, Definitions (Section 2) as amended by Section 2 of Chapter PSC 114, List of Referenced Documents (Section 3) as amended by Section 3 of Chapter PSC 114, and Grounding Methods (Section 9) as amended by Section 9 of Chapter PSC 114, shall apply to the requirements of Part 4.

History: Cr. Register, September, 1997, No. 501, eff. 10-1-97; correction made under s. 13.93 (2m) (b) 7., Stats.

Section 44. Additional Rules for Supply Employees

PSC 114.444A3 De-energizing equipment or lines to protect employees-application of rule [NESC 444A3, p. 219]. Add the following Exception and Note to Rule 444A3:

Exception: This section does not apply to interactive installations of 20 kW or less.

Note: See ss. PSC 113.70(5) and PSC 113.73, Wis. Adm. Code.

History: Cr. Register, September, 1997, No. 501, eff. 10-1-97.