

Chapter Comm 82

APPENDIX

The material contained in this appendix is for clarification purposes only. The notes, illustrations, etc. are numbered to correspond to the number of the rule as it appears in the text of the code.

A-82.20 (2) AGENT MUNICIPALITIES. The department has designated the following municipalities the authority to review and approve plumbing plans and specifications for those plumbing installations located within the boundary limits of the municipality and which require approval under s. Comm 82.20.

Note: This list is maintained by the department and is subject to change.

<p><u>Appleton, City of</u> 100 N. Appleton St. Appleton, WI 54911-4799 Phone (920) 832-6419 FAX (920) 832-6464</p>	<p><u>Kenosha, City of</u> Dept. of Housing 625 52nd St., Rm. 100 Kenosha, WI 53144 Phone (262) 653-4263 FAX (262) 653-4254</p>
<p><u>Eau Claire, City of</u> 203 S. Farwell St. Eau Claire, WI 54702 Phone (715) 839-4947 FAX (715) 839-4939</p>	<p><u>Madison, City of</u> 215 Martin Luther King Jr. Blvd. PO Box 2984 Madison, WI 53701-2984 Phone (608) 266-4561 FAX (608) 266-6377</p>
<p><u>Green Bay, City of</u> 100 N. Jefferson St., Rm. 403 Green Bay, WI 54301 Phone (920) 448-3296 FAX (920) 448-3117</p>	<p><u>Milwaukee, City of</u> 809 N. Broadway St. Milwaukee, WI 53202 Phone (414) 286-3116 FAX (414) 286-8667</p>
<p><u>Greenfield, City of</u> 7325 W. Forest Home Ave. Greenfield, WI 53220 Phone (414) 329-5328 FAX (414) 543-9615</p>	<p><u>Oak Creek, City of</u> Public Works Inspection Div. 8640 S. Howell Ave. Oak Creek, WI 53154 Phone (414) 768-6547 FAX (414) 768-9587</p>
<p><u>Janesville, City of *</u> 18 N. Jackson St. P.O. Box 5005 Janesville, WI 53547-5005 Phone (608) 755-3064 FAX (608) 755-3196</p>	<p><u>Oshkosh, City of</u> 215 Church Ave. Oshkosh, WI 54901 Phone (920) 236-5052 FAX (920) 236-5084</p>
	<p><u>Sheboygan, City of</u> City Hall, 3rd Fl. 828 Center Ave. Sheboygan, WI 53081 Phone (920) 459-3478 FAX (920) 459-3967</p>

* Plans within this municipality may be submitted to the department or the agent.

A-82.20 (4) WATER QUALITY MANAGEMENT AGENCIES (WQM). The following is a list of water quality management agencies and the areas they serve.

Note: This listing is maintained by the department of natural resources and may be updated periodically; see also <http://www.dnr.state.wi.us/org/water/wm/glwsp/facilities/rpc.htm>.

AGENCY	AREAS SERVED
Bay-Lake Regional Planning Commission 211 N. Broadway, Suite 211 Green Bay, WI 54303-2757 Phone: (920) 448-2820	Cities of Manitowoc (est. completion 9/01), Marinette, Sheboygan, Sheboygan Falls, Two Rivers (est. completion 9/01) Village of Kohler Towns of Erdman, Herman, Lima, Mosel, Peshtigo, Porterfield, Sheboygan, Sheboygan Falls, Wilson
Brown County Planning Commission 100 N. Jefferson Street, Room 608 Green Bay, WI 54301 Phone: (920) 448-3400	County of Brown
City of Beaver Dam Beaver Dam Engineer 205 S. Lincoln Avenue Beaver Dam, WI 53916 (920) 887-4600 ext. 326	City of Beaver Dam
City of Monroe 1110 18 th Avenue Monroe, WI 53566 (608) 329-2595	City of Monroe
City of Superior Administrative Engineer 1407 Hammond Avenue Superior, WI 54880 Phone: (715) 394-0691	City of Superior
Dane County Regional Planning Commission 30 W. Mifflin Street, Suite 403 Madison, WI 53703 Phone: (608) 266-4137	County of Dane (scheduled to terminate 9/30/04)
Dunn County Land Conservation 390 Red Cedar Street Menomonie, WI 54751 Phone: (715) 232-1496	City of Menomonie (sanitary sewer extensions only)
East Central Wisconsin Regional Planning Commission 132 Main Street Menasha, WI 54952 Phone: (920) 751-4770	Counties of Calumet, Fond du Lac, Green Lake, Marquette, Menominee, Outagamie, Shawano, Waupaca, Waushara, Winnebago,
LaCrosse/Onalaska Office of City Engineer 400 LaCrosse Street LaCrosse, WI 54601 Phone: (608) 789-7505	Cities of LaCrosse, Onalaska Towns of Campbell, Shelby
Marathon County Planning Department 210 River Drive Wausau, WI 54403-5449 Phone: (715) 261-6040	Cities of Schofield, Wausau Towns of Maine, Stettin, Texas, Wausau, Weston "Rib Mountain Metropolitan Sewerage District"; "Wausau Urban Area" Towns of Kronenwetter, Rib Mountain, Rothchild Village of Weston
North Central Wisconsin Regional Planning Commission 407 Grant Street Wausau, WI 54403 Phone: (715) 261-6565	City of Merrill

AGENCY (cont.)	AREAS SERVED (cont.)
Oconto County/West Shore Oconto County Office of Land Use and Zoning 310 Washington Street Oconto, WI 54153-1621 Phone: (920) 834-6827	City of Oconto Towns of Abrams, Little River, Little Suamico, Oconto, Pensaukee, Stiles
Portage County Planning Department 1516 Church Street Stevens Point, WI 54481 Phone: (715) 346-1334	"Stevens Point Urban Area" City of Stevens Point Towns of Hull, Linwood, Plover Villages of Park Ridge, Plover, Whiting
River Falls Municipal Utilities 123 E. Elm Street Beaver Dam, WI 53916 (715) 425-0906	City of River Falls
Rock County Planning Agency 51 South Main Street Janesville, WI 53545 Phone: (608) 757-5587	Cities of Janesville and Beloit Towns of Beloit, Harmony, LaPrairie, Janesville, Rock, Turtle Village of Chilton
Sauk County Planning and Zoning 505 Broadway Baraboo, WI 53913 (608) 355-3285	City of Baraboo
Southeastern Wisconsin Regional Planning Commission W239 N1812 Rockwood Drive P. O. Box 1607 Waukesha, WI 53187-1607 Phone: (414) 547-6721	Counties of Kenosha, Milwaukee, Ozaukee, Racine, Walworth, Washington, Waukesha
St. Croix County Planning Office 1101 Carmichael Road Hudson, WI 54016 Phone: (715) 286-4673	"Hudson Urban Area" City of Hudson Towns of Hudson, St. Joseph, Troy Villages of North Hudson, Western 1/2 Town of Warren
Sturgeon Bay Utilities Utilities General Manager P.O. Box 259 230 East Vine Street Sturgeon Bay, WI 54235 Phone: (920) 746-2820	City of Sturgeon Bay
West Central Wisconsin Regional Planning Commission 800 Wisconsin Street, Mailbox 9 Eau Claire, WI 54703-3606 Phone: (715) 836-2918	"Chippewa-Eau Claire Metropolitan Planning Area" Cities of Altoona, Chippewa Falls, Eau Claire Towns of Brunswick, Hallie, Lafayette, Seymour, Tilden, Union, Washington
Wood County Planning 400 Market Street Wisconsin Rapids, WI 54495 Phone: (715) 421-8466	"Southern Wood County" Cities of Marshfield, Nekoosa, Wisconsin Rapids Towns of Cameron, Grand Rapids, Lincoln, Marshfield, McMillan, Port Edwards, Rudolph, Saratoga, Seneca, Sigel, Grant Villages of Biron, Hewitt, Port Edwards, Rudolph

A-82.30 (4)-1. BRANCH INTERVALS.

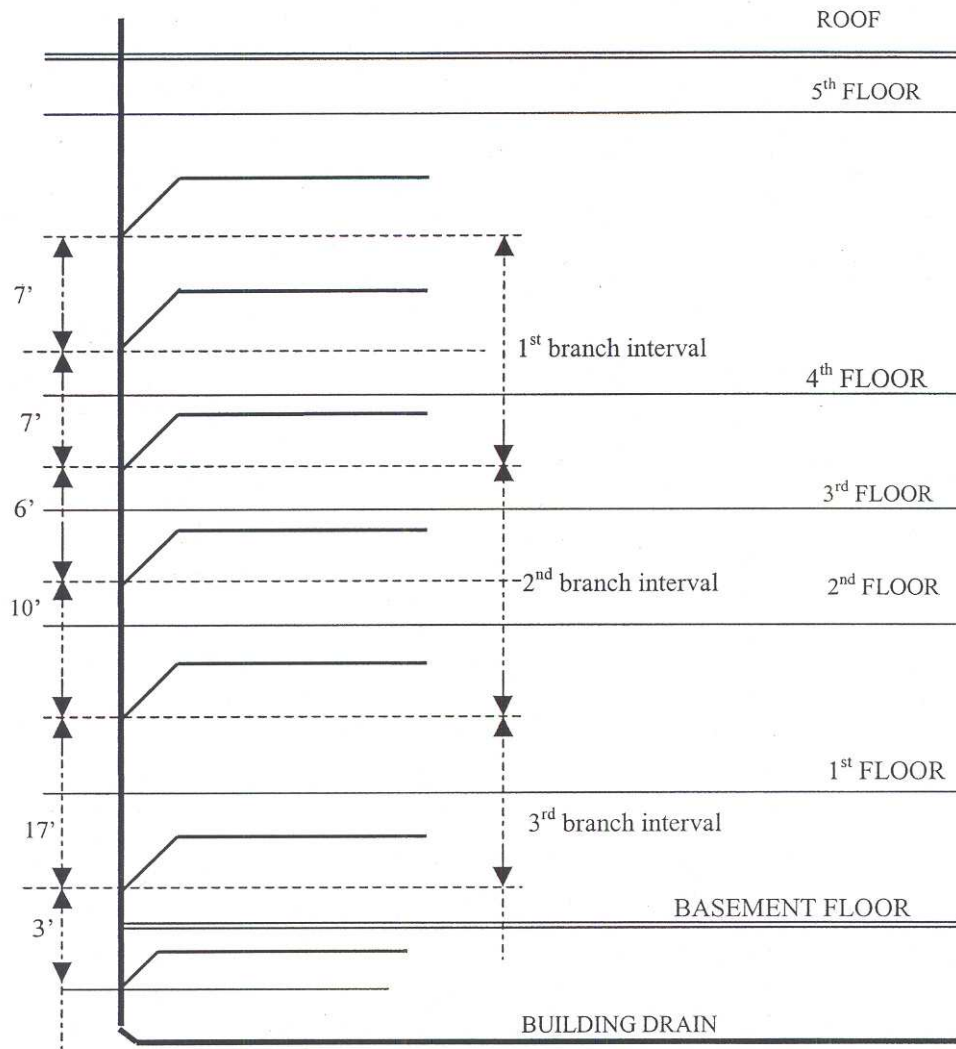

A-82.30 (4)-2. RECEPTOR DESIGN. The following table lists the gallons per minute (GPM) which can be expected to readily flow through a given size trap where the receptor has a height (H) as indicated.

Also listed is a drainage fixture unit (dfu) load which a given size receptor trap may be expected to adequately receive.

Note: A minimum individual 4-inch diameter trap and drain for a commercial type dishwasher is recommended.

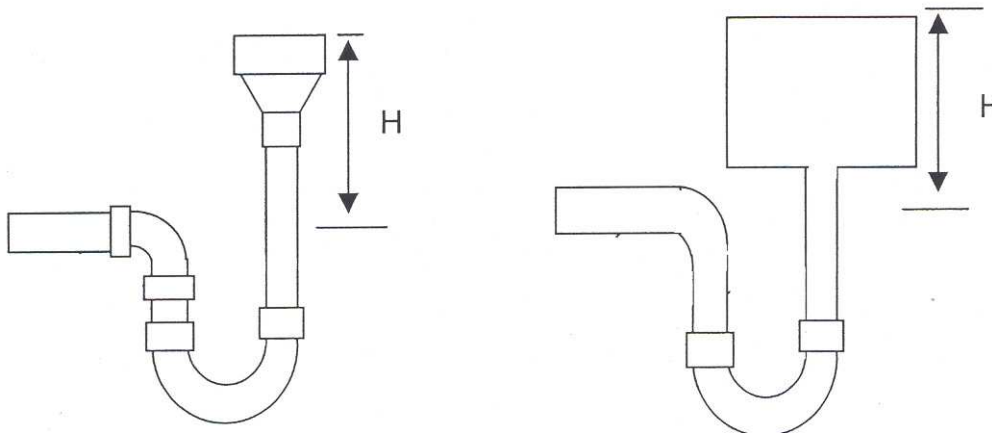

Receptor Trap Size (in inches)	H (in inches)	GPM	Drainage Fixture Units (dfu)
1 1/2	12	4	2
2	14	8	4
3	15	12	6
4	17	40	20
5	20	70	35
6	22	120	60
8	25	250	125

A-82.30 (4)-3. Section NR 110.13 (2) (c) reads: “NR 110.13 (2) (c) *Slope*. 1. Conventional gravity sewers shall be laid with uniform slope between manholes. All sewers shall be designated and constructed to give average velocities of not less than 60 centimeters per second (2.0 feet per second) when flowing full. The minimum slopes in Table 1 shall be provided. Slopes less than 0.4% may be permitted for 20 centimeter (8 inch) sewers. In such cases, however, the slope may not be less than 0.3%. The department (DNR) will approve these sewers only when the owner demonstrates that physical circumstances warrant the lesser slope. Furthermore, approval will not be granted until the department (DNR) has received written assurance from the operating authority that the authority will provide the additional maintenance which may result from the sedimentation due to decreased velocities.”

NR 110 Table 1

Sewer Size (in inches)	Minimum Slope (ft./100 ft.)
8 (20 cm)	0.40
10 (25 cm)	0.28
12 (30 cm)	0.22
15 (38 cm)	0.15
18 (46 cm)	0.12
21 (53 cm)	0.10
24 (61 cm)	0.08

A-82.30 (6) (b) OFFSETS IN VERTICAL DRAINS.

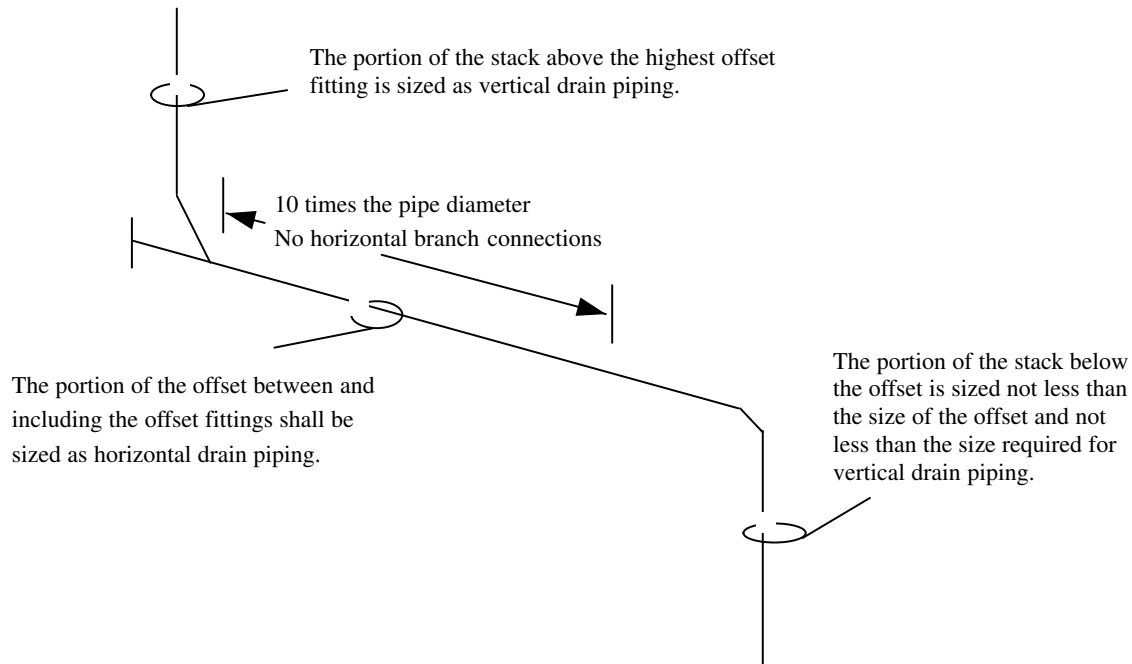

A-82.30 (7) HORIZONTAL BRANCH DRAIN CONNECTION AT BASE OF A STACK.

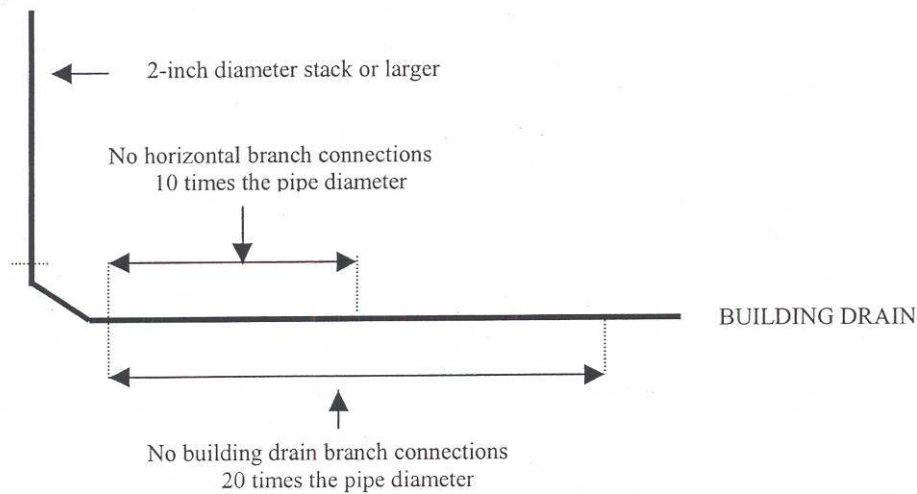

A-82.30 (8) MEASURING RADIUS OF A FITTING.

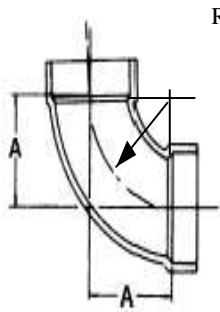

Radius of a plastic DWV fitting

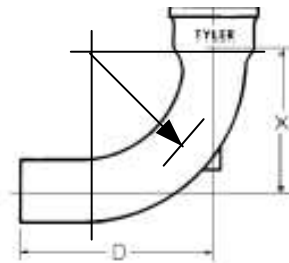

Radius of hub & spigot fitting

A-82.30 (10) (a) DETERMINING REQUIRED CAPACITY OF SANITARY SUMP.

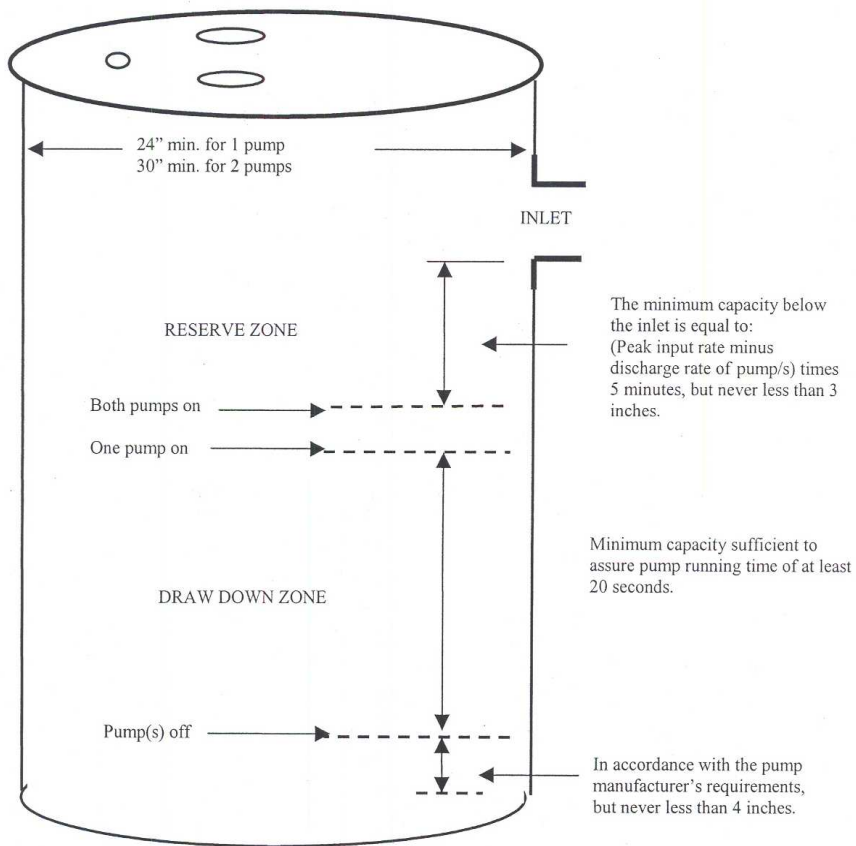

A-82.30 (1) (a) SUMPS.

**Capacity of sumps
(in gallons)**

Diameter of sump in inches	Volume in gal/ft	Diameter of sump in inches	Volume in gal/ft
24	23.5	41	68.6
25	25.5	42	72.1
26	27.6	43	75.5
27	29.7	44	79.1
28	32.0	45	82.7
29	34.3	46	86.5
30	36.8	47	90.2
31	39.2	48	94.0
32	41.8	54	119.0
33	44.5	60	147.0
34	47.2	66	178.0
35	50.0	72	211.5
36	52.8	78	248.4
37	55.9	84	288.1
38	59.0	90	330.8
39	62.1	96	376.3
40	65.3	108	477.3

A-82.30 (10) (b) 3. VELOCITY AND FLOW RELATIONSHIP MAINTAINING 2 FEET PER SECOND.

Schedule 40 PVC

VELOCITY AND FLOW RELATIONSHIP MAINTAINING 2 FEET PER SECOND

Nominal Inside Diameter (in inches)	Actual Inside Diameter (in inches)	GPM creating 2 ft. per second
1 ¹ / ₄	1.38	9
1 ¹ / ₂	1.61	13
2	2.067	21
3	3.068	46
4	4.026	79

A-82.30 (11) (b) BUILDING DRAINS SERVING ANY BUILDING.

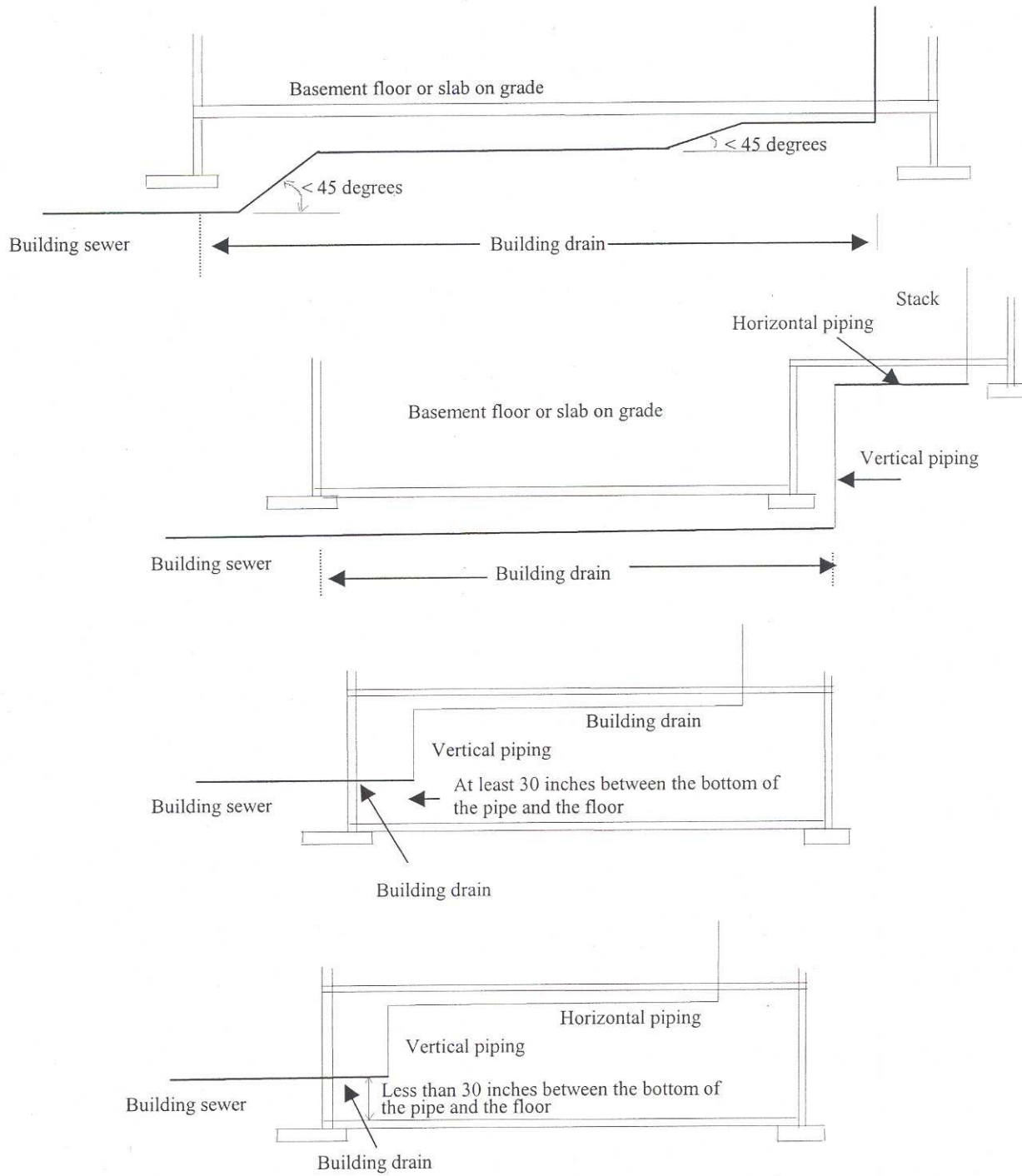

A-82.30 (11) (c) BUILDING SEWER INSULATION.

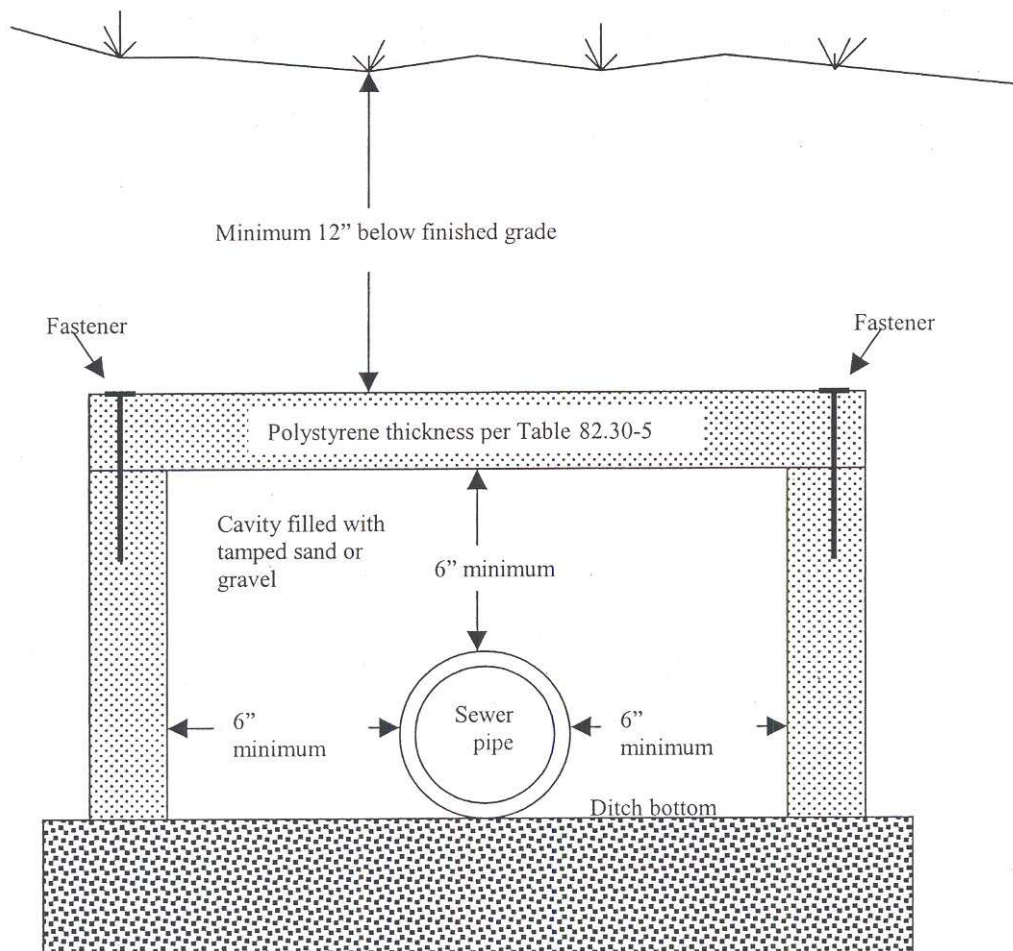

A-82.30 (11) (d) SETBACKS FOR VARIOUS CONTAMINANT SOURCES. Setbacks for various contaminant sources as specified in chs. NR 811 and NR 812 read:

“NR 811.16 (4) The well site shall be adequately separated from potential sources of contamination. Unless a hydrogeologic investigation indicates lesser separation distances would provide adequate protection of a well from contamination, the minimum separation distances provided shall be:

1. Fifty feet between a well and a storm sewer main.
2. Two hundred feet between a well and any sanitary sewer main, lift station or single family fuel tank. A lesser separation distance may be allowed for sanitary sewer mains where the sanitary sewer main is constructed of water main materials and joints and pressure tested in place to meet current AWWA C600 specifications. In no case may the separation distance between a well and a sanitary sewer main be less than 50 feet.
3. Four hundred feet between a well and a septic tank or soil adsorption unit receiving less than 8,000 gallons per day, a cemetery or a storm water drainage pond.
4. Six hundred feet between a well and any gasoline or fuel oil storage tank installation that has received written approval from the Department of Commerce or its designated agent under s. Comm 10.10.
5. One thousand feet between a well and land application of municipal, commercial or industrial waste; the boundaries of a land-spreading facility for spreading of petroleum-contaminated soil regulated under ch. NR 718 while that facility is in operation; industrial, commercial or municipal waste water lagoons or storage structures; manure stacks or storage structures; and septic tanks or soil adsorption units receiving 8,000 gallons per day or more.
6. Twelve hundred feet between a well and any solid waste storage, transportation, transfer, incineration, air curtain destructor, processing, wood burning, one time disposal or small demolition facility; sanitary landfill; any property with residual ground-water contamination that exceeds ch. NR 140 enforcement standards that is shown on the department’s geographic information system registry of closed remediation sites; coal storage area; salt or deicing material storage area; gasoline or fuel oil storage tanks that have not received written approval from the department of industry, labor and human relations or its designated agent under s. Comm 10.10; bulk fuel storage facilities; and pesticide or fertilizer handling or storage facilities.

Note: Sites that have been closed with groundwater enforcement standard exceedances can be found on the Department of Natural Resource's GIS Registry of Closed Remediation Sites, at <http://www.dnr.state.wi.us/org/aw/rr> on the DNR's internet site. Information that appears on the GIS Registry of Closed Remediation Sites can also be accessed by calling the nearest regional DNR office."

NR 812.08 (4) RELATION TO CONTAMINATION SOURCES. Minimum separating distances between any new potable or non-potable well, reservoir or spring and existing sources of contamination; or between new sources of contamination and existing potable or nonpotable wells, reservoirs or springs shall be maintained as described in this subsection. The minimum separating distances of this subsection do not apply to dewatering wells approved under s. NR 812.09 (4) (a). Greater separation distances may be required for wells requiring plan approval under s. NR 812.09. Separation distance requirements to possible sources of contamination will not be waived because of property lines. Minimum separating distances are listed in Table A and are as follows:

(a) Eight feet between a well or reservoir and a:

1. Buried gravity flow sanitary or storm building drain having pipe conforming to ch. Comm 84;
2. Buried gravity flow sanitary or storm building sewer having pipe conforming to ch. Comm 84;
3. Watertight clear water waste sump;
4. Buried clear water waste drain having pipe conforming to ch. Comm 84;
5. Buried gravity flow foundation drain;
6. Rainwater downspout outlet;
7. Cistern;
8. Buried building foundation drain connected to a clear water waste drain or other subsoil drain;
9. Noncomplying pit, subsurface pumphouse, alcove, or reservoir;
10. Nonpotable well;
11. Fertilizer or pesticide storage tank with a capacity of less than 1,500 gallons, but only when the well is nonpotable;

Note: For potable wells see par. (d) 1.

12. Plastic silage storage and transfer tube;
13. Yard hydrant;
14. Swimming pool, measured to the nearest edge of the water; or
15. Dog or other small pet house, animal shelter or kennel housing not more than 3 adult pets on a residential lot.

(b) Twenty-five feet between a well or reservoir and a:

1. Buried grease interceptor or trap;
2. Septic tank;
3. Holding tank;
4. Buried building drain or building sewer having pipe not conforming to ch. Comm 84, wastewater sump, or non-watertight clear water waste sumps;
5. Buried pressurized sanitary building sewer having pipe conforming to ch. Comm 84;
6. Buried gravity manure sewer;
7. Lake, river, stream, ditch or stormwater detention pond or basin measured to the regional high water elevation in the case of a lake or stormwater detention pond, to the edge of the floodway in the case of a river or stream or to the edge in the case of a ditch or stormwater detention basin;
9. Liquid-tight barn gutter;
10. Animal barn pen with concrete floor;
11. Buried pressurized sewer pipe conveying manure provided that the pipe meets ASTM specification D-2241, with standard dimension ratio of 21 or less or pressure pipe meeting the requirements of s. NR 110.13 (6) (f) or 811.62.
12. Buried fuel oil tanks serving single family residences, including any associated buried piping;
13. Discharge to ground from a water treatment device;
14. Vertical shaft installed below grade used for intake of air for a heating or air conditioning system; or
15. Buried sanitary or storm collector sewer serving 4 or fewer living units or having a diameter of 6 inches or less.

(c) Fifty feet between a well or reservoir and a:

1. Soil absorption unit receiving less than 8,000 gallons/day, existing, abandoned or alternate, but not including a school soil absorption unit;

Note: For school soil absorption units see par. (e); for soil absorption units receiving more than 8,000 gallons/day see par. (f) 3.

2. Privy;
3. Pet waste pit disposal unit;
4. Animal shelter;
5. Animal yard;
6. Silo;
7. Buried sewer used to convey manure having pipe conforming to ch. Comm 84 that does not meet the specifications in par. (b);
8. Liquid tight manure hopper or reception tank;
9. Filter strip;

10. Buried sanitary or storm collector sewer serving more than 4 living units or larger than 6 inches in diameter except that wells may be located or sewers installed such that a well is less than 50 feet, but at least 25 feet, from gravity collector sewers smaller than 16 inches in diameter or from force main collector sewers 4 inches or smaller in diameter provided that within a 50-foot radius of the

well the installed sewer pipe meets the allowable leakage requirements of AWWA C600 and the requirements for water main equivalent type pipe as follows:

a. For sewers >4" diameter, but <16" diameter: PVC pipe >4" diameter, but <12" diameter shall meet AWWA C900 with elastomeric joints having a standard dimension ratio of 18 or less; PVC pipe >12" diameter, but <16" diameter shall meet AWWA C905 with elastomeric joints having a standard dimension ratio of 18 or less; Ductile iron pipe shall meet AWWA C115 or AWWA C151 having a thickness class 50 or more.

b. For sewers <3" diameter, the pipe shall be any rigid pipe in the ch. Comm 84 "Table for Pipe and Tubing for Water Services and Private Water Mains," including approved ABS, brass, cast iron, CPVC, copper (not including type M copper) ductile iron, galvanized steel, polybutylene (PB), polyethylene (PE), PVC, or stainless steel pipe.

11. An influent sewer to a wastewater treatment plant;
12. The nearest existing or future grave site in cemeteries;
13. Wastewater treatment plant effluent pipe;
14. Buried pressurized sewer having pipe not conforming to ch. Comm 84; or
15. Manure loading area.

Note: The minimum separating distance between a well or reservoir and a lift station is based on the presence of a sewer force main at the lift station.

(d) One hundred feet between a well or reservoir and a:

1. Bulk surface storage tank with a capacity greater than 1,500 gallons or any bulk buried storage tank regardless of capacity, including, for both surface or buried tanks, associated buried piping for any solid, semi-solid or liquid product but not including those regulated under par. (b) 12. This subdivision includes, but is not limited to petroleum product tanks, waste oil tanks and pesticide or fertilizer storage tanks not regulated under par. (a) 11. This subdivision does not include septic, holding and manure reception tanks, or liquified petroleum gas tanks as specified in ch. Comm 11.

2. Liquid-tight, fabricated manure or silage storage structure, in ground or at ground surface;
3. Wastewater treatment plant structure, conveyance or treatment unit; or
4. Dry fertilizer or pesticide building or area when more than 100 pounds of either or both materials are stored;
5. Well, drill hole or water system used for the underground placement of any waste, surface or subsurface water or any substance as defined in s. 160.01 (8), Stats.;
6. Stormwater infiltration basin;
7. Uncovered storage of silage on the ground surface;
8. Water-tight silage storage trench or pit; or
9. Lift station.

(e) Two hundred feet between a school well and a soil absorption unit receiving less than 8,000 gallons per day, existing or abandoned.

(ee) One hundred fifty feet between a well or reservoir and a temporary manure stack.

(f) Two hundred fifty feet between a well or reservoir and a:

1. Manure stack.
2. Earthen or excavated manure storage structure.

Note: Variances from the separating distances may be granted as specified in s. NR 812.43 for earthen storage and manure stacks constructed and maintained to the specifications of Soil Conservation Standards No. 425 or 312, respectively.

3. Soil absorption unit receiving 8,000 or more gallons per day, existing, abandoned, or alternate.
4. Sludge landspreading or drying area.
5. An earthen silage storage trench or pit.
6. Liquid waste disposal system including, but not limited to a treatment pond or lagoon, ridge and furrow system and spray irrigation system.

Note: Variance from this separating distance may be granted for treatment ponds r lagoons constructed and maintained to an approval granted under ch. NR 213.

7. Salvage yard.
8. A salt or deicing material storage area including the building structure and the surrounding area where the material is transferred to vehicles. This subdivision does not include bagged deicing material.
9. Solid waste processing facility.
10. Solid waste transfer facility.
11. The boundaries of a landspreading facility for spreading of petroleum-contaminated soil regulated under ch. NR 718 while that facility is in operation.

(g) Twelve hundred feet between a well or reservoir and:

1. The nearest edge of an existing, proposed or abandoned landfill, measured to the nearest fill area of abandoned landfills, if known, otherwise measured to the nearest property line;
2. The nearest edge of a coal storage area in excess of 500 tons; or
3. A hazardous waste treatment facility regulated by the department."

A-82.30 (11) (f) CONNECTION TO PRESSURIZED PUBLIC SEWER.

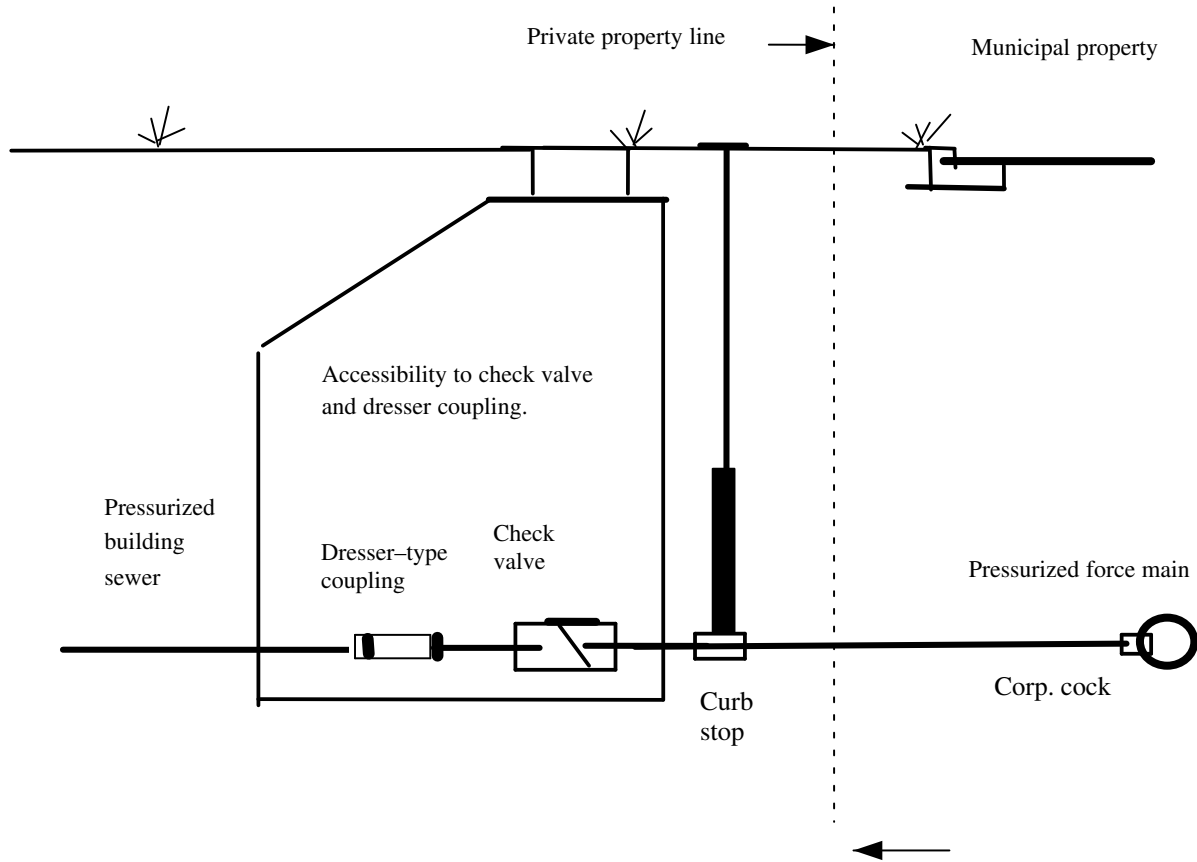

A-82.30 (11) (h) LOCATING REQUIREMENTS – TRACER WIRE INSTALLATION.

Tracer wire installation

1. The jacket of the tracer wire must be watertight over the entire buried length. Moisture in contact with the wire causes corrosion and eventual failure of the tracer wire.
2. Splices in the tracer wire must be watertight.
3. Attaching a small Magnesium “pencil” anode to the tracer wire will help protect the wire from corrosion. The anode should be in an accessible location, like where the tracer wire comes to ground level. When locating the pipe, the tracer wire may be disconnected from the anode and the anode serves as a good ground connection for the second lead of the transmitter.

The following diagram illustrates a typical tracer wire installation for sanitary sewer.

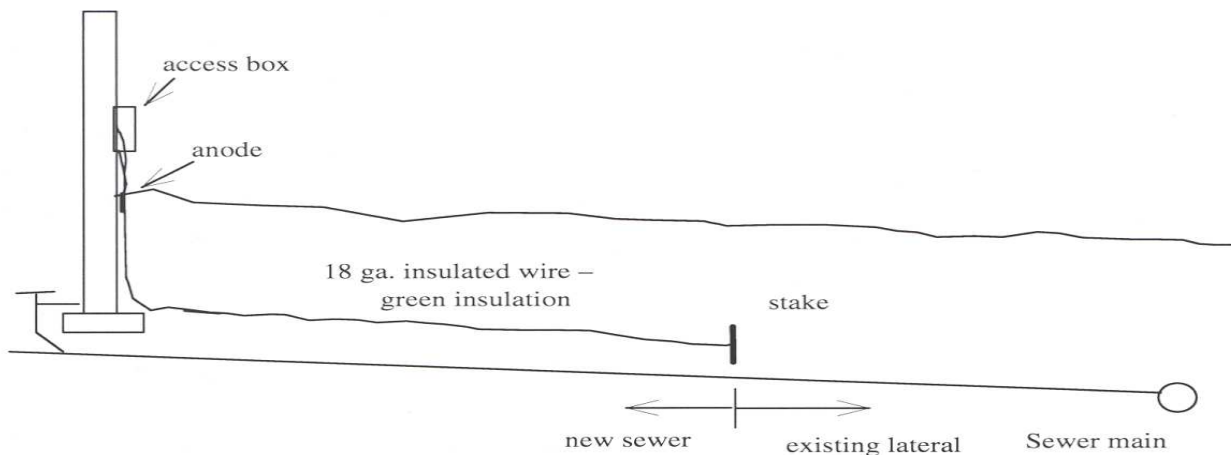

A-82.31 (4)-1. WHERE A VENT STACK AND STACK VENT ARE REQUIRED.

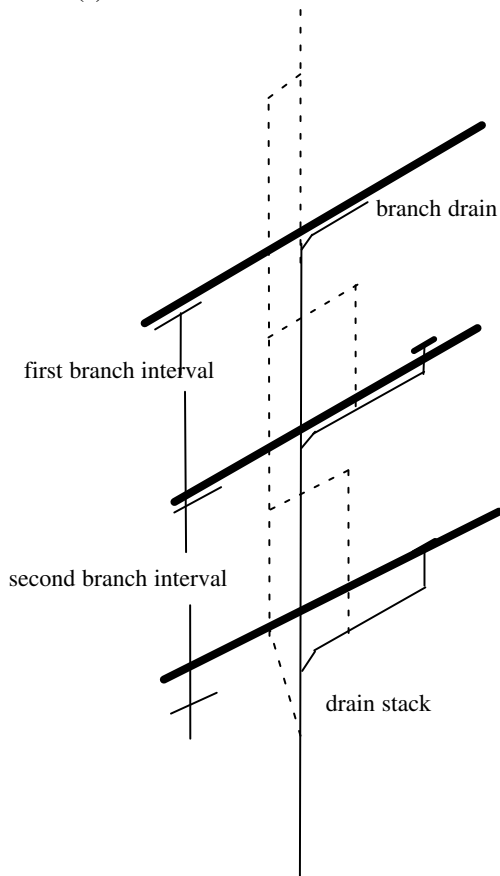

A-82.31 (4)-2. INSTALLATION OF VENT STACK AND STACK VENT.

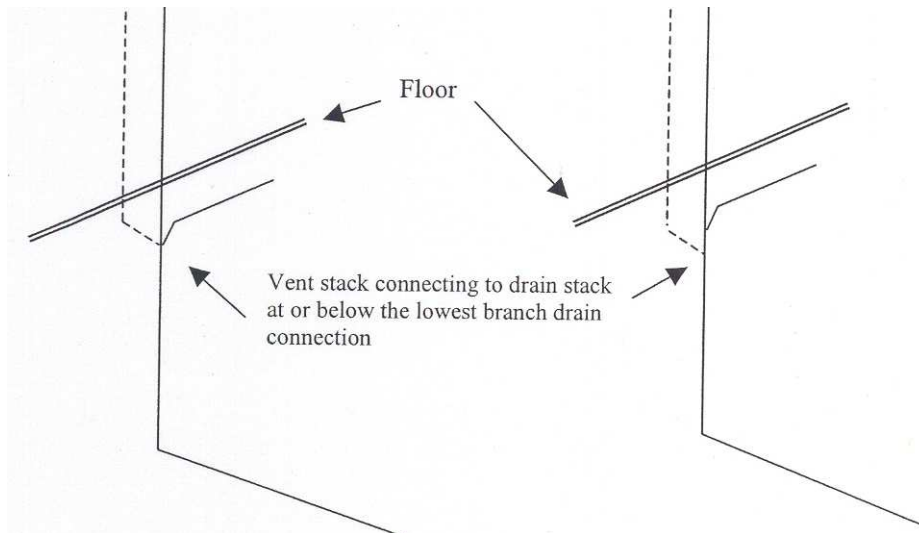

A-82.31 (4)-3. VENT STACKS AND STACK VENTS.

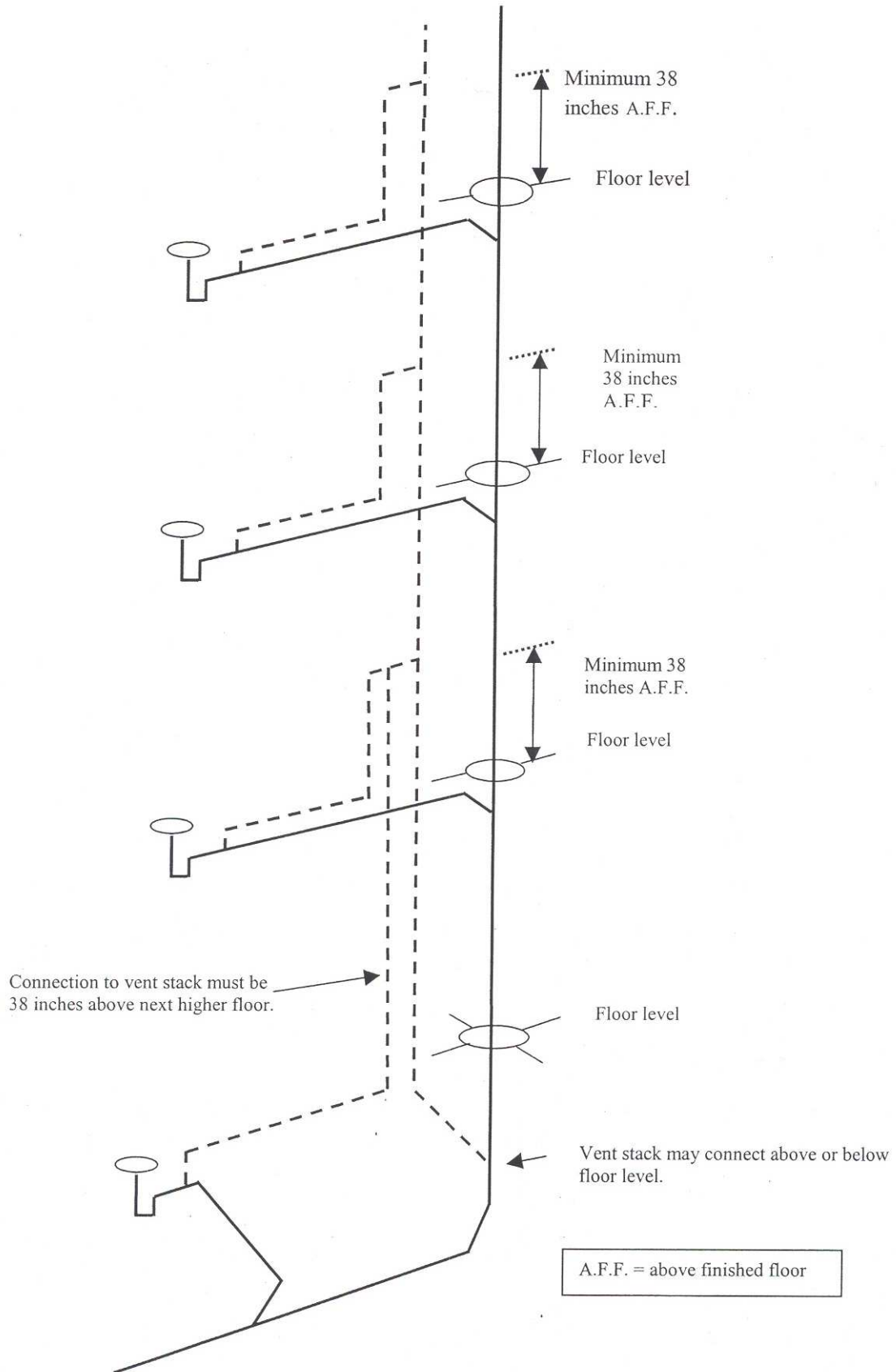

A-82.31 (4)-4. VENT STACKS AND STACK VENTS.

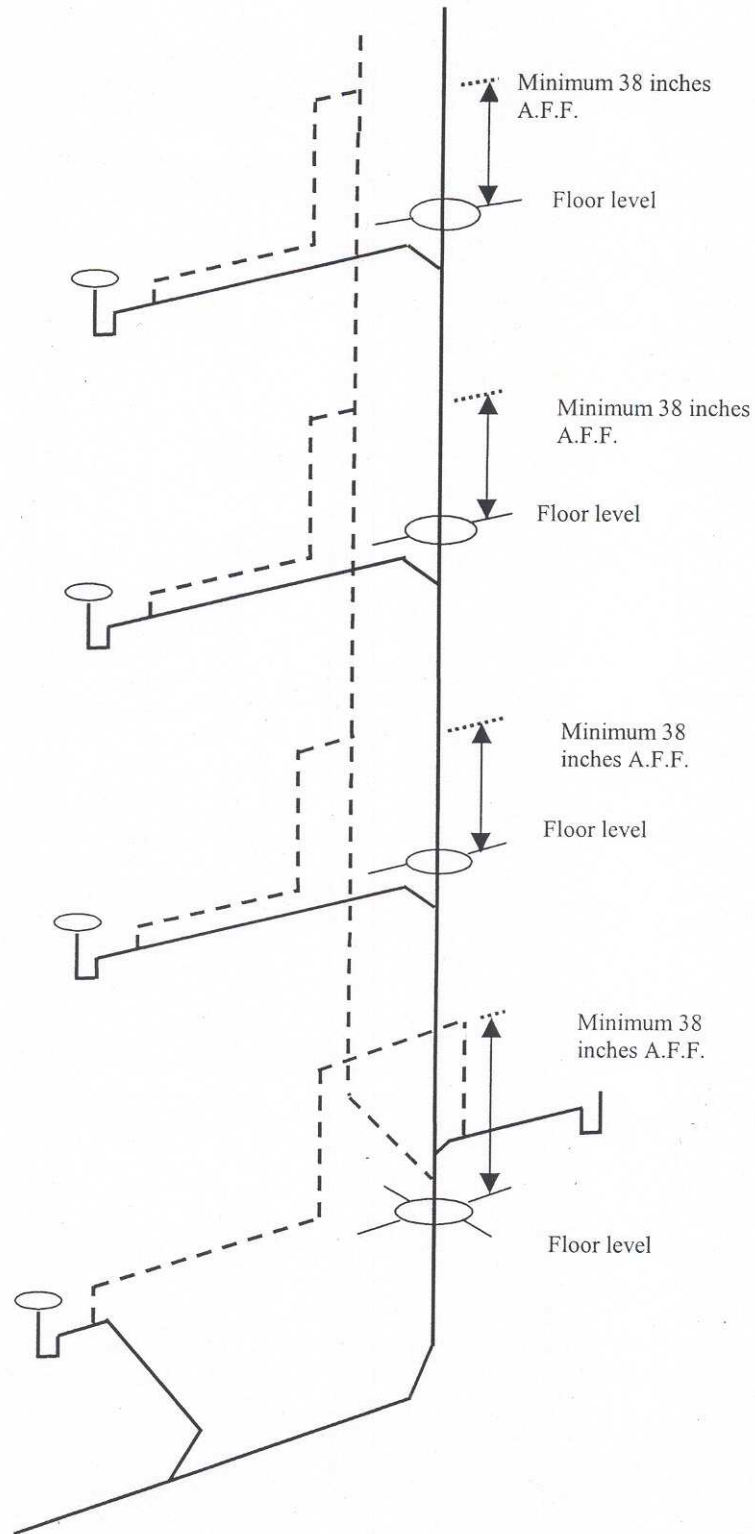

A-82.31 (4)-5. VENTS STACKS AND STACK VENTS.

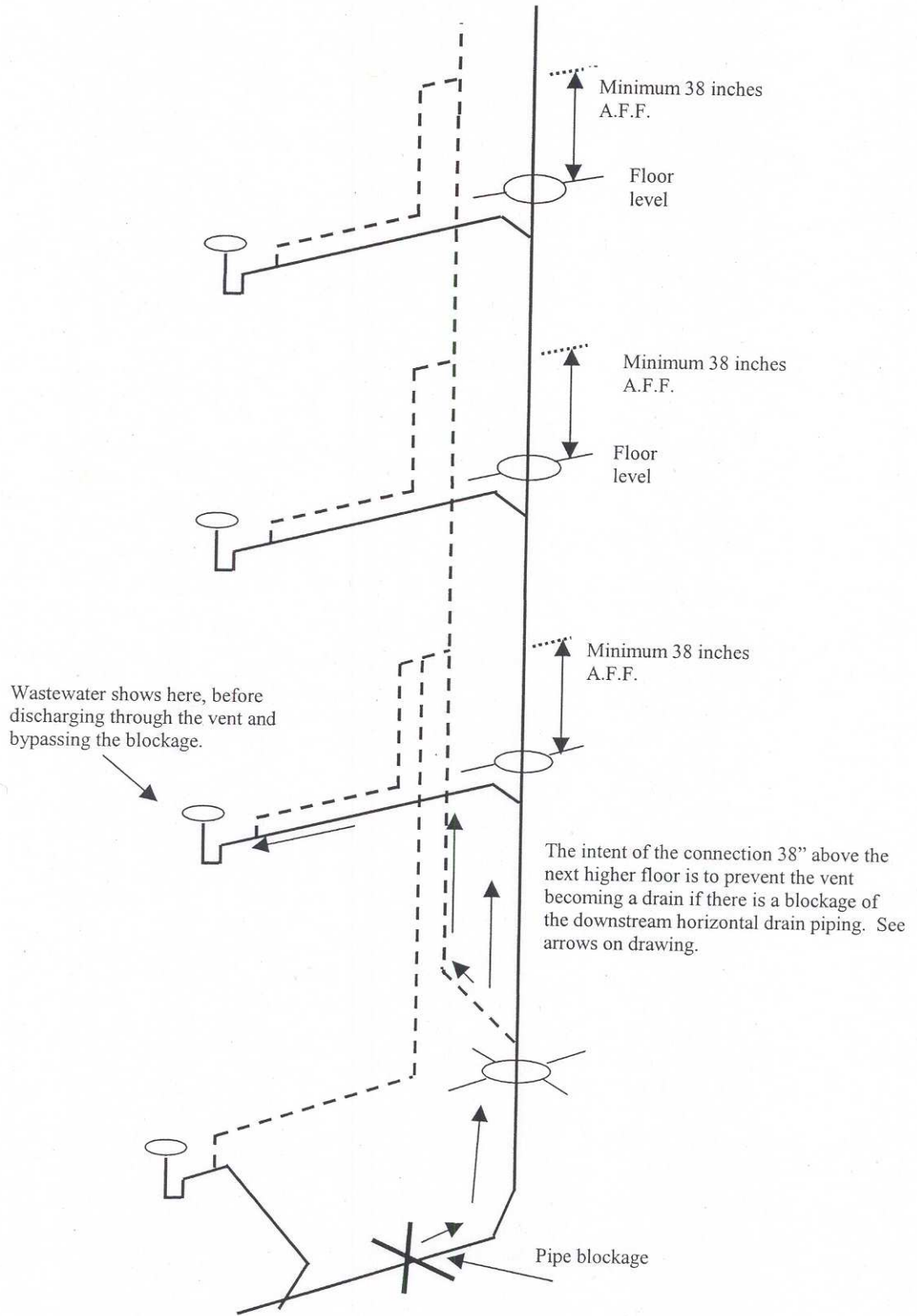

A-82.31 (5) (a) RELIEF VENT FOR OFFSETS OF 30 TO 45 DEGREES.

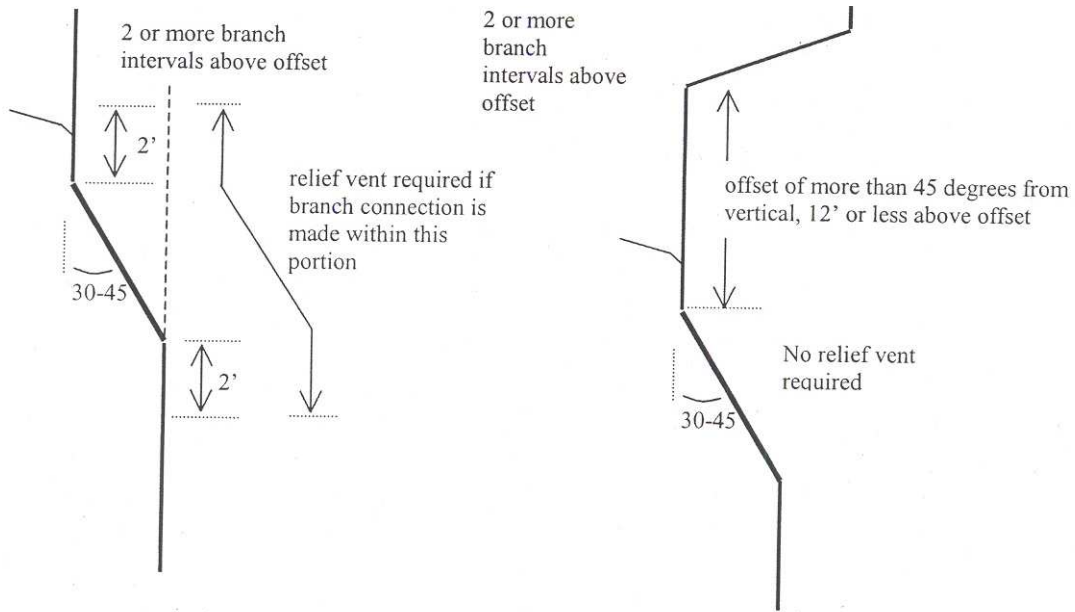

A-82.31 (5) (b) RELIEF AND YOKE VENTS FOR OFFSETS OF MORE THAN 45 DEGREES.

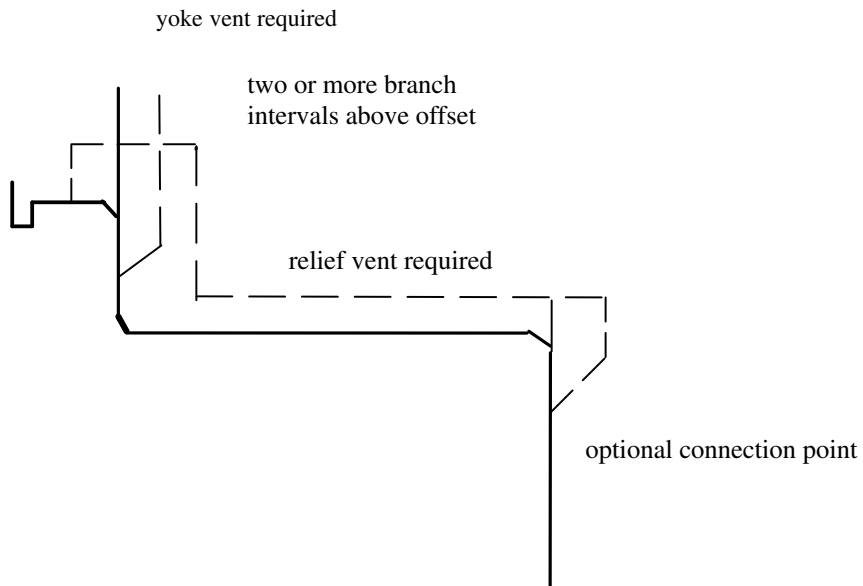

A-82.31 (7) RELIEF VENTS FOR BUILDING DRAINS.

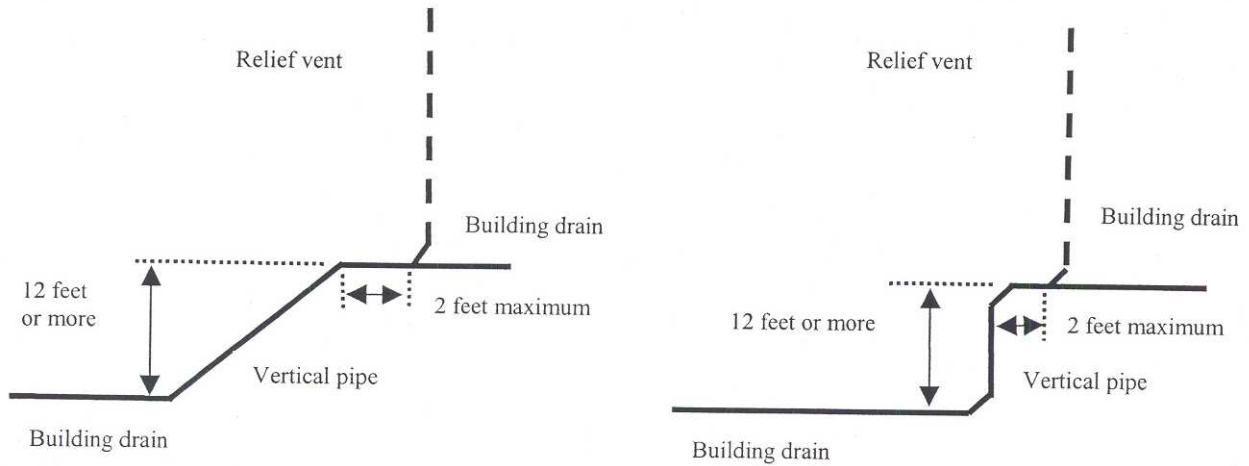

A-82.31 (9) FIXTURE VENTS.

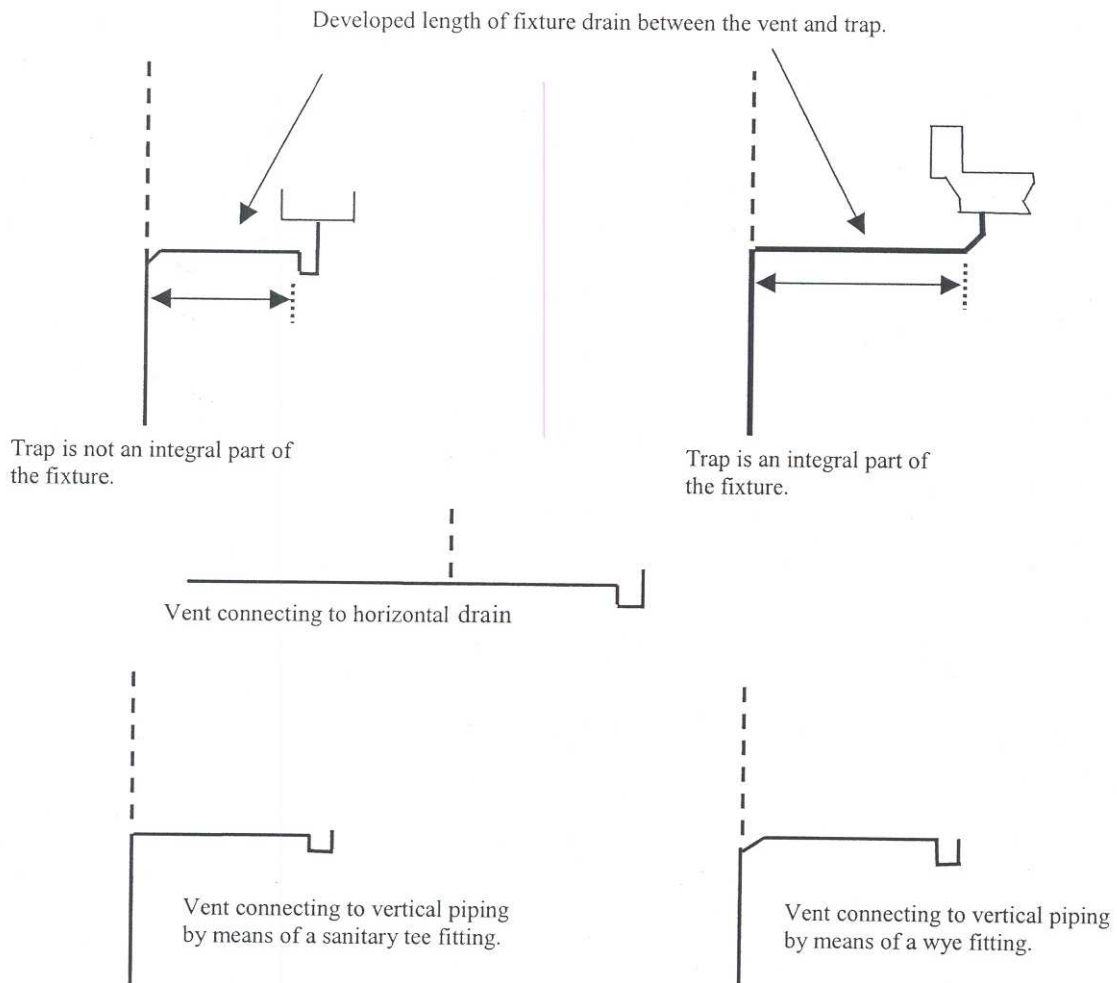

A-82.31 (10)-1. CIRCUIT VENTING.

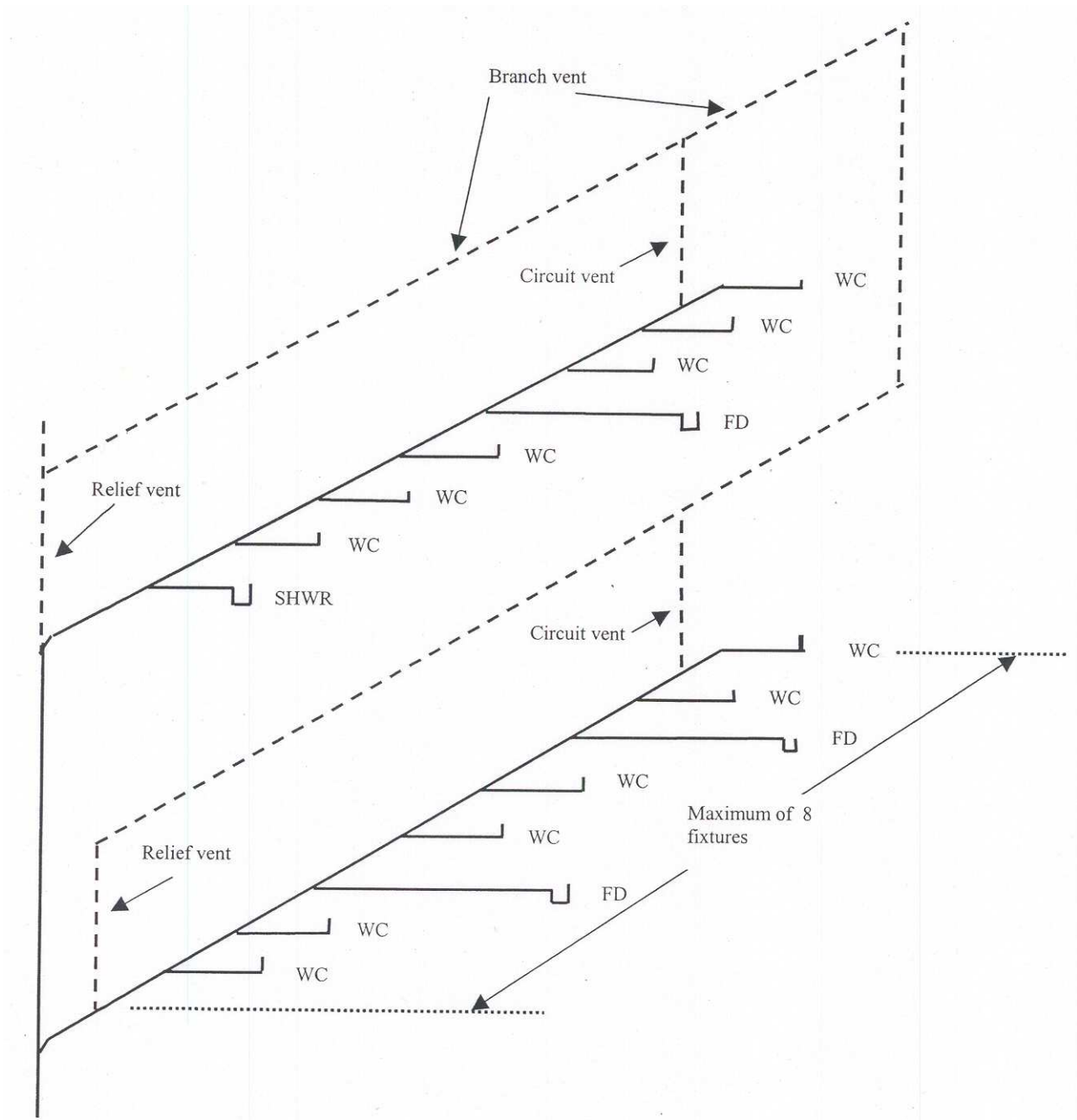

A-82.31 (10)-2. CIRCUIT VENTING.

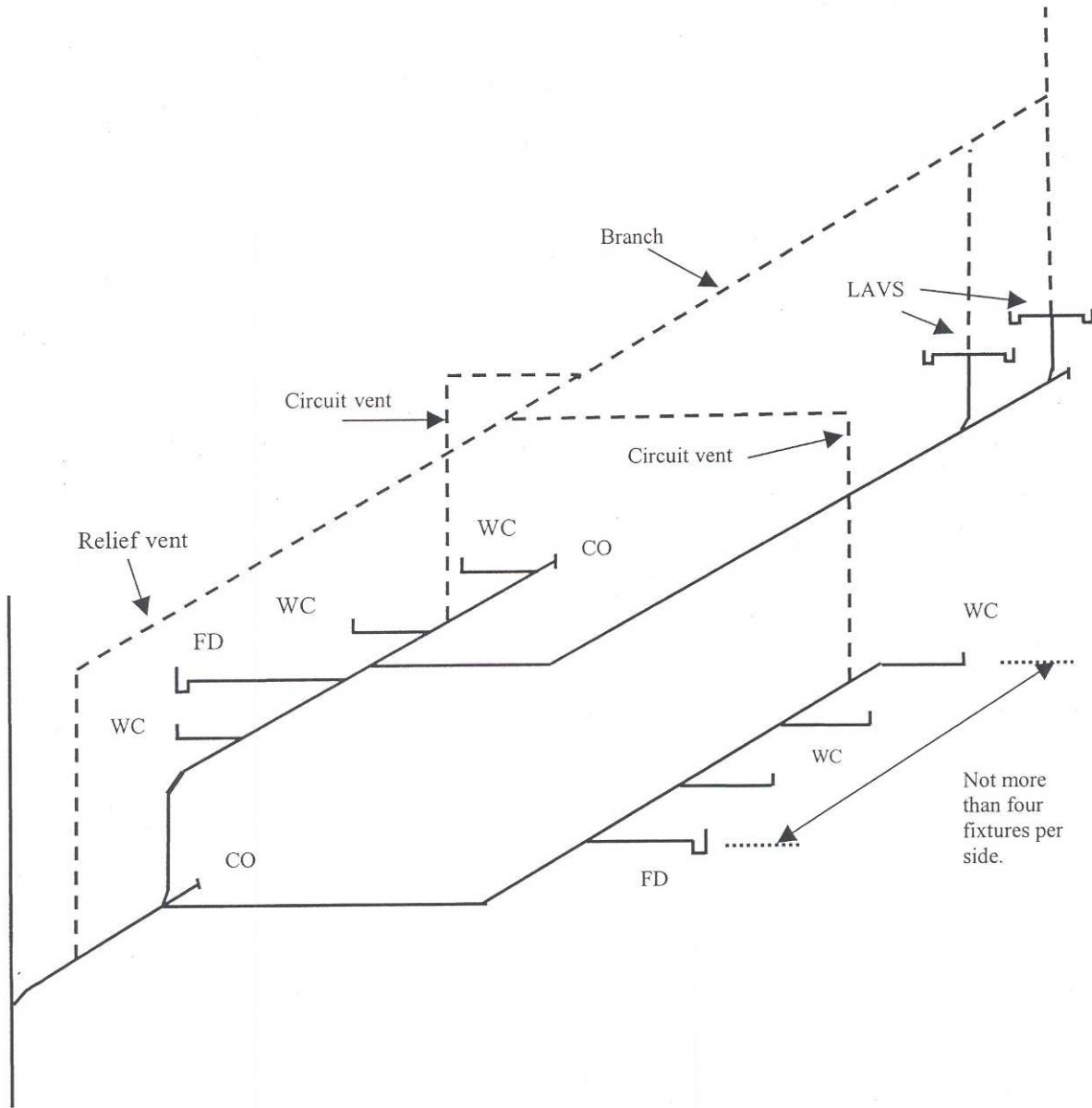

A-82.31 (10)-3. CIRCUIT VENTING.

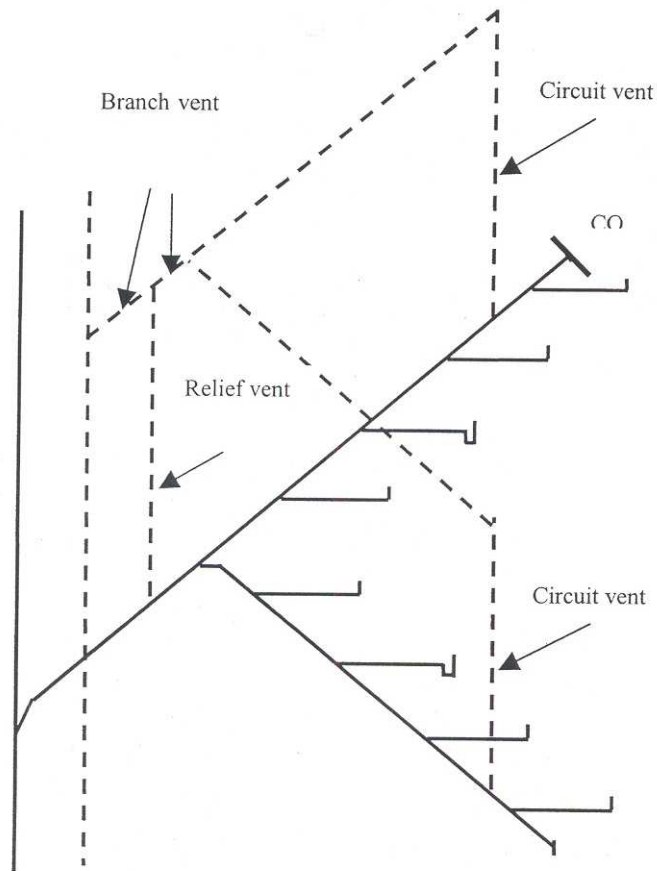

A-82.31 (10)-4. CIRCUIT VENTING.

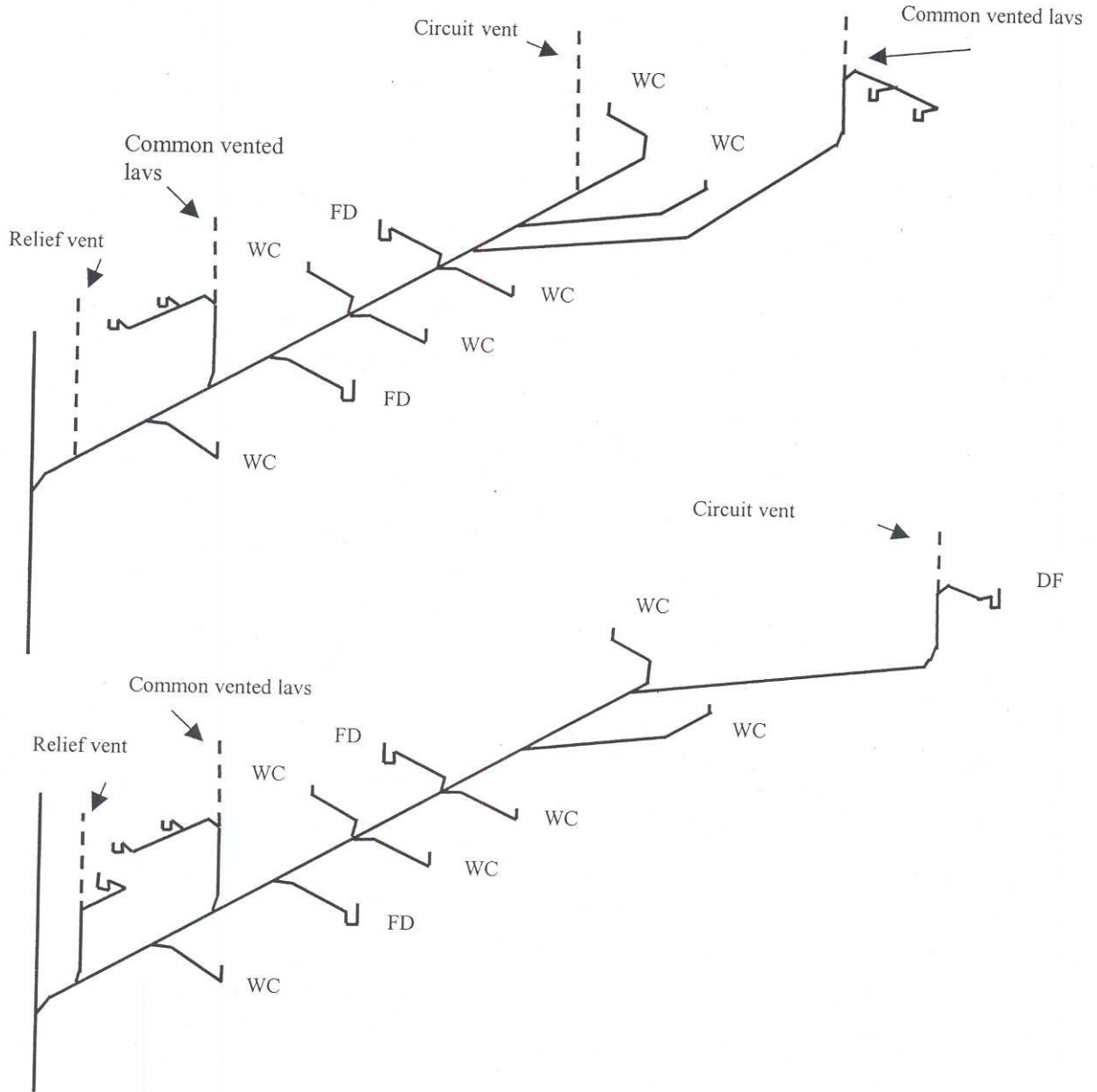

A-82.31 (1) (a) COMMON VENTS, VERTICAL, SERVING ANY TWO FIXTURES.

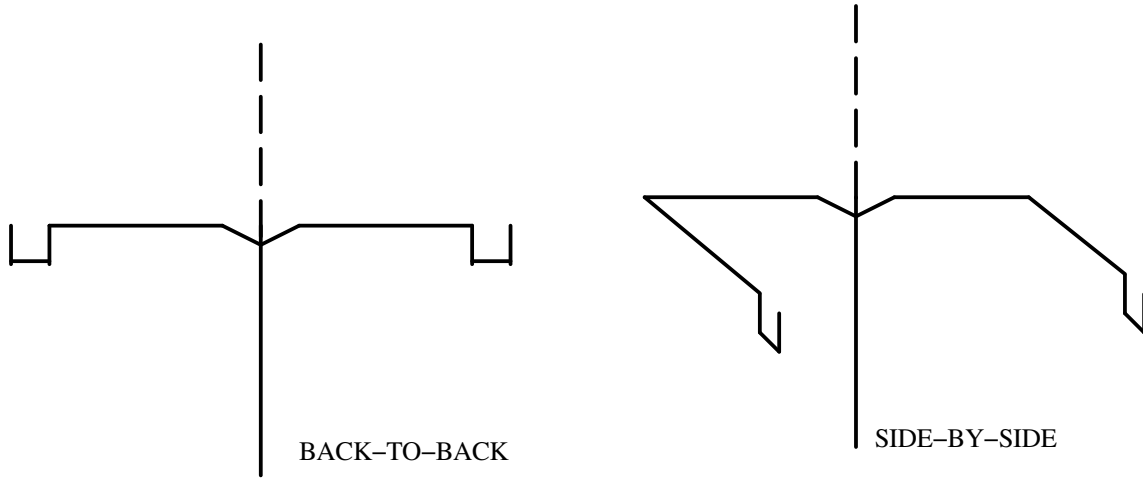

A-82.31 (1) (b) COMMON VENTS, HORIZONTAL DRAINS.

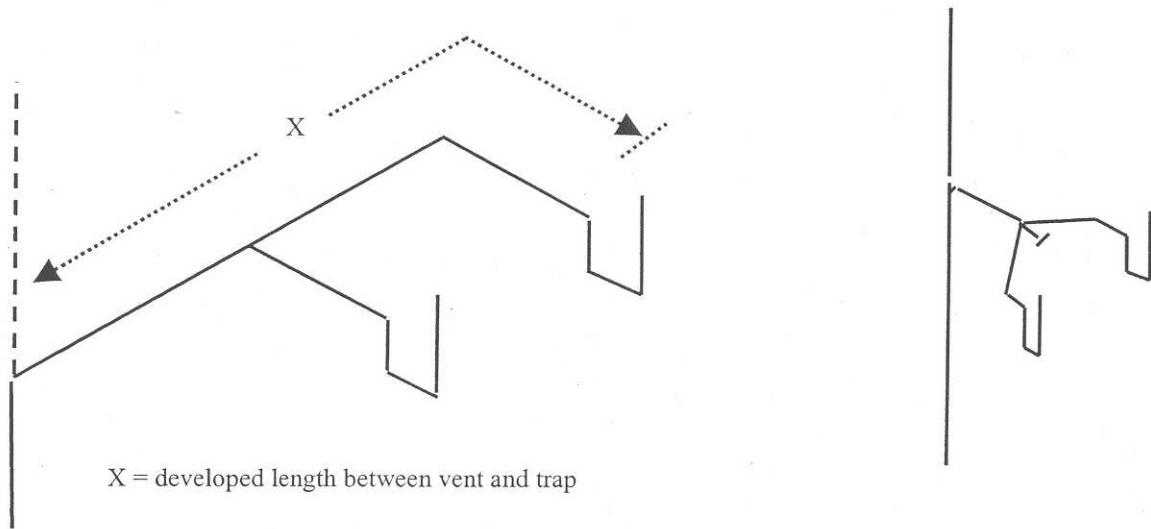

A-82.31 (12) RETURN VENTS.

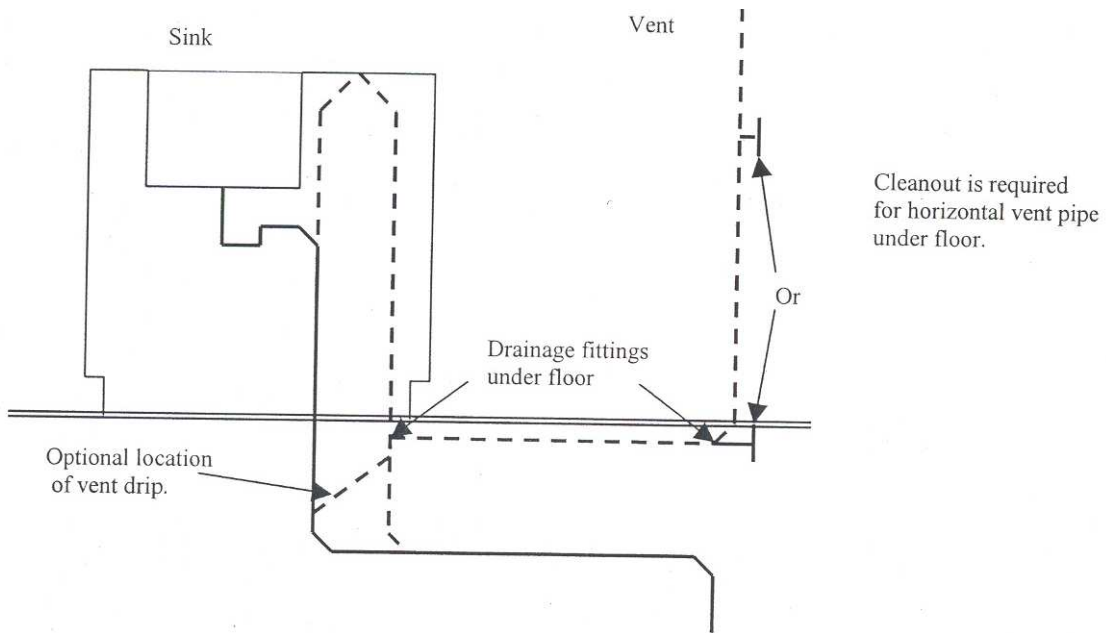

A-82.31 (13) (a) VERTICAL WET VENTS

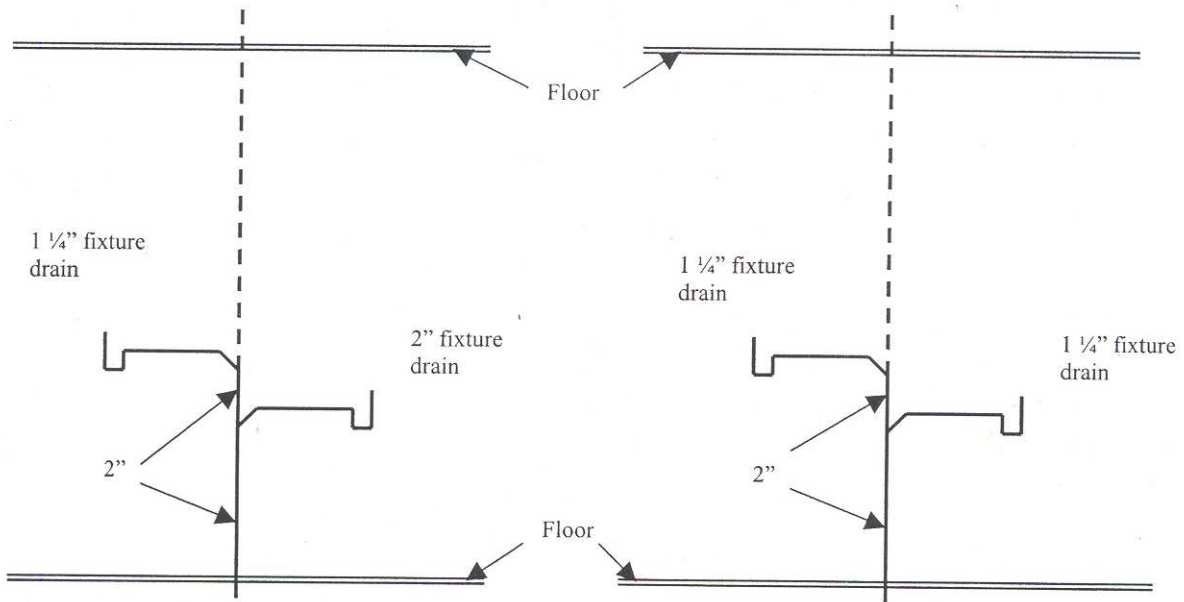

A-82.31 (13)-1. HORIZONTAL WET VENTS.

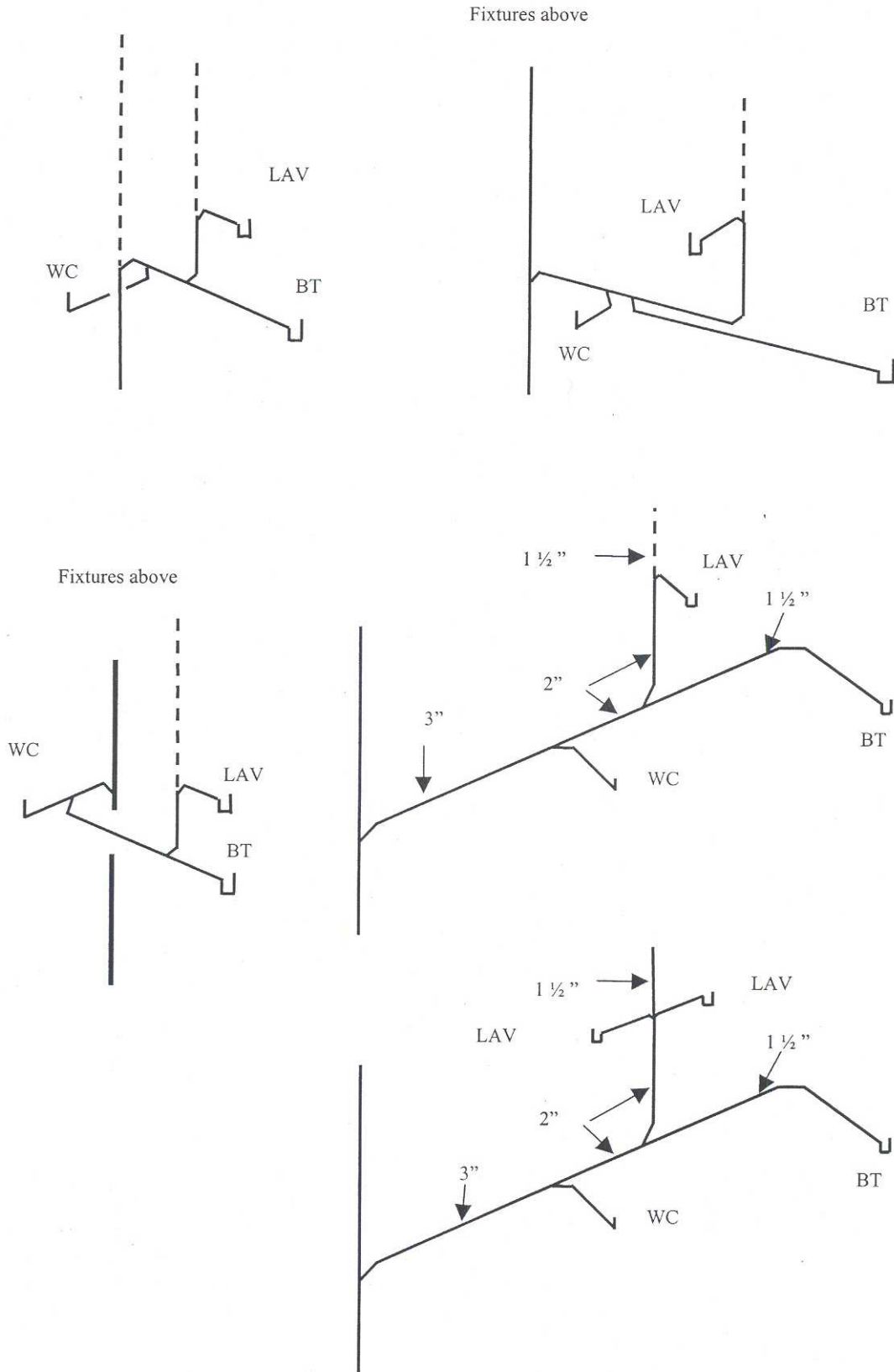

A-82.31 (13)-2. WET VENTING - FLOOR OUTLET FIXTURES.

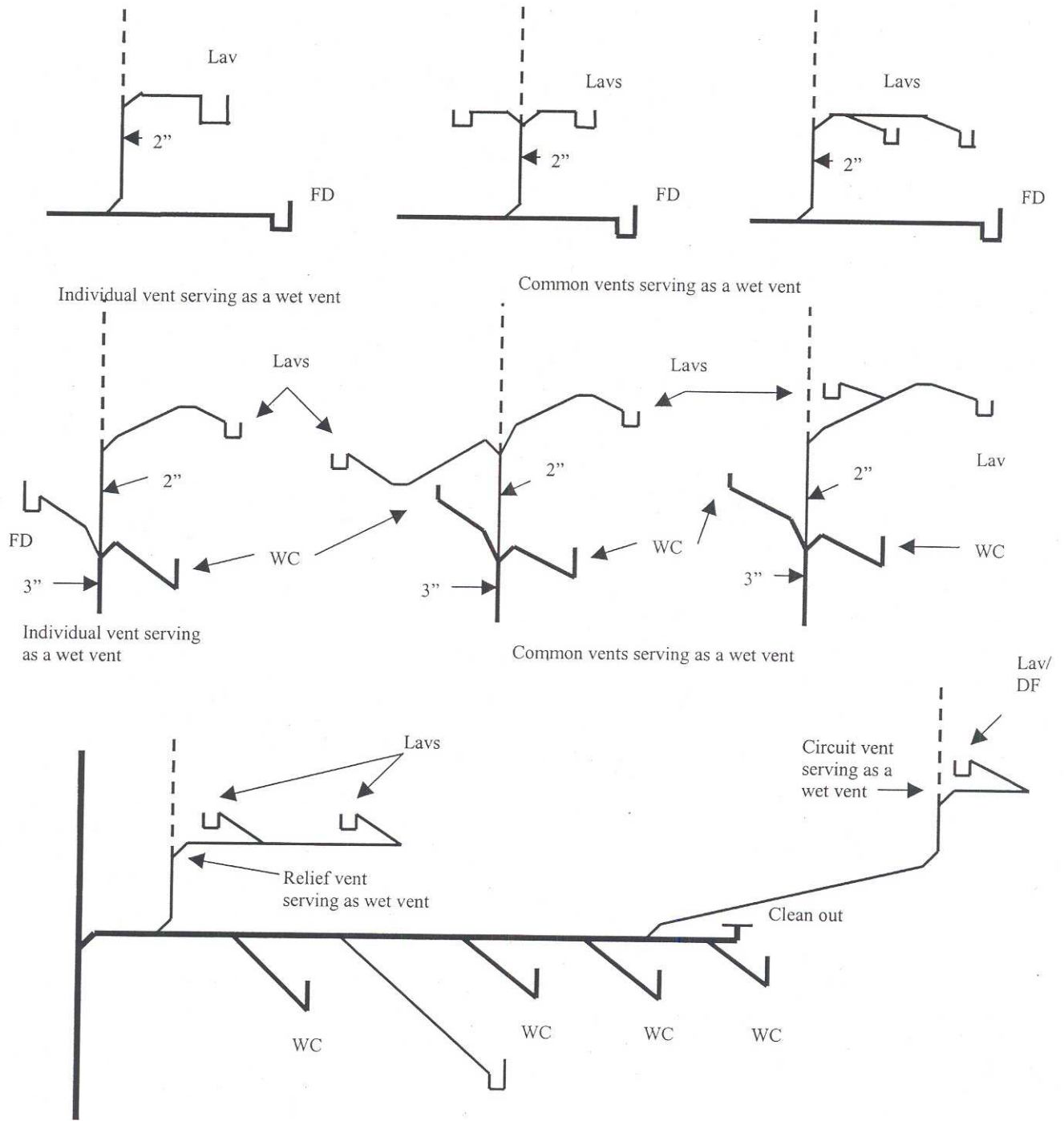

A-82.31 (14) (a) and (b) SIZING VENT STACKS AND STACK VENTS.

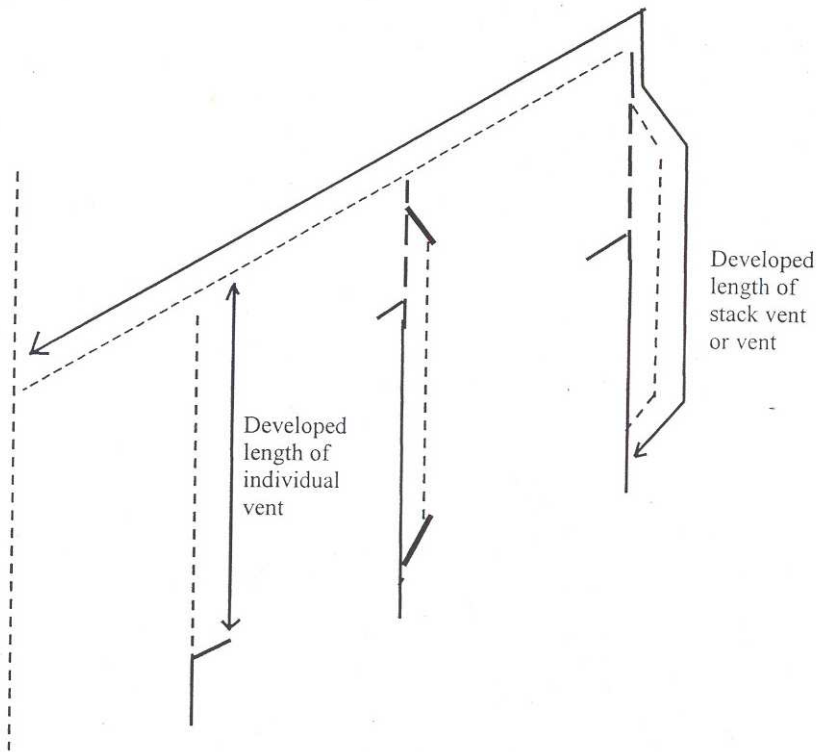

A-82.31 (14) (c) SIZING BRANCH VENTS SERVING A WET VENT.

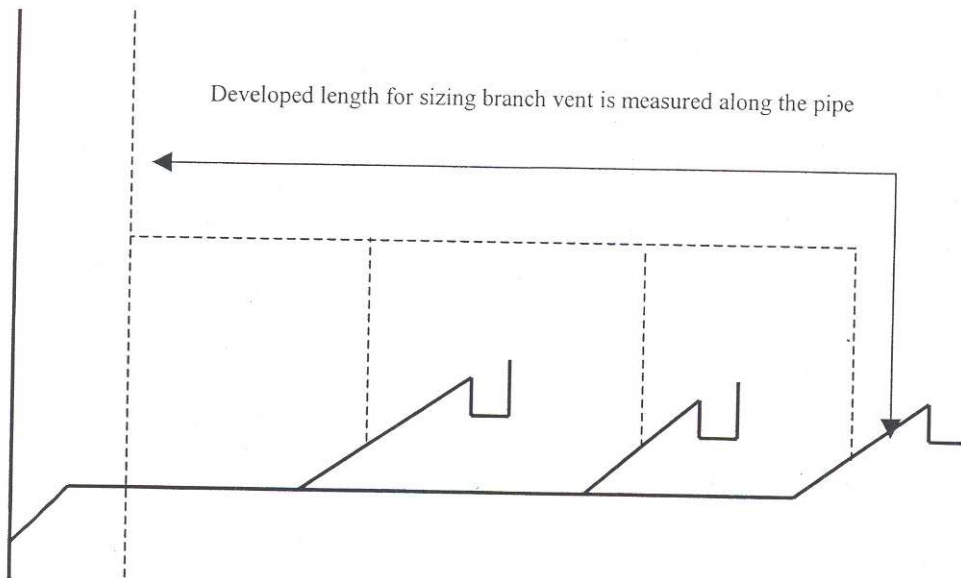

A-82.31 (14) (d) SIZING INDIVIDUAL VENTS.

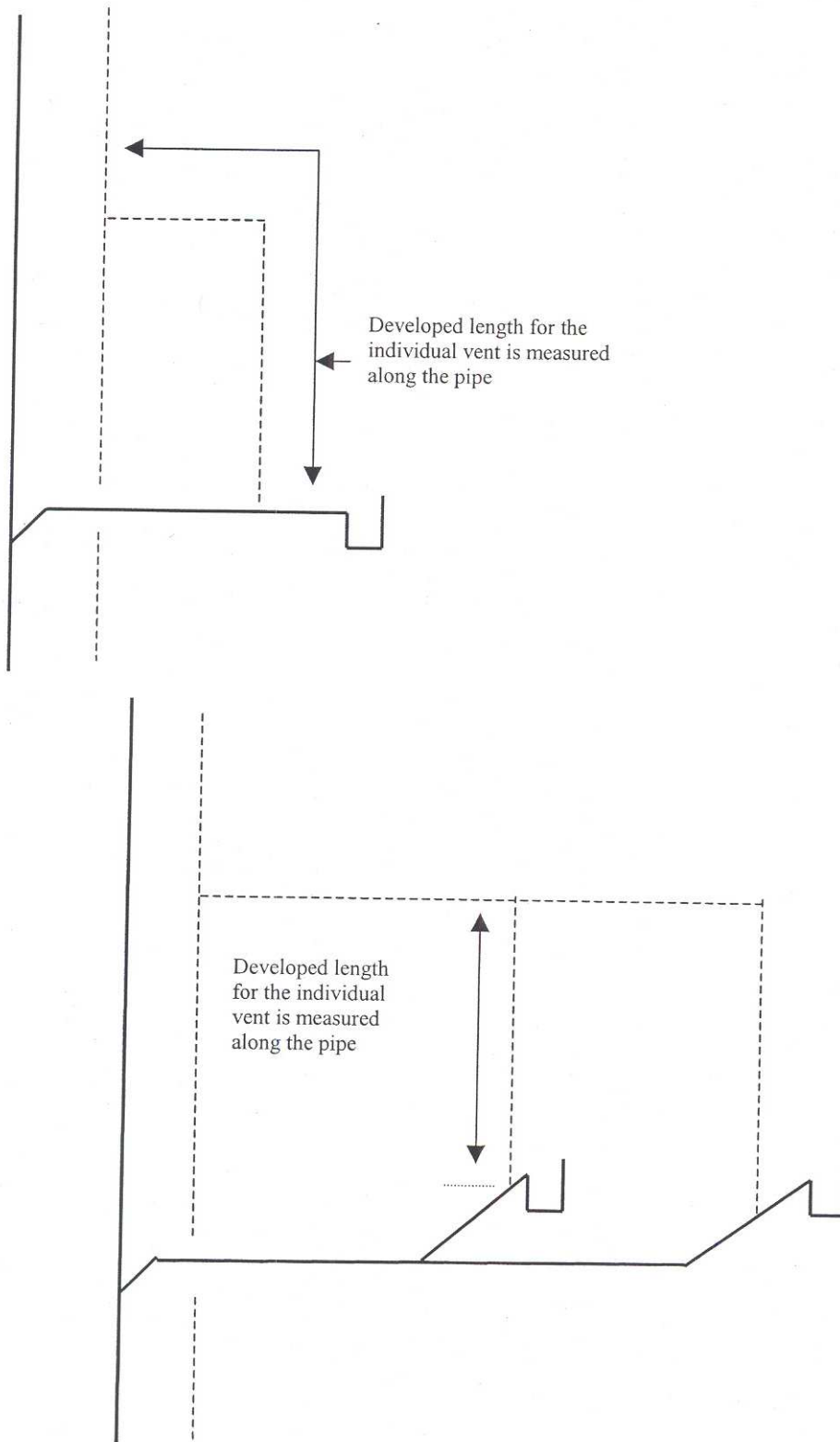

A-82.31 (15) (a) VENT GRADES AND CONNECTIONS.

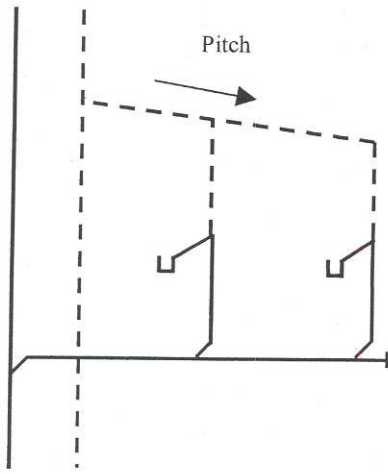

WHEREVER POSSIBLE

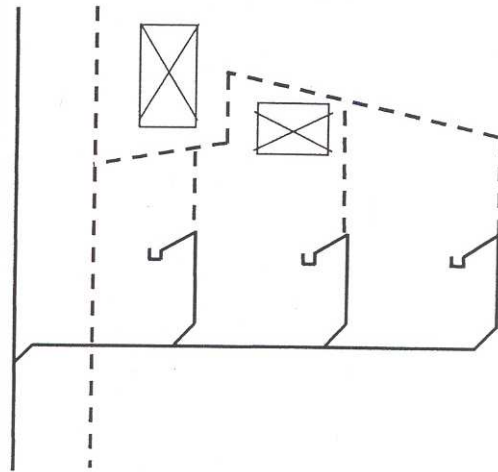

MAY BE ALLOWED WHERE CONDITIONS DICTATE

A-82.31 (15) (b) VENT GRADES AND CONNECTIONS.

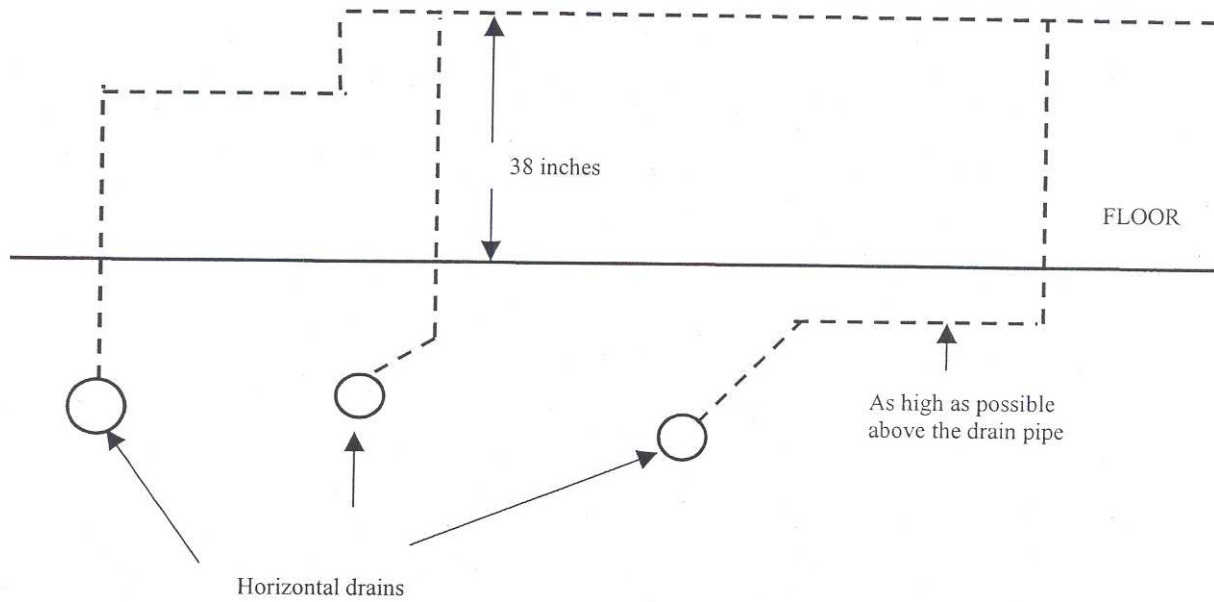

A-82.31 (16) VENT TERMINALS.

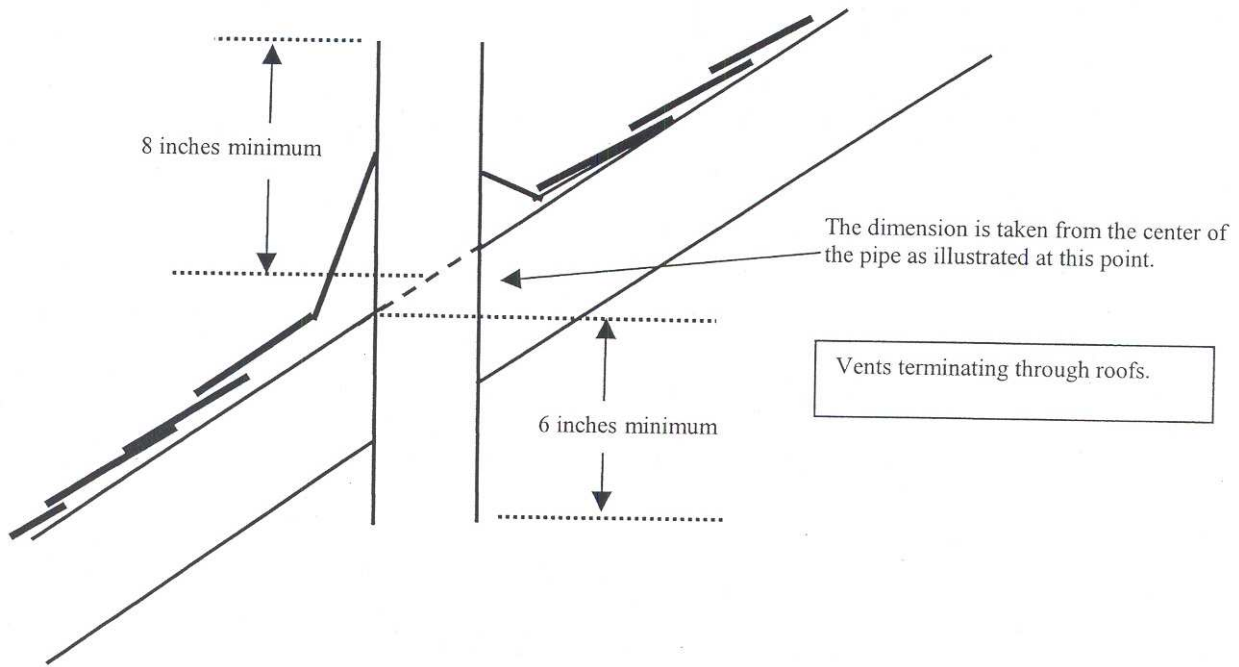

A-82.31 (16) VENT TERMINALS.

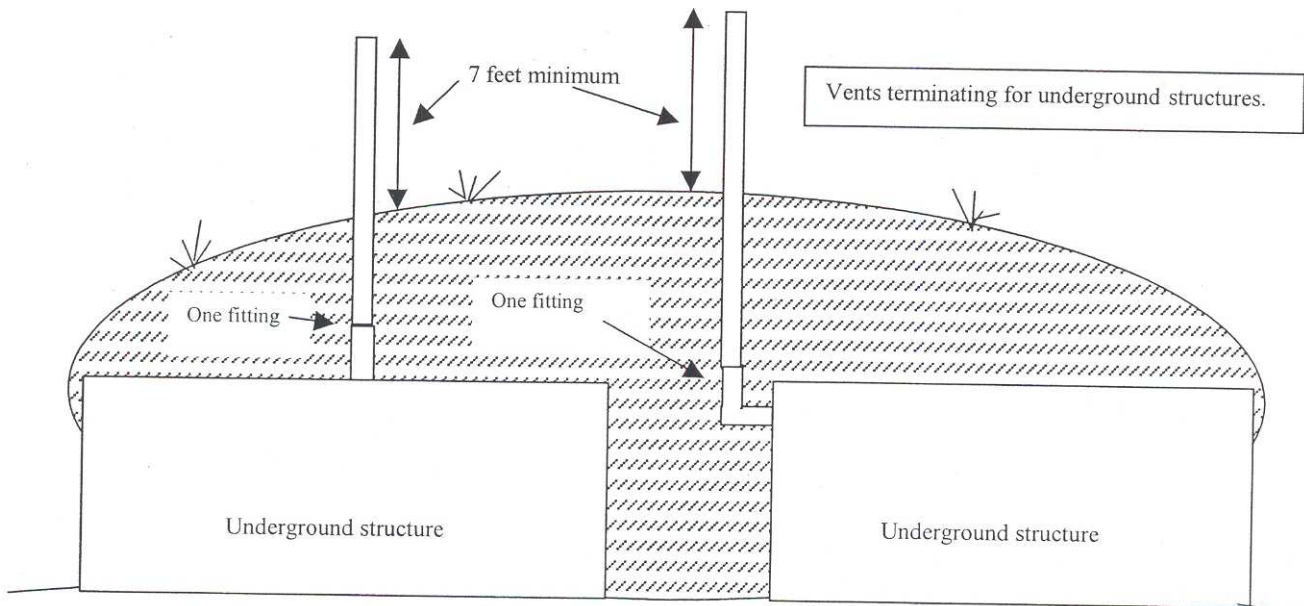
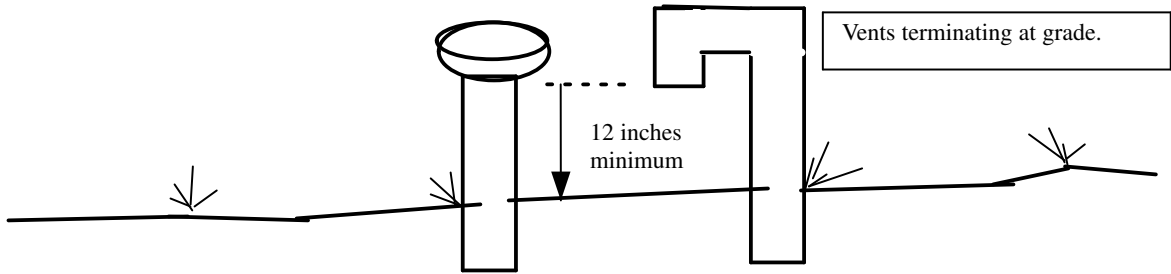

A-82.31 (17) (a) COMBINATION DRAIN AND VENT STACKS.

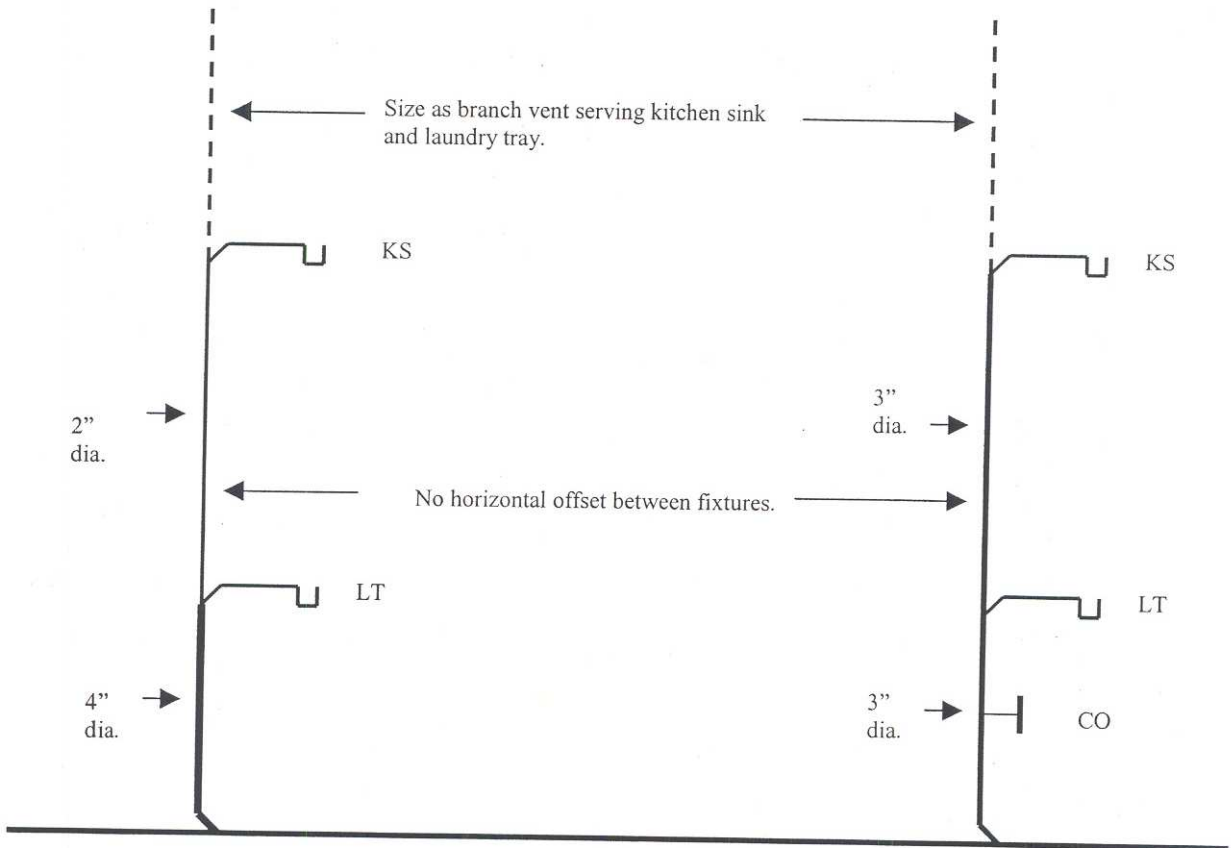
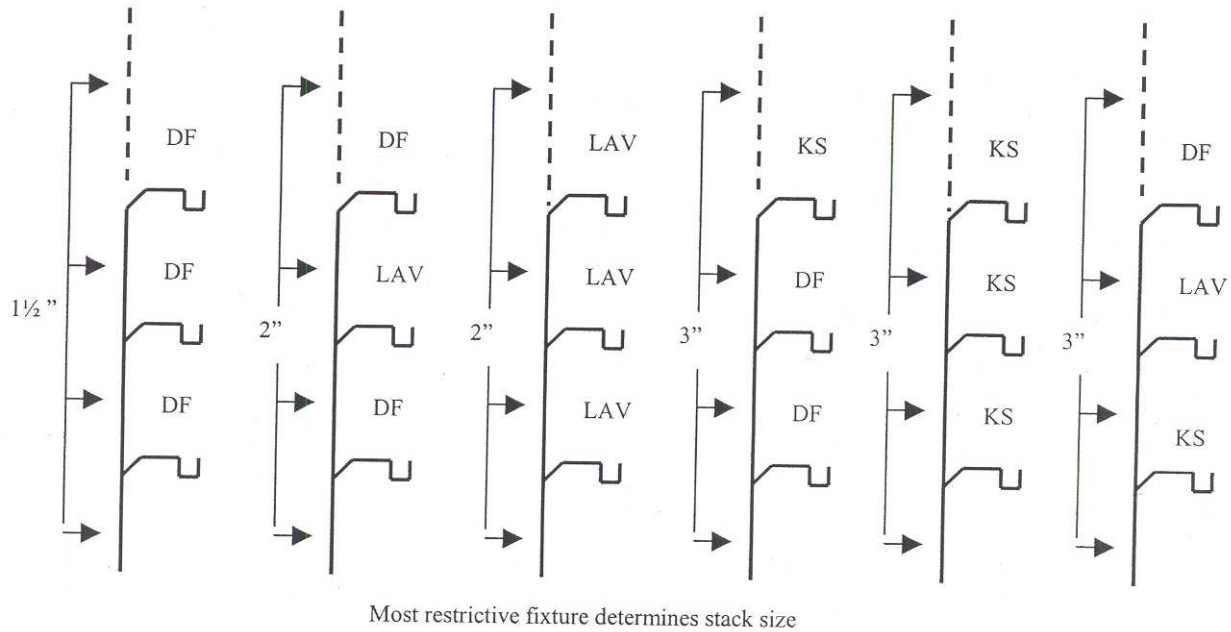

A-82.31 (17) (b) COMBINATION DRAIN AND VENT BUILDING DRAIN.

Stacks must be $\frac{1}{2}$ size of building drain, but not less than 2" diameter.

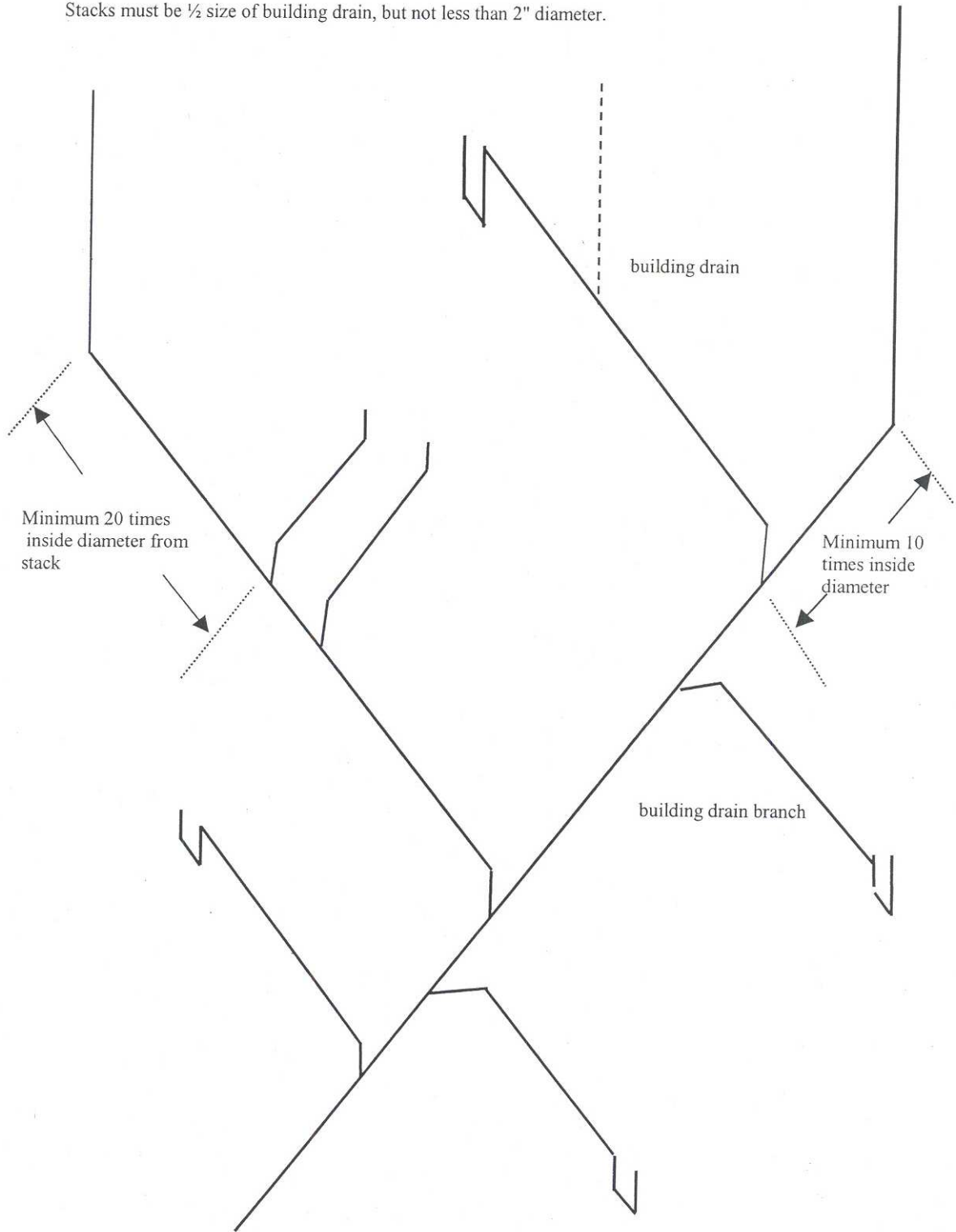

A-82.31 (17) (c) COMBINATION DRAIN AND VENT LABORATORY SINK VENTING.

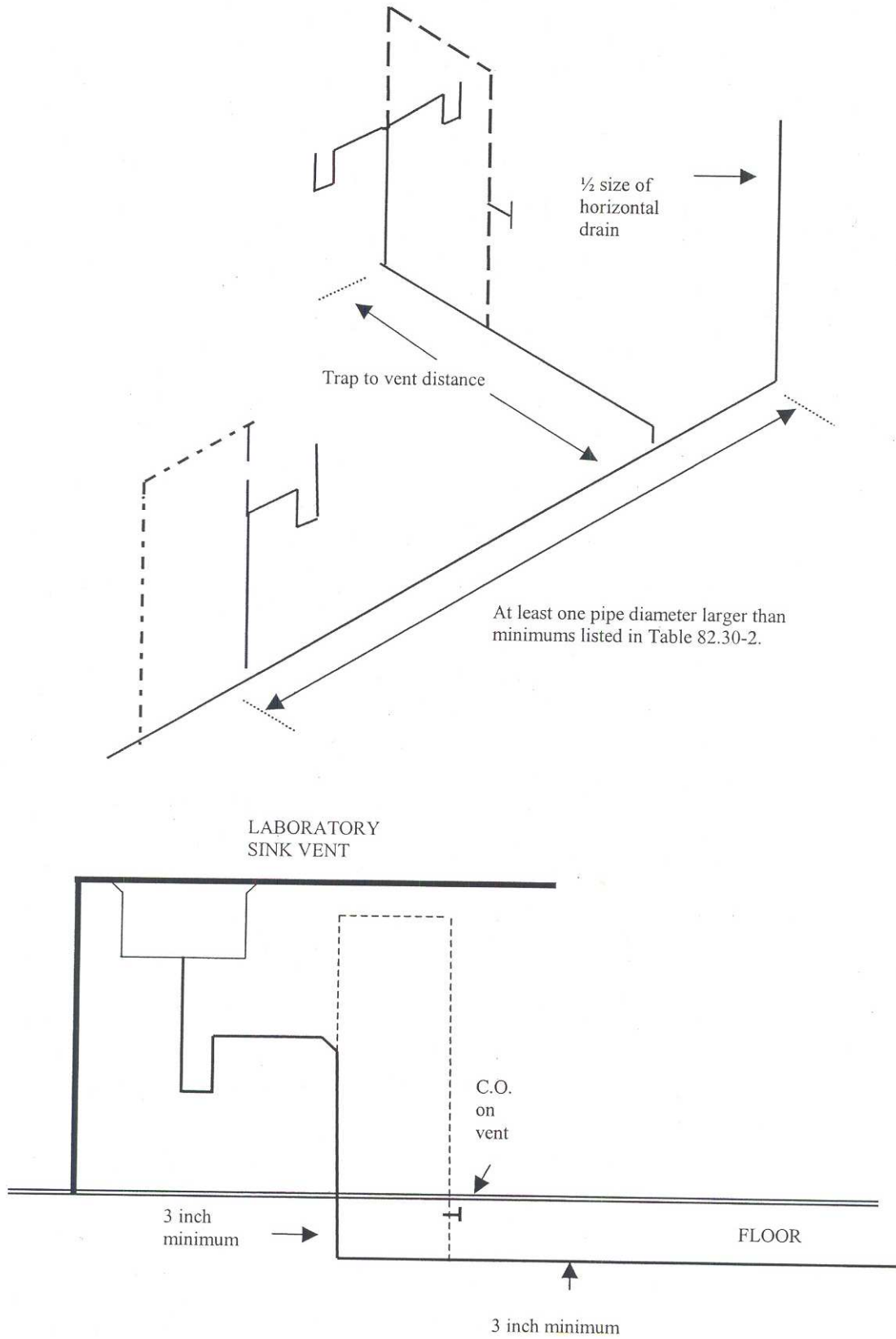

A-82.32 (4) (b) INSTALLATION OF TRAPS.

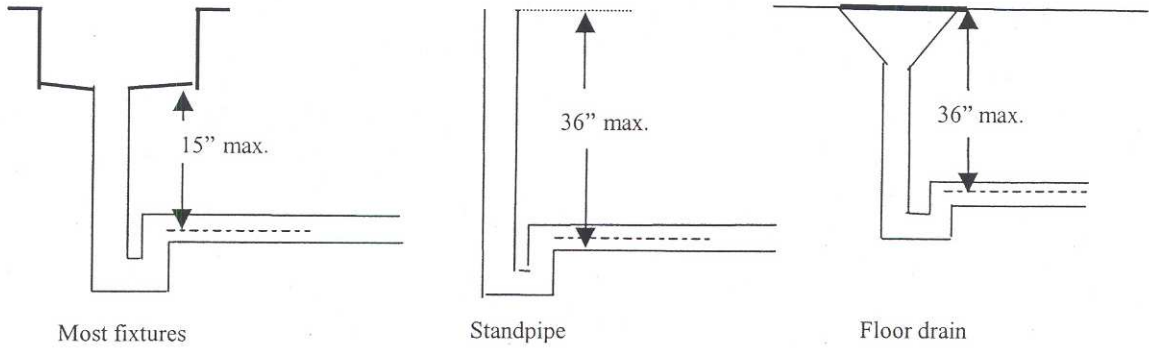

Vertical distance between fixture drain outlet and trap

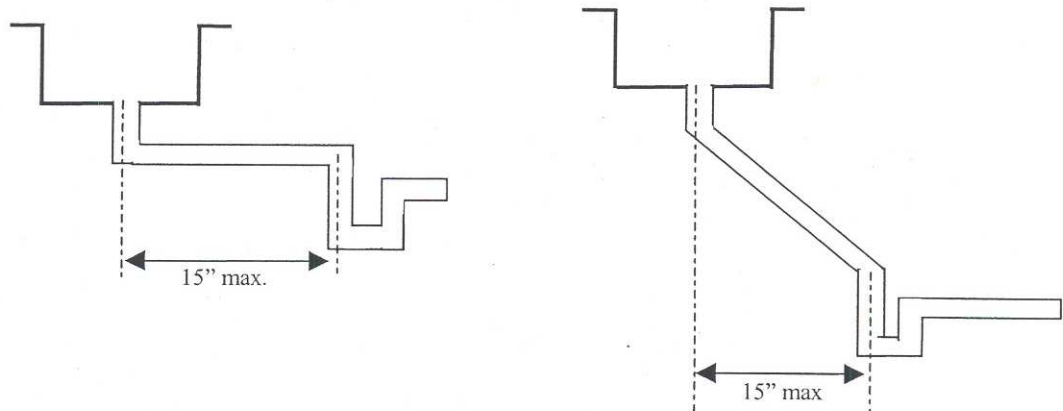
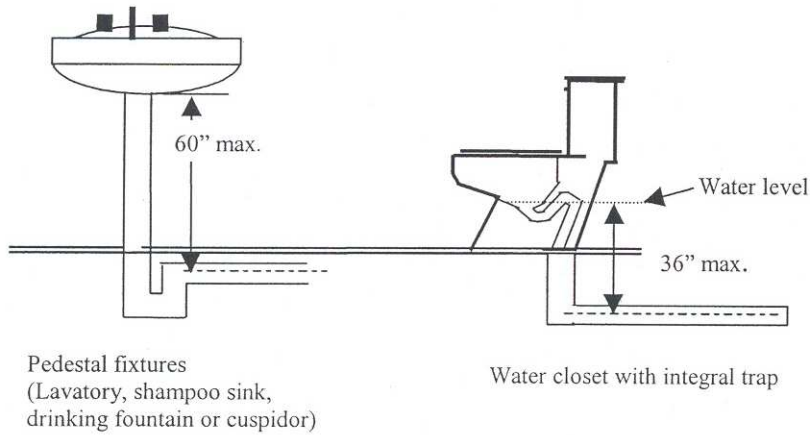

Horizontal distance between fixture drain outlet and trap

A-82.33 (6)-1. INDIRECT WASTE PIPING.

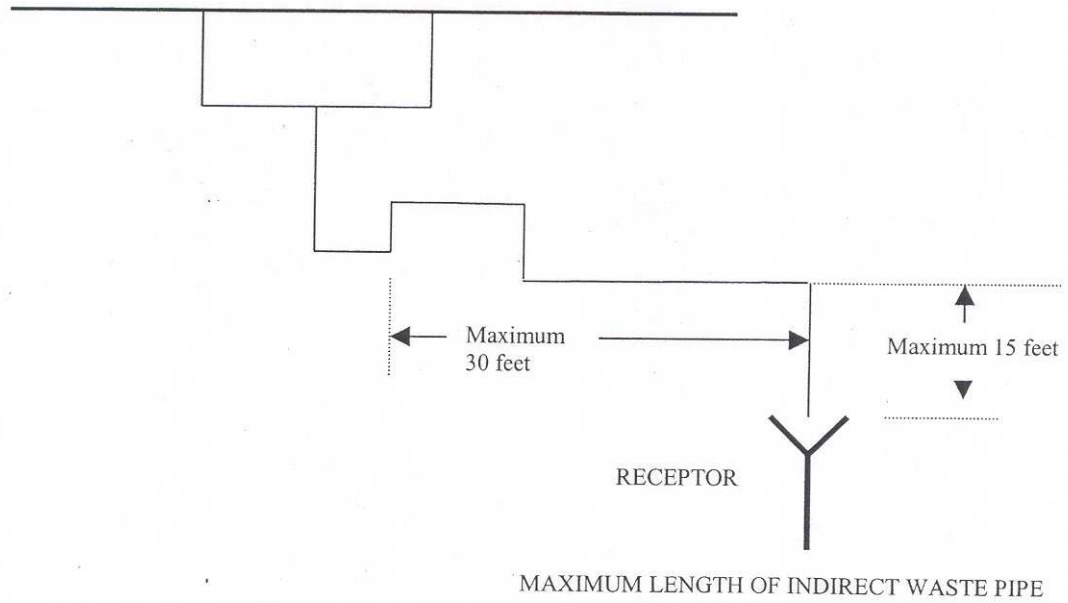

A-82.33 (6)-2. LOCAL WASTE PIPING.

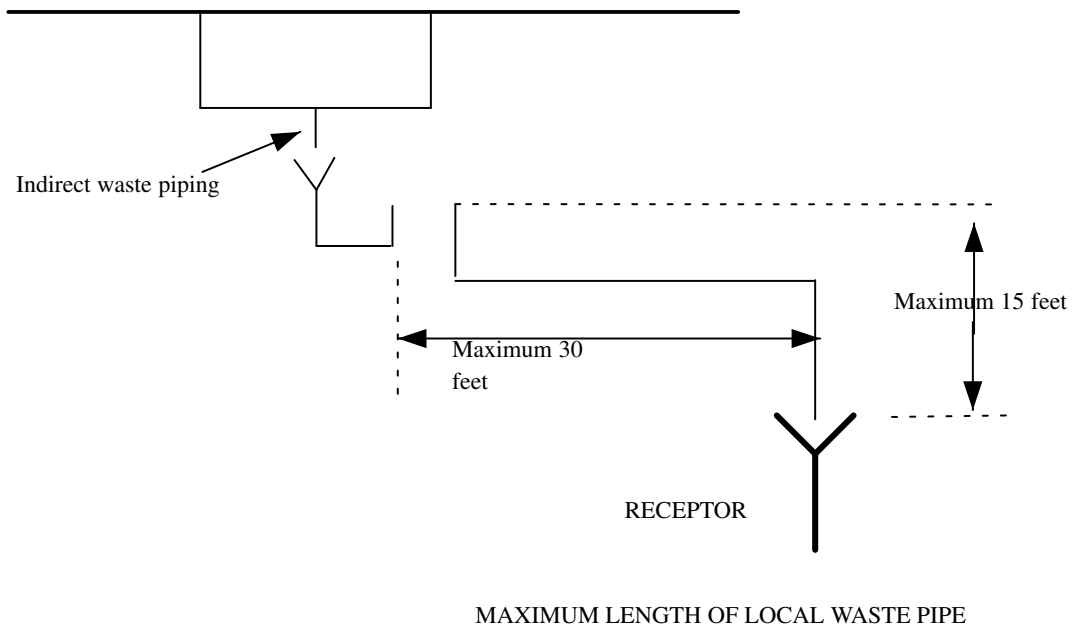

A-82.33 (7) AIR-GAPS AND AIR-BREAKS.

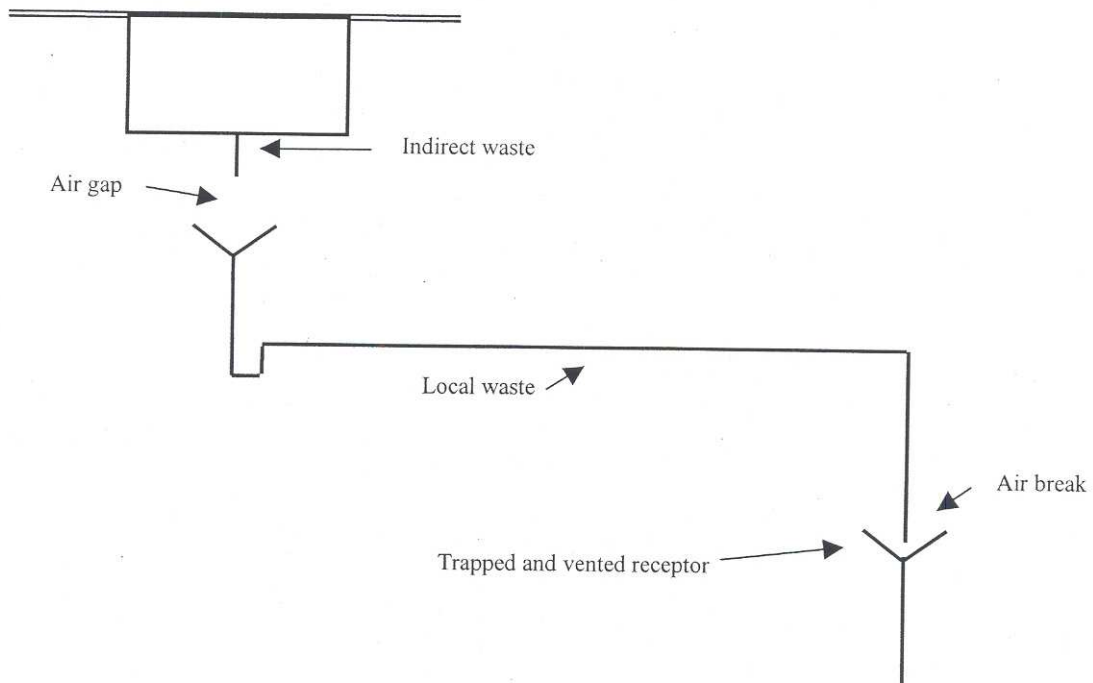
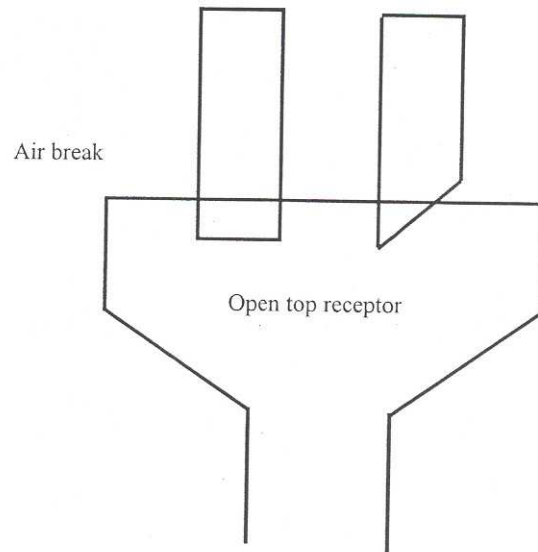
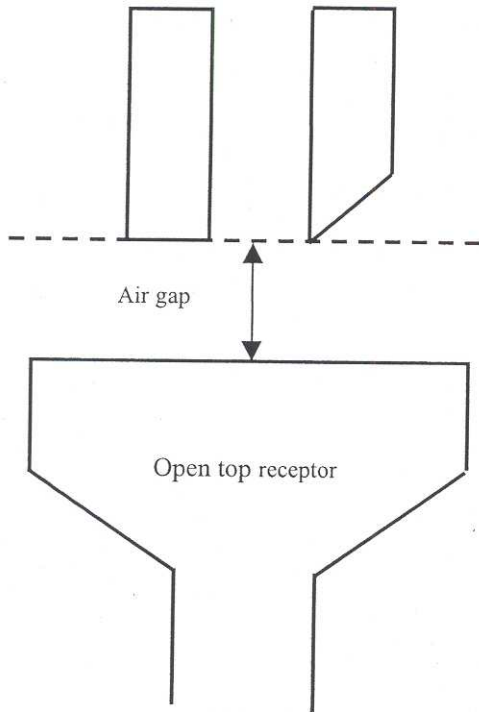

A-82.33 (8) (a) WASTE SINKS AND STANDPIPES.

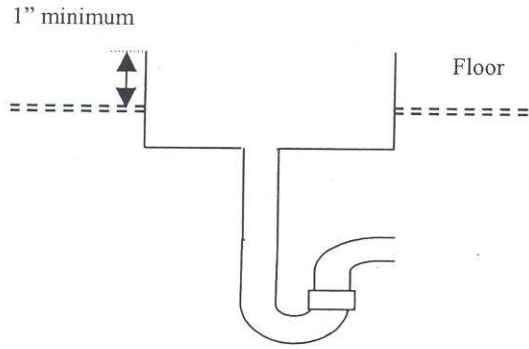

WASTE SINK IN FLOOR

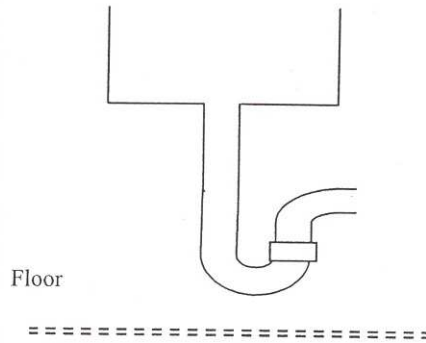

WASTE SINK ABOVE FLOOR

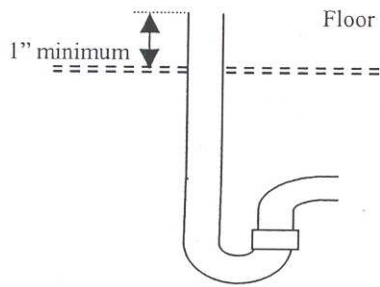

STANDPIPE IN FLOOR

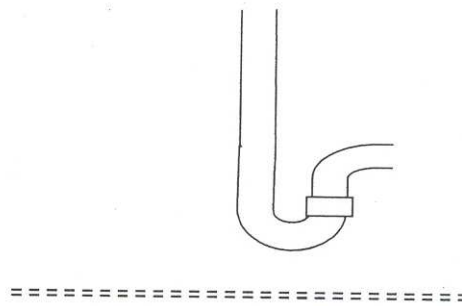

STANDPIPE ABOVE FLOOR

A-82.33 (8) (b) FLOOR SINKS.

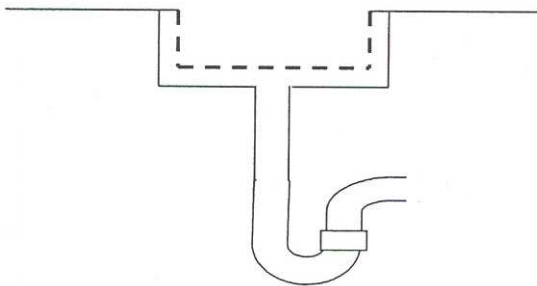

FLOOR SINK WITH BASKET

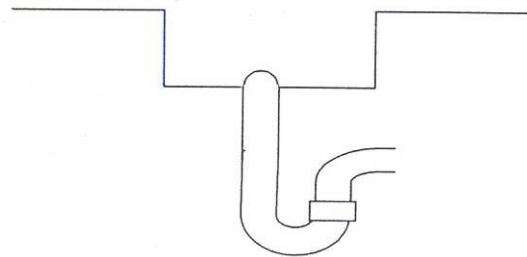

FLOOR SINK WITH DOME STRAINER

A-82.33 (8) (b) FLOOR SINK WITH GRATE OPENING.

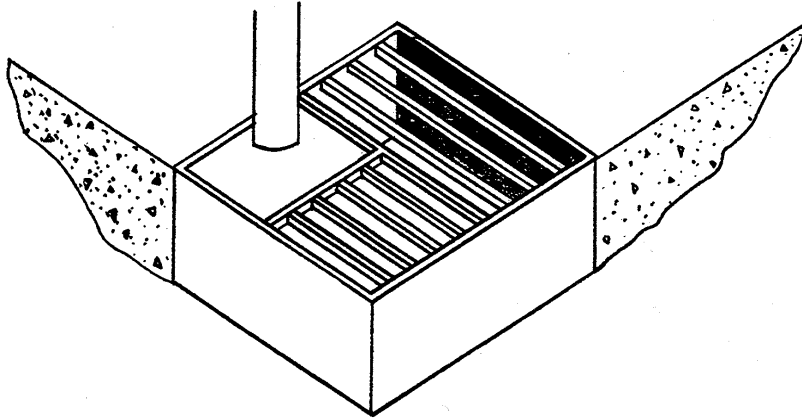

A-82.33 (8) (c)-1. LOCAL WASTE PIPING.

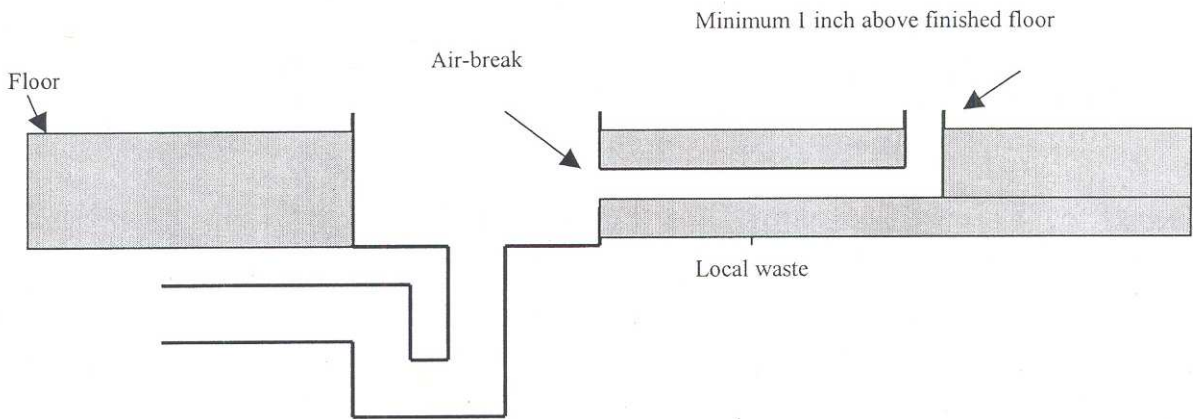

LOCAL WASTE LEADING TO A WASTE SINK, FLOOR SINK OR FLOOR DRAIN

A-82.33 (8) (c)-2. LOCAL WASTE PIPING.

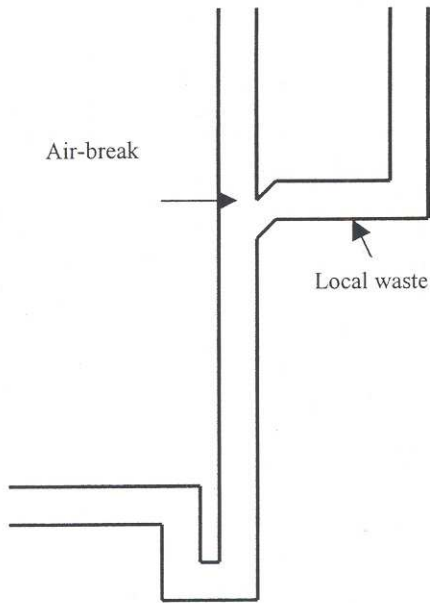

LOCAL WASTE DISCHARGING TO STANDPIPE

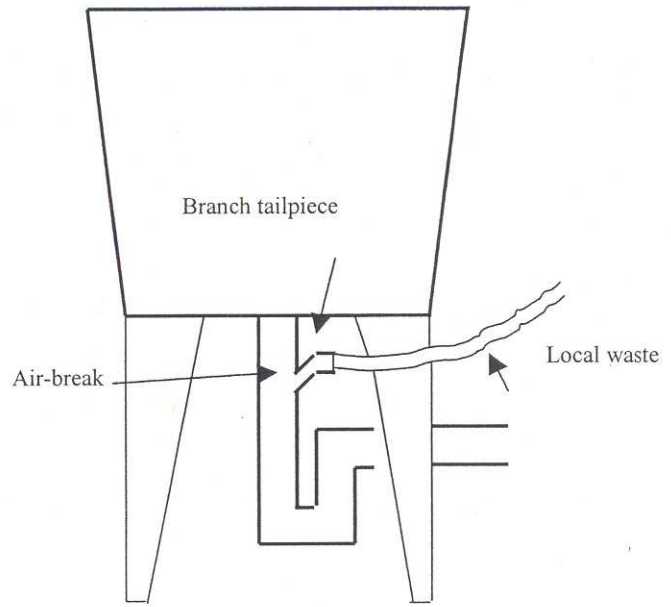

LOCAL WASTE DISCHARGING TO BRANCH TAILPIECE

A-82.33 (8) (d)-1. LOCAL WASTE PIPING SERVING WATER HEATER TEMPERATURE AND PRESSURE RELIEF VALVES.

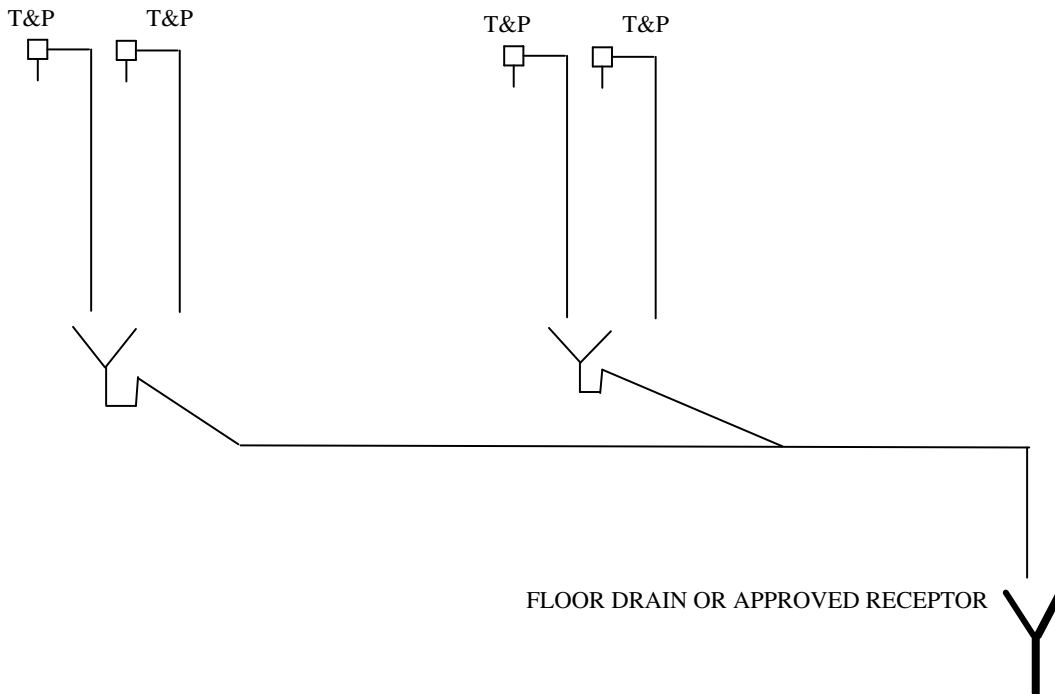

A-82.33 (8) (d)-2. LOCAL WASTE PIPING SERVING WATER HEATER TEMPERATURE AND PRESSURE RELIEF VALVES.

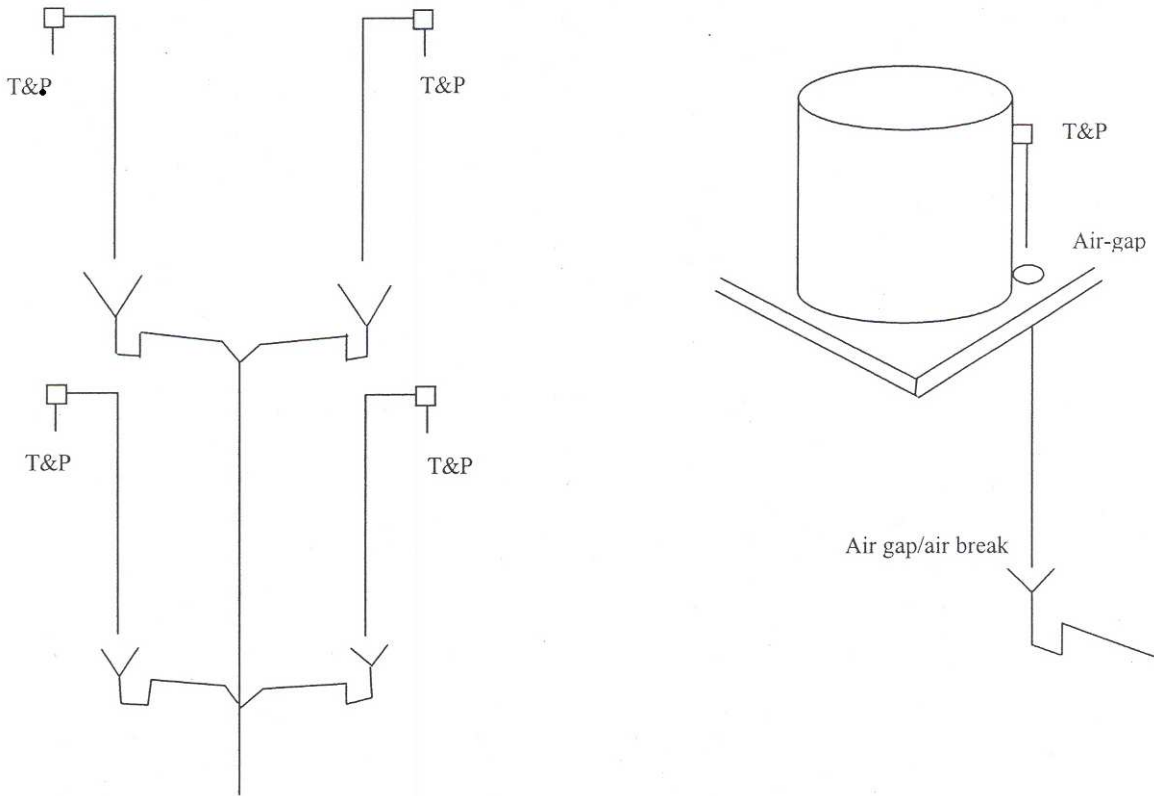

A-82.33 (9) (c) COMMERCIAL GRAVITY DISCHARGE-TYPE CLOTHES WASHERS.

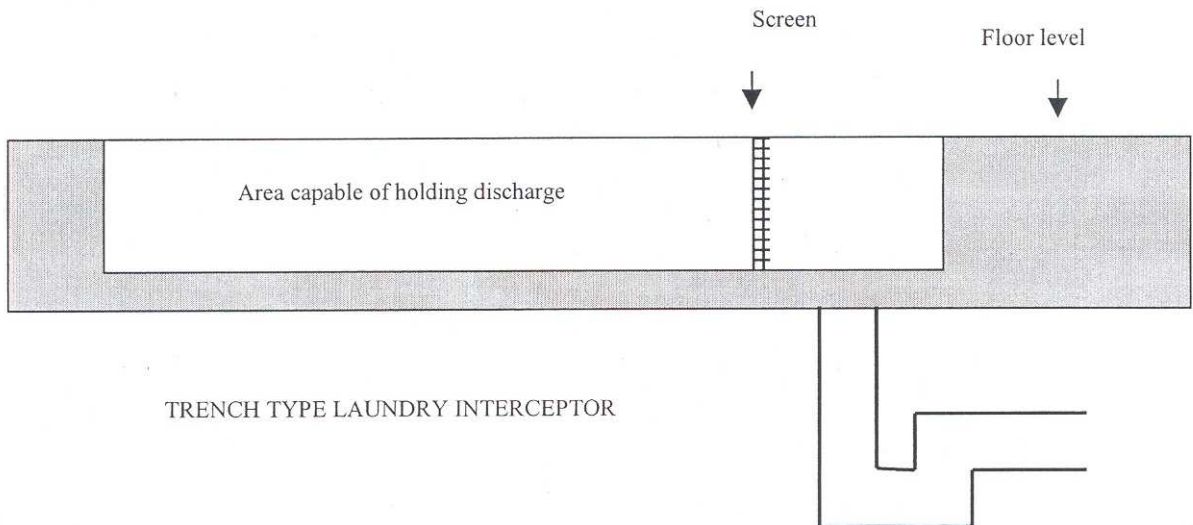

A-82.33 (9) (d)-1. RESIDENTIAL-TYPE CLOTHES WASHERS.

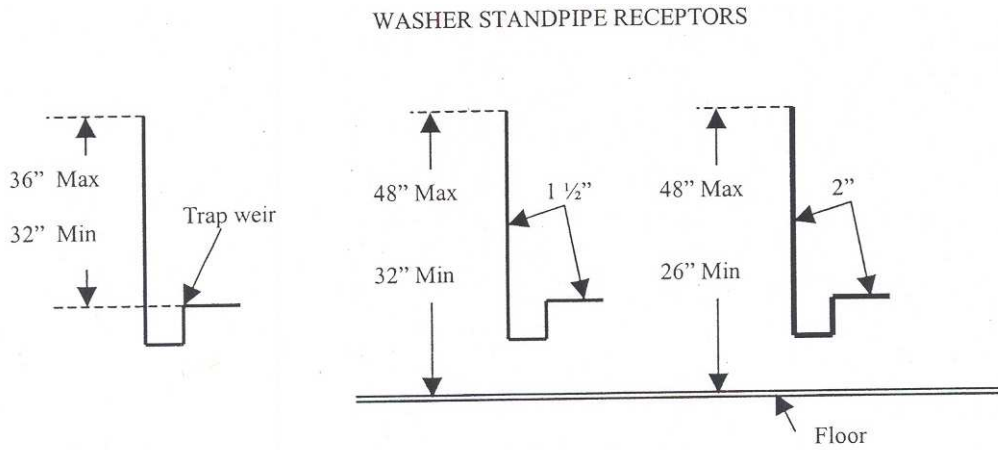

A-82.33 (9) (d)-2. RESIDENTIAL-TYPE DISHWASHERS.

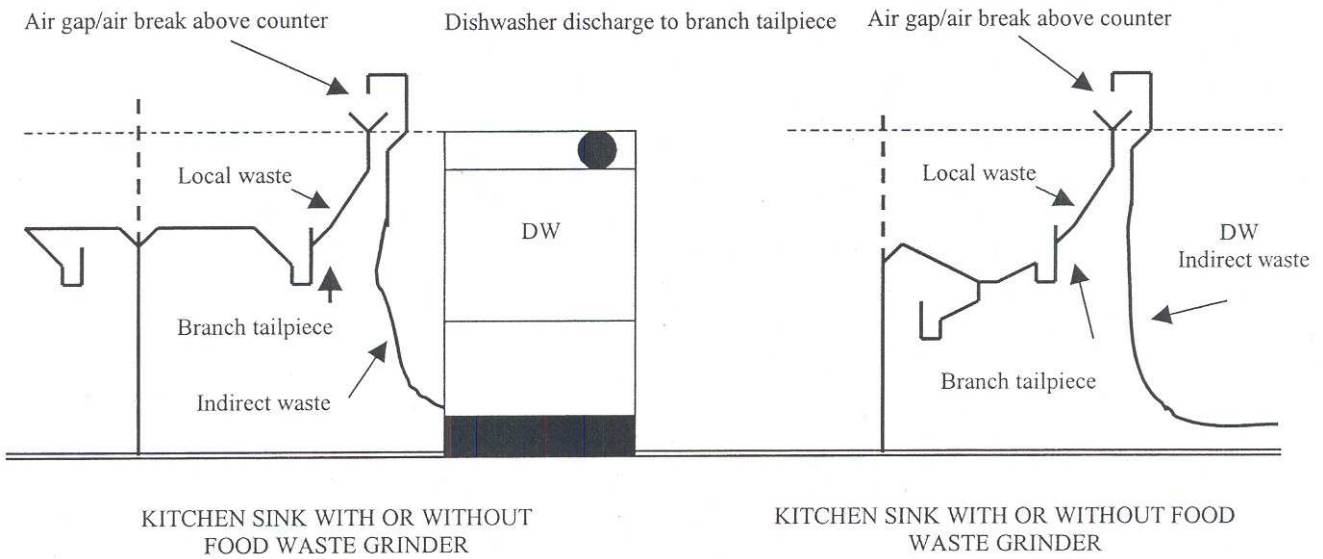

A-82.33 (9) (d)-3. RESIDENTIAL-TYPE DISHWASHERS.

Dishwasher discharge to branch tailpiece

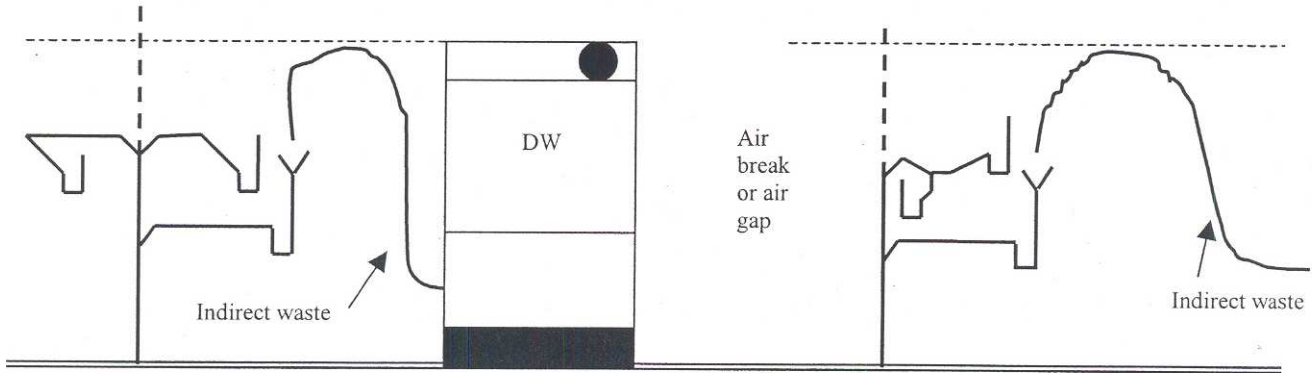

KITCHEN SINK WITH OR WITHOUT
FOOD WASTE GRINDER

A-82.33 (9) (d)-4. COMMERCIAL DISHWASHERS.

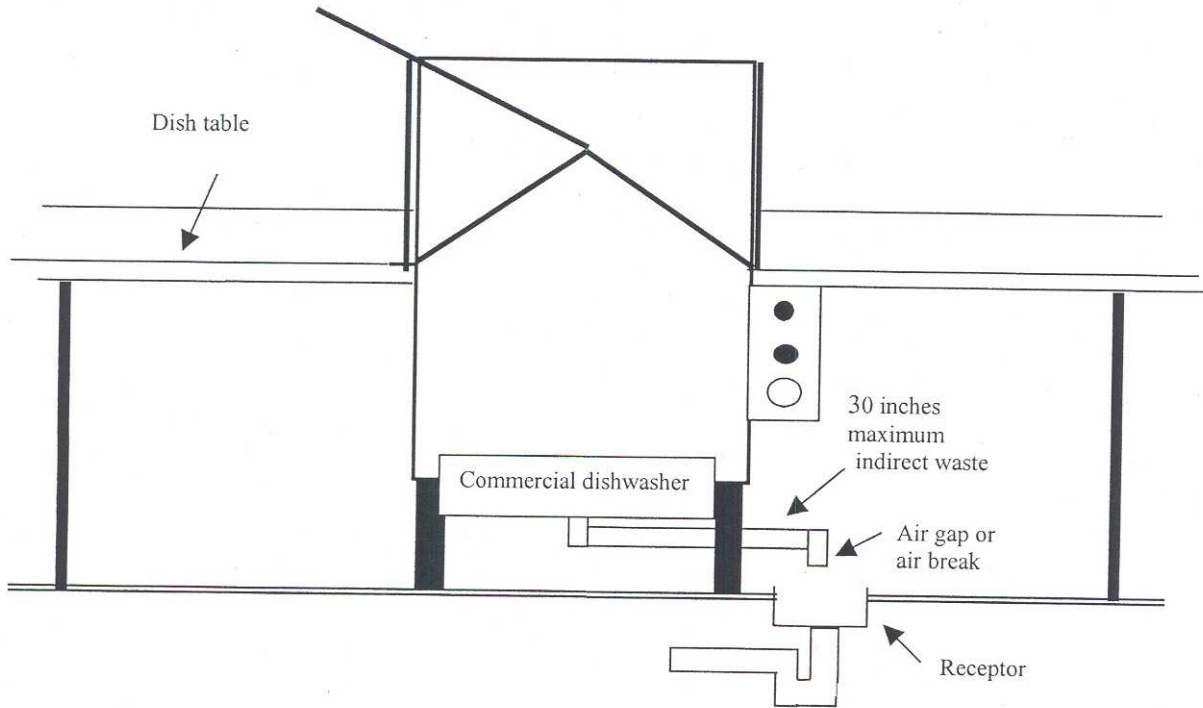

A-82.33 (9) (f)-1. ELEVATOR PIT SUBSOIL AND FLOOR DRAINS. Drains and sumps complying with ss. Comm 82.33 and 82.36 shall be provided.

Note: Section Comm 18.23 includes requirements for the installation of drains and sumps. Section Comm 18.23 reads: "Drains and sumps complying with ss. Comm 82.33 and 82.36 shall be provided. Drains connected directly to sanitary drain systems shall not be installed in elevator pits."

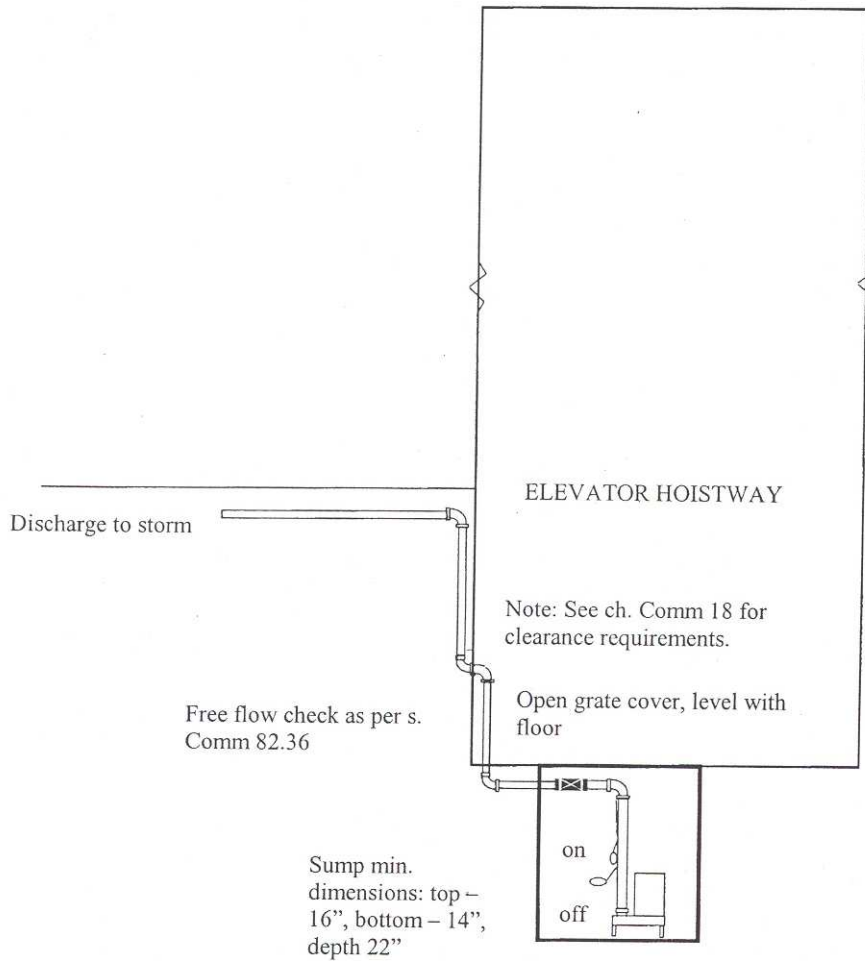

A-82.33 (9) (f)-2. ELEVATOR PIT SUBSOIL AND FLOOR DRAINS.

ELEVATOR DRAIN DISCHARGE - STORM DRAIN CONNECTION

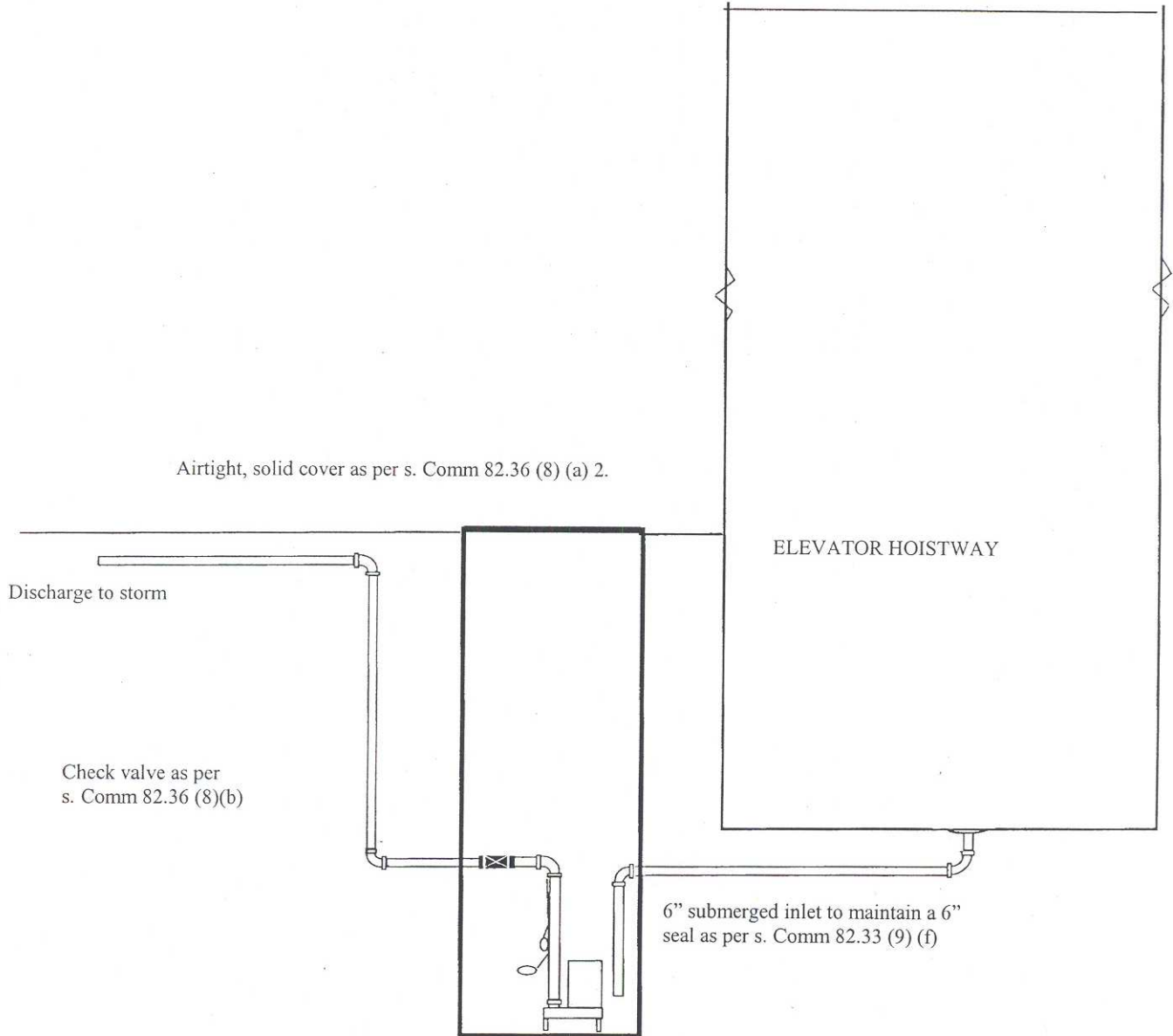

A-82.33 (9) (g) 1. BAR AND SODA FOUNTAIN SINKS.

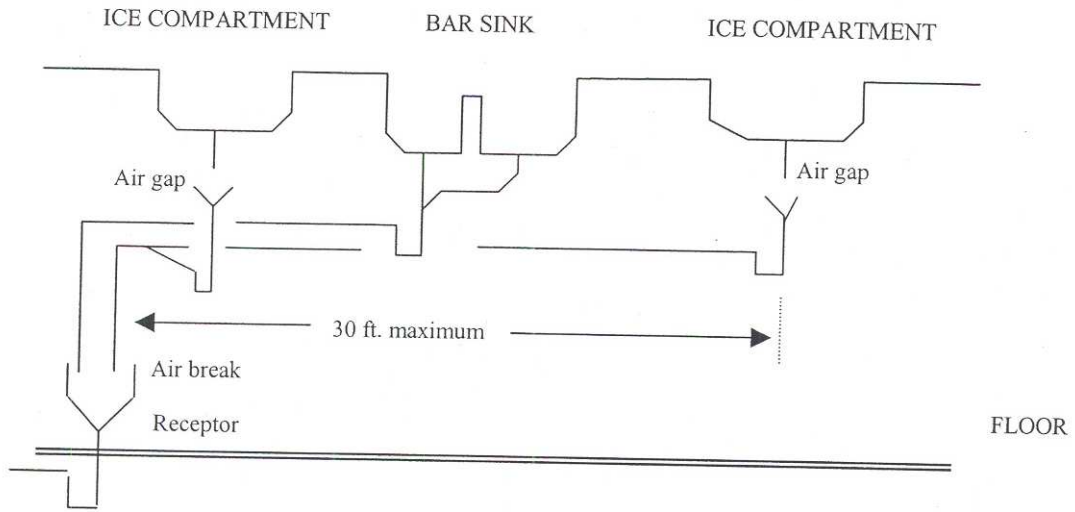

A-82.33 (9) (g) 2. BEER TAPS, COFFEE MAKERS, GLASS FILLERS AND SODA DISPENSERS.

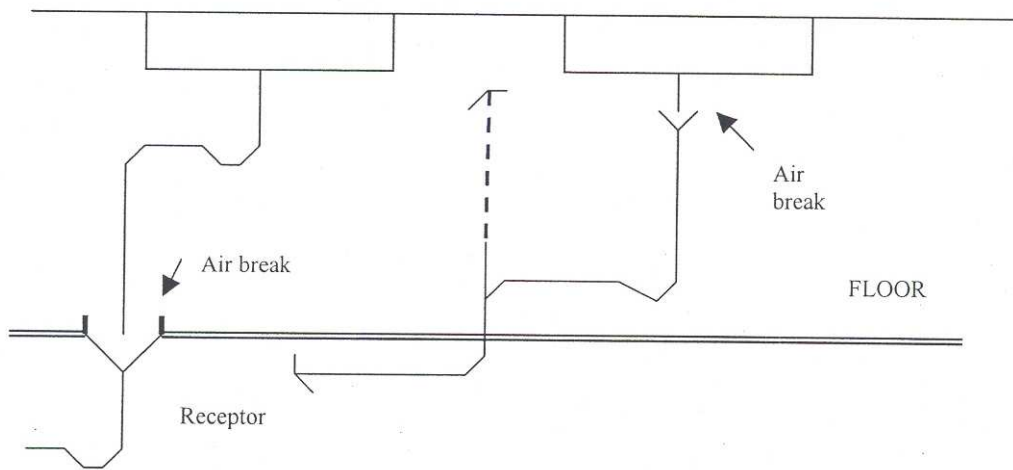

A-82.33 (9) (g) 3. NOVELTY BOXES AND ICE COMPARTMENTS AND ICE CREAM DIPPER WELLS.

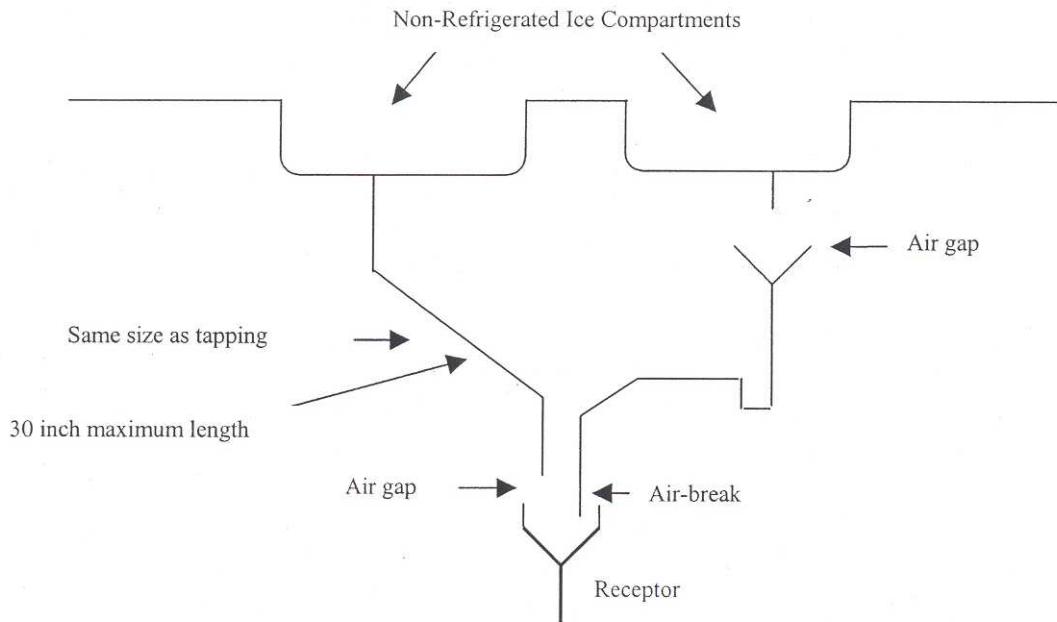
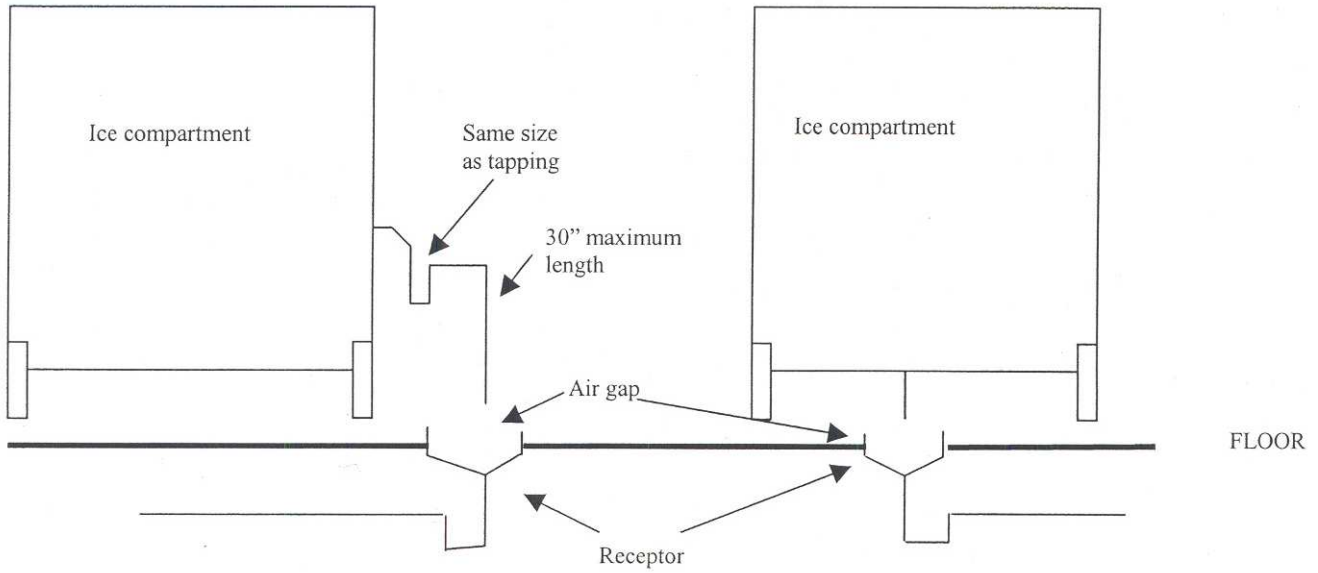

A-82.33 (9) (g) 4. REFRIGERATED FOOD STORAGE ROOMS, COMPARTMENTS AND DISPLAY CASES.

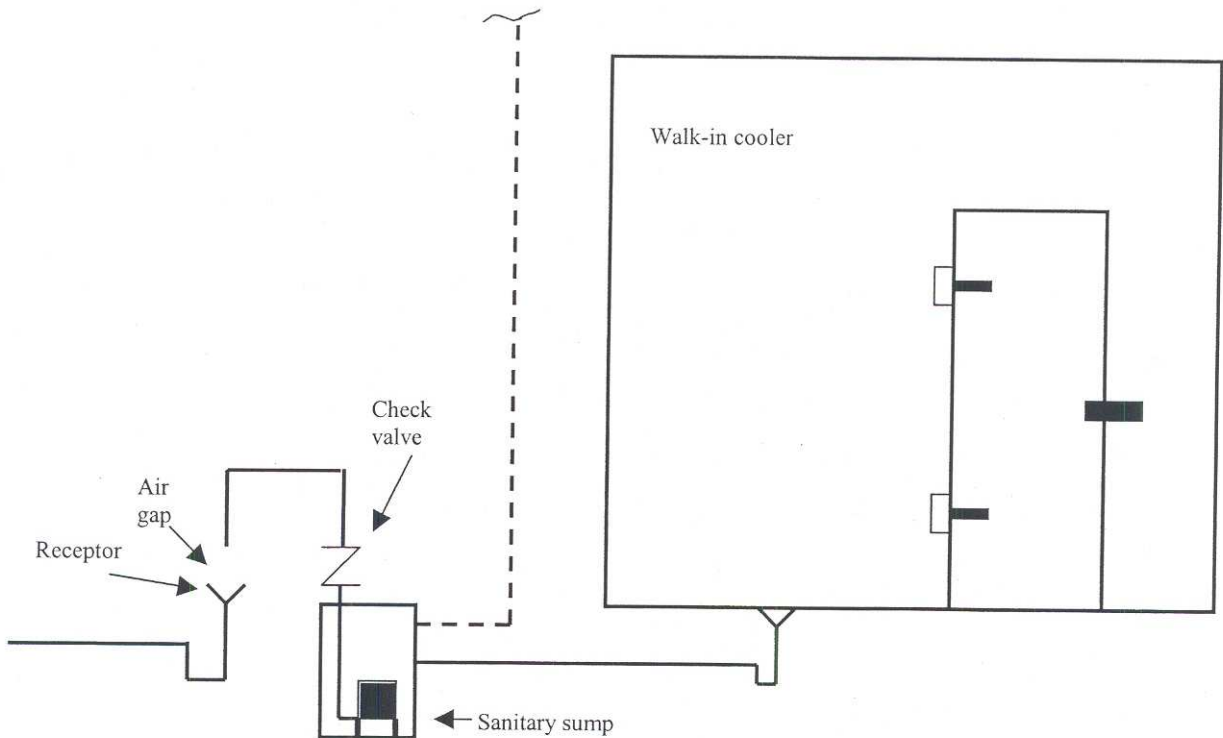
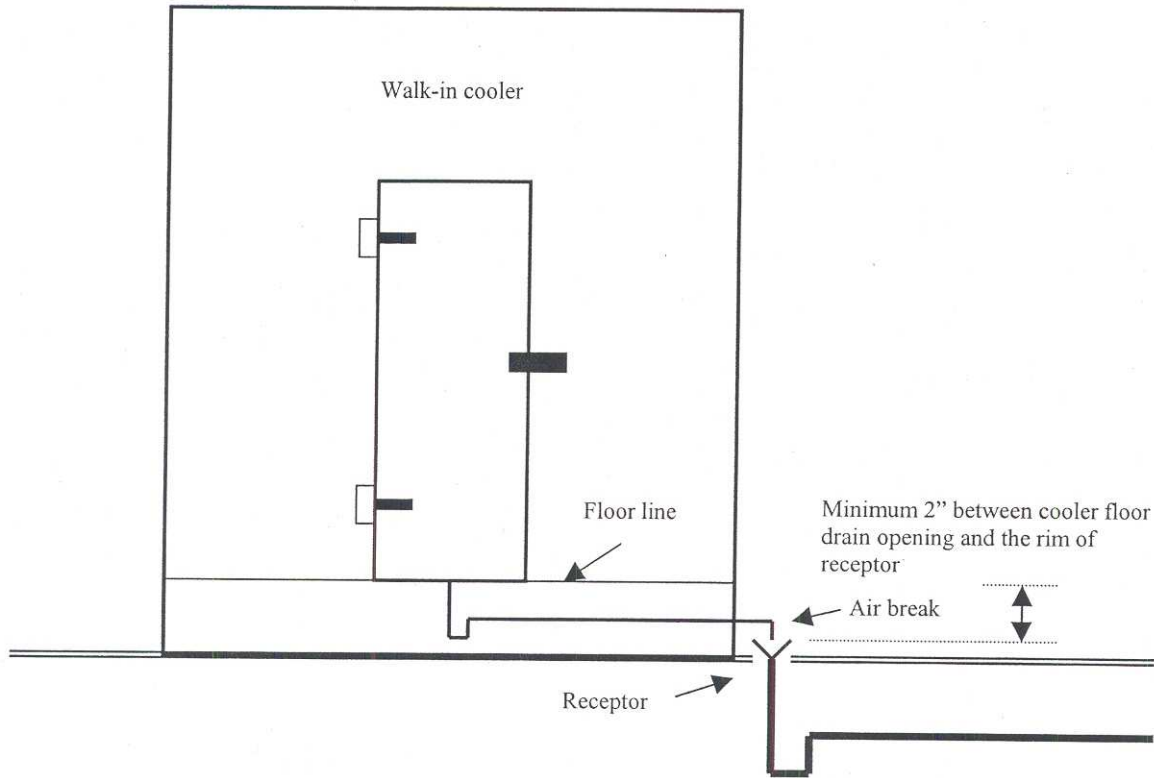

A-82.33 (9) (g) 5-1. MISCELLANEOUS FOOD HANDLING EQUIPMENT.

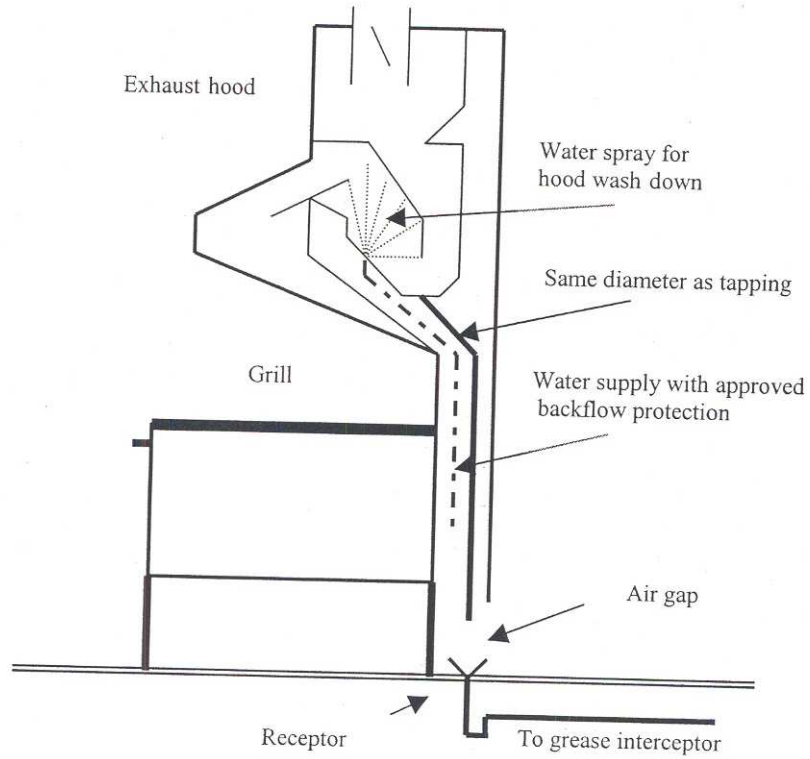

A-82.33 (9) (g) 5-2. MISCELLANEOUS FOOD HANDLING EQUIPMENT.

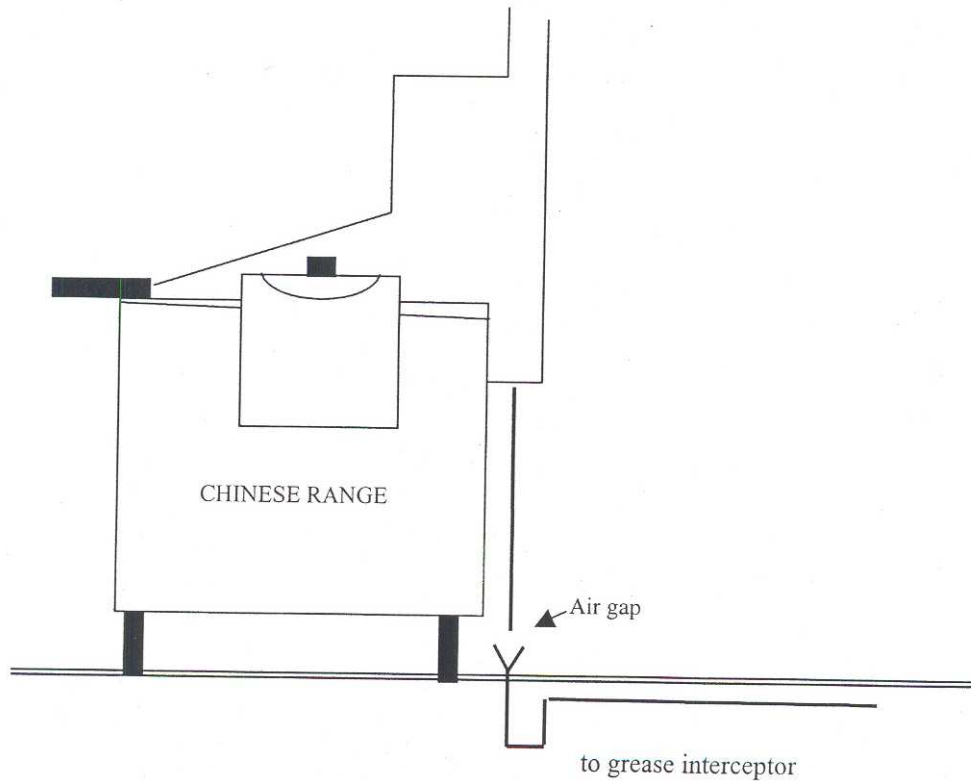

A-82.34 (4)-1. GARAGE CATCH BASINS.

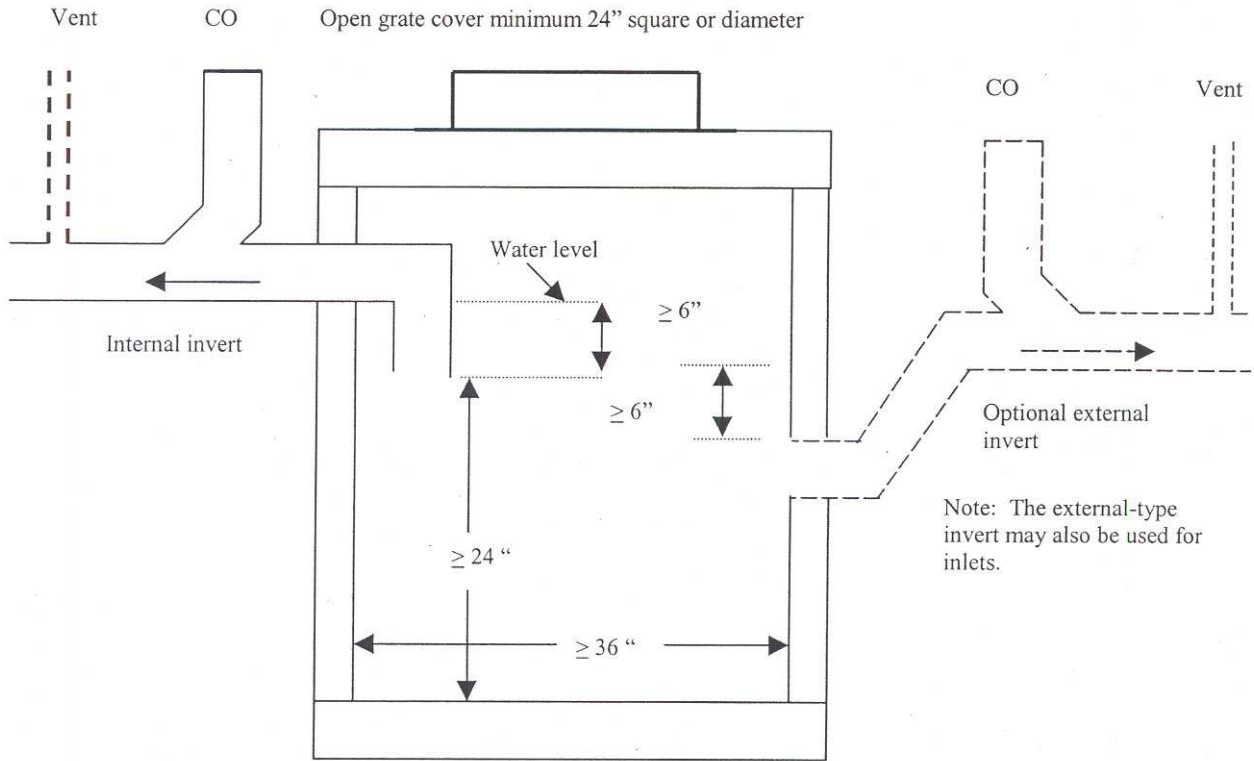

A-82.34 (4)-2. TRAPPED FIXTURES DISCHARGING TO CATCH BASIN.

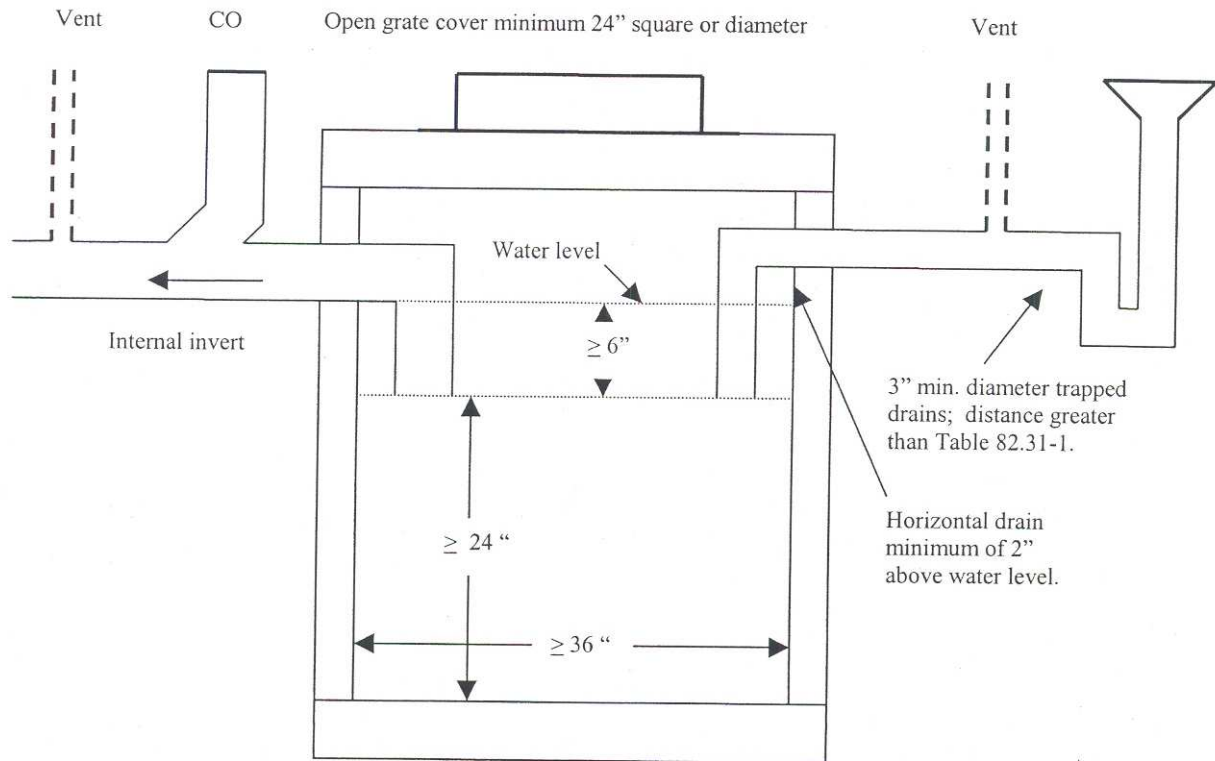

A-82.34 (4)-3. TRAPPED FIXTURE DISCHARGING INTO GARAGE CATCH BASIN.

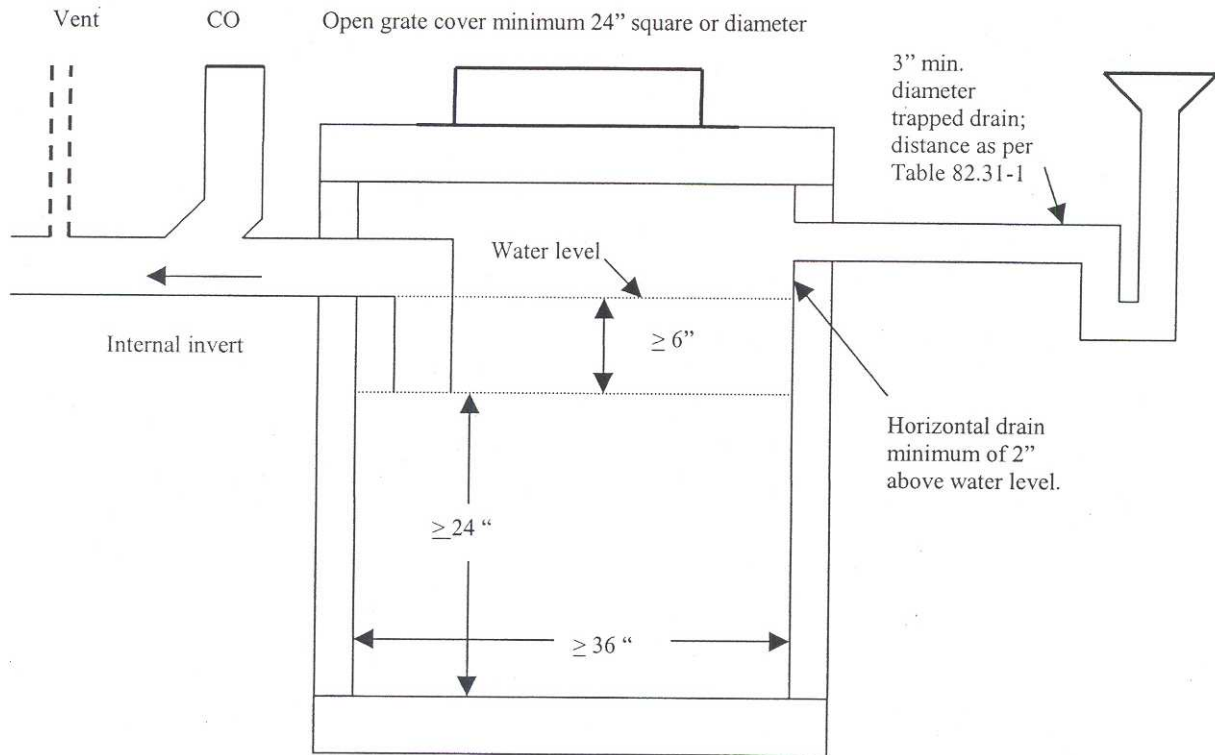

A-82.34 (4)-4. FIXTURES WITHOUT TRAPS DISCHARGING TO CATCH BASIN.

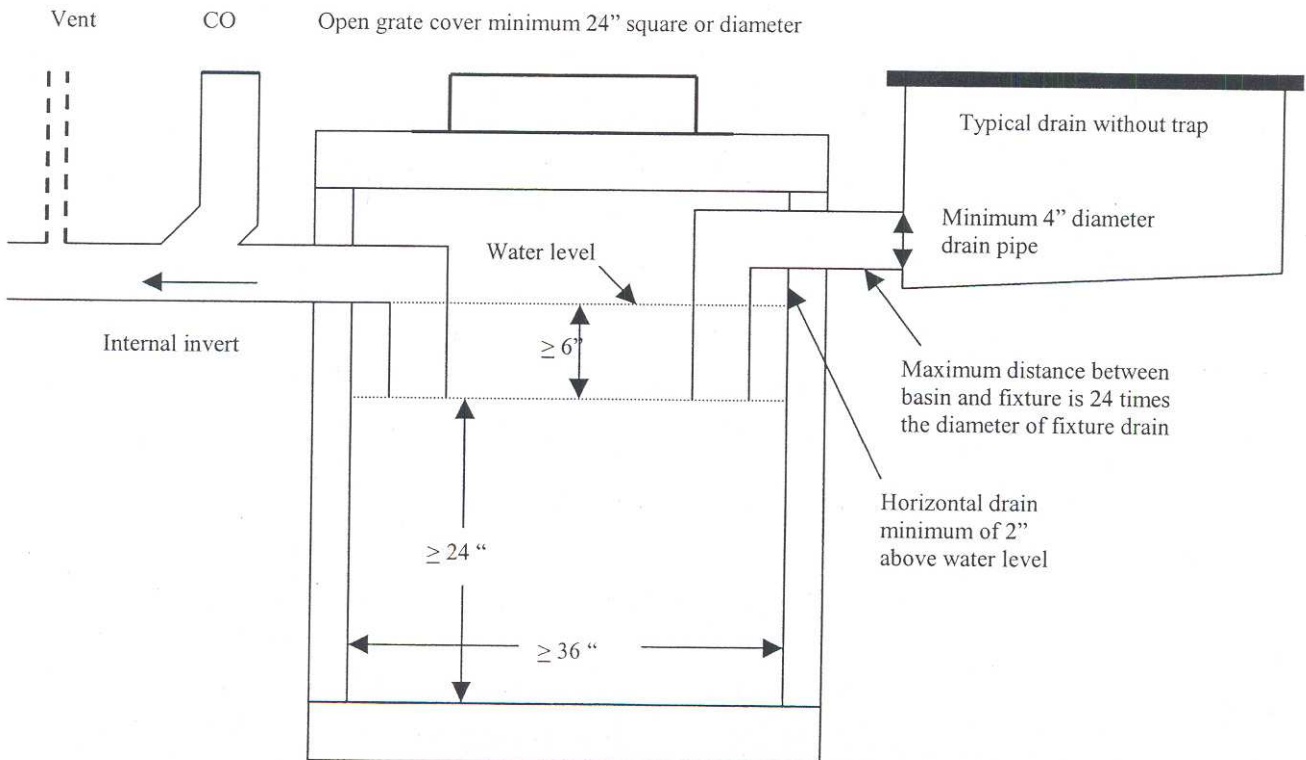

A-82.34 (4)-5. GARAGE CATCH BASIN WITH FIXTURES ON SEPARATE FLOOR LEVELS.

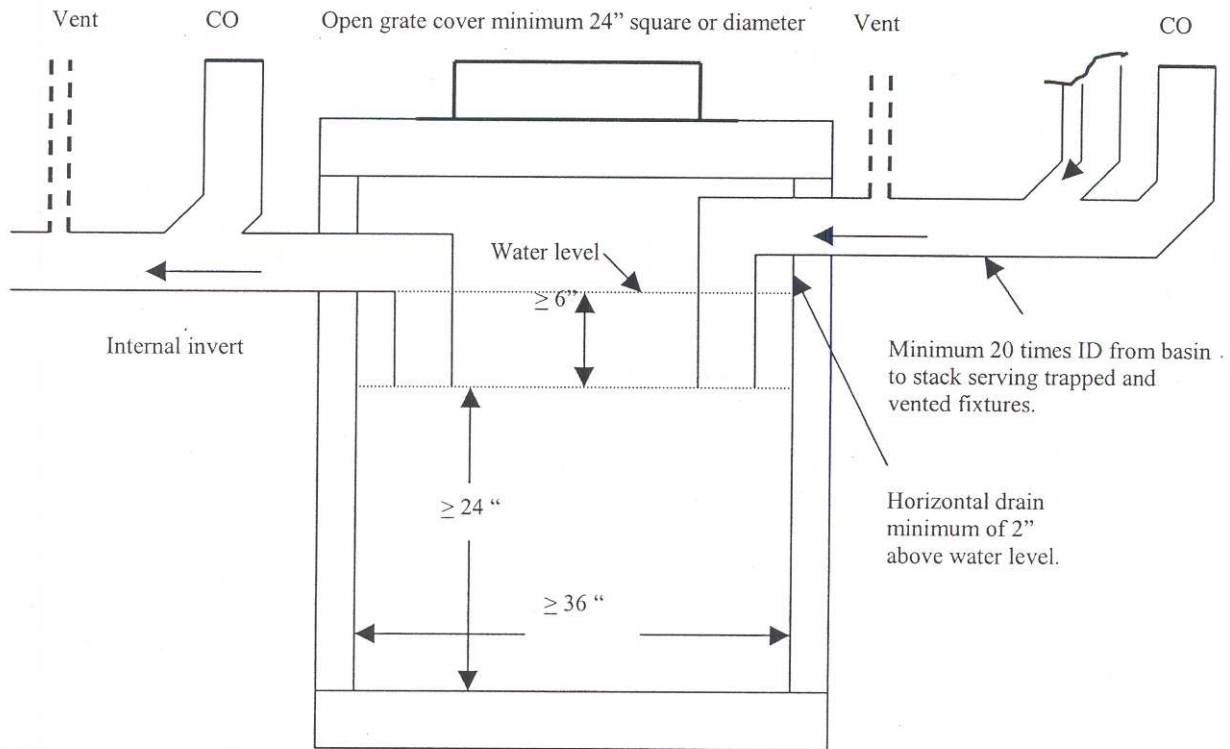

A-82.34 (4)-6. GARAGE CATCH BASIN RECEIVING PRESSURIZED DRAINS.

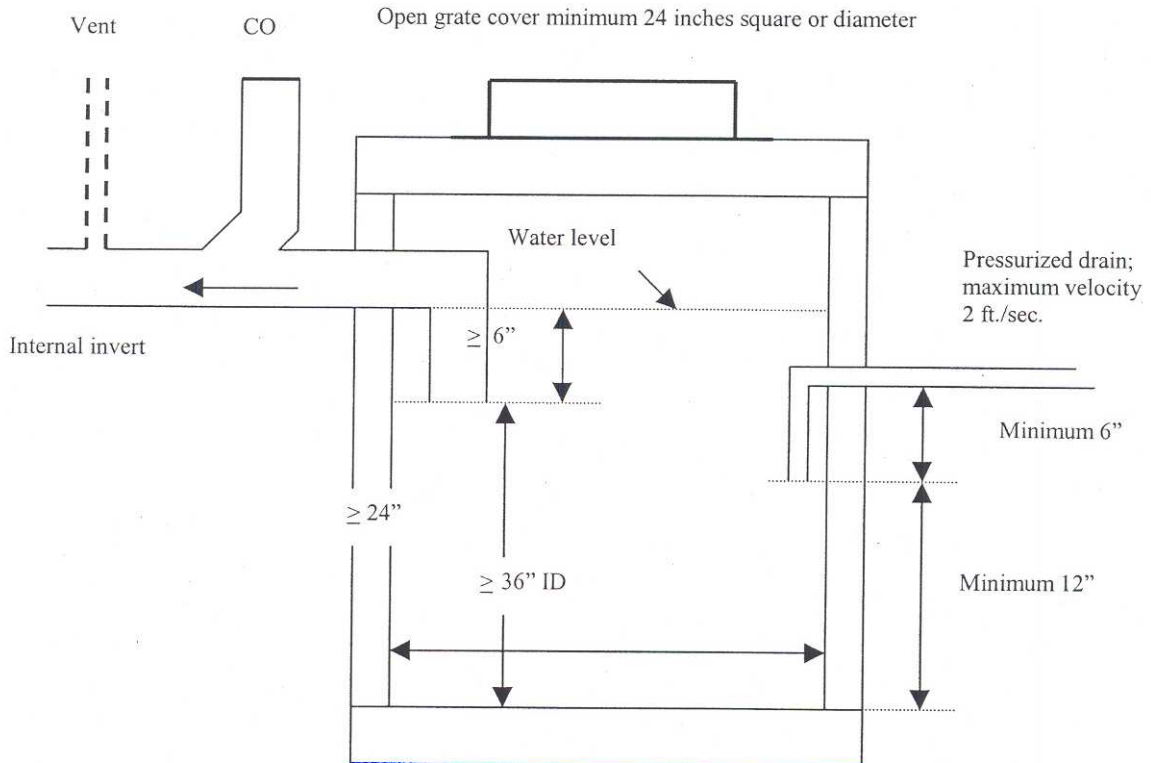

A-82.34 (5) (b)-1. EXTERIOR GREASE INTERCEPTORS.

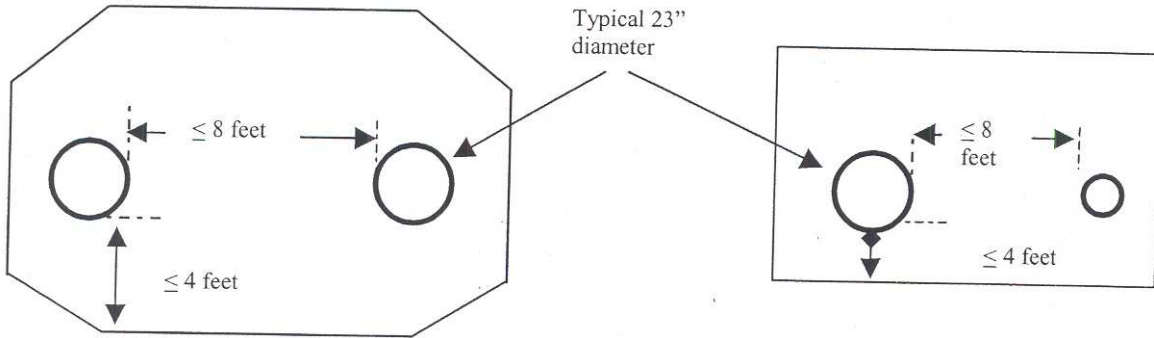

GREASE INTERCEPTOR MANHOLE LOCATION

A-82.34 (5) (b)-2. EXTERIOR GREASE INTERCEPTORS.

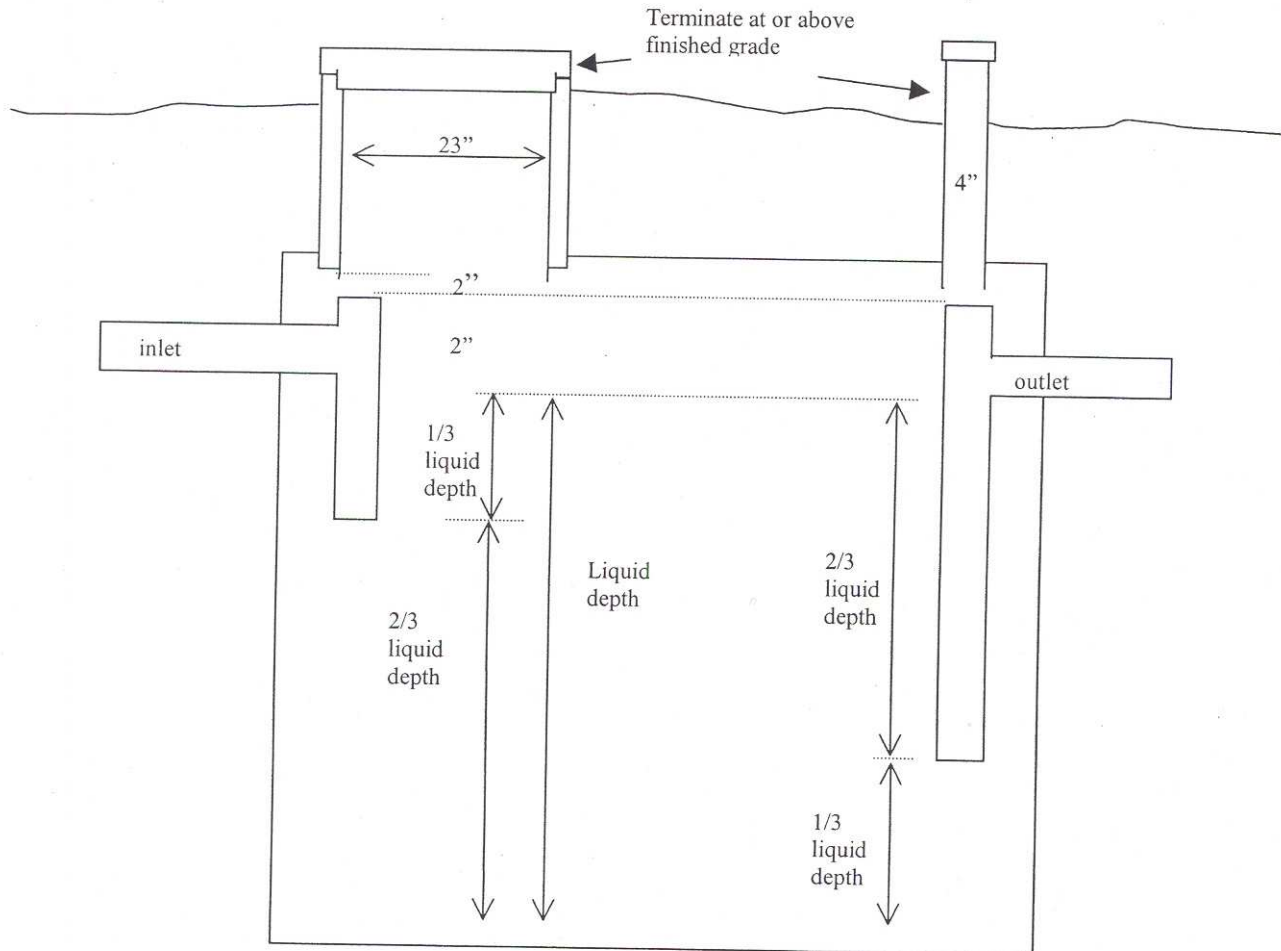

A-82.34 (5) (c) INTERIOR GREASE INTERCEPTORS.

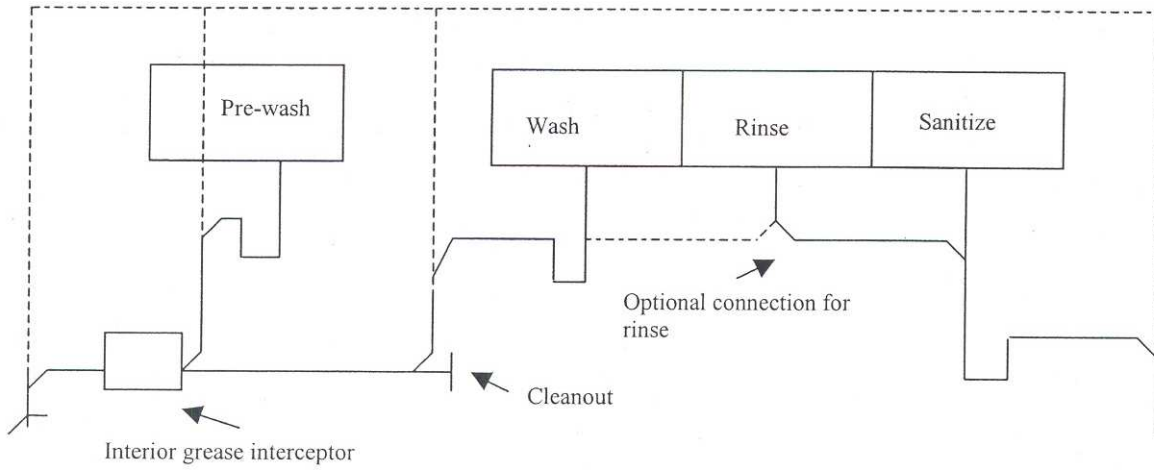

PRE-WASH AND 3-COMPARTMENT SCULLERY SINK

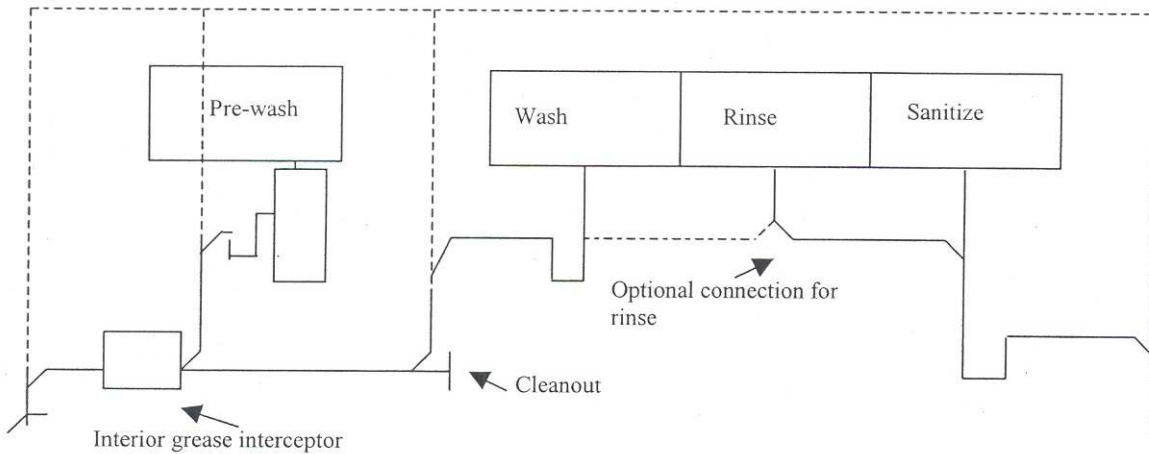

PRE-WASH WITH DISPOSAL AND 3-COMPARTMENT SCULLERY SINK

A-82.34 (6) AUTOMATIC CAR WASHES.

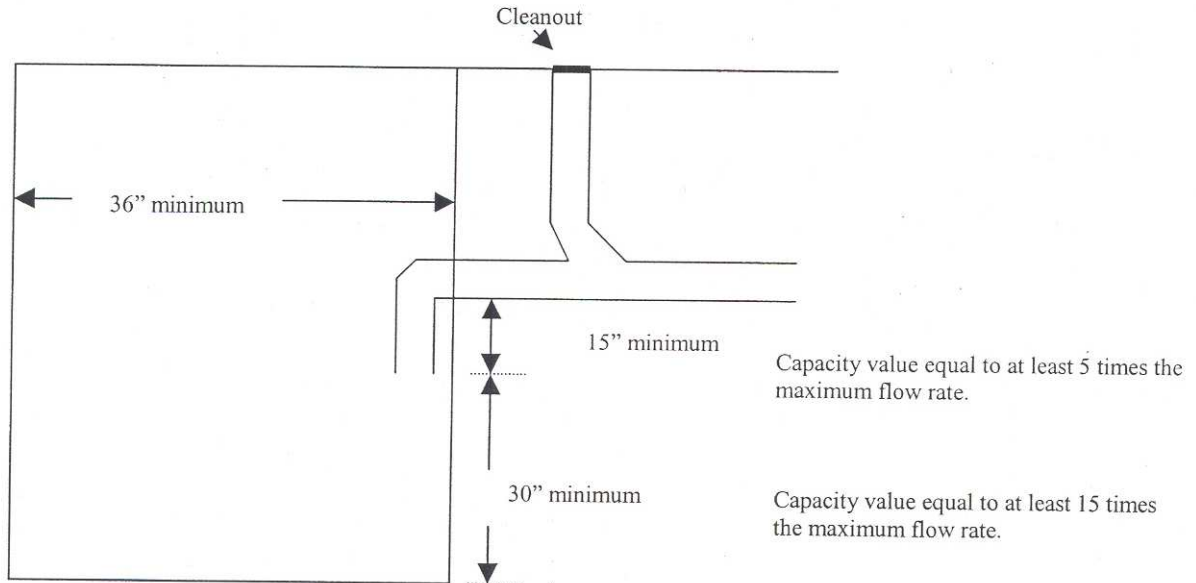

CAR WASH INTERIOR WITH INVERT INSIDE OF BASIN

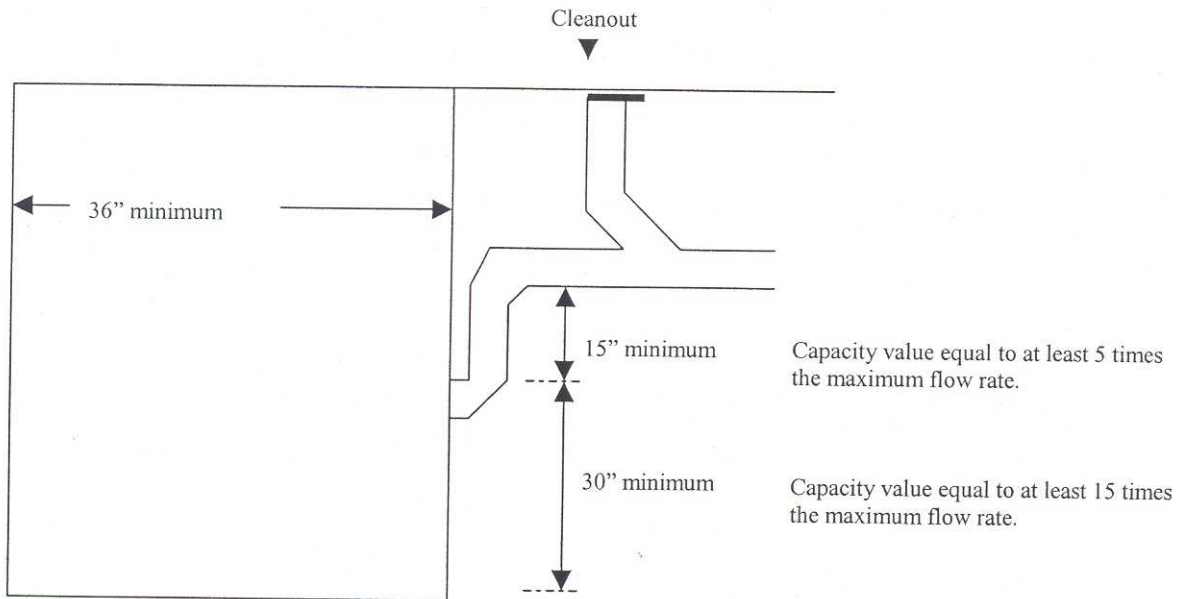

CAR WASH INTERIOR WITH INVERT OUTSIDE OF BASIN

A-82.34 (7) COMMERCIAL LAUNDRIES.

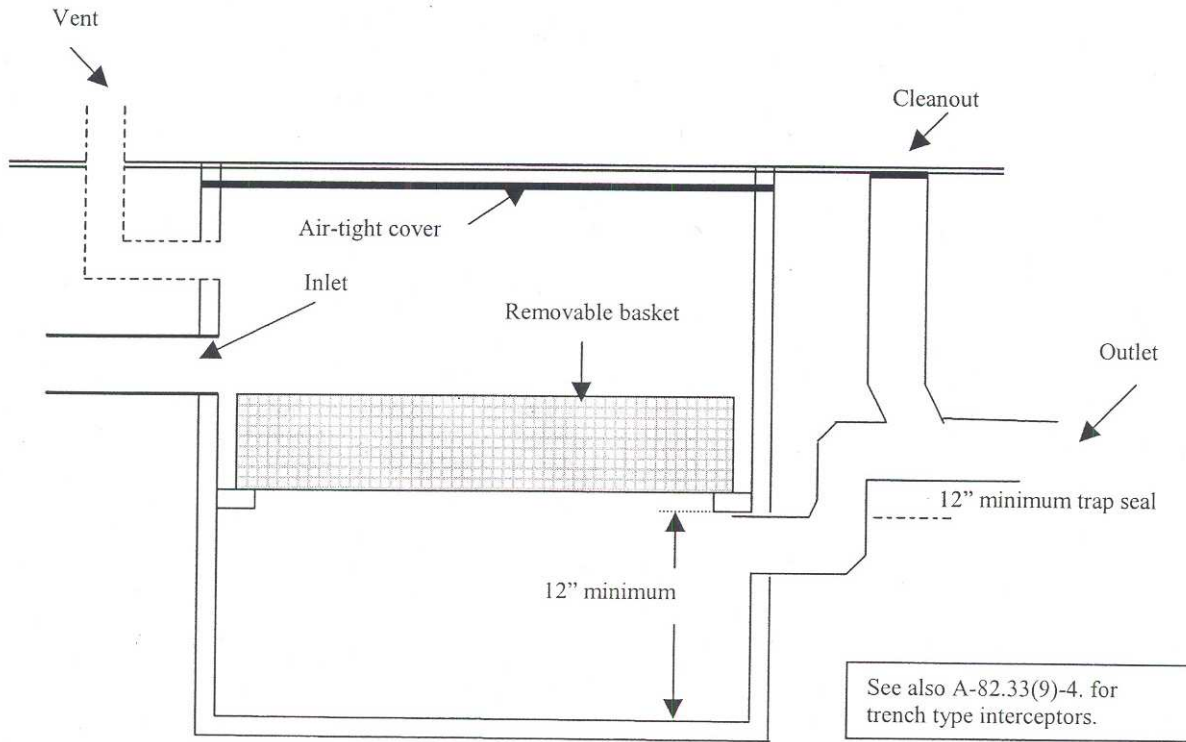

IN LINE LAUNDRY INTERCEPTOR

A-82.34 (8) OIL AND FLAMMABLE LIQUIDS INTERCEPTOR.

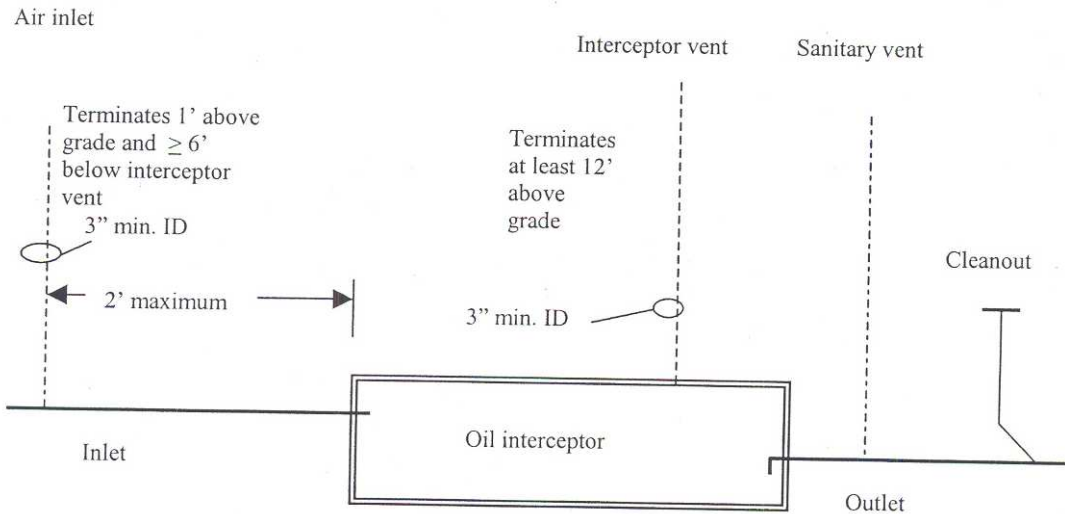

VENTS AS SHOWN MUST TERMINATE INDEPENDENTLY.

A-82.34 (13) PLASTER AND HEAVY SOLIDS TRAP-TYPE INTERCEPTORS.

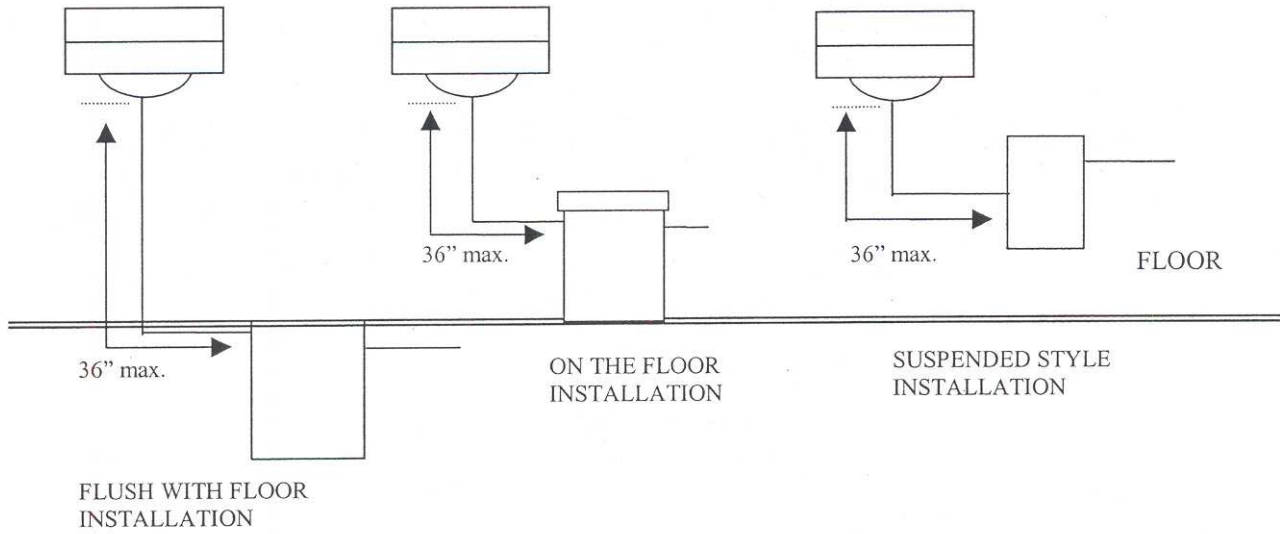

A-82.34 (14) CHEMICAL DILUTION AND NEUTRALIZING BASINS.

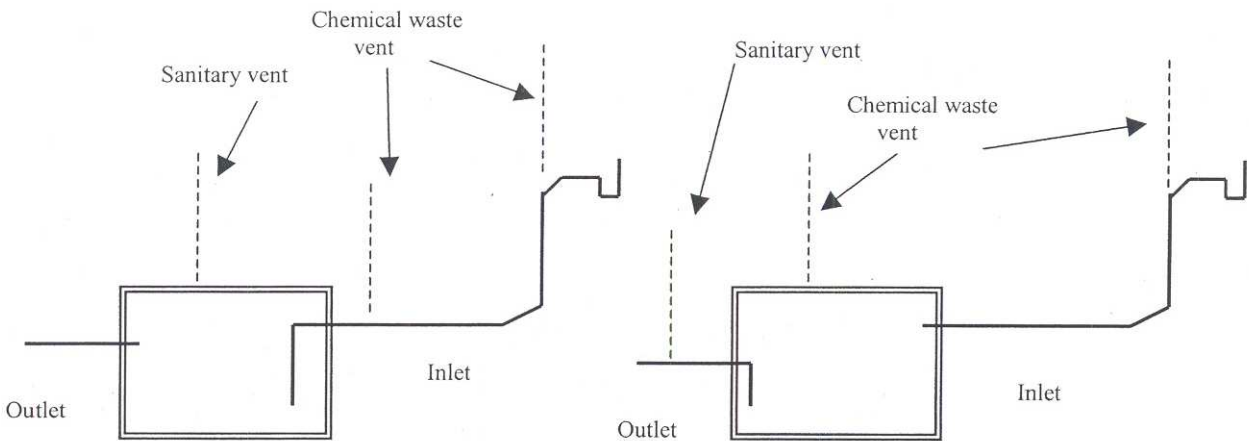

A-82.35 (3) CLEANOUTS SERVING HORIZONTAL DRAINS WITHIN OR UNDER A BUILDING.

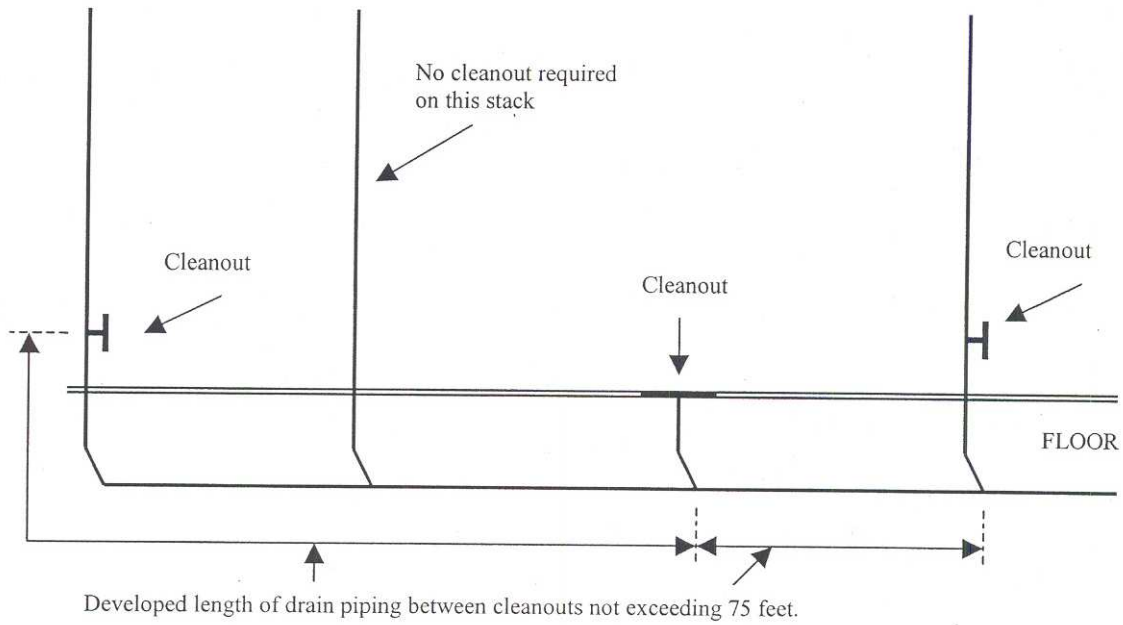

A-82.35 (5) (a) CLEANOUT EXTENSION TO GRADE.

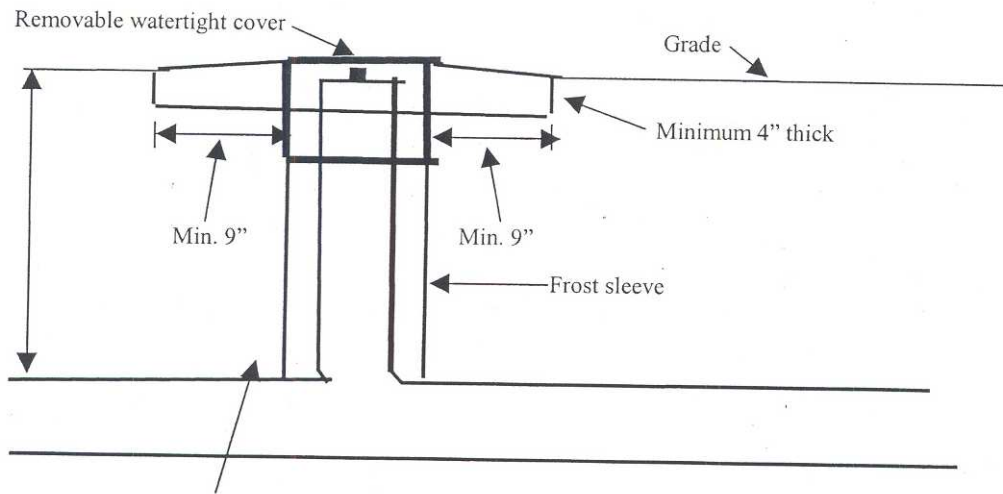
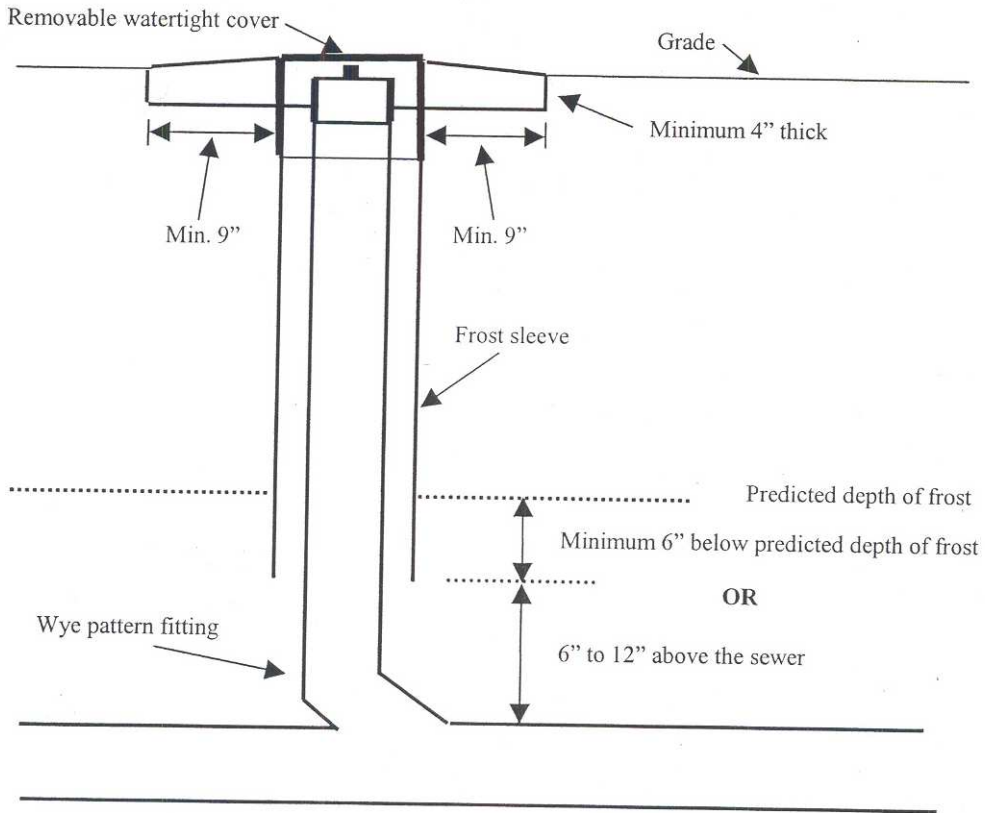

If depth is 18" or less, this may be a sanitary pattern fitting.

A-82.35 (8) OUTSIDE DROP INTO AN EXISTING MANHOLE.

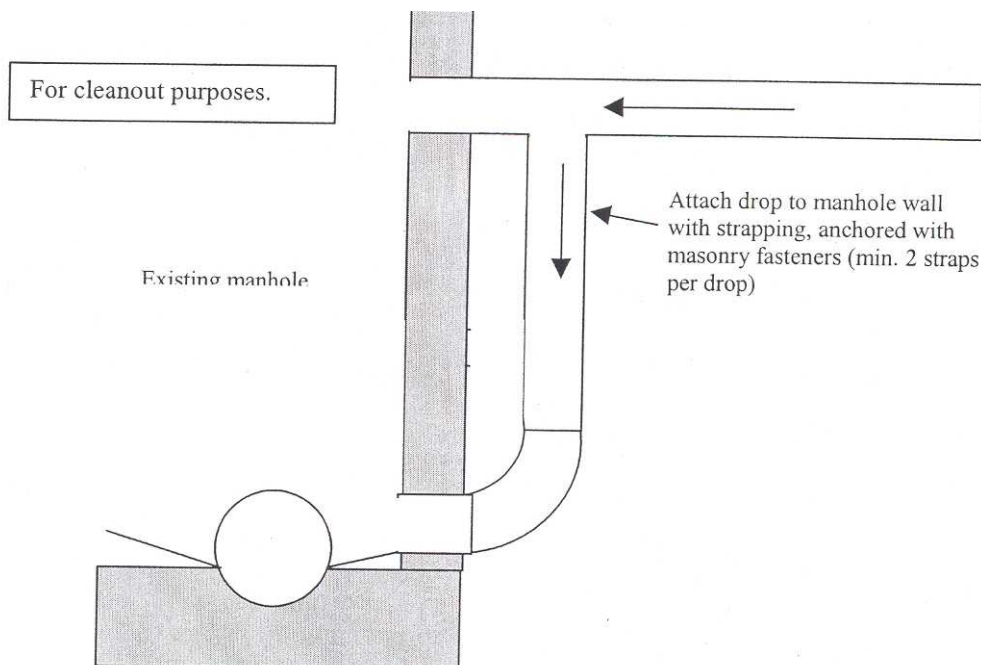

A-82.36 (3) SOURCES OF POLLUTANTS IN WISCONSIN STORMWATER.

Sources of Pollutants in Wisconsin Stormwater^a
Geometric Mean Concentrations of Contaminants in Runoff from Source-Area and Storm-Sewer Outfalls

Contaminant	Feeder Streets	Collector Streets	Arterial Streets	Lawns	Drive-ways	Roofs	Parking Lots	Outfall
Residential Source Areas								
Total Solids (mg/L)	796	493	-	600	306	91	-	369
Suspended Solids (mg/L)	662	326	-	397	173	27	-	262
Total Phosphorus (mg/L)	1.31	1/07	-	2.67	1.16	.15	-	.66
Total Recoverable Copper (µg/L)	24	56	-	13	17	15	-	16
Total Recoverable Lead (µg/L)	33	55	-	--	17	21	-	32
Total Recoverable Zinc (µg/L)	220	339	-	59	107	149	-	203
Fecal Coliform (cfu/100mL)	92,061	56,554	-	42,093	34,294	294	0	175,106
Commercial Source Areas								
Total Solids (mg/L)	-	---	373	-	-	112	127	---
Suspended Solids (mg/L)	-	---	232	-	-	15	58	---
Total Phosphorus (mg/L)	-	---	.47	-	-	.20	.19	---
Total Recoverable Copper (µg/L)	-	---	46	-	-	9	15	---
Total Recoverable Lead (µg/L)	-	---	50	-	-	9	22	---
Total Recoverable Zinc (µg/L)	-	---	508	-	-	330	178	---
Fecal Coliform (cfu/100mL)	-	---	9,627	-	-	1,117	1,758	---
Industrial Source Areas								
Total Solids (mg/L)	-	958	879	---	-	78	531	267
Suspended Solids (mg/L)	-	763	690	---	-	41	312	146
Total Phosphorus (mg/L)	-	1.5	.94	---	-	.11	.39	.34
Total Recoverable Copper (µg/L)	-	76	74	---	-	6	41	28
Total Recoverable Lead (µg/L)	-	86	60	---	-	8	38	25
Total Recoverable Zinc (µg/L)	-	479	575	---	-	1,155	304	265
Fecal Coliform (cfu/100mL)	-	8,338	4,587	---	-	144	2,705	5,114

Note: Single dash indicates source area is not in the land use; double dash indicates insufficient data; triple dash indicates values are shared with those above for the same source area.

The relatively large concentrations of zinc in roof runoff indicate that galvanized roofing materials were a source of the zinc. One-third of the residential roofs had galvanized downspouts. Roofing materials also might be a source of copper and lead in the runoff from residential roofs. Concentrations of dissolved copper and total recoverable copper and lead were slightly larger in the residential roof runoff than in runoff from driveways and lawns.

Note: The department has accepted that a "visible sheen" is defined as 15 mg/L grease and oil.

Note: In parking lot runoff, visible sheen has been accepted as having an oil concentration of 15 mg/L.

^a Source: Bannerman, R.T.; Owens D.W.; Dodds, R.B.; and Hornewer, N.J., 1993, Sources of Pollutants in Wisconsin Stormwater: Water Science Technology, v.28, no. 3-5, p. 241-259.

A-82.36 (3)-1. BEST MANAGEMENT PRACTICES (BMPs). A description of the proposed best management practices to be used for stormwater management in the protection of water quality include, but are not limited to, the following:

- a. Detention, retention and sedimentation facilities, including plans for discharges from the facilities, maintenance plans and predictions of water quality.
- b. Areas of the site to be used or reserved for infiltration including a prediction of the impact on groundwater quality.
- c. Any other relevant volume controls or measures.
- d. Any other relevant source control practices not described.
- e. Any treatment device, including plans for discharges from the facilities, maintenance plans and predictions of water quality.

Note: Section NR 151.002 (4) reads: ““Best management practices” or “BMPs” means structural or non-structural measures, practices, techniques or devices employed to avoid or minimize soil, sediment or pollutants carried in runoff to waters of the state.’

A-82.36 (4)-1. RATIONAL METHOD. The equation procedure for using the rational method formula.

$$Q = Aci \text{ (in cubic feet per second)}$$

- Where:
- Q = Runoff (in cubic feet per second)
 - A = Drainage area (in acres)
 - c = Coefficient of runoff (a dimensionless number)
 - i = Intensity of rainfall (in inches per hour)

$$Q = (0.0104)ciA \text{ (in gallons per minute)}$$

$$(1/96)ciA$$

- Where:
- Q = Runoff (in gallons per minute)
 - c = Coefficient of runoff (a dimensionless number)
 - i = Intensity of rainfall (in inches per hour)
 - A = Drainage area (in square feet)

A-82.36 (4)-2. RUNOFF COEFFICIENTS. Tables Detail A and B for using the rational formula.

DETAIL A: RUNOFF COEFFICIENTS (C), RATIONAL FORMULA

Note: The department has accepted that a “visible sheen” is defined as 15 mg/L grease and oil.

Land Use	Per- cent Imper- vious Area	Design Storm 24-Hour Event	Hydrologic Soil Group											
			A			B			C			D		
			Slope Range (%)			Slope Range (%)			Slope Range (%)			Slope Range (%)		
			0 - 2	2 - 6	> 6	0 - 2	2 - 6	> 6	0 - 2	2 - 6	> 6	0 - 2	2 - 6	> 6
Industrial	90	2 - and 10-year	0.67	0.58	0.68	0.68	0.68	0.69	0.68	0.69	0.69	0.69	0.69	0.70
		25-, 50-, and 100-year	0.85	0.85	0.86	0.85	0.86	0.86	0.86	0.86	0.86	0.87	0.86	0.86
Commer- cial	95	2 - and 10-year	0.71	0.71	0.72	0.71	0.72	0.72	0.72	0.72	0.72	0.72	0.72	0.72
		25-, 50-, and 100-year	0.88	0.89	0.89	0.89	0.89	0.89	0.89	0.89	0.89	0.89	0.89	0.89
Residen- tial: High- density (>6 units/ acre)	60	2 - and 10-year	0.47	0.49	0.50	0.48	0.50	0.52	0.49	0.51	0.54	0.51	0.53	0.56
		25-, 50-, and 100-year	0.58	0.60	0.61	0.59	0.61	0.64	0.60	0.62	0.66	0.62	0.66	0.69
Medium- density (2-6 units/acre)	30	2 - and 10-year	0.25	0.28	0.31	0.27	0.30	0.35	0.30	0.33	0.38	0.33	0.36	0.42
		25-, 50-, and 100-year	0.33	0.37	0.40	0.35	0.39	0.44	0.38	0.42	0.49	0.41	0.45	0.54
Low-den- sity (0.7-2 units/acre)	15	2 - and 10-year	0.14	0.19	0.22	0.17	0.21	0.26	0.20	0.25	0.31	0.24	0.28	0.35
		25-, 50-, and 100-year	0.22	0.26	0.29	0.24	0.28	0.34	0.28	0.32	0.40	0.31	0.35	0.46
Agricul- ture	5	2 - and 10-year	0.08	0.13	0.16	0.11	0.15	0.21	0.14	0.19	0.26	0.18	0.23	0.31
		25-, 50-, and 100-year	0.14	0.18	0.22	0.16	0.21	0.28	0.20	0.25	0.34	0.24	0.29	0.41
Open Space	2	2 - and 10-year	0.05	0.10	0.14	0.08	0.13	0.19	0.12	0.17	0.24	0.16	0.21	0.28
		25-, 50-, and 100-year	0.11	0.16	0.20	0.14	0.19	0.26	0.18	0.23	0.32	0.22	0.27	0.39
Freeways and Express- ways	70	2 - and 10-year	0.57	0.59	0.60	0.58	0.60	0.61	0.59	0.61	0.63	0.60	0.62	0.64
		25-, 50-, and 100-year	0.70	0.71	0.72	0.71	0.72	0.74	0.72	0.72	0.73	0.76	0.75	0.78

Source: Wisconsin department of transportation, (WDOT), Facilities Development Manual (July 2, 1979), Procedure 13-10-5.

DETAIL B: RUNOFF COEFFICIENTS (C), FOR SPECIFIC LAND USE

Land Use	Design Storm 24-Hour Event	Hydrologic Soil Group											
		A			B			C			D		
		Slope Range (%)			Slope Range (%)			Slope Range (%)			Slope Range (%)		
		0-2	2-6	>6	0-2	2-6	>6	0-2	2-6	>6	0-2	2-6	>6
Row Crops	2- and 10-year	0.08	0.16	0.22	0.12	0.20	0.27	0.15	0.24	0.33	0.19	0.28	0.38
	25-, 50-, and 100-year	0.22	0.30	0.38	0.16	0.34	0.44	0.30	0.37	0.50	0.34	0.41	0.56
Median Strip, turf	2- and 10-year	0.19	0.20	0.24	0.19	0.22	0.26	0.20	0.23	0.30	0.20	0.25	0.30
	25-, 50-, and 100-year	0.24	0.26	0.30	0.25	0.28	0.33	0.26	0.30	0.37	0.27	0.32	0.40
Slide Slope, turf	2- and 10-year	—	—	0.25	—	—	0.27	—	—	0.28	—	—	0.30
	25-, 50-, and 100-year	—	—	0.32	—	—	0.34	—	—	0.36	—	—	0.38
Pavement:													
Asphalt													
0.70 - 0.8													
Brick													
0.70 - 0.95													
Concrete													
0.80 - 0.95													
Drives and Walks													
0.75 - 0.85													
Roofs													
0.75 - 0.95													
Gravel-Roads and Shoulders													
0.40 - 0.60													

Source: Wisconsin department of transportation, (DOT), Facilities Development Manual (July 2, 1979), Procedure 13-10-5.

Note: The lower "C" values in each range should be used with the relatively low intensities associated with 2- to 10-year design recurrence intervals whereas the higher "C" values should be used for intensities associated with the longer 25- to 100-year design recurrence intervals.

Note: In parking lot runoff, visible sheen has been accepted as having an oil concentration of 15 mg/L.

^a Source: Bannerman, R.T.; Owens D.W.; Dodds, R.B.; and Hornewer, N.J., 1993, Sources of Pollutants in Wisconsin Stormwater: Water Science Technology, v.28, no. 3-5, p. 241-259.

A-82.36 (4)-3. OTHER METHODS OR MODELS. A model that calculates peak flow such as TR-55, P8 or an equivalent methodology may be used.

Information on how to access P8 is available at the department of natural resources webpage: <http://www.dnr.state.wi.us/org/water/wm/nps/slam.html> or contact the stormwater coordinator in the runoff management section of the bureau of watershed management at the department of natural resources at phone 608-267-7694.

A simplified TR-55 approach, TR-55 (210-vf-TR-55, second edition, June 1986), may be obtained by accessing the USDA NRCS webpage: <http://www.wcc.nrcs.usda.gov/water/quality/common/tr55/tr55.html>.

A-82.36 (6)-1. THE FORMULA FOR SOLVING FOR DIAMETER, D, FOR ROOF CONDUCTORS.

$$D = 1.128 \sqrt{\frac{A}{X}}$$

Where, A = the area of the roof in square feet.

X = one of the following:

300 square feet per square inch for a roof covered with gravel or slag and with a pitch not exceeding ¼ inch per foot.

250 square feet per square inch for a roof covered with gravel or slag and with a pitch of greater than ¼ inch per foot.

200 square feet per square inch for a roof with a metal, tile, brick or slate covering and with any pitch.

A-82.36 (9) (b) AREA DRAIN INLETS.

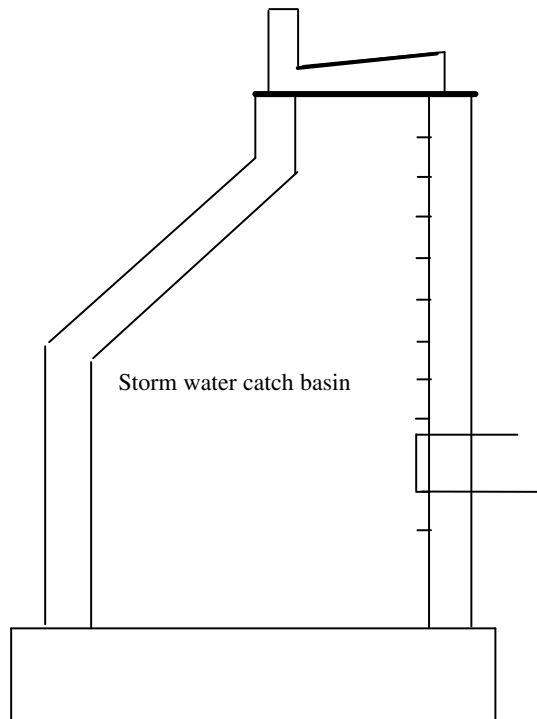
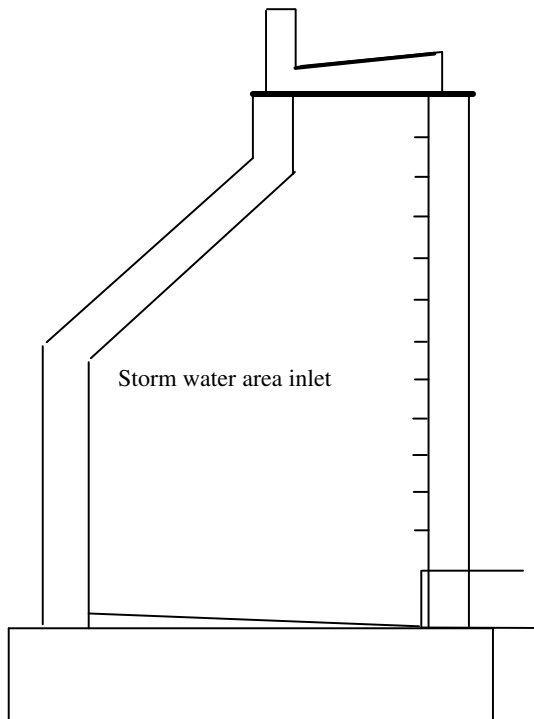

A-82.36 (9) (b) 3. INLET GRATES.

GRATES FOR HORIZONTAL PIPING

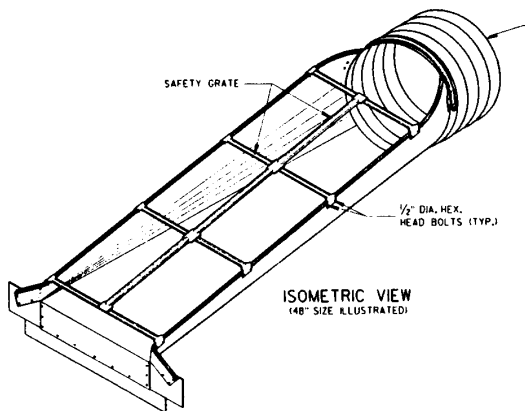

GRATES FOR VERTICAL PIPING

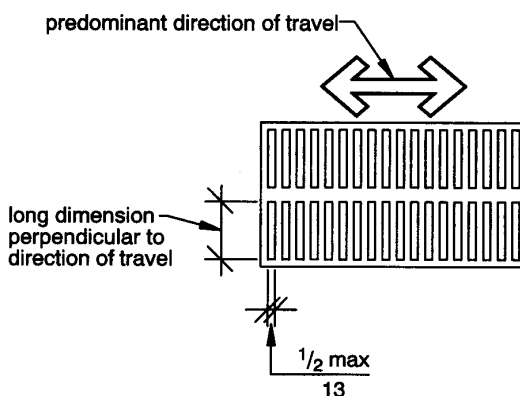

FORMULA TO CALCULATE CAPACITY, IN CUBIC FEET PER SECOND:

$$Q = 2/3 A C (2gh)^{1/2}$$

- Where:
- Q = the capacity of the inlet, cfs
 - 2/3 = a factor to correct for assumed blockage of 1/3 of the inlet's net open area
 - A = the net open area of the inlet, sq. ft
 - C = an orifice coefficient, usually taken as 0.60
 - g = a constant , 32.2 ft/sec/sec
 - h = the head, in feet on the inlet, or the depth of water on top of the inlet, usually not more than two or three inches.

A-82.365 (1) CLASS V INJECTION WELLS. An injection well is described as being any well, drilled or dug hole, used to inject fluids into the subsoil; a stormwater collection well may be a class V injection well.

Federal regulations (40 CFR 144.26) require that all injection wells be reported to the state underground injection control (UIC) program authority for the purpose of developing a state inventory of injection practices. In Wisconsin, the department of natural resources, bureau of drinking water and groundwater, maintains this inventory and registration program, form 3300-253. For further information, refer to www.dnr.state.wi.us/.

A-82.37 (3) CAMPSITE RECEPTORS AND WATER SUPPLY.

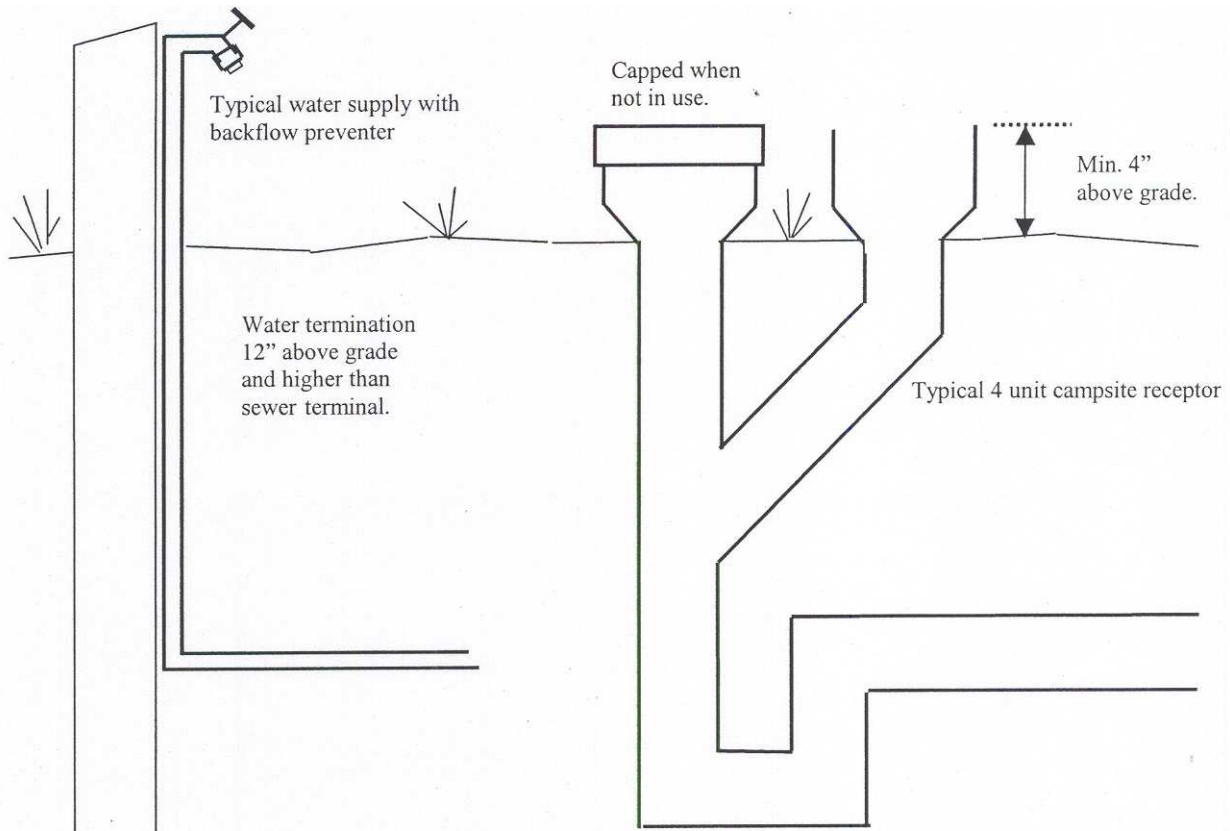

A-82.40 (4) CONTROL VALVES.

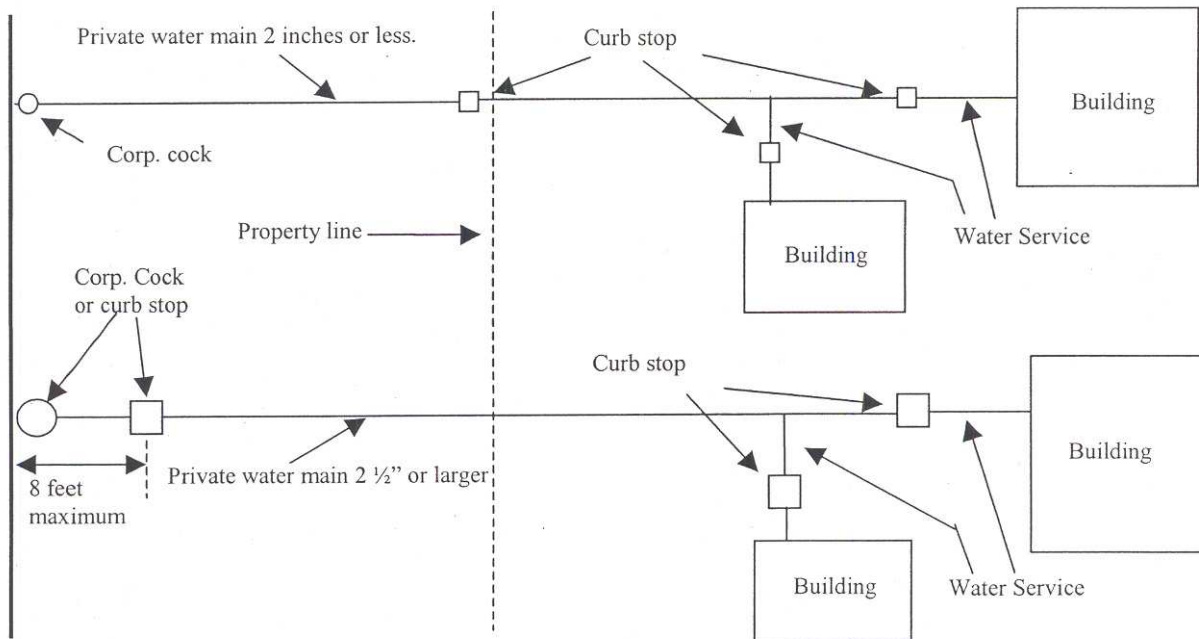

A-82.40 (5) PIPING INSULATION. The following is a reprint of s. Comm 63.1029 (1) and (2) and Table 63.1029.

Comm 63.1029 Insulation, materials and construction. (1) General. Insulation required by subs. (2) and (3) shall be suitably protected from damage. Insulation shall be installed in accordance with practices acceptable to the department. The department accepts MICA Commercial and Industrial Insulation Standards as an insulation installation practice.

(2) Piping Insulation. Except as provided in pars. (a) to (c), recirculating plumbing system piping, plumbing piping in the first 8 feet from storage tanks for noncirculating systems, any piping served by a self-regulating electric heating cable, HVAC system piping, and related HVAC fluid conveying conduit, such as heat exchanger bodies, shall be thermally insulated in accordance with Table 63.1029 or equivalent. The following piping or conduit is exempted from this subsection:

(a) Factory-installed piping or conduit within HVAC equipment tested and rated in accordance with s. Comm 63.1020;

(b) Piping or conduit for which no insulation is specified in Table 63.1029.

(c) Where it can be shown that the heat gain or heat loss to or from piping or conduit without insulation will not increase building energy use.

**Table 63.1029
Plumbing and HVAC Piping Minimum Insulation (R-value)**

Fluid Design Operating Temp. Range, °F	Insulation Conductivity ^a		Nominal Pipe Diameter					
	Conductivity Range Btu-in./-(h-ft ² ·°F)	Mean Rating Temp. °F	Runouts ^b up to 2 inches	1 inch and less	1-1/4 to 2 inches	2-1/2 to 4 inches	5 & 6 inches	8 inches & up
Heating systems (Steam, Steam Condensate, and Hot Water)								
Above 350	0.32-0.34	250	R-4.4	R-4.4	R-7.4	R-8.8	R-10.3	R-10.3
251-350	0.29-0.31	200	R-4.8	R-4.8	R-8.1	R-8.1	R-11.3	R-11.3
201-250	0.27-0.30	150	R-3.3	R-3.3	R-5.0	R-6.7	R-6.7	R-11.7
141-200	0.25-0.29	125	R-1.8	R-1.8	R-5.2	R-5.2	R-5.2	R-5.2
105-140	0.24-0.28	100	R-1.8	R-1.8	R-3.6	R-3.6	R-3.6	R-5.4
Domestic and Service Hot Water systems^c								
105 and greater	0.24-0.28	100	R-1.8	R-3.6	R-3.6	R-5.4	R-5.4	R-5.4
Cooling systems (Chilled water, brine, and refrigerant)^d								
40-55	0.23-0.27	75	R-1.9	R-1.9	R-2.8	R-3.7	R-3.7	R-3.7
Below 40	0.23-0.27	75	R-3.7	R-3.7	R-5.6	R-5.6	R-5.6	R-5.6

^a For insulation outside the state conductivity range, the minimum thickness (T) shall be determined as follows:

$$T = PR [(1+t/PR)^{K/k} - 1]$$

where T = minimum insulation thickness for material with conductivity K, in.; PR = actual outside radius of pipe, in.; t = insulation thickness, in.; K = conductivity of alternate material at mean rating temperature indicated for the application fluid temperature; and k = the lower value of the conductivity range listed for the applicable fluid temperature.

^b Runouts to individual terminal units not exceeding 12 ft. in length.

^c Applies to recirculating sections of service or domestic hot water systems and first 8 ft. from storage tank for nonrecirculating systems.

^d The required minimum thickness does not consider water vapor transmission and condensation.

A-82.40 (7) (a) METHODOLOGY.

Where equipment such as an instantaneous or tankless water heater, water treatment device, water meter and backflow preventer is provided in the design, the friction loss in such equipment, corresponding to the GPM demand, should be determined from the manufacturer or other reliable source.

Where a direct-fired, pressurized tank type water heater is provided in the design, the friction loss for such equipment can be assumed as part of the pressure losses due to flow through piping, fittings, valves and other plumbing appurtenances when the developed length of piping is multiplied by 1.5.

The pressure losses due to flow friction through displacement type cold-water meters may be calculated from Graph A-82.40 (7)-1.

Graph A-82.40 (7)-1
Pressure loss in cold-water meters, displacement type

Maximum Capacity and Pressure Loss
as Per AWWA 6700-64

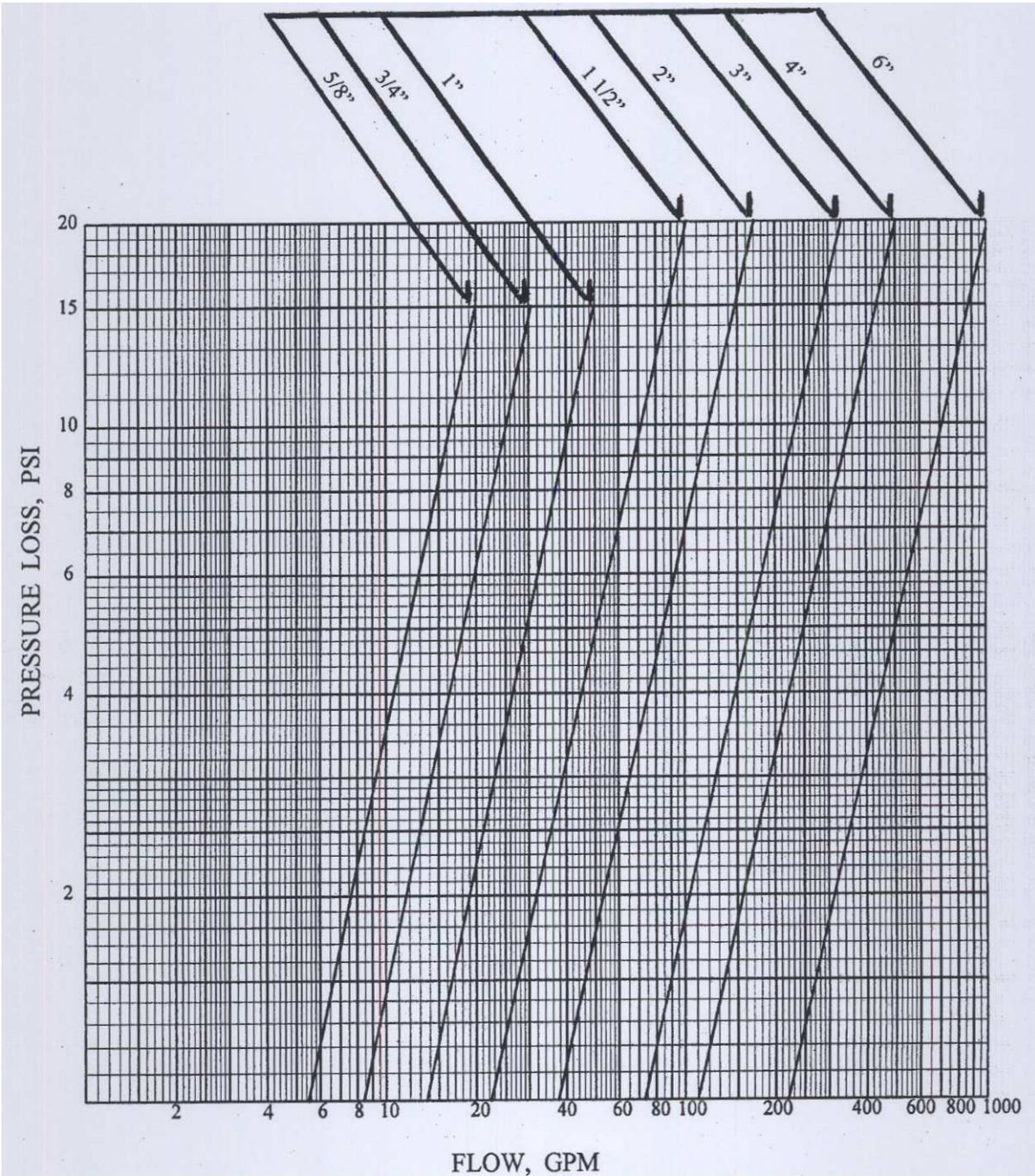

Graph A-82.40 (7)-2
Pressure losses due to flow friction
Material: Copper Tube-Type K, ASTM B88; (C = 150)

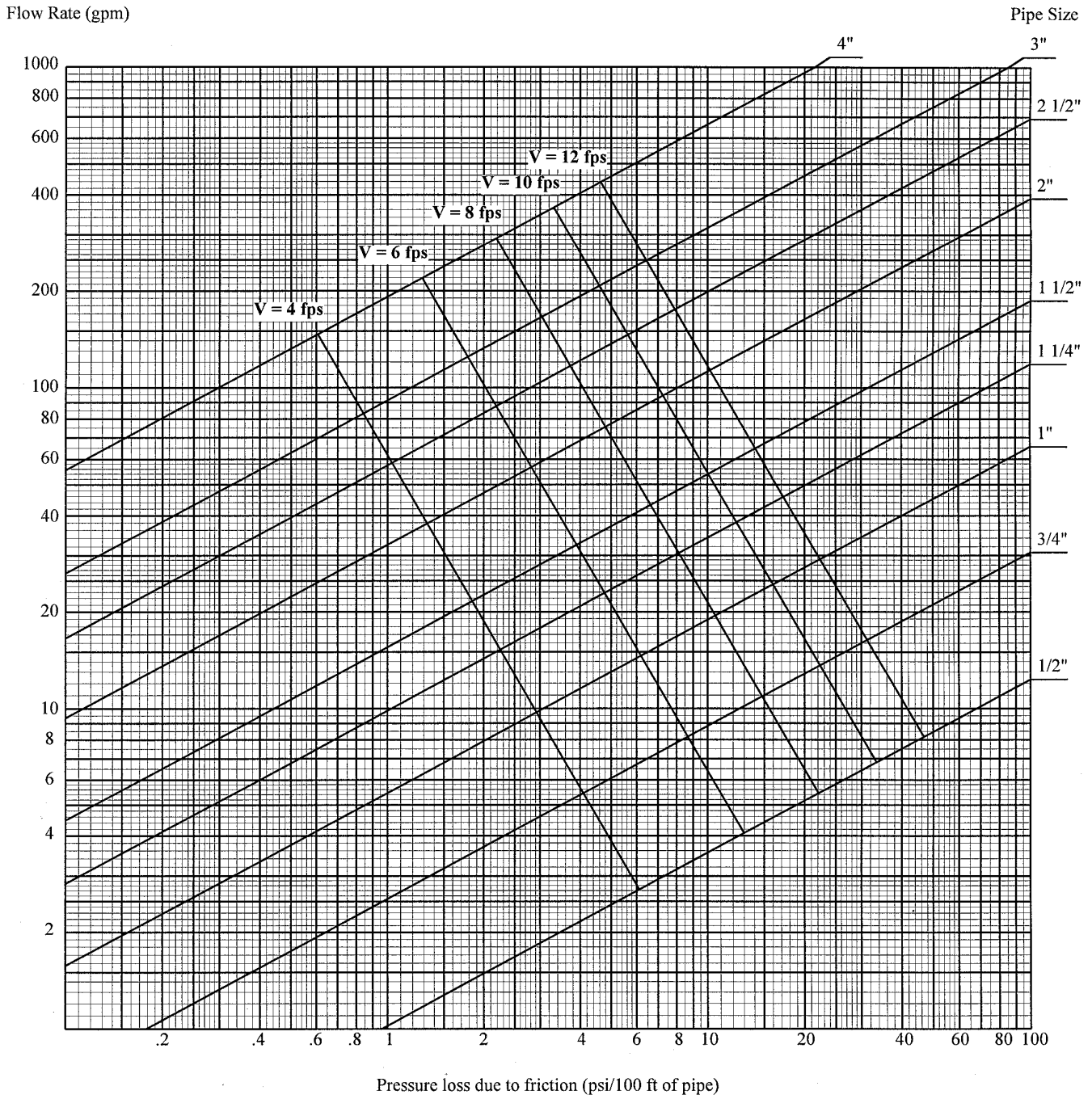

Graph A-82.40 (7)-3

Pressure losses due to flow friction
Material: Copper Tube-Type L, ASTM B88; (C = 150)

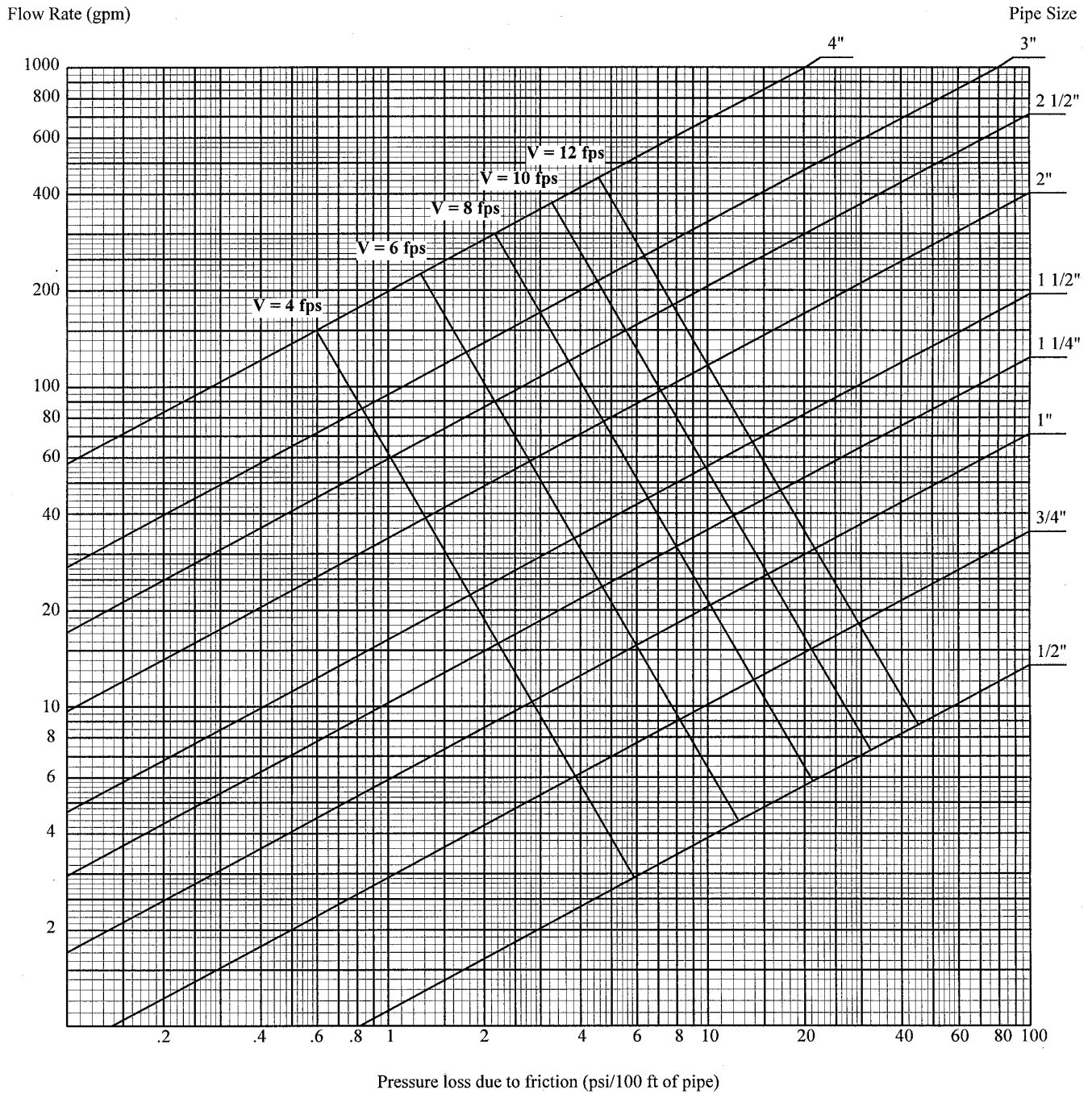

Graph A-82.40 (7)-4
Pressure losses due to flow friction
Material: Galvanized Steel Pipe-Schedule 40, ASTM A53, ASTM A120; (C = 125)

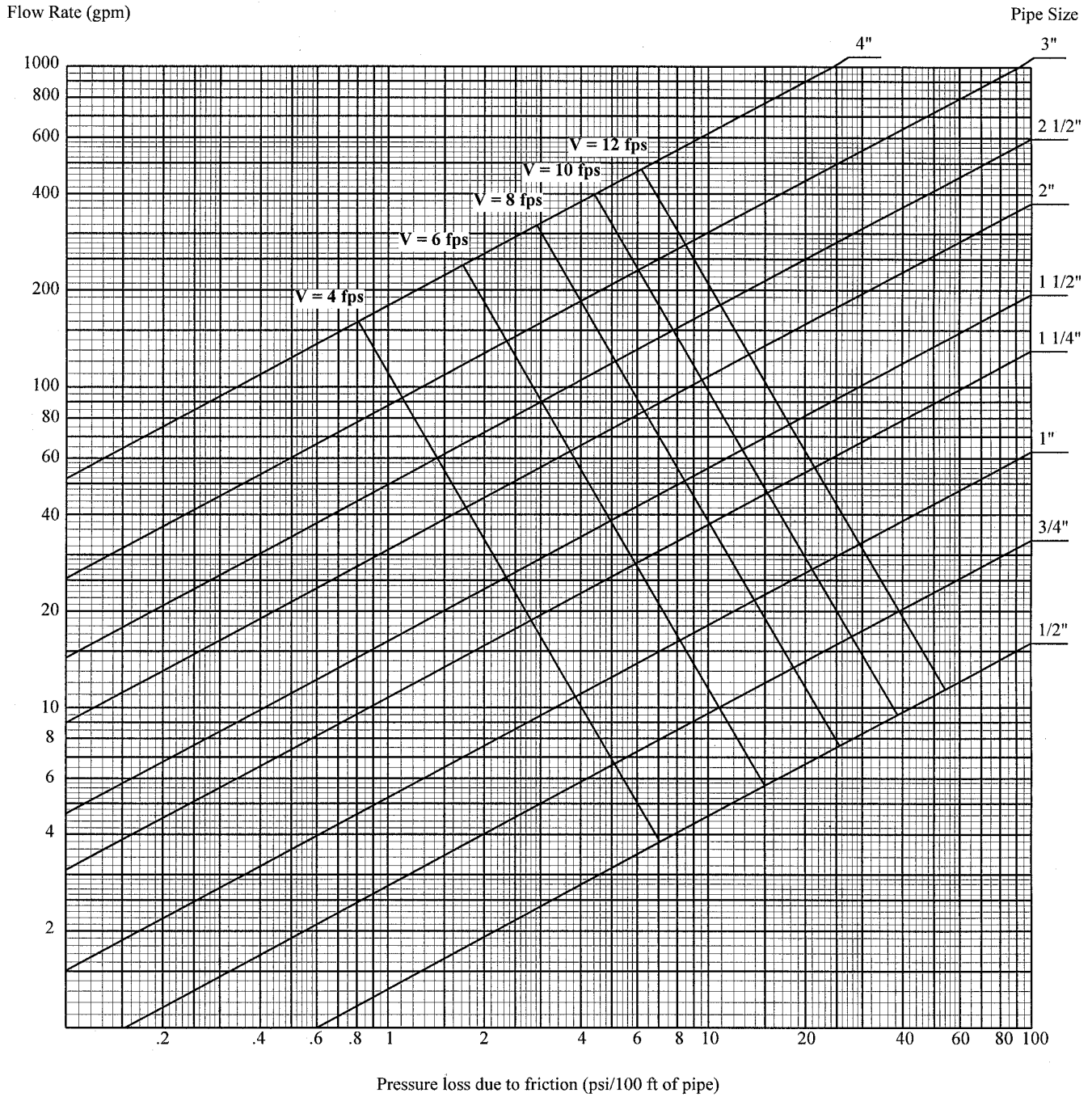

Graph A-82.40 (7)-5

Pressure losses due to flow friction
Material: Polybutylene Tubing, ASTM D3309; or
CPVC Tubing, ASTM D2846; (C = 150)

Flow Rate (gpm)

Pipe Size

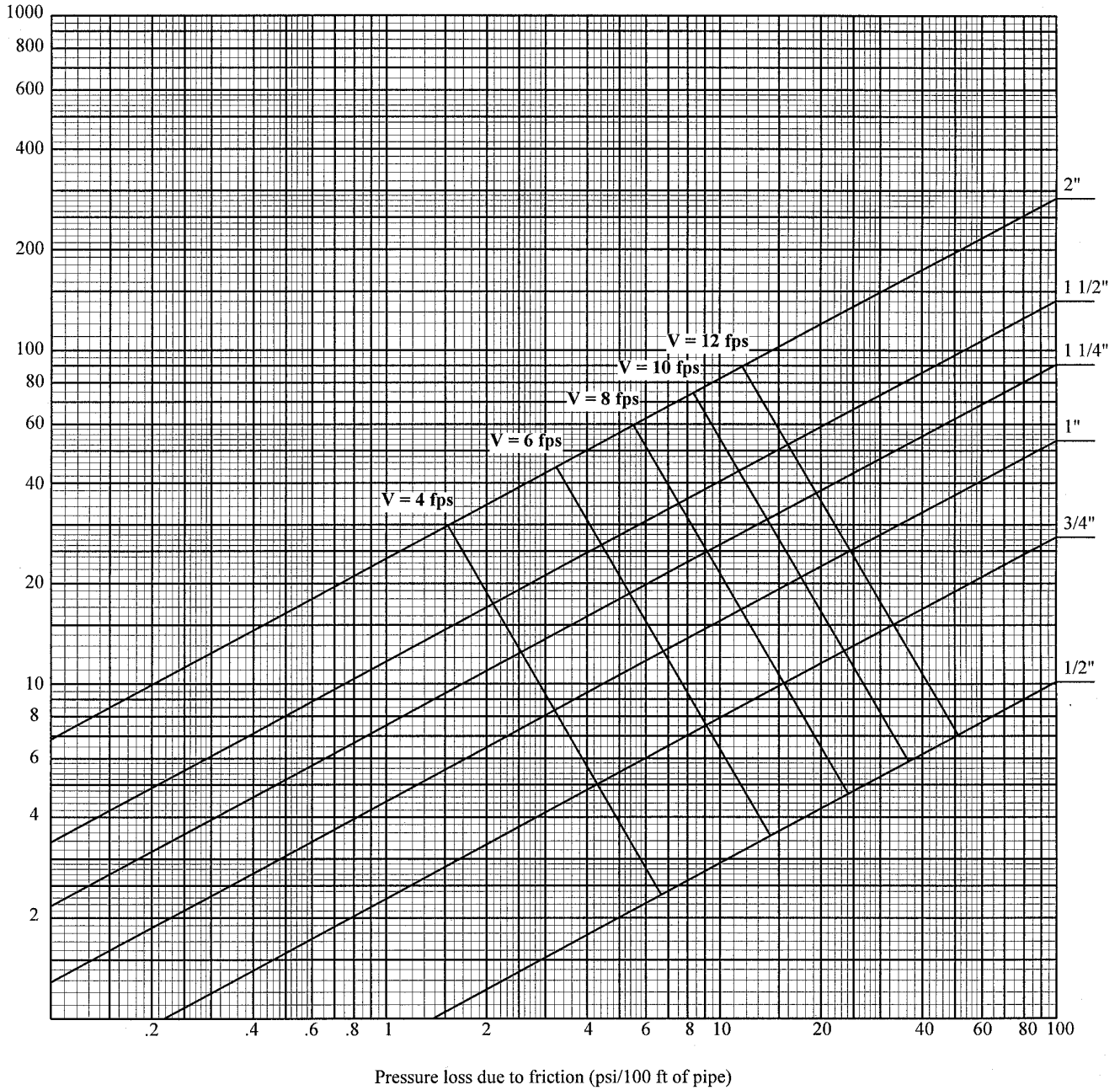

Graph A-82.40 (7)-6
Pressure losses due to flow friction
Material: Crosslinked Polyethylene (PEX) Tubing, ASTM F876; (C = 150)

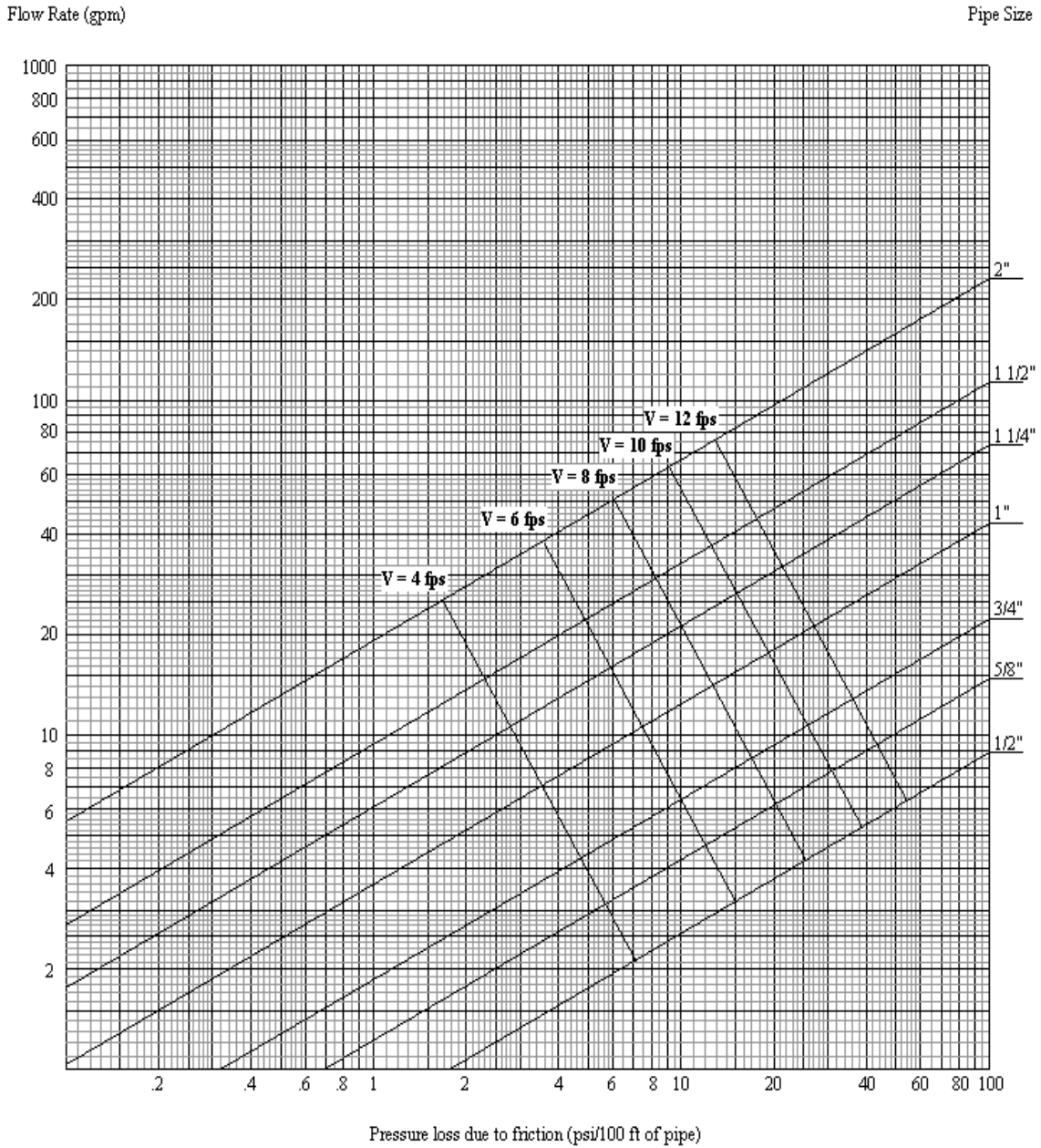

Graph A-82.40 (7)-7
Pressure losses due to flow friction
Material: Polyethylene Tubing, Copper Tube Size, ASTM D2737; (C = 150)

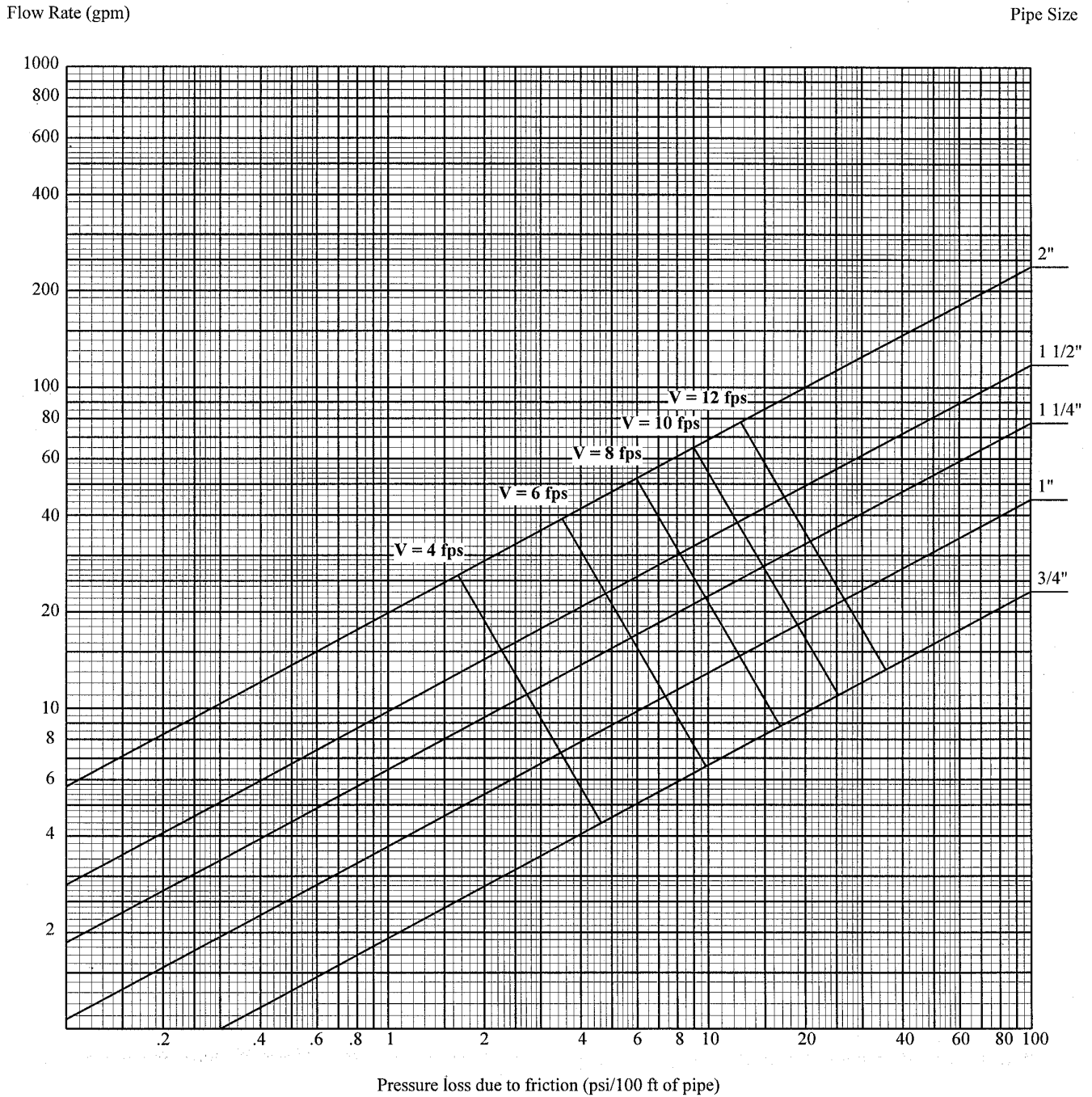

Graph A-82.40 (7)-8

Pressure losses due to flow friction

Material: ABS Pipe-Schedule 40, ASTM D1527; or

CPVC Pipe-Schedule 40, ASTM F441; or

PE Pipe-Schedule 40, ASTM D2104; ASTM D2447; or

PVC Pipe-Schedule 40, ASTM D1785; ASTM D2672; (C = 150)

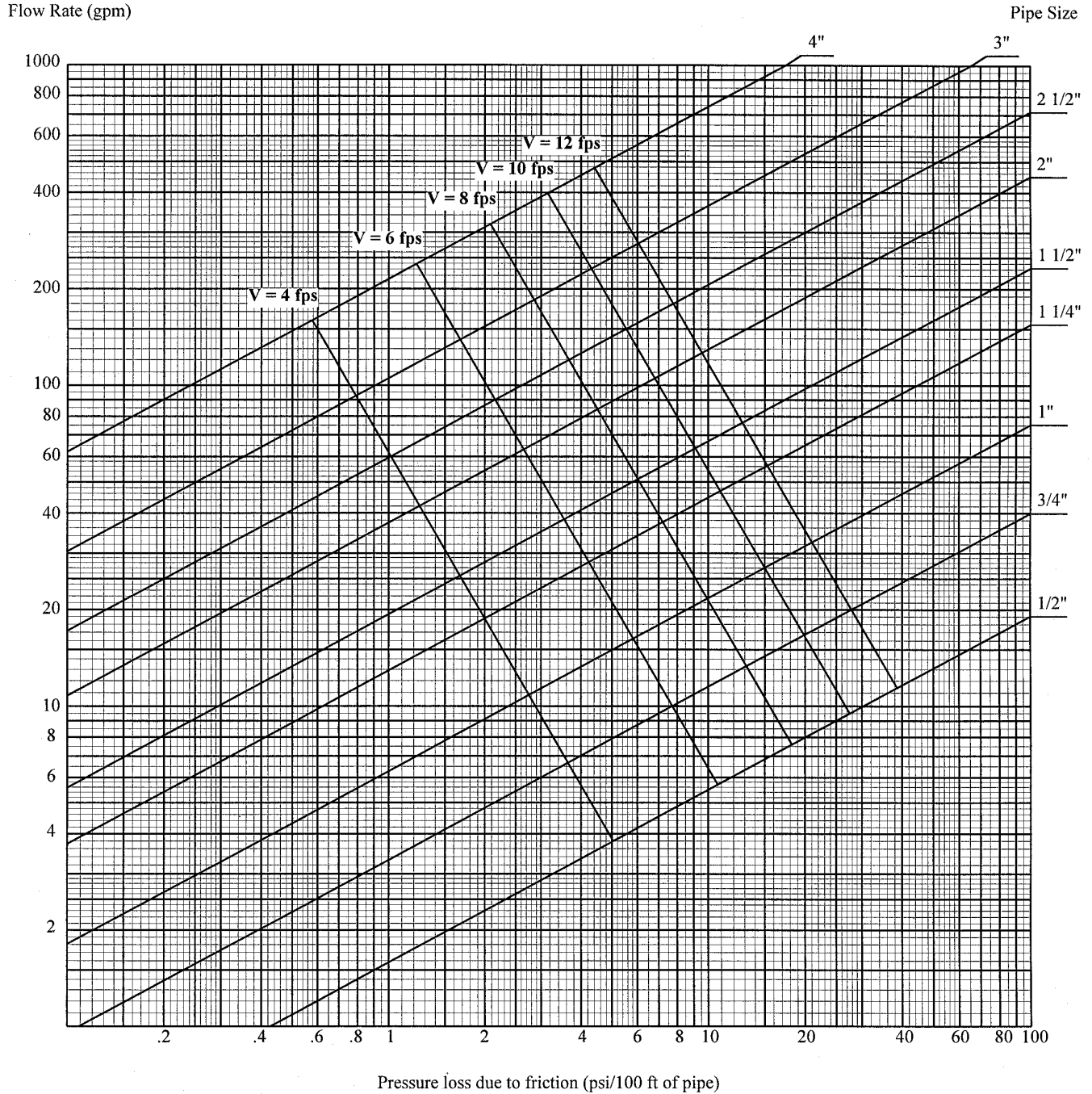

Graph A-82.40 (7)-9
Pressure losses due to flow friction
Material: Copper Tube-Type M, ASTM B88; (C = 150)

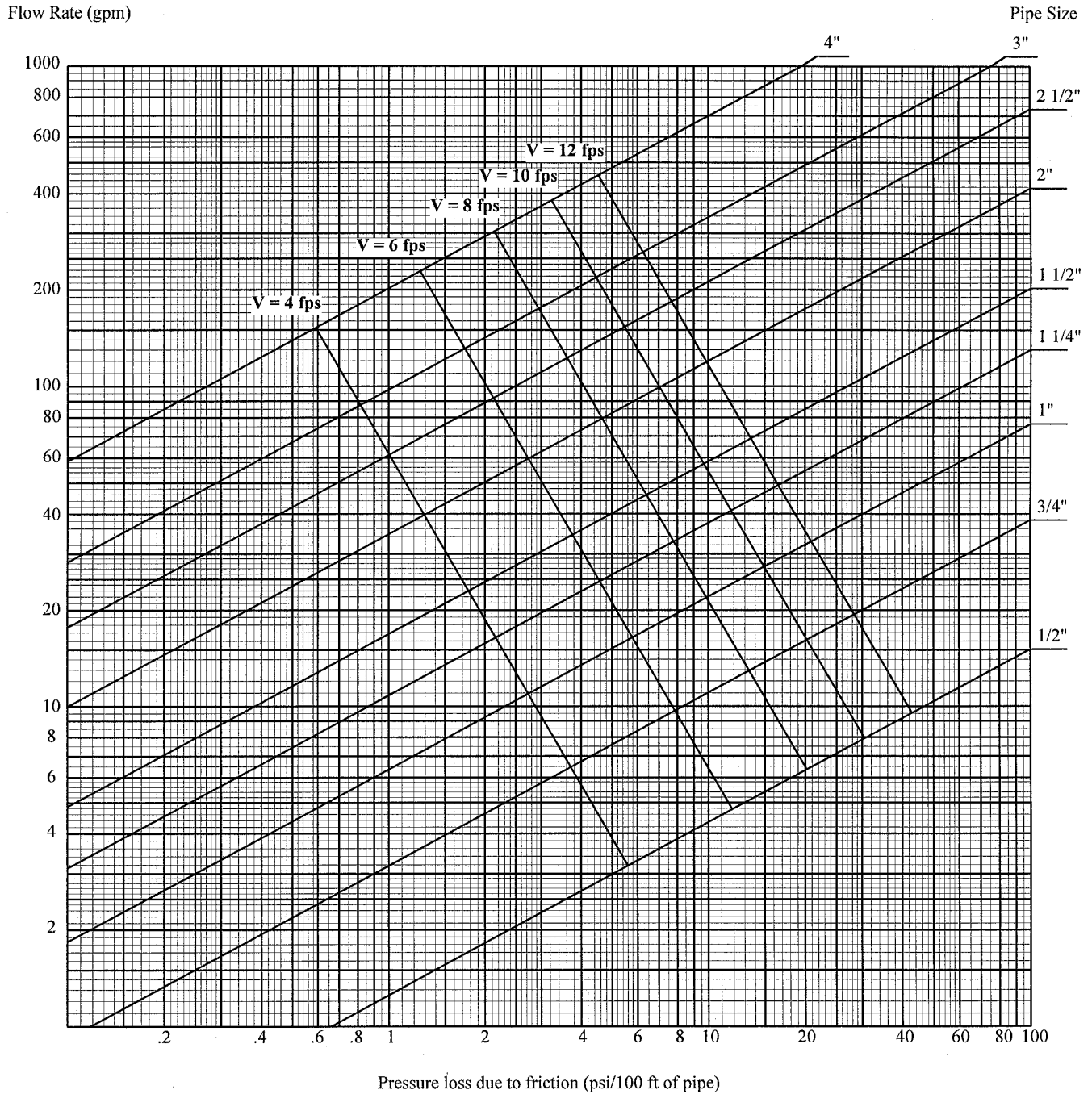

Graph A-82.40 (7)-10

Pressure losses due to flow friction

Material: Polyethylene Aluminum Polyethylene Tubing (PexAlPex), ASTM F1281; (C = 150)

Flow Rate (gpm)

Pipe Size

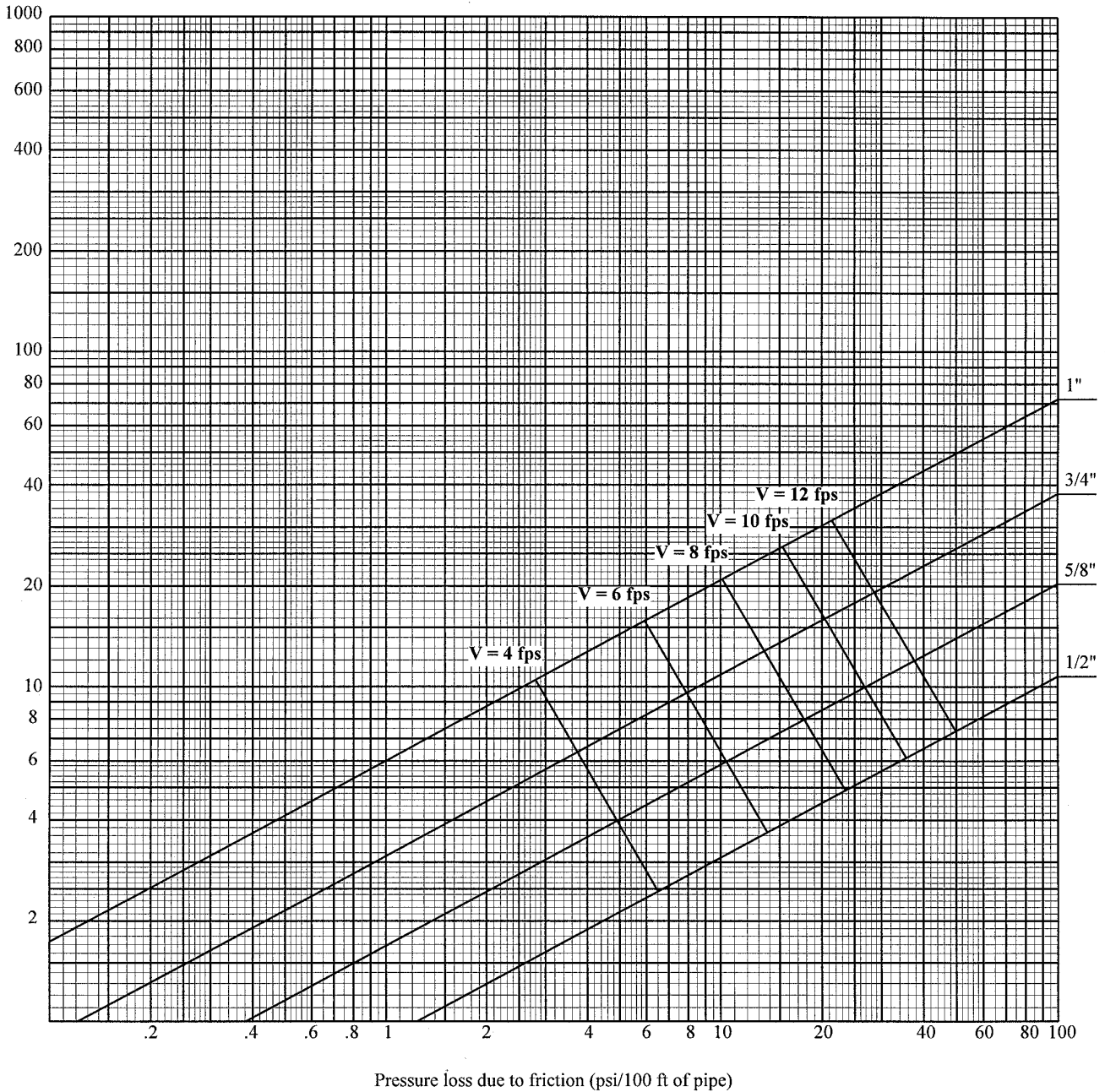

Graph A-82.40 (7)-11
Pressure losses due to flow friction
Material: CPVC Tubing, SDR 13.5; ASTM F442; (C = 150)

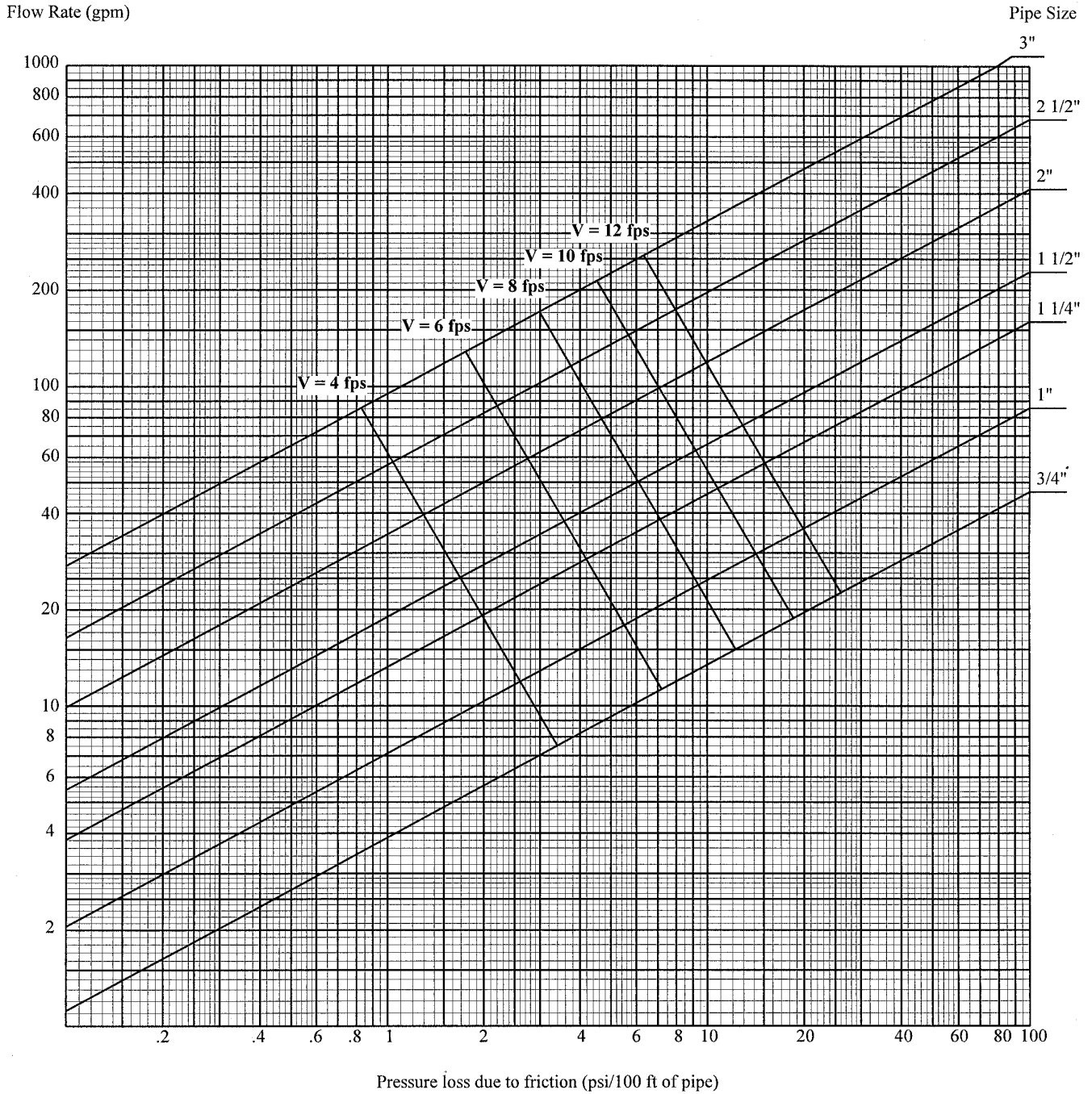

A-82.41 (5) (a) AIR GAP. An air gap for cross connection control for water supply systems conforming to ASME 112.1.2.

Section Comm 81.01 (5) reads: “Air Gap”, water supply system, means the unobstructed vertical distance through the free atmosphere between the lowest opening from any pipe or faucet supplying water to a tank or plumbing fixture and the flood level rim or spill level of the receptacle.’

A pipe/spout which terminates with its outlet above the flood level rim of a receptacle/fixture;

1. Shall terminate a minimum of one inch above the flood level rim of the receptacle/fixture, or
2. Shall terminate a minimum distance of two times the diameter of the effective opening from the end of the pipe/spout to the flood level rim of the receptacle/fixture.

Note: In any case, REGARDLESS of whether the end of the pipe/spout is cut square or at an angle, the air gap is the distance between the lowest end of the pipe/spout and the flood level rim of the receptacle/fixture.

The following water supply air gap, although the least desirable, is acceptable to the ASME 112.1.2 standard.

A pipe/spout(s) which terminate with its outlet(s) completely below the flood level rim of a receptacle/fixture:

1. Must have an opening in the receptacle/fixture which discharges to the atmosphere through an air gap,
2. This air gap must be located as close as possible to the receptacle/fixture,
3. The rate of discharge through this opening as compared to the rate of water entering the receptacle/fixture establishes a “spill level”, which is the level at which water entering the receptacle/fixture seeks a balance and does not raise any higher. (a level is established where the flow of water entering equals the flow of water exiting),
4. The distance then, between this established “spill level” and the end of the lowest water supply pipe/spout is the air gap,
5. The minimum air gap (“Y”) is the distance between the supply pipe/spout(s) and the “spill level” established in the receptacle/fixture,
6. The “spill level” shall be a distance no greater than one half of the distance measured as “Y”, (1/2 “Y”) above the discharge opening in the receptacle/fixture, therefore, the air gap between the supply pipe/spout(s) and the highest portion of the opening which discharges to the atmosphere shall be a distance no greater than one and one half “Y” (1-1/2 “Y”).

Note: In any case, REGARDLESS of whether the end of the pipe/spout(s) is cut square or at an angle, the air gap is the distance between the lowest end of the pipe/spout(s) and the “spill level” of the receptacle/fixture.

However, the measurement for this air gap could be as much as three times the diameter of the pipe/spout(s) depending upon the number of near walls.

The distance of a near wall is a relationship to the diameter of the pipe/spout(s) and the measurement from the wall to the closest side of the pipe/spout(s),

1. If there is one near wall, and the distance between that near wall and the closest edge of the supply pipe/spout(s) is greater than 3 times the diameter of the supply pipe/spout(s), then the minimum air gap is two times the diameter of the supply pipe/spout(s),
2. If there is one near wall, and the distance to the closest edge of the supply pipe/spout(s) is less than three times the diameter of the pipe/spout(s), then the minimum air gap is three times the diameter of the supply pipe/spout(s),
3. If there are two near walls, and the distance between the near wall(s) and closest edge of the supply pipe/spout(s) is greater than four times the diameter of the supply pipe/spout(s), then the minimum air gap is two times the diameter of the supply pipe/spout(s),
4. If there are two near walls, and the distance to the closest edge of the supply pipe/spout(s) is less than four times the diameter of the supply pipe/spout(s), then the minimum air gap is three times the diameter of the supply pipe/spout(s).

It has been determined that near walls of more than two generally have little effect for the need to increase the air gap to more than three times the diameter of the supply pipe/spout(s).

Note: See the following sketches as examples of an air gap with pipe/spouts terminating above the flood level rim of the receptacle/fixture, of an air gap with pipe/spouts terminating below the flood level rim of the receptacle/fixture and of air gap with pipe/spouts when terminating by one near wall.

A-82.41 (5)-1. AIR GAP WITH PIPE/SPOUT(S) ABOVE FLOOD LEVEL RIM OF RECEPTACLE/FIXTURE.

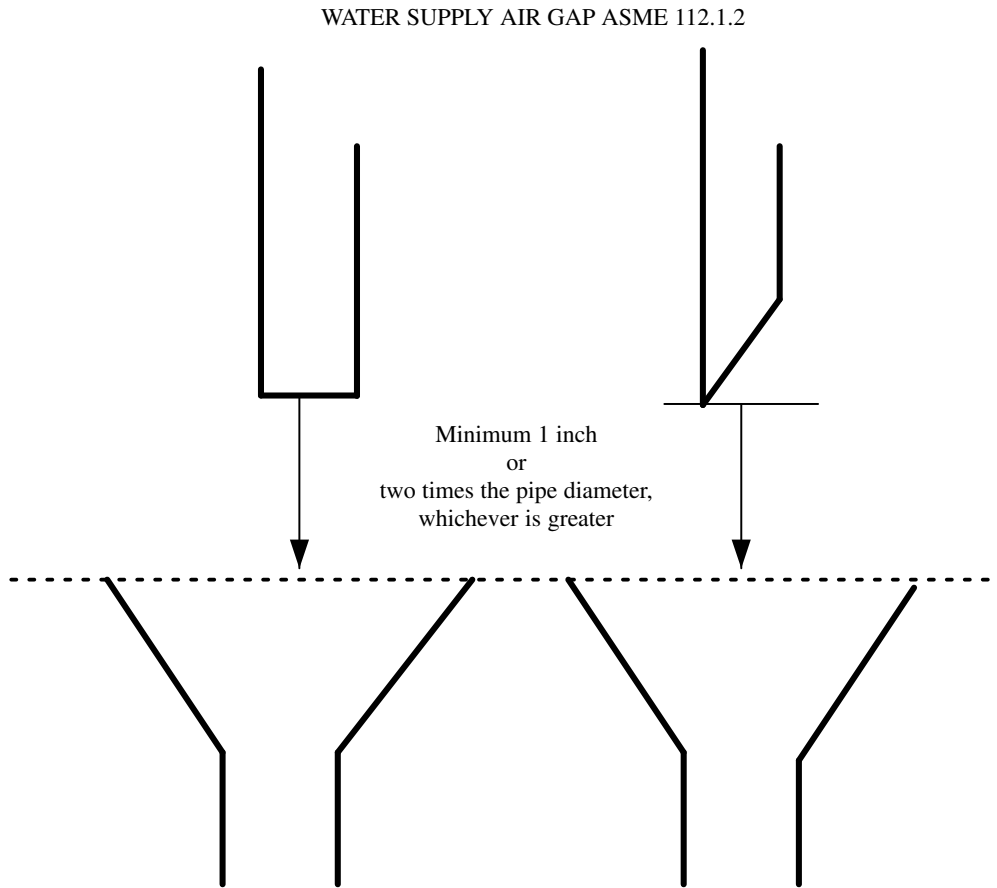

A-82.41(5)-2. AIR GAP WITH PIPE/SPOUT(S) BELOW FLOOD LEVEL RIM OF RECEPTACLE/FIXTURE.

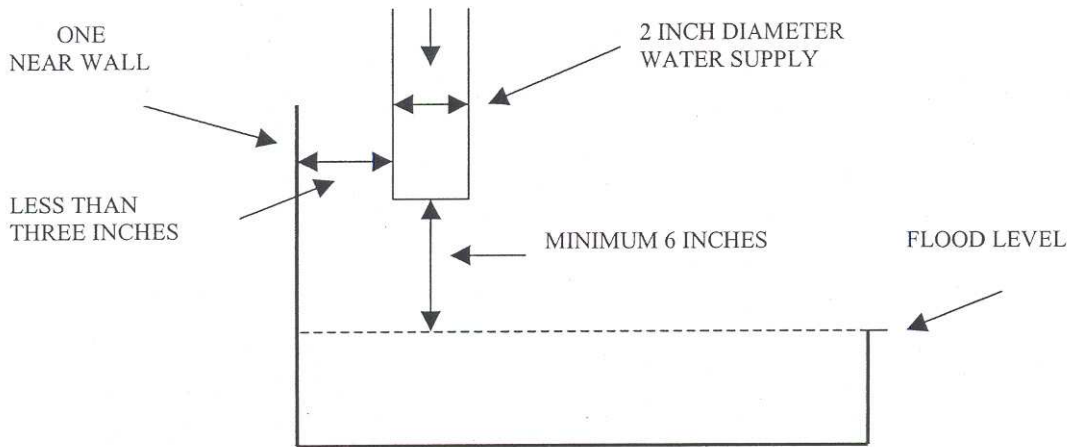
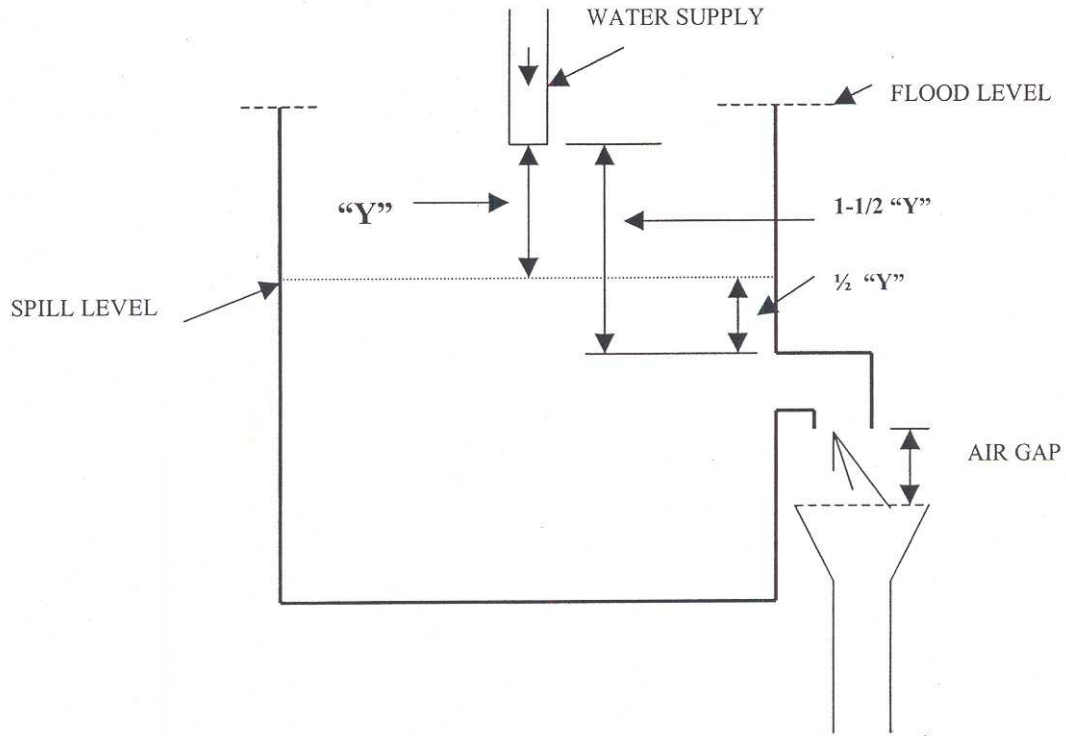

If distance is three times or greater than the diameter of water supply (2 inches) then the air gap is two times the diameter of the water supply, (i.e., $2 \times 2 = 4$ inches)

If the distance is less than three times the diameter of the water supply (2 inches) then the air gap is three times the diameter of the water supply, (i.e., $3 \times 2 = 6$ inches)

A PARTIAL TABLE FOR THE SELECTION OF BACKFLOW PROTECTION *

SITUATION	HAZ-ARD	AIR GAP	ASSE 1001	ASSE 1011	ASSE 1012	ASSE 1013	ASSE 1014	ASSE 1019	ASSE 1020	ASSE 1022	ASSE 1035	ASSE 1052	ASSE 1055	ASSE 1056
Autoclave/sterilizer ¹	Low				X									
Autoclave/sterilizer ²	High					X								X
Boiler	Low				X									
Boiler	High					X								
Building maintenance sink ³	High		X	X		X						X		X
Carbonated beverage dispenser	High									X				
Cappuccino machine	Low				X					X				
Chemical dispensing system ⁴	High	X	X			X							X	X
Commercial dishwasher	High		X			X								X
Commercial clothes washer	High	X	X			X								X
Commercial overhead hose reel	High					X								
Dental unit/chair ⁵	High					X								X
Espresso machine	Low				X					X				
Exterior wall hydrants	High							X						
Food waste grinder	High		X			X								X
Handheld showers	High		X				X							
Hose threaded outlets ⁶	High			X								X		
Humidifier	Low	X			X									
Kidney dialysis machine	High					X								X
Laboratory sink faucet ⁷	High		X								X	X		
Photo developing machine	High					X								X
Proofing oven	Low				X									
Shampoo/barber sink ⁸	High		X			X	X							X
Swimming pools	High	X	X	X		X		X	X			X		X
Therapeutic pools	High	X	X	X		X		X	X					X
Wading pools	High	X	X	X		X		X	X					X
Water cooled compressors	High					X								X
X-ray developing machine	High					X								X
Yard hydrants ⁹	High			X								X		

*Any situation may be subject to an alternate approval.

¹ If less than 15 pounds steam or 30 pounds water, and nontoxic chemicals.

² If greater than 15 pounds steam or 30 pounds water and/or toxic chemicals.

³ Requires backflow protection even if there is a plain end spout.

⁴ Requires separate water supply terminating without a hose thread or the manufacturer must provide a bleed device in order to connect to the janitor sink faucet spout.

⁵ Or, provide bottled water conversion unit.

⁶ For outlets other than the required ASSE 1019 hydrants.

⁷ If provided with hose threads or serrated nipple.

⁸ Faucet meeting ASME A112.18.1M which includes backflow protection requirements.

⁹ Hydrants that bleed into the ground and/or hydrants that are flush with the grade are prohibited.

A-82.41 (5) (f)-1. CROSS CONNECTION CONTROL ASSEMBLY INSTALLATION.

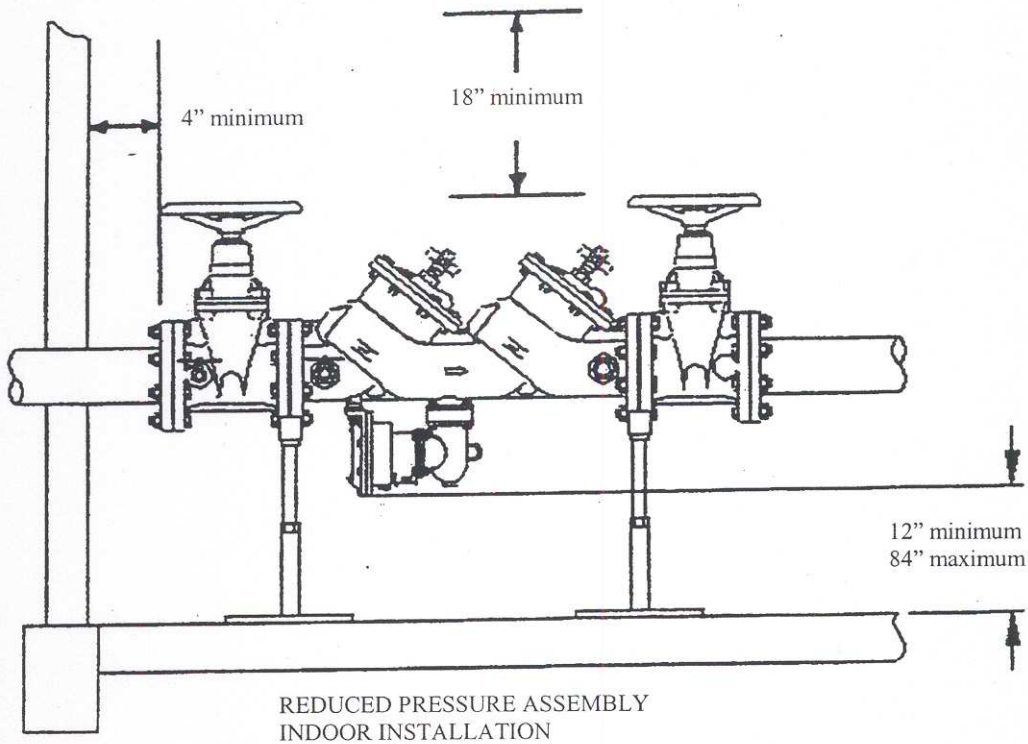
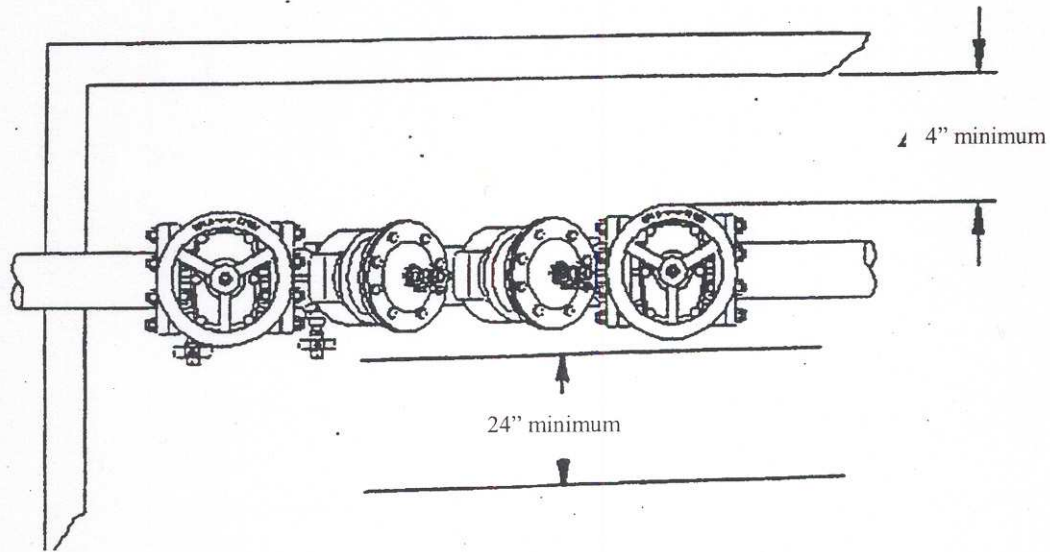

A-82.41 (5) (f)-2. CROSS CONNECTION CONTROL ASSEMBLY INSTALLATION.

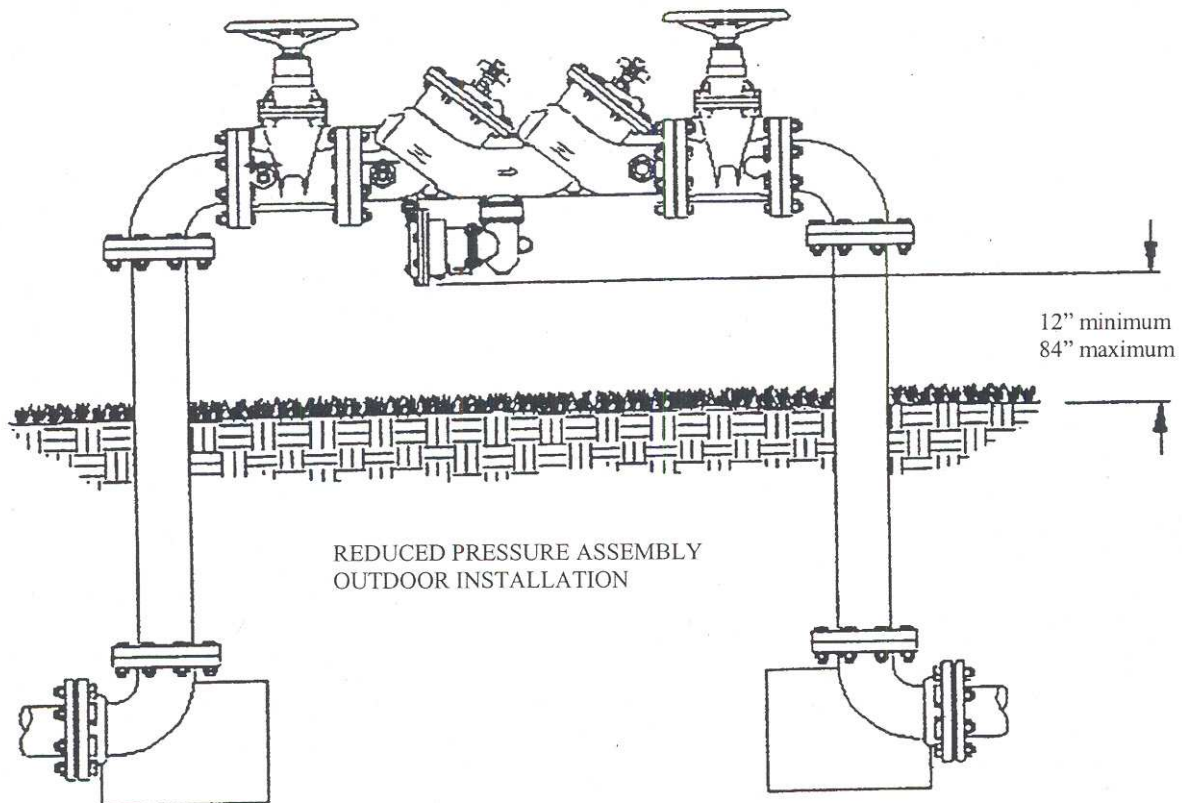
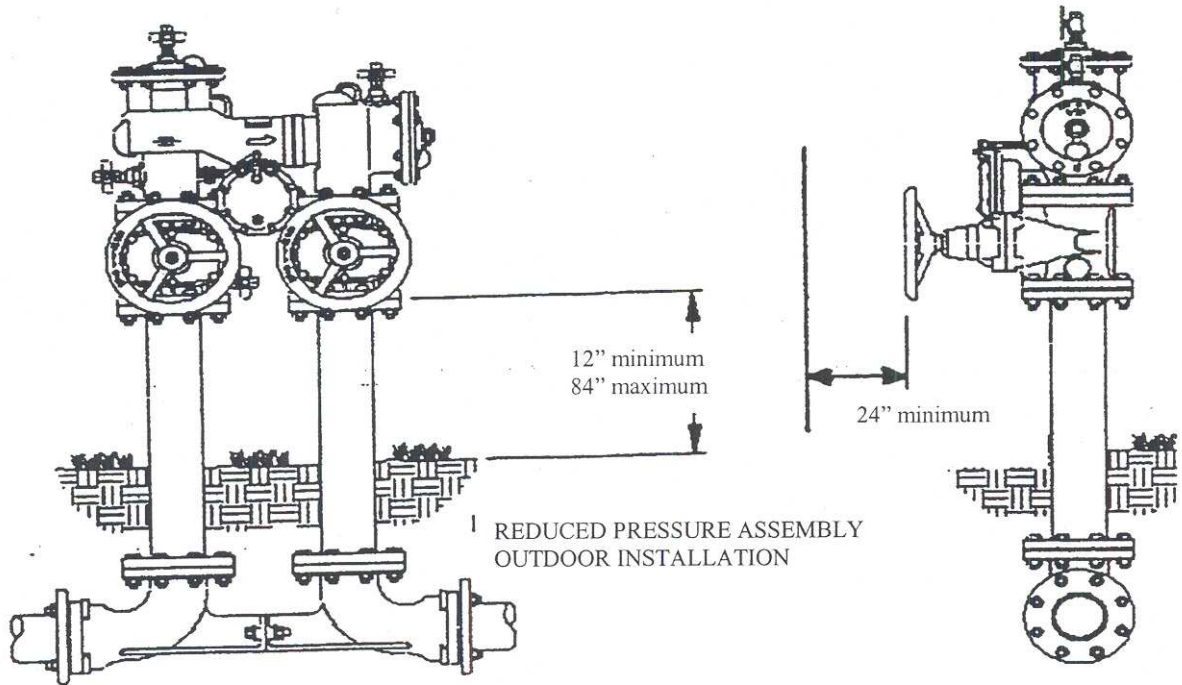

A-82.41 (5) (f)-3. CROSS CONNECTION CONTROL ASSEMBLY INSTALLATION.

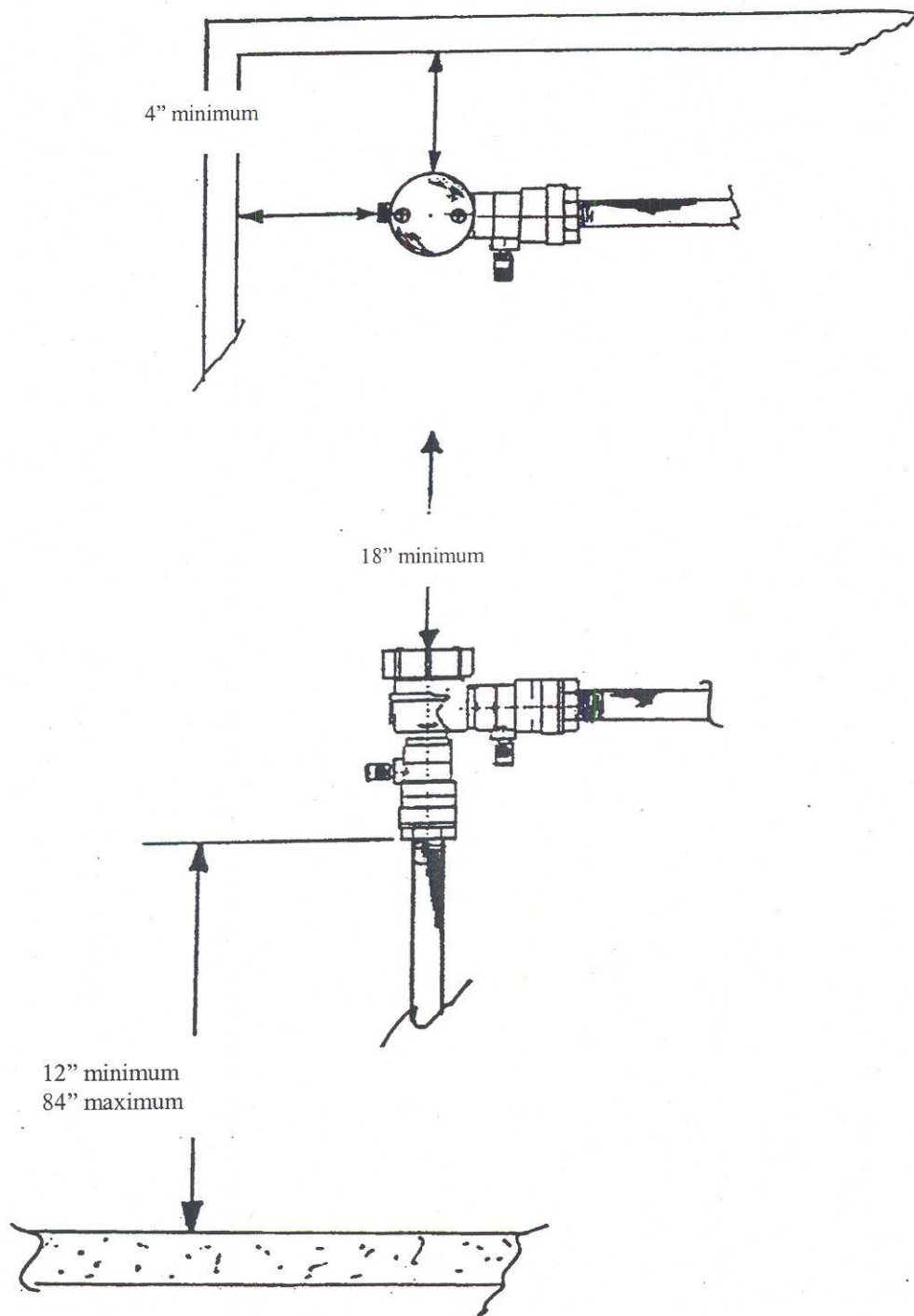

PRESSURE VACUUM BREAKER ASSEMBLY
BACK SIPHONAGE BACKFLOW VACUUM BREAKER

A-82.41 (5) (f)-4. CROSS CONNECTION CONTROL ASSEMBLY INSTALLATION.

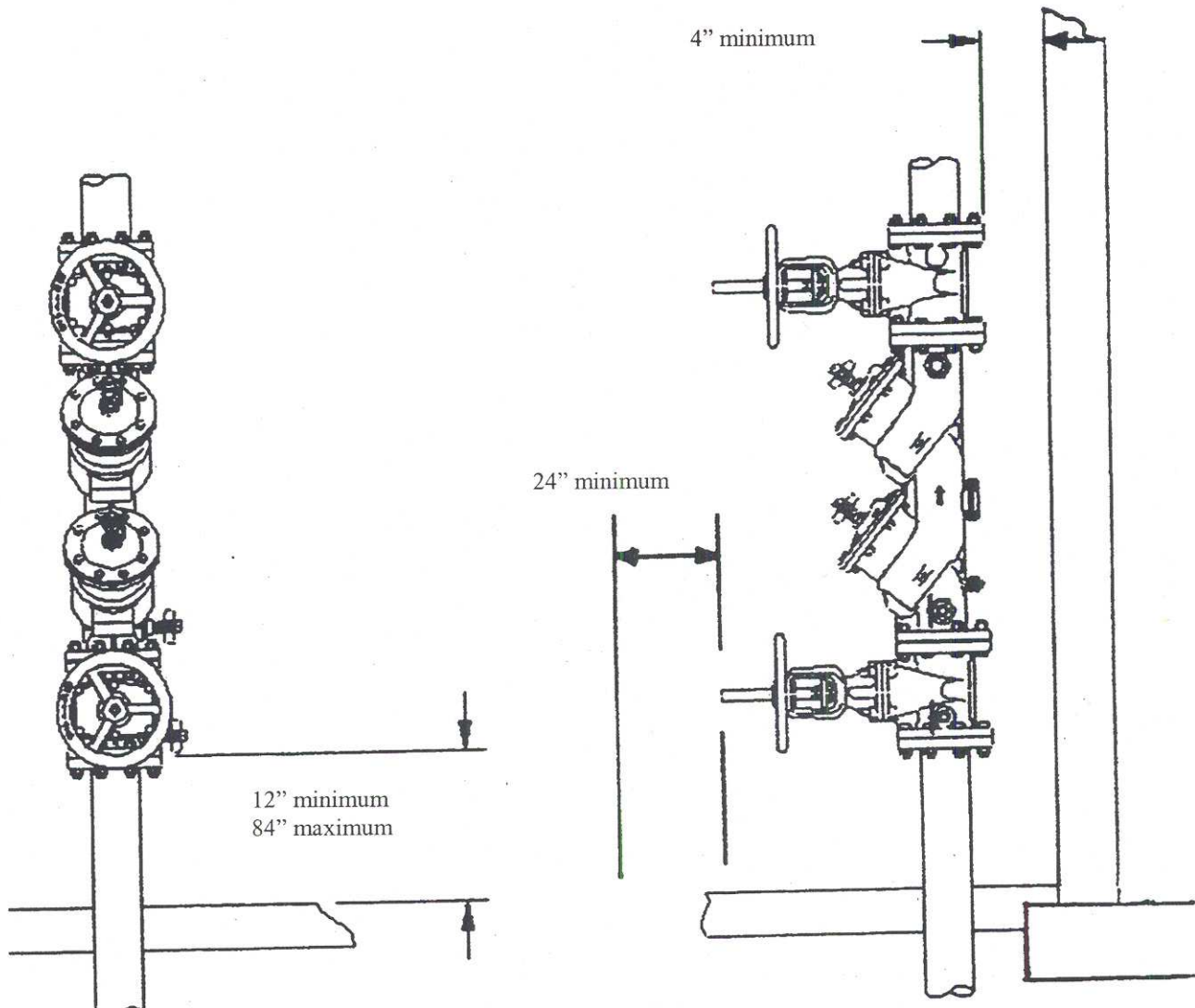

DOUBLE CHECK ASSEMBLY
INDOOR VERTICAL INSTALLATION

A-82.41 (5) (f)-5. CROSS CONNECTION CONTROL ASSEMBLY INSTALLATION.

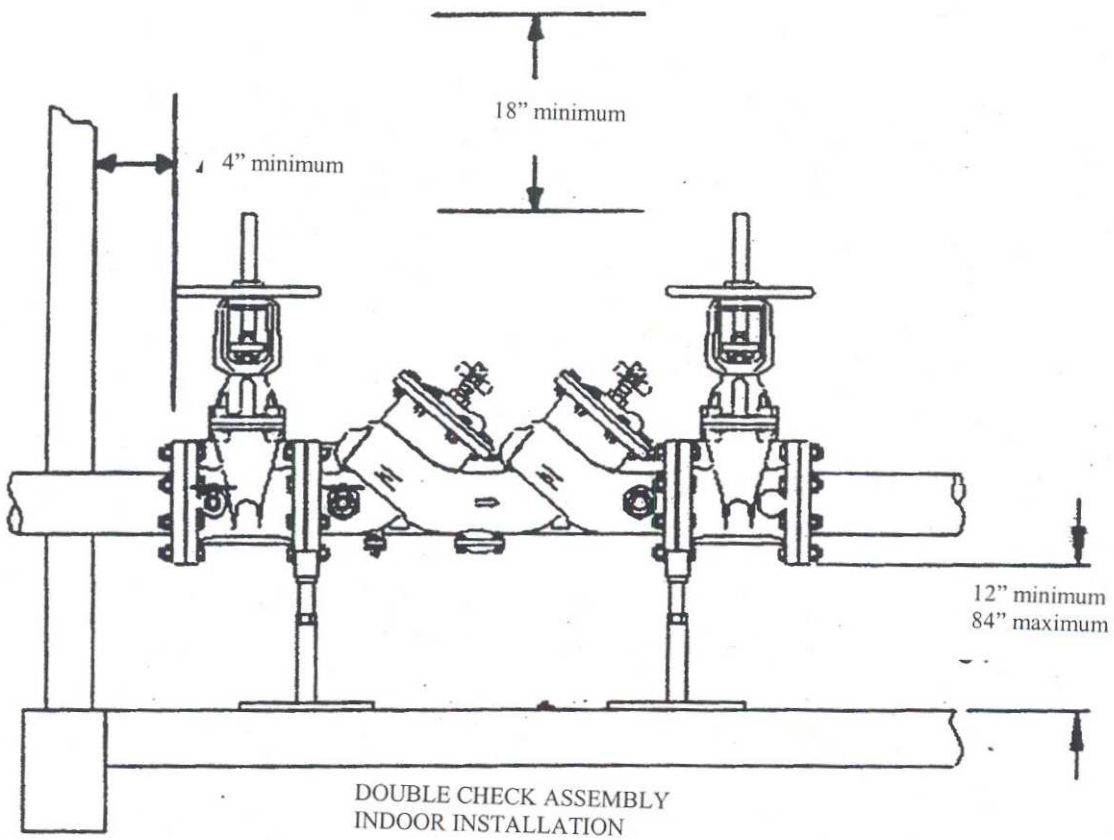
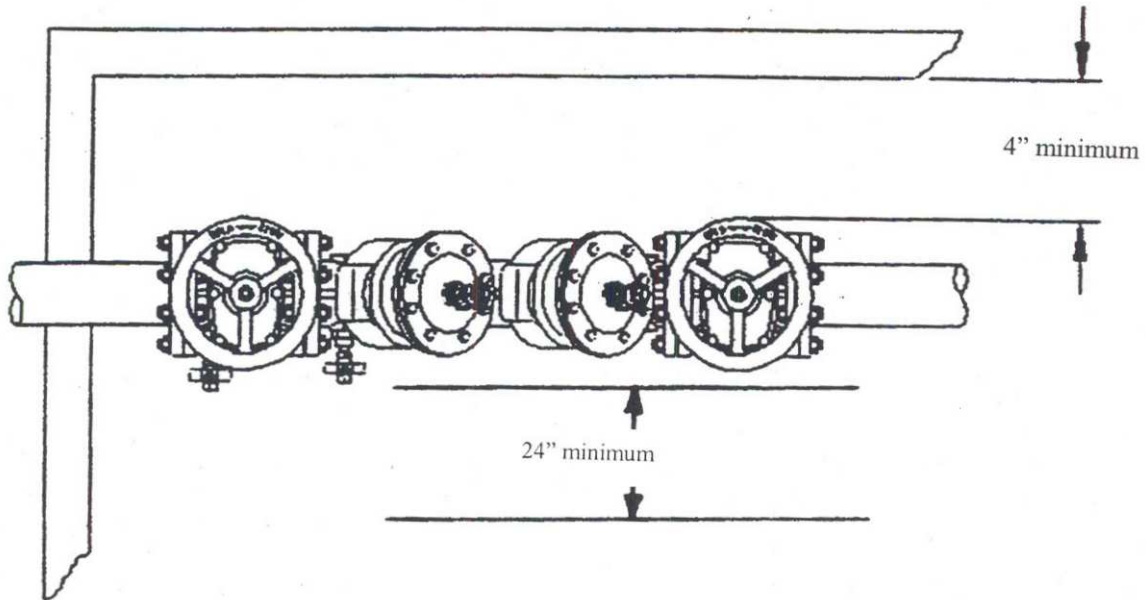

A-82.50 (3) (b) 5. OPTIONS FOR TEMPERATURE CONTROL IN HEALTH CARE FACILITIES. The following sketches provide options for fail safe installations at the bathing and shower fixture and temperature control at handwashing fixtures.

Option 1. Fail safe solenoid provided at main mixer meeting ASSE 1017, pressure balanced tub/shower valve meeting ASSE 1016 and limit stop faucets at lavatory and kitchen sink.

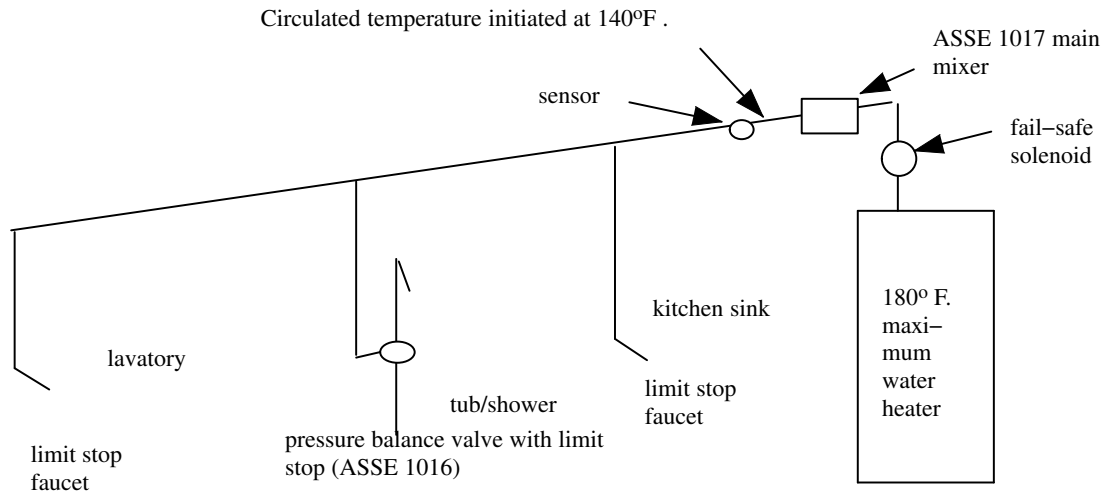

Option 2. Fail safe solenoid provided at main mixer meeting ASSE 1017, pressure balanced tub/shower valve meeting ASSE 1016 and thermostatic mixer meeting ASSE 1016 at lavatory and kitchen sink faucets.

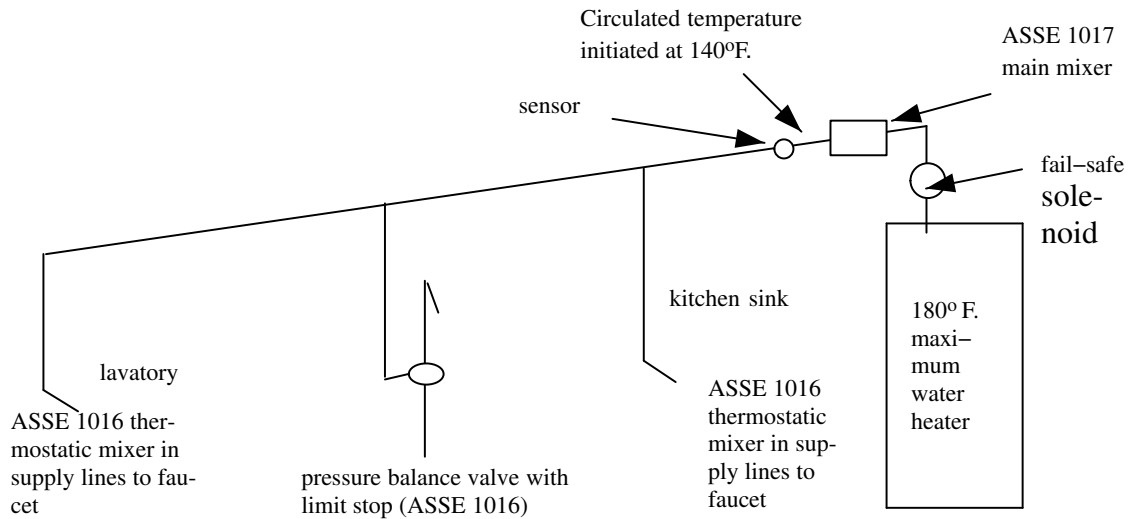

Option 3. Fail safe solenoid provided at main mixer meeting ASSE 1017, thermostatic tub/shower valve meeting ASSE 1016 and limit stop faucets at lavatory and kitchen sink.

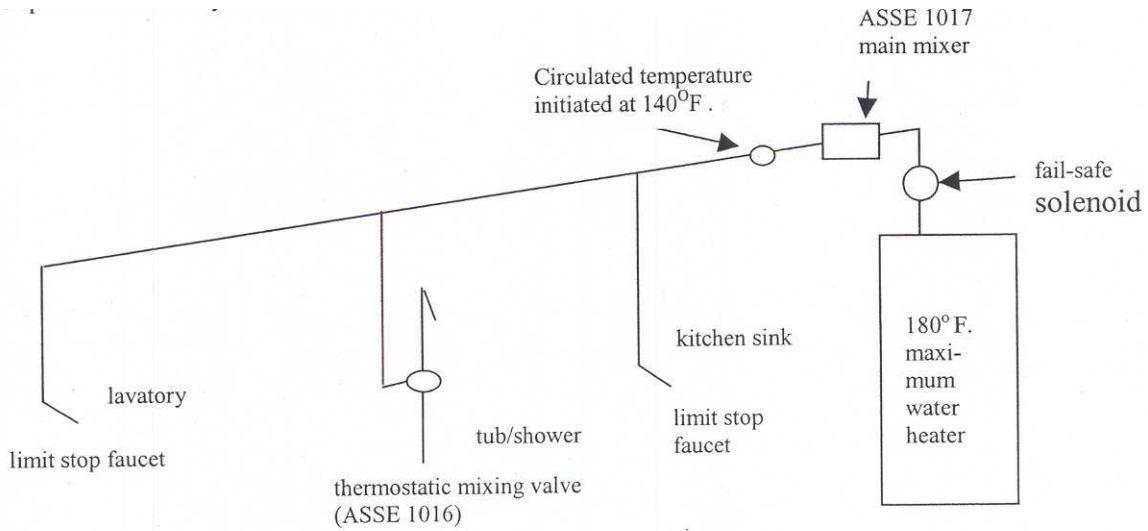

Option 4. Fail safe solenoid provided at main mixer meeting ASSE 1017, combination thermostatic/pressure balance mixing valve meeting ASSE 1016 and limit stop faucets at lavatory and kitchen sink.

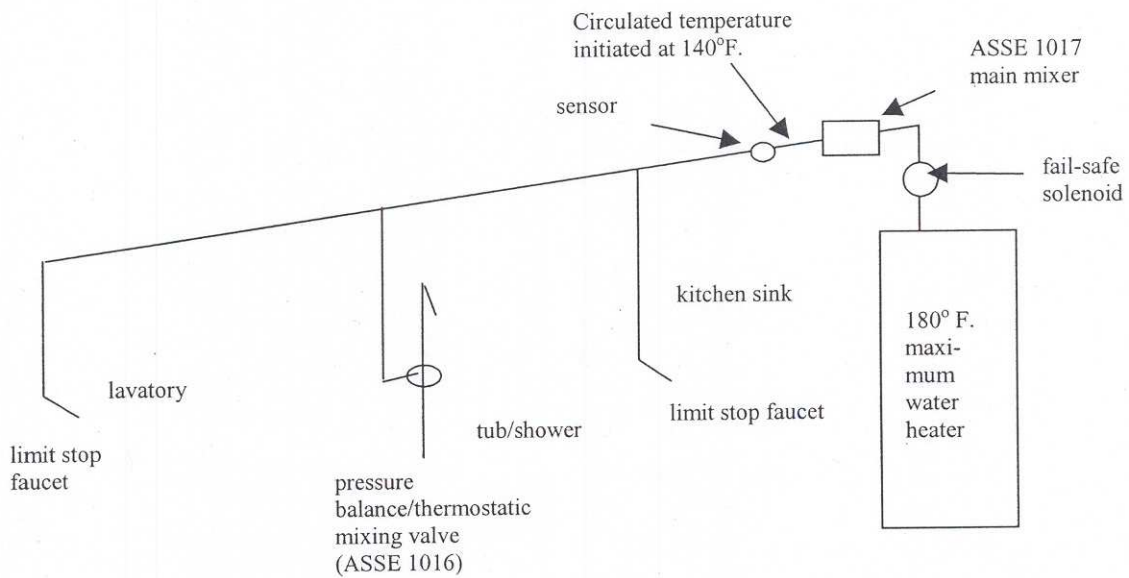

Option 5. Fail safe solenoid, combination pressure balanced/thermostatic tub/shower valve meeting ASSE 1016 and thermostatic mixer meeting ASSE 1016 at lavatory and kitchen sink faucets.

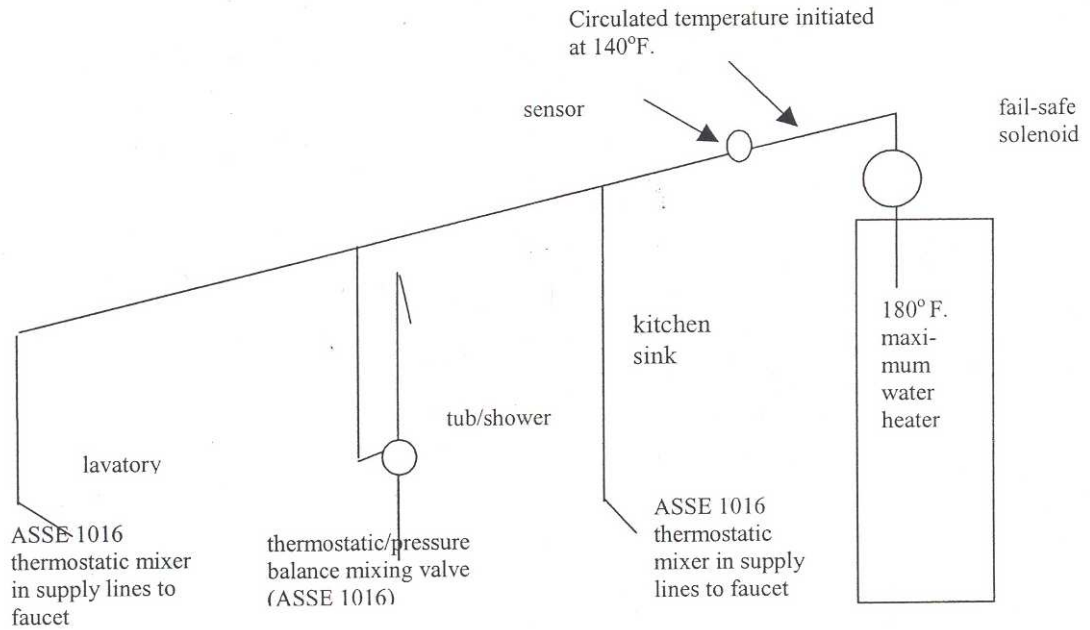

A-82.51 (3) MOBILE HOME SITES AND PARKS. Mobile home building sewer and water service connections.

