

State of Wisconsin \ Department of Commerce

# RULES in FINAL DRAFT FORM

**Rule No.:**

Chapters Comm 90 and 2

---

**Relating to:** Design and Construction of Public Swimming Pools, and Fees

**Clearinghouse Rule No.:** 04-052

COM-10535 (N.03/97)

The Wisconsin Department of Commerce proposes an order to:

**repeal** Comm 90.09 (2) and Not.; Comm 90.16 (2);  
**renumber** Comm 90.09 (3) to (5) as (2) to (4); Comm 90.11 (6) (b) (intro.) as 90.11 (6) (b) 1.; Comm 90.21 as 90.045;  
**renumber and amend** Comm 90.16 (3) as (2);  
**amend** Comm 2.68 (1) and (2); Tables 2.68-1 and 2.68-2; Comm 90 (title); Comm 90.02 (1); Comm 90.04 (intro.), (1) (intro.), (a) 3. and 4., (4) (a), (b), and (e); Comm 90.08 (8) (b) 2. to 4.; Comm 90.09 (2) (b); Comm 90.11 (1) and (8) (a); Comm 90.11 (9) (a) and Note, (b) 8. and (d) 8.; Comm 90.12 (1) (d); Comm 90.13 (6); Comm 90.14 (1) and (2); Comm 90.18 (2) (a); Comm 90.19 (6) (b); Comm 90.19 (9) (g);  
**repeal and recreate** Comm 90.03; Comm 90.04 (4) (c) and (d); Comm 90.04 (6) (c); Comm 90.11 (9) (a) 1. and (b) 9.; Comm 90.13 (1); Comm 90.16 (title) and (1); Comm 90.16 Table 90.16; Comm 90.20; and  
**create** Comm 2.68 (3) (d); Comm 90 Subchapter I to VI (titles); Comm 90.04 (3) (a) 3. b.; Comm 90.04 (6) (a) Note; Comm 90.07 (3); Comm 90.11 (6) (b) 2. and (8) Table 90.11; Comm 90.13 (1); Comm 90.14 (3); Comm 90.16 (2) (k); Comm 90.18 (2) (e); Comm 90.18 (6); Comm 90.20 Tables 90.20-1 to 90.20-5; Comm 90.205 and 90.206, 90.30 and Table 90.30-1, 90.40; relating to the Design and Construction of Public Swimming Pools, and Fees and affecting small business.

\*\*\*\*\*

**ANALYSIS OF PROPOSED RULES**

Statutory authority: ss. 101.19 and 145.26, Stats.  
Statutes interpreted: ss. 101.19 and 145.26, Stats.

The Division of Safety and Buildings within the Department of Commerce is responsible for protecting the health, safety and welfare of the public by establishing reasonable and effective safety standards for the construction, repair and maintenance of public buildings and places of employment. Chapter Comm 90, Design and Construction of Public Swimming Pools, consists of minimum requirements that apply to the design and construction of all new public swimming pools, including whirlpools and water attractions, and to the reconstruction or alteration of any existing public swimming pool.

Section 101.19, Stats., provides the department the authority to fix and collect fees, which shall be as close as possible to the cost of providing the service.

Section 145.26, Stats., provides the department the authority for the establishment of administrative rules; defines public swimming pool and water attraction; provides authority for the department to establish fees for plan review and violations of this chapter. The statutes also require plan submittal and approval prior to any construction, alteration or reconstruction of a public swimming pool.

The proposed rules are created to revise a portion of chapter Comm 90, Design and Construction of Public Swimming Pools, while considering a draft model standard for water parks, ANSI/NSPI-9, Standard for Aquatic Recreation Facilities. This national standard is not being officially adopted by reference, with permission, but was used as a base code, and subsequently modified for use in Wisconsin. The major proposed revisions to chapter Comm 90 relate to the creation of two subchapters:

Subchapter IV—Water Attractions, which includes water parks and other water attractions such as interactive play features, and Subchapter V—Slides, which is being created and expanded to address these common pool features.

Minor changes to the remainder of chapter Comm 90 were made either for consistency with the newly created subchapters, creating rules for slides and other play features installed in pools or water parks, or to reflect provisions in chapters Comm 81 to 87, the state uniform plumbing code and chapters Comm 61 to 65, the state commercial building code.

In addition, section Comm 2.68, Fees, is proposed for minor revisions to fees for associated slides, and plan review and inspection fees for water attractions and water attraction complexes.

The following summarizes by section the more significant revisions proposed in this rule revision.

- Subchapter headings are created to assist in directing users to specific areas of the code. For example, slides are no longer contained within the same section as swimming pools; provisions for water attractions also are now contained in a separate subchapter.
- Section Comm 90.03: With the addition of definitions specific to water attractions and play features, this section has been repealed and recreated. New definitions include: interactive play attraction and specific titles for water attractions to be consistent with NSPI-9.
- Section Comm 90.04: The plan review and approval provisions are being revised to include the requirements for water attractions and slides. Submittal details have been revised to reflect the numerous items common to public swimming pools as well as pool and water attraction complexes.
- Section Comm 90.11: Recirculation and turn over times have been revised to more accurately reflect industry standards and known health-related concerns.
- Sections Comm 90.13 and 90.14: Minor revisions to the construction of public swimming pools are included in this revision. These revisions include performance standards for pool circulation systems and the location of hose bibbs provided for pool maintenance.
- Section Comm 90.16: The layout and materials for dressing areas, shower rooms and toilet facilities have been revised to reflect the state commercial building code, chapters Comm 61 to 65. Revised sanitary fixture counts are proposed to address sanitation needs, particularly in instances where sanitary facilities are already available and accessible. Fixture counts are based on cumulative area of surface water of all pools and water attractions within a complex.
- Section Comm 90.18: For water-conserving measures as well as acknowledging turnover times needed to initially treat water, whirlpools and wading pools may be filled using pool water, providing that water meets standards as specified in section HFS 172.09 (2).

- Sections Comm 90.20, 90.205 and 90.206: A new subchapter is proposed to specifically address water attractions, play features and interactive play attractions. The sections contained in this subchapter are additions and modifications to a draft model standard for water parks, ANSI/NSPI-9, Standard for Aquatic Recreation Facilities. Basic principles of water attraction design are enumerated in this new subchapter; many design parameters allow designers flexibility while providing the necessary health and safety features for the user.
  - Permanently installed play features are being addressed in this rule revision. Design and installation specifications are provided in responding to user safety issues such as entrapment, falls and other safety hazards.
  - Interactive play features, commonly known as splash pads, are being addressed in this rule revision; these include items which may use water for user play. Provisions include water quality and supply, turnover times and recirculation, access points and fencing.
- Section Comm 90.30: Subchapter V is proposed regarding the design, manufacture and installation of all slides installed as appurtenances to public swimming pools or water attractions. Installation parameters are detailed in Table 90.30-1 by slide type; slides are now defined by height, amount of water running through the flume and depth of water at entry.
- Sections Comm 90.40 and 90.405: Subchapter VI, Incorporation of Standards, is created. Two standards are being adopted: ANSI/NSF 50-2001 and ANSI/ASME A112.19.8M-1987 (R1996). Section Comm 90.405 comprises previous section Comm 90.21, Enforcement.
- Appendices: Proposed additions to the appendix include updated information regarding submittals and fees as well as representatives of the department who are authorized to conduct construction inspections as provided in this chapter. In addition, a listing of nationally recognized agencies that are deemed accepted to the department is included. Other items have been added for clarification purposes or reprinting of pertinent sections of chapters Comm 81-87, the state uniform plumbing code.

A comparison of the four neighboring states found that all four states have regulations for public swimming pools. The depth of the regulation is inconsistent however, as Iowa requires only registration whereas Minnesota, Illinois and Michigan require pool plan approval prior to construction. The emphasis of this proposal relates to water attractions (waterslides, splash pads, activity pools, etc.) and Wisconsin's neighboring states have various mechanisms (or lack of mechanisms) for addressing new technology and imaginative designs. Illinois has addressed the design variability of water attraction by allowing individual review for any installation that is not specifically addressed in the code. The Illinois code also has specific language for spray pads (interactive play attractions), slides and lazy rivers (leisure rivers). Michigan has rules for waterslide and pool slide construction and installation, while Minnesota requires an individual approval where the designer must prove a design's compliance with the intent of the code.

An internet search was conducted to review and compare any federal rules or proposed federal rules for "water attractions", "water parks", "water recreation facilities" and "public swimming pools." No Federal rule or proposed rule was found that addresses public swimming pools, water parks or in-pool water attractions or play devices.

An internet search to review and compare any federal rules or proposed federal rules for “pool slides” resulted in the finding of 16CFR, Part 1207, Consumer Product Safety Commission Standards regarding swimming pool slides (revised January 2004). It is found that 75 percent of pool slides are installed in residential pools, not within the scope of this proposal. No Federal rule or proposed rule was found that addresses the manufacture, construction or installation of water slides as they exist in today’s water parks.

The proposed rule revisions were developed with the assistance of the Commerce Pool Advisory Code Council. This council consists of the following individuals:

<u>Name</u>	<u>Representing</u>
Dave Baker	Pool Operators
Bill Branson	City of LaCrosse/Plumbing Inspectors
Tracynda Davis/David St. Jules	Wisconsin Department of Health & Family Services
Duane Jackson	Wisconsin Environmental Health Professionals
Roxanne Johnson	Design Engineers
Julienne Heftner/Tom Carrico	Wisconsin Park & Recreation Association
Daryl Matzke (past chair)	Ramaker & Associates / Pool Designers
Chuck Neuman/Dean Mueller	World Water Park Association
Bill Rollins	Pool Designers
Peter Simon (chair)	Neuman Pools Inc./ Pool Designers
Sean O'Connor	Badger Swim Pools/ Pool Construction Contractors
Doug Voegeli	Madison Dept. of Public Health/Municipal Agents
Jack Waterman	Wisconsin Innkeepers Association

SECTION 1. Comm 2.68 (1) and (2) are amended to read:

**Comm 2.68 Public swimming pool and water attraction plan review and inspection fees. (1)**

Plan examination and inspection fees for public swimming pools ~~and~~, water attractions and associated slides shall accompany plans and specifications when submitted to the department for review. If the department determines, upon review of the plans, that inadequate fees were received, the necessary additional fees shall be received by the department prior to plan review and determination.

(2) Except as provided in sub. (3), plan examination and inspection fees for the construction or modification of public swimming pools ~~and~~, water attractions and associated slides shall be as listed in Tables 2.68-1 and 2.68-2.

SECTION 2a. Comm 2.68 (3) (d) is created to read:

Comm 2.68 (3) (d) *Reinspection fee.* A fee of \$150.00 may be assessed for a second or subsequent final inspection where the initial final inspection is scheduled and partially conducted by the inspector, and the pool installation is found to be incomplete.

SECTION 2b. Comm 2.68 Tables 2.68-1 (title) and 2.68-2 (title) (partial) are amended to read:

**Table 2.68-1**

**Plan Review and Inspection Fees for Public Swimming Pools ~~and~~, Water Attractions and Associated Slides Not Located in Municipalities that Perform Construction Inspections**

Pool Type or Water Attraction	Fee Type		
	Initial Construction	Modification	Revision to Previously Approved Plans
<u>Pool Slide, Drop Slide or Water Slide, functional requirements</u> <sup>a, b</sup>	<u>\$270.00</u>	<u>\$120.00</u>	<u>\$120.00</u>
<u>Pool Slide, Drop Slide or Water Slide, structural requirements</u> <sup>c</sup>	<u>\$300.00</u>	<u>\$120.00</u>	<u>\$120.00</u>
Public Swimming Pool, gutter type	\$900.00	\$500.00	\$120.00
Public Swimming Pool, skimmer type	\$750.00	\$500.00	\$120.00
Water Attraction <u>(including interactive play attractions)</u>	\$900.00	\$500.00	\$120.00
Public Whirlpool	\$750.00	\$500.00	\$120.00
Alternate and Experimental Design	\$1050.00	\$675.00	\$150.00

<sup>a</sup> No additional fee required if submitted with public swimming pool or water attraction.

<sup>b</sup> Fee required per submittal of pool slides or drop slides.

<sup>c</sup> Applies to pool slides over 6 feet (1.8 m) in height measured from the slide entrance to the deck of the pool or water attraction.

**Table 2.68-2 (partial)**  
**Plan Review and Inspection Fees for Public Swimming Pools and Water Attractions and Associated Slides Located in Municipalities that Perform Construction Inspections**

Pool Type or Water Attraction	Fee Type		
	Initial Construction	Modification	Revision to Previously Approved Plans
<u>Pool Slide, Drop Slide or Water Slide, functional requirements</u> <sup>a, b</sup>	<u>\$270.00</u>	<u>\$120.00</u>	<u>\$120.00</u>
<u>Pool Slide, Drop Slide or Water Slide, structural requirements</u> <sup>c</sup>	<u>\$300.00</u>	<u>\$120.00</u>	<u>\$120.00</u>

<sup>a</sup> No additional fee required if submitted with public swimming pool or water attraction.

<sup>b</sup> Fee required per submittal of pool slides or drop slides.

<sup>c</sup> Applies to pool slides over 6 feet (1.8 m) in height measured from the slide entrance to the deck of the pool or water attraction.

SECTION 3. Comm 90 (chapter title) is amended to read:

**Comm 90 DESIGN AND CONSTRUCTION OF PUBLIC SWIMMING POOLS AND WATER ATTRACTIONS**

SECTION 4. Subchapter I (title) is created to read:

**Subchapter I – Administration**

[Note to Revisor: This subchapter title is inserted before s. Comm 90.01.]

SECTION 5. Comm 90.02 (1) is amended to read:

**Comm 90.02 Scope. (1) APPLICABILITY.** This chapter consists of minimum requirements that apply to the design and construction of all new public swimming pools, water attractions and associated slides; and to the reconstruction or alteration of any existing public swimming pool, water attraction and associated slide.

Note: Also refer to administrative rules administered by the department of health and family services, specifically ch. HFS 172, for additional requirements regarding public swimming pools, water attractions and associated slides.

Note: For accessibility information, refer to the final accessibility guidelines for recreational facilities, Federal Register, Vol. 67, No. 170, as published Tuesday, September 3, 2002. Requirements relating to swimming pools, wading pools and spas are found under ADDAG 15.8.



SECTION 6. Comm 90.03 is repealed and recreated to read:

**Comm 90.03 Definitions.** In this chapter:

- (1) “Accessible” means easily and readily exposed for inspection and the replacement of materials or parts with the use of tools.
  - (2) “Approved” means acceptable to the department based on its determination of conformance with this chapter and good public health practices.
  - (3) “Bed and breakfast establishment” has the meaning found in s. 254.61 (1), Stats.  
  
**Note:** Section 254.61 (1), Stats., reads:  
“Bed and breakfast establishment” means any place of lodging that:
    - (a) Provides 8 or fewer rooms for rent to no more than a total of 20 tourists or transients;
    - (b) Provides no meals other than breakfast and provides the breakfast only to renters of the place;
    - (c) Is the owner’s personal residence;
    - (d) Is occupied by the owner at the time of rental;
    - (e) Was originally built and occupied as a single-family residence or, prior to use as a place of lodging, was converted to use and occupied as a single-family residence; and
    - (f) Has had completed, before May 11, 1990, any structural additions to the dimensions of the original structure, including by renovation, except that this limit does not apply to any of the following:
      1. A structural addition, including a renovation, made to a structure after May 11, 1990, within the dimensions of the original structure.
      2. A structural addition, made to a structure that was originally constructed at least 50 years before an initial or renewal application for a permit under s. 254.64 (1) (b) is made and for which no use other than as a bed and breakfast establishment is proposed. The structural addition under this subdivision shall comply with the rules under s. 101.63 (1) and (1m).
- (4) “Breakpoint” means the line of separation between the shallow portion and the deep portion of a pool, defined by a sharp change in the slope of the bottom.
- (5) “Children’s slide” means a slide which has a maximum height of 4 feet (1.2 m) as measured vertically from the slide entrance to the slide terminus and located in  $\leq 24$  inches (61 cm) of water.
- (6) “Deck” means the unobstructed walking surface immediately adjacent to the pool.
- (7) “Deep portion” means the deep side of the breakpoint or that portion of a pool having a design water depth greater than 5 feet (1.52 m).
- (8) “Department” means the department of commerce.
- (9) “Drop slide” means a slide where the terminus is located 20 inches (50.8 cm) or more above the water level.
- (10) “Flume” means that part of a slide within which sliding takes place.
- (11) “Interactive play attraction” means a water attraction, including but not limited to manufactured devices using sprayed, jetted or other water sources contacting the users and not incorporating standing or captured water as part of the user activity area.

**Note:** Splash pads and spray pads are examples of interactive play attractions.

(12) “Mobile pool base” means the location where a mobile pool is stored or serviced and where a source of potable water and a plumbing drainage system are available.

(13) “NSF” means the national sanitation foundation.

(14) “Open swim” means allowing persons, other than those residing in living units, to use the pool or water attraction.

(15) “Owner” or “operator” means a municipality, corporation, company, association, firm, partnership or individual owning, controlling or operating any public swimming pool.

(16) “Patron” means a user of the pool.

(17) “Play feature” means a physical object installed in a pool or water attraction that is intended for recreational use.

(18) “Pool” has the meaning set forth in s. 145.26 (1). Types of pools are as follows:

**Note:** Section 145.26(1) reads: “In this section, “publicswimming pool” means a fixed or mobile structure, basin, chamber or tank and appurtenant buildings and equipment that serve or are installed for use by the state, a political subdivision of the state, a motel, a hotel, a resort, a camp, a club, an association, a housing development, a school, a religious, charitable or youth organization, an educative or rehabilitative facility or another entity. “Publicswimming pool” does not mean a fixed or mobile structure, basin, chamber or tank that only serves fewer than 3 individual residences.”

**Note:** For the purposes of this section, a housing development may mean either an apartment complex, condominium complex or housing complex having a ‘homeowners’ association.

(a) “Combination pool” means a pool used for swimming and diving.

(b) “Diving pool” means a pool used exclusively for diving.

(c) “Exercise pool” means a pool of shallow depth usually associated with a health spa and which may or may not have a current.

(d) “Limited purpose pool” means a pool used for a purpose not otherwise defined, such as for apparatus swimming, underwater photography training or another special use by the public.

(e) “Mobile pool” means a pool constructed on a mobile structure which is capable of being transported from place to place.

(f) “Therapy pool” means a pool used for medically administered therapy.

(g) “Wading pool” means a shallow pool having a maximum depth of 24 inches (61 cm) and intended for children’s play.

**Note:** A zero-depth entry wading pool is an example of a wading pool.

(h) “Whirlpool” means a relatively small pool which uses high temperature water and which may include a water agitation system. A whirlpool may also be referred to as a spa.

(i) “Zero-depth entry pool” means a water attraction having a sloped entrance to where the water depth is zero inches at the shallowest point.

(19) “Pool slide” means a slide where the drop from the slide terminus to water is <20 inches (50.8 cm) and the flume carries less than 100 gpm of water.

(20) “Private guest room” means a room or rooms that provide sleeping accommodation offered for pay to tourists or transients.

(21) “Public swimming pool” has the meaning found in s. 145.26 (1), Stats.

**Note:** Section 145.26 (1), Stats., reads: ““In this section, “publicswimming pool” means a fixed or mobile structure, basin, chamber or tank and appurtenant buildings and equipment that serve or are installed for use by the state, a political subdivision of the state, a motel, a hotel, a resort, a camp, a club, an association, a housing development, a school, a religious, charitable or youth organization, an educative or rehabilitative facility or another entity. “Publicswimming pool” does not mean a fixed or mobile structure, basin, chamber or tank that only serves fewer than 3 individual residences.”

(22) “Recirculation system” means the outlets, inlets, equipment and piping of pools and water attractions designed to circulate water at a predetermined quantity and velocity in order to treat and purify the water.

**Note:** Backwash piping is not part of the recirculation system

(23) “Reconstructed or altered pool” means a pool that requires replacement of or modification to the pool shell, recirculation system and appurtenances so that the pool may continue to be operated free from health or safety hazards. It does not include the replacement of equipment or piping previously approved by the department, provided that the type and size of equipment are not changed, nor does it include normal maintenance or repair.

**Note:** See listing in Appendix A-90.03 (15).

(24) “Reverse flow” means a design in which the water enters at or near the pool bottom and leaves at or near the waterline.

(25) “Run-out slide” means a waterslide where the rider does not enter into a plunge pool, but has a deceleration area that permits the rider to come to a stop before exiting the slide flume.

(26) “Shallow portion” means the shallow side of the breakpoint or that portion of a pool having a design water depth of 5 feet (1.52 m) or less.

(27) “Skimmer” means a device installed in a pool wall at the water level which is connected to the recirculation piping and is intended to skim debris from the surface of a pool.

(28) “Slip-resistant” means a material that when wet has a coefficient of friction greater than 0.5.

(29) “Splash zone” means the area where water falls on the floor of an interactive play attraction.

(30) “Swimming pool complex” means two or more pools as defined under sub. (17) and located within an enclosure or room.

(31) “Swimout” means an underwater seat area that is placed completely outside the perimeter of the pool.

(32) “Terminus section” means the last 10 feet (3.05 m) of a slide flume discharging into a pool.

(33) “Suction outlet” means a discharge port installed in the wall or floor of a pool which connects by way of piping to a pump. A suction outlet does not include a skimmer.

(34) “Tourist rooming house” has the meaning found in s. 254.61 (6), Stats.

**Note:** Section 254.61 (6), Stats., reads: “Tourist rooming house” means any lodging place or tourist cabin or cottage where sleeping accommodations are offered for pay to tourists or transients. “Tourist rooming house” does not include:

- (a) A private boarding or rooming house, ordinarily conducted as such, not accommodating tourists or transients.
- (b) A hotel.
- (c) Bed and breakfast establishments.

(35) “Toxic” has the meaning specified under s. Comm 81.01 (258).

**Note:** Section Comm 81.01 (258) reads: “Toxic” means a probable human oral lethal dose of 15 or less grams of solution per kilogram of body weight.

(36) “Transfer system” means a device or combination of devices that include a platform, steps and other structures or devices to facilitate pool access.

(37) “Turnover time” means the time for a given volume of water to pass through the recirculation system.

(38) “Water attraction” means a public facility with design and operational features that provide patron recreational activity other than conventional swimming and involves partial or total immersion of the body. Types of water attractions are as follows:

(a) “Activity pool” means a water attraction with a depth of greater than 24 inches (61 cm) designed primarily for play activity that uses constructed features and devices including, but not limited to, pad walks, flotation devices and similar attractions. The installation of a basketball hoop or volleyball net does not transform a pool into a water attraction.

(b) “Leisure river” means a stream of near-constant depth in which the water is moved by pumps or other means of propulsion to provide a river-like flow that transports users over a defined path. A leisure river may include play features and devices. A leisure river may also be referred to as a tubing pool or a current channel.

(c) "Plunge pool" means a pool with a depth of greater than 24 inches (61 cm), located at the exit end of a waterslide flume and intended and designed to receive slide users emerging from the flume.

(d) "Vanishing edge pool" means a water attraction that has no above-water line wall on one or more sides and no accompanying deck.

(e) "Vortex pool" means a circular pool that is equipped with a method of transporting water in the pool for the purpose of propelling users at speeds dictated by the velocity of the moving stream.

(f) "Wave pool" means a water attraction designed to simulate breaking or cyclical waves for the purposes of surfing or general play.

(39) "Water attraction complex" means a facility where a water attraction is located within an enclosure or room with another water attraction or public swimming pool.

(40) "Waterslide" means a slide where a water flow of 100 gpm or more is intended to carry a rider down a flume.

SECTION 7. Comm 90.04 (intro.), (1) (intro.) and (a) 3. and 4. are amended to read:

**Comm 90.04 Plan review and approval.** The design for the construction, alteration, or reconstruction of a public swimming pool, ~~or public whirlpool~~ a water attraction or an associated slide, shall be submitted to the department for review in accordance with this section.

Note: The department forms required in this chapter are available on request from the Department of Commerce, Safety and Buildings Division, P.O. Box 7162, Madison, WI 53707-7162; phone (608) 266-3151 and (608) 264-8777 (TTY); or may be downloaded from the Safety and Buildings' web site at [www.commerce.state.wi.us](http://www.commerce.state.wi.us).

Note: For submittal of plumbing plans, see s. Comm 82.20

~~(1) PUBLIC POOL AND PUBLIC WHIRLPOOL REVIEW. A public swimming pool or public whirlpool design~~ All designs under the scope of this chapter shall be submitted to the department for review and receive approval from the department prior to the start of construction or installation.

(a) 3. a. Plans and specifications ~~for all public swimming pools and their equipment,~~ including adequate supporting design data, shall be prepared by a Wisconsin registered architect or professional engineer and bear that person's seal and signature.

4. The department shall review and make a determination on ~~an~~ plan submittal applications under this section application or a public swimming pool or whirlpool submittal within 15 business days of receipt of all information and required fees ~~required for completion of the review.~~

SECTION 8. Comm 90.04 (3) (a) 3. b. is created to read:

**Comm 90.04 (3) (a) 3. b.** Structural review of pool slides shall be based on conformance with the design requirements of slides and tower structures under ch. Comm 62.

SECTION 9. Comm 90.04 (4) (a), (b) and (e) are amended to read:

**Comm 90.04 (4) (a) General.** ~~On~~ The following information shall be included on the plans or in a separate report:

1. The name and address of the owner; ~~and,~~
2. The location of the ~~public swimming pool facility~~ by street address or, if none is available, by quarter-quarter section, section, town, range, township and county.

(b) *Site.* Site information; including, but not limited to, location of all wells and utilities, topography and natural water features.

(e) *Specifications.* Complete technical specifications for the construction of the pool and all appurtenances to accompany the drawings under par. (d), including at least the following:

1. All construction details not shown on the ~~drawings;~~ plans.
2. Detailed requirements for the type, size, operating characteristics and rating of all mechanical and electrical equipment; and,
3. Detailed information about plumbing fixtures and piping, when applicable, ~~such as in bathhouses or when floor drains are used as deck drains;~~
4. The sources of all water supplies, ~~with the total alkalinity, pH and iron and manganese content of the supply indicated on submitted drawings or specifications;~~
5. Filter media such as diatomaceous earth, sand, gravel or other approved material; ~~and,~~
6. ~~Miscellaneous appurtenances.~~ Any other information necessary to determine compliance with this chapter.

SECTION 10. Comm 90.04 (4) (c) and (d) are repealed and recreated to read:

**Comm 90.04 (4) (c) Plot plan.** 1. A general map and detailed scaled drawings showing the site plan or floor plan of pertinent portions of the pool or water attraction structure, pool or water attraction orientation, including the location of all slides, interactive play attractions and play features. The designed pool water elevation shall be shown on the detailed drawing.

2. All water supply facilities, sources of drinking water, public or private sewers and relative elevations of paved or other walkways and the equipment room floor.

3. When public water and sewer systems are proposed to serve the public swimming pool, the elevations of storm and sanitary sewer inverts and street grade.

(d) *Construction plans.* Detailed scaled and dimensional drawings for each individual pool which shall include at least the following:

1. A lay out plan showing longitudinal and transverse cross-sections of the basin. Include location and type of inlets, overflows, pool drains, vacuum fittings, deck drains, drinking fountains or sources of drinking water, piping, hosebibbs, fences, telephones, design of deck, curb or walls enclosing the pool, paved walkways, overflow gutters or devices, ladders, stairs diving boards, slides and underwater lights.
2. A flow diagram showing the location, plan, elevation and isometrics of filters, pumps, chemical feeders, ventilation devices, heaters, surge tanks including operating levels, backflow preventers, valves, piping, flow meters, gauges, thermometers, test cocks, sight glasses and the drainage system for the disposal of pool and filter wastewater.
3. The plan drawings for all available sanitary facilities and any bathhouse facilities provided including dressing rooms, lockers and basket storage, showers and all other plumbing fixtures.
4. The specifications for all pool equipment, floor construction and lighting equipment.
5. The design information used to determine the surface area and volume of the pool or water attraction.

SECTION 11a. Comm 90.04 (6) (a) Note is created to read:

**Comm 90.04 (6) (a) Note:** See Appendix A-90.04 (6)-1 for listing of additional authorized representatives of the department.

SECTION 11b. Comm 90.04 (6) (c) is repealed and recreated to read:

**Comm 90.04 (6) (c)** A final inspection shall be made when the construction or modification is complete.

**Note:** A final inspection, includes, but is not limited to, sanitary facilities, pools, fences and decks.

1. The registered architect, professional engineer or pool contractor constructing or modifying any swimming pool shall make a request for the final inspection.
2. A telephone request for the final inspection shall be made at least 24 hours prior to the requested time for the inspection.

**Note:** Inspections are only available during standard business hours.

SECTION 12. Subchapter II (title) is created to read:

### **Subchapter II – Public Swimming Pools**

[Note to Revisor: Insert This subchapter title before Comm 90.05.]

SECTION 13. Comm 90.07 (3) is created to read:

**Comm 90.07 (3)** The permissible patron load shall be posted in a conspicuous location for viewing by all patrons.

SECTION 14. Comm 90.08 (8) (b) 2. to 4. are amended to read:

**Comm 90.08 (8) (b) 2.** ~~The length of the bench may not exceed 10 feet;~~ the height of the bench may not exceed 18 inches (0.5 m); the width of the bench seat may not exceed 18 inches (0.5 m); the depth of the water above the bench seat may not exceed 2 feet (61 cm).

3. The surface of the bench seat shall be of a color in distinct contrast to the color of the surrounding pool basin or shall have a 2-inch (5.1 cm) leading edge of contrasting color.

4. The words “bench below” shall be placed on the deck at the edge of the pool at the bench area in a contrasting color in distinct contrast to the deck background and at least located at 10-foot (3.05-m) intervals.

SECTION 15a. Comm 90.09 (2) and Note are repealed.

SECTION 15b. Comm 90.09 (3) to (5) renumbered as Comm 90.09 (2) to (4).

SECTION 16. Comm 90.09 (2) (b) is amended to read:

**Comm 90.09 (2) (b) *Outdoor pools.*** The decks of outdoor pools shall slope away from the pool to the ground surface or to deck drains. Deck drains shall discharge either to the storm sewer, with a positive air-gap connection, to the storm sewer so as to provide equivalent protection as determined by the department, or to the ground surface at a point where the water will not create a hazard or nuisance and with a positive air-gap connection if subject to inundation.

**Note:** See Appendix for further explanatory material.

SECTION 17. Comm 90.11 (1) is amended to read:

**Comm 90.11 Recirculation system for a pool. (1) GENERAL.** Each pool shall have a separate recirculation system except that the department may approve the use of a common surge tank. ~~If~~ **When** a room housing the filtration equipment and pool water heater is provided, it shall be well lighted, well ventilated, well drained, and easily accessible for operation and maintenance of equipment. Provision for complete drainage of the recirculation system shall be made. Any connection to a storm sewer or a sanitary sewer shall be through a positive air-gap. All materials covered under ANSI/NSF 50 shall conform to ANSI/NSF 50 or an equivalent standard.



Note: An installation where the backwash is discharged through a manifold systems is not considered to be the interconnection of recirculation systems.

SECTION 18. Comm 90.11 (6) (b) (intro.) is renumbered as Comm 90.11 (6) (b) 1.

SECTION 19. Comm 90.11 (6) (b) 2. is created to read:

**Comm 90.11 (6) (b) 2. a.** Where the outlet piping is located in the bottom of the main drain, there shall be a minimum space of at least one pipe diameter between the outlet pipe termination and the grate.

b. Where the outlet piping is located in the side of the main drain, there shall be a minimum space of at least one pipe diameter between the center line of the outlet pipe termination and the grate.

**Note:** See Appendix for further explanatory material.

SECTION 20. Comm 90.11 (8) (a) is amended to read:

**Comm 90.11 (8) PUMPING EQUIPMENT.** (a) *Recirculation.* The recirculation pump or pumps shall have a capacity that is adequate for circulating the volume of water necessary to provide a complete turnover of diving pool, swimming pool and combination pool water in a 6-hour period. Unless specifically stated in Table 90.11 or elsewhere in this chapter, water turnover ~~rates~~ times for other pools shall be approved by the department. Provision shall be made to ensure that the pump does not become air-bound. Where necessary, self-priming pumps shall be installed. The pump or pumps shall be capable of providing the design flow rates at a total dynamic head of 50 feet (15.25 m) of pressure for all vacuum filters, 70 feet ~~for~~ (21.35 m) of pressure for sand or cartridge filters and 80 feet ~~for~~ (15.25 m) of pressure for diatomaceous earth filters, unless lower or higher heads are shown by the designer to be hydraulically appropriate.

SECTION 21. Comm 90.11 (8) Table 90.11 is created to read:

**Table 90.11  
THERAPY/EXERCISE POOL TURNOVER TIME**

Temperature in °F. (°C.)	Load (gals/person) <sup>a</sup>	Minimum Turnover Time (hours)
72-93 (22-33 °C.)	≥ 2,500	4
72-93 (22-33 °C.)	≥ 450	2
72-93 (22-33 °C.)	< 450	1
>93-104 (>33-40 °C.)	N/A	0.5

N/A = not applicable.

<sup>a</sup>The number of is equal to posted patron load.

**Note:** A therapy area within a multi-section pool having a temperature of ≤ 93 °F. would be considered an activity pool.

SECTION 22. Comm 90.11 (9) (a) 1. and Note, and (b) 8. are amended to read:

**Comm 90.11 (9) FILTRATION.** (a) *General.* 1. A swimming pool water treatment system shall have one or more filters. Filters shall conform to ANSI/NSF standards and 50 or shall be approved by the department. Filters shall be installed with adequate clearance and facilities for easy and safe filter media inspection, maintenance, disassembly and repair.

~~**Note:** The national sanitation foundation's swimming pool equipment standards may be consulted at the department's bureau of integrated services or at the secretary of state's office or the revisor of statutes bureau. Copies may be obtained from the National Sanitation Foundation, NSF Building, P.O. Box 1468, Ann Arbor, Michigan 48106.~~

(b) 8. The backwash water from pressure sand filters, ~~except those serving whirlpools,~~ shall be discharged ~~to a storm sewer through a positive air gap connection or to the ground surface at a point where it will not create a nuisance or health hazard. The backwash water from sand filters serving whirlpools shall be discharged to a sanitary sewer through a positive air gap connection~~ in accordance with Table 82.38-1.

**Note:** See Appendix A-90.20(12)-2 for pertinent sections of ch. Comm 82, Table 82.38-1.

SECTION 23. Comm 90.11 (9) (b) 9. is repealed.

SECTION 24. Comm 90.11 (9) (d) 8. is amended to read:

**Comm 90.11 (9) (d) 8.** Waste water shall be discharged ~~to a sanitary sewer, except that discharge to a storm sewer or the ground surface may be permitted if approved by the department in accordance with Table 82.38-1.~~ The connection to the sewer or discharges to grade shall be by means of the a positive air-gap type where inundation of the outlet is possible.

**Note:** See Appendix A-90.20(12)-2 for pertinent sections of ch. Comm 82, Table 82.38-1.

SECTION 25. Comm 90.12 (1) (d) is amended to read:

**Comm 90.12 (1) (d) Point of addition.** Disinfectant shall be fed into the pool water recirculating system at a point downstream from any heater, ~~except that the department may approve or~~ at another point of introduction based on the feeder manufacturer's recommendations and the resulting residual disinfectant level in the pool water.

SECTION 26. Comm 90.13 (1) is repealed and recreated to read:

**Comm 90.13 Piping for a pool. (1) SIZE.** The size of pool piping, fittings and valves shall be based on all of the following:

(a) The maximum water velocity for pressure piping shall be 10 foot/second (3.05 m/sec.), except for copper piping where the maximum velocity shall not exceed 8 foot/ second (2.44 m/sec.).

(b) The maximum water velocity for suction piping shall be 6 foot/second (1.8 m/sec.) and 1½ foot/second (0.5 m/sec.) flow rate through the suction grates.

(c) Gutter drain lines shall be sized to be capable of continuously removing at least 125% of recirculated water.

SECTION 27. is vacant.

SECTION 28. Comm 90.13 (6) is amended to read:

**Comm 90.13 (6) HOSEBIBBS.** ~~A At least one hosebibb or hosebibbs shall be provided in the equipment room; the dressing, shower and.~~ An additional hosebibb shall be provided in each toilet facility, and at whatever intervals along the deck are necessary so as to permit adequate cleaning using a maximum of 100 feet (30.5 m) of hose. A hosebibb in the equipment room or dressing, shower and toilet facility may be used for deck cleaning if located where a door opens directly to the deck and so that no more than 100 feet (30.5 m) of hose, when laid across the deck surface, is needed to reach the entire all areas of the deck. All hosebibbs ~~served by a potable water supply~~ shall be protected against backsiphonage by proper installation of approved backflow prevention devices, as required in s. Comm 82.41.

SECTION 29. Comm 90.14 (1) and (2) are amended to read:

**Comm 90.14 Pool water heaters and thermometer. (1) INSTALLATION OF HEATERS.** When provided, pool water heaters shall be installed in accordance with ~~s. ss.~~ Comm 84.20 (5) (p) and 84.10 (5).

**(2) THERMOMETER.** A thermometer accurate to within plus or minus 2°F. (1°C.) in the operating range shall be installed in the pool water ~~return~~ recirculation piping ~~where it can be easily read~~

~~to monitor pool temperature and shall be accessible for reading. A means shall be provided for monitoring pool temperature.~~

SECTION 30. Comm 90.14 (3) is created to read:

**Comm 90.14 (3) EQUIPMENT.** Heaters shall be installed and tested in accordance with ch. Comm 64, and either ch. Comm 65 for gas-fueled applications or ch. Comm 16 for electric applications.

SECTION 31 . Comm 90.16 (title) and (1) are repealed and recreated to read:

**Comm 90.16 Dressing areas, showers, toilet facilities and drinking fountains required. (1) GENERAL REQUIREMENTS.** Toilet and handwash facilities, and public drinking fountains shall be located so that they are accessible by a length of paved walking surface no greater than 300 feet (98.4 m) from the nearest rim of the most distant pool. Showers and dressing facilities shall be conveniently located on the premises and accessible by a length of paved walking surface. All applicable building requirements of chs. Comm 61 to 65 shall apply to the construction of indoor pool housing and bathhouses.

**Note:** See Appendix A-90.16 (1) for further information regarding indoor pools.

SECTION 32. Comm 90.16 (2) is repealed.

SECTION 33. Comm 90.16(3) is renumbered (2) and amended to read:

**Comm 90.16 (2) LAYOUT.** (a) *General.* Dressing ~~areas, shower~~ showers, and toilet facilities to be used simultaneously by both sexes shall be divided into ~~2~~ two parts designated by sex and separated by a tight opaque wall. Entrances and exits shall be ~~screened~~ mazed to break line of sight as specified in ch. Comm 62. ~~The facilities shall be laid out so that the patrons on leaving the dressing room en route to the pool pass by the toilets and through the showers.~~

(b) *Floors and drains.* ~~Floors shall be of smooth material that is impervious to water, with a nonslip surface and sloping 1/4 inch (0.64 cm) per foot (0.305 m) toward drains. Floors shall have a smooth, hard, non-absorbent, slip-resistant surface. A smooth, hard, non-absorbent surface shall extend upward on the walls at least 6 inches (15.2 cm). Junctions between walls and floors shall be coved. Drain~~ When floor drains are installed, drain openings shall be 1/2 inch (1.27 cm) or less in width or diameter.

(c) (title) ~~Unroofed~~ Drainage of unroofed areas. Floor drains in unroofed dressing areas shall be connected to a storm sewer or discharged to grade through an air-gap or the floor shall slope to the outer perimeter ground surface.

(d) *Hosebibbs.* Hosebibbs shall be installed in the ~~dressing, shower and toilet areas~~ facility as required in s. Comm 90.13 ~~(5)~~ (6).

(e) *Walls and partitions.* Walls and partitions shall be ~~reasonably smooth and made of durable material~~ have a smooth, hard, nonabsorbant surface to a height of at least 4 feet (122 cm) above the floor, except for structural elements. ~~A~~ Except for structural elements, a space of 10 to 12 inches (25.4 to 30.5 cm) shall be ~~left~~ provided between the floor and the bottom of partitions forming compartments within dressing, shower and toilet rooms.

(f) *Lockers.* Lockers shall be set either on solid masonry bases at least 4 inches (10.2 cm) high or on legs extending at least 10 inches (25.4 cm) above the floor.

(g) *Soap.* A soap dispensing system shall be provided at lavatories and showers serviced by sanitary drains. Dispensers shall be made of durable material and shall be solidly mounted. Glass dispensers may not be used.

(h) *Water heaters.* Water heating equipment of adequate capacity shall supply water at a temperature between 90°F. (32°C.) and ~~110°F. (43°C.)~~ 115°F. (45°C.) to all showers and lavatories. Water heating equipment shall be in accordance with ~~s. Comm 84.20 (5) (p)~~ ch. Comm 84.

Note: Section Comm 82.40(8) (g) requires thermostatic or other temperature control for showers in public buildings.

(i) *Ventilation.* All ~~indoor~~ pool areas, bathhouses, dressing rooms, shower and toilet rooms ~~and toilet rooms~~ shall be adequately ventilated, either by natural or mechanical means, to eliminate the accumulation of condensate and odor.

Note: See also ch. Comm 64, ~~subch. III.~~

(j) (title) *Required number of sanitary fixtures.* The required minimum number of ~~toilet, lavatory and shower fixtures~~ toilets, lavatories, showers and drinking fountains at pools shall be based on the ~~permissible patron load determined under s. Comm 90.07 and on a 1:1 ratio of males to females, except that when pool use is limited to one sex, 100% of the required fixtures shall be provided for persons of that sex.~~ The required number of fixtures shall be as provided in Table 90.16, except that for indoor school pools there shall be one shower for every 3 swimmers in the class with the largest number of students Table 90.16.

Note: Separate toilet facilities should be provided for spectators as specified in chs. Comm 61 to 65. See Appendix A-90.16(1) for further information.

SECTION 34. Comm 90.16 (2) (k) is created to read:

**Comm 90.16 (2) (k) Diaper changing station.** Each restroom shall be equipped with a least one user-accessible diaper changing station.

SECTION 35. Comm 90.16 Table 90.16 is repealed and recreated to read:

**Table 90.16  
MINIMUM NUMBER OF SANITARY FIXTURES REQUIRED AT PUBLIC POOLS AND WATER ATTRACTIONS**

Pool Facility s, Indoor or Outdoor <sup>a</sup> (example of location)	Cumulative Area of Surface Water (in sq. feet )	Number of							
		Public Toilets		Public Urinals	Public Lavatories		Public Showers		Public Drinking Fountains <sup>b</sup>
		F	M	M	F	M	F	M	
1. Swimming pools, wading pools and whirlpools in conjunction with living units having plumbing, except for items 2. to 5. No open swim or lessons permitted. (i.e., apartments, hotels, motels, condos and mobile home parks)	<2000	One unisex		0	One unisex		0	0	1 <sup>a</sup>
	2000 - 7500	1	1	0	1	1	1	1	1
	>7500	See note below for requirements.							
2. Swimming pools, wading pools and whirlpools without living units, except for items 3. to 5.; and swimming pools, wading pools and whirlpools with living units where open swim or lessons are permitted; and water attractions where lessons are conducted. (i.e., municipal pools and campgrounds)	<2000	1	1	0	1	1	1	1	1
	2000 - 3999	3	1	2	1	1	2	2	1
	4000 - 5999	4	2	2	2	2	4	4	1
	6000 - 7499	4	2	2	2	2	5	5	1
	7500 - 8999	8	2	2	3	2	5	5	2
	9,000 - 9,999	10	2	3	4	3	6	6	2
	10,000 -12,999	12	3	3	4	3	6	6	2
	≥ 13,000 - 15,000	14	3	4	5	4	7	7	3
>15,000	See note below for requirements.								
3. Water attractions and water attraction complexes, with living units. No open swim or lessons permitted. Use 300 sq. ft. for slides without basins (i.e., activity pools, waterslide plunge pools, leisure river or tubing pools, and wave pools)	<7500	1	1	0	1	1	1	1	1
	7500 - <10,000	4	1	1	2	2	2	2	2
	10,000 - <15,000	8	2	2	2	2	2	2	2
	15,000 - <22,500	12	3	3	3	3	3	3	3
	22,500 - <30,000	12	3	3	3	3	3	3	3
	30,000 - <37,500	16	4	4	4	4	4	4	4
	≥ 37,500	See note below for design.							
4. Water attractions and water attraction complexes, without living units. No lessons are permitted. Use 300 sq. ft. for slides without basins. (i.e., activity pools, waterslide plunge pools, leisure river or tubing pools, and wave pools)	<7500	2	1	1	1	1	1	1	1
	7500 - <10,000	6	2	1	2	2	2	2	2
	10,000 - <15,000	8	2	2	2	2	2	2	2
	15,000 - <22,500	12	3	3	3	3	3	3	3
	22,500 - <30,000	16	4	4	4	4	4	4	4
	30,000 - <37,500	20	5	5	5	5	5	5	5
	≥ 37,500	See note below for design.							

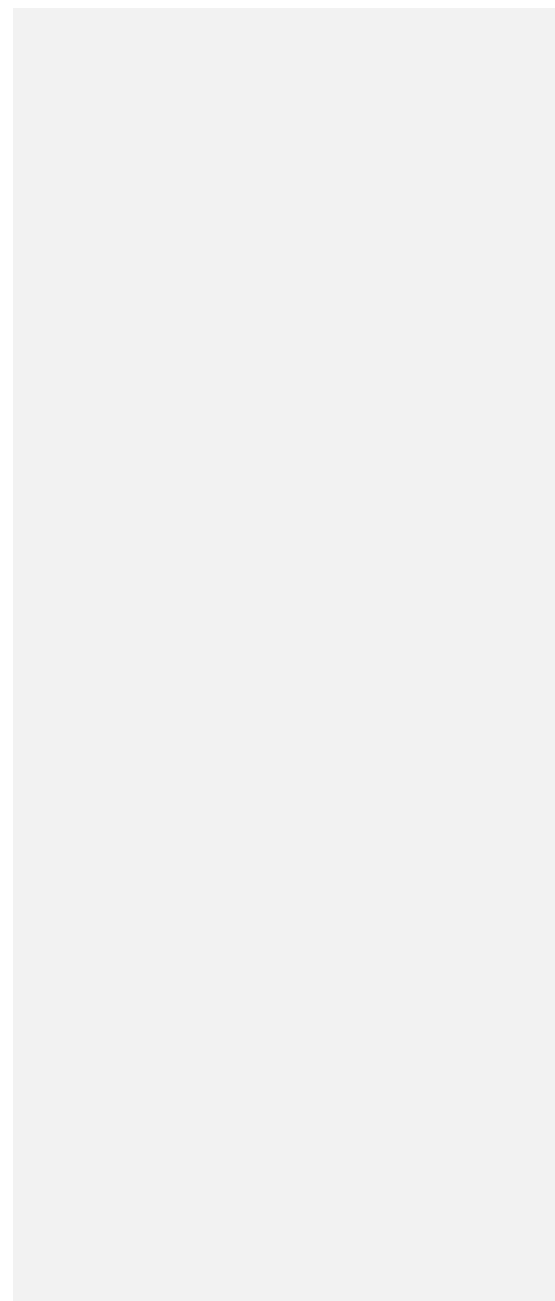

**Table 90.16 (continued)**  
**MINIMUM NUMBER OF SANITARY FIXTURES REQUIRED AT PUBLIC POOLS AND WATER ATTRACTIONS**

Pool Type, Indoor or Outdoor <sup>a</sup> (example of location)	Patron Load	Number of							Public Drinking Fountains <sup>b</sup>
		Public Toilets		Public Urinals	Public Lavatories		Public Showers		
		F	M	M	F	M	F	M	
5. Therapy/Exercise pools.	Up to 10	1	1	0	1	1	1	1	1
	11 – 20	2	1	1	1	1	2	2	1
	21 – 30	2	1	1	2	2	3	3	1
	> 30	Per department approval.							

F = female; M = male; < = less than; > = greater than

<sup>a</sup> For pools with spectator areas, see Appendix A-90.16 (1) regarding chs. Comm 61 to 65 that contain the requirements for sanitary facilities.

<sup>b</sup> Also refer to s. Comm 90.09 (5) for more information regarding source of drinking water.

Notes:

For water attractions in excess of 37,500 sq. ft. use the following additions--

For each 7500 square feet, add one sanitary unit: 0.7 male water closets, 1.0 male urinal, .85 lavatories for males, 1.0 showers for males, 0.6 drinking fountains, 4.0 female water closets, 1.0 lavatories for females and 1.0 showers for females.

For pools in excess of 7,500 sq. ft. and Type 1. above; and for pools in excess of 15,000 sq. ft. and Type 2. above, use the following additions – For each 4,000 square feet, add one sanitary unit: 1.0 male water closets, 1.0 male urinal, 1.0 lavatory for males, 4 showers for males, 4 female water closets, 1.0 lavatory for females, 4 showers for males and 1.0 drinking fountain.

For the requirements listed for additional sanitary facilities, each fraction represents an additional fixture.



SECTION 36. Subchapter III (title) is created to read:

**Subchapter III – Wading Pools and Whirlpools**

[Note to Revisor: This subchapter title is inserted before s. Comm 90.18.]

SECTION 37. Comm 90.18 (2) (a) is amended to read:

**Comm 90.18 (2) DESIGN.** (a) *Turnover time.* The maximum turnover time for wading pools shall be 2 hours. ~~In this subsection, "turnover time" means the time required to completely recirculate all the water in a pool.~~

SECTION 38a. Comm 90.18 (2) (e) is created to read:

**Comm 90.18 (2) (e)** A whirlpool or wading pool may be filled using pool water from an adjacent pool. The water shall meet the requirements as specified under s. HFS 172.09 (2) prior to use.

**Note:** See Appendix A-90.18 (2)-1 and 90.18 (2)-2 for filling options.

SECTION 38b. Comm 90.18 (6) is created to read:

**Comm 90.18 (6) DECKS.** (a) *Deck dimensions.* In addition to the provisions under s. Comm 90.19 (1), a wading pool shall be provided with a minimum of 6 feet (1.8 m) of continuous, unobstructed deck around 50 percent of the wading pool perimeter.

(b) *Deck drainage.* All areas of the deck surrounding a wading pool, including any area between the edge of the wading pool and a wall, shall be constructed to completely drain and easily cleaned. For decks surrounding wading pools that are 20 inches (50.8 cm) or less in width, decks may drain into the wading pool.

SECTION 39a. Comm 90.19 (6) (b) is amended to read:

**Comm 90.19 (6) (b) *Drained and cleanable.*** All areas of the deck surrounding the whirlpool, including any area between the edge of the whirlpool and a wall, shall be constructed to completely drain and be easily cleaned, pursuant to s. ~~Comm 90.09 (2) and~~ sub. (2) (c). Deck areas around a whirlpool that are ~~18 20~~ inches (~~0.5 m~~ 50.8 cm) or less in width may drain into the ~~pool~~ whirlpool.

SECTION 39b. Comm 90.19 (9) (g) is amended to read:

**Comm 90.19 (9) (g) *Equipment room.*** If a room housing the filtration equipment and pool water heater is provided, it shall be large enough to permit easy access to all equipment for both operation and maintenance. ~~A floor drain shall be installed in the room.~~ Whirlpool equipment rooms shall be adequately ventilated and well drained.

SECTION 40. Subchapter IV (title) is created to read:

**Subchapter IV – Water Attractions**

[Note to Revisor: This subchapter title is inserted before s. Comm 90.20.]

SECTION 41. Comm 90.20 is repealed and recreated to read:

**Comm 90.20 Water attractions. (1) GENERAL.** Any new construction or alteration of a water attraction or water attraction complex shall be designed and installed as specified under this subchapter.

**(2) BASIC PRINCIPLES.** (a) *General.* This subchapter is founded upon basic principles of generally accepted engineering practices. Some of the details of design, construction and installation may vary, but the basic engineering principles desirable and necessary to protect the health and safety of pool users and patrons shall be utilized by the department for situations not addressed in this subchapter.

**Note:** This subchapter is a modification of ANSI/NSPI-9, Standard for Aquatic Recreation Facilities (draft), with permission, National Spa and Pool Institute, 2111 Eisenhower Avenue, Alexandria, VA 22314; phone (703) 838-0083; webpage <http://www.nspi.org>.

(b) *Materials.* All water attractions and appurtenances shall be constructed of materials that meet all of the following:

1. In the finished state and application, all materials shall be nontoxic to humans and the environment.
2. All materials shall be impervious and non-abrasive.
3. All materials shall withstand the design stresses so intended.
4. All materials shall provide a watertight structure and have easily cleanable surfaces.

(c) *Structural design.* The structural design and materials used shall be in accordance with generally accepted industry standards and sound engineering practice.

(d) *Protection.* 1. In areas subject to freezing, the pool shell and appurtenances, piping, filter system, pump and motor, and other components shall be designed and constructed to provide protection from damage due to freezing.

2. Provisions shall be made for the relief of stresses which may occur as a result of unbalanced hydrostatic pressures.

(e) *Surfaces.* All surfaces intended to provide patron footing within pool basins shall be slip-resistant.

(f) *Colors and finishes.* 1. Except as provided in subd. 2., all interiors shall be of light colors, patterns and finishes that will not obscure the existence or presence of objects or surfaces within a pool basin.

**Note:** Light in color is defined as having a value of 6.5 or greater on the Munsell color-order system

2. All demarcation lines shall be of contrasting color to the pool interior, but may not be of a thickness or color to obscure the existence or presence of objects or surfaces within the pool basin.

(g) *Diving facilities.* Water attractions which include diving apparatus shall conform with the requirements of s. Comm 90.08.

(h) *Barriers to access.* 1. All water attractions shall be protected by a fence, wall, building, enclosure or solid wall of durable material or any combination thereof.

2. One barrier may surround a pool complex or water attraction complex.

3. For all natural or artificial barriers, the following shall apply:

a. Be constructed so as to afford no external handholds or footholds.

b. Be at least 5 feet (1.5 m) in height and located at least 3 feet (91.4 cm) from any rise in elevation.

c. Be equipped with a self-closing and positive self-latching closure mechanism at a height of at least 45 inches (114 cm) above the ground.

d. Be provided with closure-mechanism hardware for locking and located on the pool side and located at least 3 inches (7.6 cm) below the top of the gate or barrier.

e. The gate or barrier shall have no openings greater than 4 inches (10.2 cm).

4. Alternate means of barriers to access may be provided when approved by the department.

(3) **DIMENSIONAL DESIGN.** (a) *Obstructions.* All water attractions shall be free of protrusions, extensions, means of entanglement or other obstructions that may cause the entrapment or injury of the patron.

1. At no time shall interior basin walls be submerged during operation.

2. All walls in basins shall not exceed 18 inches (0.5m) in width.

(b) *Dimensional tolerances.* All construction deviations from design dimensions shall conform to Table 90.20-1.

**Table 90.20-1  
PERMITTED CONSTRUCTION TOLERANCES FOR WATER ATTRACTIONS**

Design Requirement	Permitted Construction Tolerance (in inches, unless otherwise noted)
Length, overall	±3 (7.6 cm)
Width, overall	±3 (7.6 cm)
Depth, deep area <sup>a, b</sup>	±3 (7.6 cm)
Depth, shallow area <sup>b, c</sup>	±2 (5.1 cm)
Floor nozzle flushness	±1/8 (3 mm)
Stair treads and risers	± ½ (13 mm)
Waterline, pools with adjustable weir skimmers	± ¼ (6 mm)
Waterline, pools with non-adjustable skimming systems (i.e., gutters and zero-depth overflow trenches)	±1/8 (3 mm)
Walls	±3 degrees
Other dimensions not specified above	±2 (5.1 cm)

<sup>a</sup> As measured at a location measured from the pool wall equal to 60% of the nominal pool depth and at the location of the depth marking.

<sup>b</sup> For dimension requirements for diving wells, see s. Comm 90.08.

<sup>c</sup> As measured 3 feet (91.4 cm) from the pool wall at the location of the depth marking.

(c) *Floor slopes.* 1. All pool basins shall slope to the drain or the water evacuation area.

2. For water attractions with water depths less than 5 feet (1.5 m), floor slopes shall not exceed 1:12, except in limited areas where the function of the water attraction requires greater slopes.

3. For water attractions with water depths of 5 feet (1.5 m) or more, floor slopes shall be measured from the point of the first slope change to the point of the deep end and shall not exceed 1:3.

(d) *Wall to floor radius.* Pool walls may be joined to the floor with a tangent radius. For areas of the water attractions having depths of less than 5 feet (1.5 m), the maximum radius shall be 6 inches (15.2 cm).

(e) *Water depths.* 1. The water depth of all water attractions shall be established by the designer or manufacturer in consideration of the function of the pool, except where otherwise required by this chapter.

**Note:** For water depth requirements when a pool slide is installed, refer to s. Comm 90.30.

2. Activity pools having a patron accessible depth greater than 5 feet (1.5 m) shall have a boundary line as specified in s. Comm 90.08 (3).

3. Markings for water depth shall be indicated in feet, inches, or feet and inches and when abbreviated so indicated as “FT” or “IN”. Markings shall be plainly and conspicuously marked on the vertical pool wall, above the waterline where possible, and on the top of the coping or edge of the deck or walk next to the pool.

**Note:** Additional depth markings may also be indicated in metric.

4. When additional markings are indicated in metric, “meters” shall be abbreviated as “M”.

5. a. All depth markers installed on vertical pool walls shall be located so as to be read from the waterside.

b. Depth markers installed on decks shall be located no greater than 18 inches (0.5 m) from the pool edge and positioned so as to be read while standing on the deck facing the water along the effected perimeter.

c. All depth markers installed on horizontal surfaces shall be of slip-resistant materials.

d. Depth markers shall be installed at the maximum and minimum water depths and at all points of slope change as specified in s. Comm 90.08 (3).

e. Depth markers shall be installed around the perimeter of the water attraction at intervals no greater than 25 feet (7.6 m) and at lesser intervals when indicating a change in water depth not to exceed 2 feet (61 cm). Depth markers for irregularly shaped water attractions shall designate depths at all major deviations in depth as well as conform to the provisions in this paragraph.

f. The minimum height of depth marker characters shall be 4 inches (10.2 cm). Characters shall be clearly visible and of permanent contrasting color to the background on which they are applied.

g. Water attractions having depths of 5 feet (1.5 m) or less shall indicate the diving prohibition by markers located on the deck at intervals of no greater than 25 feet (7.6 m).

(f) *Design requirements.* Design requirements as listed in Table 90.20-2 shall be applied to all water attractions under the scope of this subchapter, unless otherwise acceptable to the department.

**Table 90.20-2  
DESIGN REQUIREMENTS BY WATER ATTRACTION TYPE**

Parameter	Water Attraction Type <sup>a</sup>				
	Activity	Leisure River	Plunge	Vortex	Wave
Access entry provisions	Limited by design	Limited by design	Slide only	Limited by design	Beach end
Maximum floor slope	1:12	1:12	1:7	1:12	1:12
Maximum allowed depth	NR	42 in. (1.1 m)	NR	42 in. (1.1 m)	NR

NR = Not Required.

<sup>a</sup> For pools not listed herein, contact the department.

**(4) TURNOVER TIMES.** The maximum turnover times for water attractions subject to this subchapter shall be as listed in Table 90.20-3.

**Note:** For further explanatory information, refer to Appendix A-90.20(3)-1.

**Table 90.20-3**

**MAXIMUM TURNOVER TIME  
BY WATER ATTRACTION TYPE <sup>a</sup>**

<b>Water Attraction Type <sup>b</sup></b>	<b>Turnover Time (in hours) <sup>c</sup></b>
Activity	4
Interactive play attraction	0.5
Leisure river	2
Plunge	1
Runout slide	1
Vortex	1
Wave	2

<sup>a</sup> Calculate an average turnover time for combination vessels.

<sup>b</sup> For pool types not listed herein, contact the department.

<sup>c</sup> Based on flow and pressure drop with a clean filter condition.

**(5) POOL DECK SURFACES AND EQUIPMENT.** (a) *Deck surfaces.* 1. Deck surfaces shall be provided at all perimeter areas of water attractions where specified as entry or exit points.

2. Deck surfaces shall be of non-toxic, natural or man-made, impervious materials.

**Note:** Other regulatory agencies may have more stringent requirements.

3. Decks, ramps, coping and similar step surfaces shall be of materials that are slip-resistant and easily cleanable.

(b) *Deck requirements.* 1. Decks shall be designed and installed in accordance with generally accepted engineering practices.

2. Special features in or on decks such as markers, logos, and brand insignias shall be of materials that are slip-resistant and easily cleanable.

3. a. Stair risers for the deck shall be uniform and have a minimum height of 4 inches (10.2 cm) and a maximum height of 7 inches (17.8 cm). The minimum tread depth shall be 11 inches (27.9 cm). A handrail shall be provided for all stairs having 3 or more risers including the riser to the deck.

b. The height of all handrails shall be located between 30 and 34 inches (76 and 86 cm) above the deck stairs. Handrails shall be located at the outside edge of stairs.

4. a. Except as provided in subpars. b. and c., a minimum usable deck width for any deck provided for public use shall be 6 feet (1.8 m).

b. The unobstructed deck width provided around deck equipment shall be a minimum of 4 feet (1.2 m).

**Note:** For this subdivision, deck equipment includes handrails, structural support columns, lifeguard chairs and play equipment.

c. The unobstructed deck between a water attraction with a basin with a water depth exceeding 24 inches (61 cm) and any wading pool or interactive play attraction shall be a minimum of 12 feet (3.6 m) visible travel length.

5. a. The minimum slope of a pool deck shall be 1/8 inch per foot (1:96) for textured, hand-finished concrete decks and 1/4 inch per foot (1:48) for exposed aggregate concrete decks.

b. Decks shall be sloped to effectively drain either to perimeter areas or deck drains.

6. Except for ramps, the maximum slope of all decks shall be 1/2 inch per foot (1:24).

7. a. The maximum gap between pool decks and other decks or walkways, including joint material, shall be 3/8 inches (9.52 mm) of horizontal clearance with a maximum difference in vertical elevation of 1/4 inch (6 mm).

b. Any gap wider than as specified in subpar. a. shall be filled with suitable caulking material in accordance with the material supplier's specifications.

8. Deck edges that may be contacted by pool patrons shall be radiused, tapered or otherwise relieved to minimize sharpness.

(c) *Concrete decks.* 1. Concrete decks shall be designed and installed in accordance with generally acceptable engineering practices. This provision shall include, but is not limited to, the design and quality of a subbase when required, concrete mix design, reinforcing, and joints.

2. Construction joints where pool coping meets concrete decks shall be watertight.

3. Construction joints where pool coping meets concrete decks shall be installed to protect the coping and its mortar bed from damage as a result of the anticipated movement of adjoining decks.

4. Control joints in concrete decks shall be provided to minimize the potential for cracks due to a change in elevations, separation of surfaces or movement of the slab.

5. The area where pool decks join existing concrete work shall be protected by an expansion joint to protect the pool from the pressures of relative movements.

(d) *Deck equipment.* 1. Testing of circulation system piping shall be performed before the pool deck is poured.

2. Valves installed in or under a pool deck shall be covered and readily accessible for operation, service and maintenance.

3. At least one hosebibb shall be provided in the equipment room. An additional hosebibb shall be provided in each toilet facility, and at intervals along the deck so as to permit adequate cleaning using a maximum of 100 feet (30.5 m) of hose. A hosebibb in the equipment room or dressing, shower and toilet facility may be used for deck cleaning if located where a door opens directly to the deck and so that no more than 100 feet (30.5 m) of hose, when laid across the deck surface, is needed to reach all

areas of the deck. All hosebibs shall be protected against backsiphonage by proper installation of approved backflow prevention devices, as provided in ch. Comm 82.

4. Water-powered devices, such as but not limited to water-powered lifts, shall have a dedicated hose bibb. Hoses for water-powered devices shall be so located so as not to create a tripping hazard.

(6) CIRCULATION SYSTEMS. (a) *System*. 1. a. A circulation system consisting of pumps, piping, return inlets and suction outlets, filters and other necessary equipment shall be provided for complete circulation of water.

b. The circulation system shall be separate for each basin.

**Note:** A manifold discharge pipe connecting backwash piping is not considered an interconnection of the recirculation system

c. Except as provided in subd. d., the circulation system shall not include slide or spray feature circulation.

d. A maximum of 10 percent of the recirculation system rate may be provided for the lubrication of slides or spray features.

2. The equipment shall be designed to turn over the entire pool water capacity as specified in Table 90.20-3. The system shall be designed to give the proper turnover time based on the manufacturer's recommendations regarding maximum pressure and flow of the filter in clean media condition. Water clarity shall be maintained in accordance with par. (d).

3. Circulation system components that require replacement or servicing shall be easily cleanable and readily accessible for inspection, repair or replacement. Circulation system components shall be installed as specified by the manufacturer.

4. Except as provided in subd. 4., circulation systems and equipment within the scope of ANSI/NSF 50, shall conform to ANSI/NSF 50, ETL sanitation listed or the equivalent.

**Note:** For more information on ETL listings, contact Intertek Testing Services (ITS), ETL Sanitation Listed, 8431 Murphy Drive, Middleton, WI 53562; phone: (608) 836-4400; fax: (608) 831-9279; web page: [www.etsenko.com](http://www.etsenko.com)

5. Systems and equipment within the scope of ANSI/NSF 50 shall not be required to bear the NSF endorsement seal if the manufacturer certifies the products are in compliance with ANSI/NSF 50.

6. All circulation system piping shall comply with ANSI/NSF 50 or be of a material suitable for water supply piping as specified in ch. Comm 84. All exposed piping shall be color coded or provided with permanent labels or tags for easy identification.

7. Circulation system piping, other than that integrally included in the manufacture of the pool, shall be subject to an induced static hydraulic pressure test at 50% higher than design operation pressure for a one-hour period, but no less than 25 psi. The test shall be performed before the deck is poured and the pressure shall be maintained through the deck pour.



(b) *Water velocity.* 1. Water velocity in pool piping shall not exceed any of the following applicable velocities:

- a. A maximum of 10 feet/second (3.05 m/sec) for pressure piping, other than copper piping.
- b. A maximum of 8 feet/second (2.44 m/sec) for copper pressure piping.
- c. A maximum of 6 feet/second (1.8 m/sec) for suction piping.
- d. A maximum of 1.5 feet/second (0.4 m/sec) for flow through for suction grates.

2. The circulation system piping and related fittings shall be nontoxic and of material capable to withstand operating temperatures, pressures and conditions.

3. Piping subject to damage by freezing shall be sloped to drain or be installed in such a manner to allow for winterizing.

4. Equipment shall be installed to allow draining.

(c) *Gauges.* 1. All filtration pumps shall be equipped with a vacuum or compound gauge on the suction side of the pump, a pressure gauge located downstream of the pump and upstream of the throttling valve.

2. Flow meters measuring the rate of flow through the filter system with an appropriate range readable in gallons per minute (gpm) and accurate within 10% actual flow shall be provided.

3. Where zones with various turnover times are serviced by a single filtration system, flow meters shall be provided in the supply piping as required at locations to permit monitoring of the flow characteristics to each zone.

**Note:** Pump curves are used to confirm the flow characteristics.

(d) *Filters.* 1. Filters shall comply with s. Comm 90.11 (9) and this paragraph.

2. Filters shall be designed and installed so that filtration surfaces are readily accessible for inspection, repair and replacement.

**(7) PUMPS AND MOTORS.** (a) *Ratings and specifications.* 1. A pump and motor shall be provided for circulation of the pool water. Performance of all pumps shall meet the design conditions of flow required for recirculation and backwashing and all of the following, unless otherwise approved by the department.

a. The pump or pumps shall be capable of providing the design flow rate at a total dynamic head of 50 feet for all vacuum filters.

b. The pump or pumps shall be capable of providing the design flow rate at a total dynamic head of 70 feet for all pressure sand or cartridge filters.

c. The pump or pumps shall be capable of providing the design flow rate at a total dynamic head of 80 feet for all diatomaceous earth filters.

2. All electrical components and installations shall comply with the requirements of article 680 of the National Electrical Code (NEC) as adopted and modified in ch. Comm 16.

(b) *Intake strainers.* For all pressure filter systems, a cleanable strainer or screen shall be provided up stream of the circulation pump.

(c) *Location.* Pumps and motors shall be readily accessible for inspection, repair and replacement as specified by the manufacturer.

(d) *Safety.* The design, construction and installation of the pumps and component parts shall provide safe operation as specified by the manufacturer.

(e) *Mechanical seals.* Where a mechanical pump seal is provided, components of the seal shall be corrosion-resistant and capable of operating under conditions normally encountered in pool operation.

(f) *Design and operation.* All pumps shall be designed by the manufacturer for the intended use.

(g) *Flooded inlet provisions.* Pumps located below the waterline shall have valves installed on suction and discharge lines. Pumps shall be so located for ease in maintenance and removal.

**(8) RETURN INLETS AND SUCTION OUTLETS.** (a) *Performance.* Suction outlets and return inlets shall be provided and so arranged as to produce a uniform circulation of water and maintain uniform distribution of disinfectant throughout the water attraction. The circulation system shall be designed to accommodate 100% of the turnover time.

(b) *Flow distribution.* 1. Suction system flow through the main drain and skimming systems each shall be designed to accommodate 100% of the circulated flow.

2. When multiple systems are used in a single water attraction to meet this requirement, each subsystem shall proportionately comply with par. (a).

3. Suction systems shall be designed with flow rates not exceeding the maximum design flow during normal operation.

4. Except for reverse flow systems, 20 to 25% of the recirculated water shall be drawn through the main drain or drains.

(c) *Inlets.* 1. All water attractions shall have a minimum of two return inlets regardless of water attraction size.

2. a. Basins, other than leisure rivers, shall have the number of return inlets based on at least one additional return inlet per 300 square foot (27.9 m<sup>2</sup>) water surface area, or fraction thereof.

b. Leisure rivers shall have a minimum of one filtered water return point for every 1,000 lineal feet (300.5 m), or fraction thereof.

3. Return inlets shall be sized and located to provide uniform distribution throughout the water attraction.

4. a. Return inlets from the circulation system shall be designed so as not to constitute a hazard to patrons.

b. Bottom returns shall be flush with the basin bottom or designed to prevent injury to patrons.

c. Bottom returns shall be located to have an area of influence described by a radius of 10 feet (3.05 m).

5. a. Wall inlets shall be located to provide uniform distribution throughout the water attraction.

b. One wall inlet shall be located for each 10 feet (3.05 m) of stair well width.

(d) *Grates*. 1. Grates of protective devices for suction outlets shall conform to all of the following:

a. Grates on protective devices shall be designed to withstand the anticipated loading of flow velocity.

b. Grates on protective devices shall be installed as specified by the manufacturer.

2. Drain openings in grates shall be ½ inch (1.27 cm) or less in width or diameter.

(f) *Entrapment avoidance*. The suction outlets shall be designed to protect against a suction entrapment, evisceration and hair entanglement hazard.

(g) *Testing and certification*. Suction outlets, other than skimmers, that measure less than 18 inches by 18 inches (324 sq. in.) (45.7 cm by 45.7 cm) (0.21 m<sup>2</sup>) or do not have at least one dimension that is at least 24 inches (61 cm) shall be provided with covers tested by a nationally recognized testing laboratory to comply with ASME/ANSI A112.19.8M.

(h) *Outlets*. 1. Except as provided in subd. 2., a minimum of two hydraulically -balanced, covered, suction outlets, per pump suction line shall be provided.

2. A single outlet shall be allowed provided the outlet has at least one dimension that is at least 36 inches (91.4 cm).

3. Multiple sets of pump suction pipes shall be allowed to merge into two or more common suction outlets provided the outlets are hydraulically balanced.

4. The distance between the suction fittings shall be at least 3 feet (91.4 cm) if the suction outlets are less than 18 inches by 18 inches (324 sq. in.) (45.7 cm by 45.7 cm) (0.21 m<sup>2</sup>) or do not have at least one dimension that is at least 24 inches (61 cm).

**Note:** See Appendix A-90.20(8) for drain layout details.

5. When dual suction outlets are provided, no piping or valve arrangement may be allowed that will isolate one suction fitting as the sole source of fluid to the pump. The single pipe to a pump suction inlet may be valved to shut off the flow to the pump.

6. a. All grates shall have a maximum grate opening to prevent the passage of a ½ inch (1.27 cm) ball.

b. For wave pools, barriers shall be provided on caissons which prevent the passage of a 4-inch (10.2 cm) ball.

7. Main drain suction outlets shall be installed at the lowest point or points of the water attraction.

(i) *Alternate designs.* Other means, such as vacuum elimination devices, that produce equivalent protection against suction entrapment, evisceration and hair entrapment may be allowed.

**Note:** For additional information, refer to CPSC Guidelines for Entrapment Hazards: Making Pools and Spas Safer, (publication no. 363), U.S. Consumer Product Safety Commission, Office of Information and Public Affairs, Washington, D.C. 20207; webpage: [www.cpsc.gov](http://www.cpsc.gov); e-mail: [info@cpsc.gov](mailto:info@cpsc.gov).

(j) *Vacuum fittings.* The installation and use of vacuum fittings for new construction shall be prohibited.

(k) *Drain provisions.* There shall be a sump with a 6-inch (15.2 cm) minimum depth or a drain at the lowest portion or portions of all water attractions for the purpose of complete draining. The drain grate shall comply with par. (d).

**(9) PERIMETER OVERFLOW SYSTEMS.** (a) *Function.* All basins shall be provided with surface skimming systems and shall be designed and constructed to skim the water surface within the operational parameters of the system's rim or weir device.

(b) *Hazards.* 1. Skimming devices shall be designed and installed so as not to constitute a hazard to patrons.

2. A skimmer cover located on a walking surface shall be securely seated, slip-resistant, of sufficient strength to withstand normal deck use and not constitute a tripping hazard.

(c) *Automatic skimming devices.* 1. Where automatic surface skimming devices are used as the sole overflow system, at least one surface skimming device shall be provided for each 500 sq. foot (45 m<sup>2</sup>) or fraction thereof of the water surface area. Recessed areas such as stairs, swimouts and spas shall not be considered in the calculation. When skimmers are used, they shall be located to maintain effective skimming action.

2. All circulation systems shall be designed to handle 100% of the rated circulation volume through skimmers.

3. The flow rate shall be no less than 3 gpm per skimmer per inch of weir width (11.4 L/min. per 25 mm of weir).

**Note:** The provisions under par. (c) are not intended to apply to constructed weirs.

(d) *Surface skimming.* 1. Acceptable provisions for surface-skimming systems shall be in accordance with Table 90.20-4.

**Table 90.20-4**  
**ACCEPTABLE SURFACE SKIMMING SYSTEMS**

Systems Accepted
Gutters as needed
Flow <sup>a</sup>
Perimeter devices
Skimmers, gutters and other perimeter devices

<sup>a</sup> Water movement in a water attraction moves surface water to a surface skimming point.

2. When gutter skimming systems are used, they shall be connected to a circulation system with an adequate surge capacity to permit all phases of operation.

**(10) ELECTRICAL AND ILLUMINATION REQUIREMENTS.** (a) *Components.* All electrical wiring and equipment shall be installed in compliance with ch. Comm 16.

(b) When operating at night or when open during periods of low natural illumination, artificial lighting shall be provided so that all areas of the pool, including the bottom main drains, are visible

(c) *Emergency illumination.* Water attractions and water attraction complexes that operate during periods of low illumination shall be provided with sufficient emergency lighting to permit safe evacuation of the water attraction and water attraction complex, and securing of the area in the event of a power failure.

**(11) HEATERS.** (a) *Energy sources.* Heating equipment using fossil fuels or alternative energy sources shall comply with chs. Comm 64 and 65.

(b) *Equipment standards.* Heaters shall be installed and tested to comply with the requirements under ch. Comm 65 for gas applications or ch. Comm 16 for electrical applications. Heat pumps shall comply with the requirements under ch. Comm 65 and be accepted by a recognized testing facility. Heaters shall be sized and rated for specific use as specified by the manufacturer.

(c) *Heater installation.* Heaters shall be installed in accordance with s. Comm 90.14.

**(12) WATER SUPPLY.** (a) *Source water quality.* The source water supply serving the pool shall meet the requirements as listed in ch. Comm 82, Table 82.70-1.

**Note:** Refer to Appendix A-90.20(12)-1 for pertinent sections of ch. Comm 82, Table 82.70-1.

(b) *Makeup water quality.* Makeup water to maintain the water level in all water attractions and water used as a vehicle for disinfectants or other pool chemicals, for pump priming or for other such additions shall be as provided in ch. Comm 82, Table 82.70-1.

**Note:** See Appendix A-90.20(12)-1 for approved sources of private water supplies as specified in ch. Comm 82, Table 82.70-1.

(c) *Backflow protection.* Connections to water supply systems shall be as specified in ch. Comm 82.

(d) *Over rim filler.* 1. An over-the-rim spout, if used, shall be located under a diving board, adjacent to a ladder or otherwise properly shielded so as not to create a hazard.

2. The spout open end shall have no sharp edges and shall not protrude more than 2 inches (5.1 cm) beyond the interior wall.

3. The spout shall be separated from the pool water by an air gap at least 6 inches (15.2 cm) or 1.5 pipe diameters from the pipe outlet to the rim, whichever is greater.

(e) *Water level.* 1. All water attractions shall be installed such that the water level is within the specifications of the designer or manufacturer.

2. For zero-depth entry without a surge tank, automatic fill shall be required.

(f) *Pipe labeling.* Pipe shall be labeled in accordance with ch. HFS 172 and Comm 90.13 (5).

**(13) WASTE WATER DISPOSAL.** Pool discharges shall be in accordance with ch. Comm 82, Table 82.38-1 and s. Comm 82.33.

**Note:** See Appendix A-90.20(13)-2 for pertinent sections of ch. Comm 82, Table 82.38-1.

**(14) SANITIZING EQUIPMENT AND CHEMICAL FEEDERS.** (a) *Equipment standards.* 1. Sanitizing equipment shall comply with the requirements of ANSI/NSF 50 or ETL equivalent, and be capable of introducing a sufficient quantity of a sanitizer to maintain the appropriate levels in accordance with ch. HFS 172.

**Note:** For more information on ETL listings, contact Intertek Testing Services (ITS), ETL Sanitation Listed, 8431 Murphy Drive, Middleton, WI 53562; phone: (608) 836-4400; fax: (608) 831-9279; web page: [www.etsenko.com](http://www.etsenko.com)

2. Each water attraction shall include automation equipment to control the sanitizer feed and the pH adjusting chemicals. Such equipment shall be designed and installed to function in compliance ch. HFS 172.

3. Skimmer baskets shall not be used as chemical feeders.

4. Chemical feed pumps shall be wired and installed so that they cannot operate without a return flow to properly disburse the chemical throughout the system as designed.

(b) *Chemical feeder and control systems.* 1. All chemical feed and control systems shall be installed as specified by the manufacturer. The manufacturer's data control plate shall be affixed in compliance with s. Comm 90.12 (1) (e).

2. All chemical feed systems shall be installed so as to only operate when there is return flow to properly disburse the chemical throughout the water attraction as designed.

**(15) SAFETY EQUIPMENT.** (a) *Handholds.* 1. All pools shall be provided with a handhold around their perimeter in areas where depths exceed 5 feet (1.5 m). Handholds shall be provided no farther apart than 3½ feet (9.6 m) to include, but not be limited to, any one or a combination of the items listed in subd. 2.

2. Coping, ledge or deck along the immediate top edge of the pool or a gutter lip immediately below the water level that provides a slip-resistant, flush surface of at least 4 inches (10.2 cm) minimum horizontal width or a raised hand-held edge and located at or not more than 12 inches (30.5 cm) above the waterline, ladders, stairs or seat ledges.

(b) *Safety rope with floats.* 1. For activity pools, a safety rope with floats shall be located to separate pool areas not intended for general swimming, and located at the breakpoint.

2. All safety ropes with floats shall be located no greater than one foot (0.3 m) to the shallow side of the breakpoint.

3. For water attractions with a drop slide or walking pad, all safety ropes with floats shall be located so as not to constitute a safety hazard. This requirement applies to pad walks and slides in plunge pools.

4. A safety rope with floats shall be located in wave pools to restrict access to the caisson wall.

5. When provided, a rope and float line shall be securely fastened to wall anchors of corrosion-resisting materials and of a type that shall be recessed or have no projection that will constitute a hazard when the line is removed.

~~16.3.36.~~ When provided, a rope and float line shall be of sufficient size and strength to provide temporary support and a handhold for the user.

(c) *Emergency shutoff.* Wave pools, vortex pools and leisure rivers shall have a safety stop button located in the proximity of the pool for the purpose of stopping the water action.

**(16) RESTROOM AND SANITARY FACILITIES.** Sanitary facilities shall be provided in accordance with s. Comm 90.16.

**(17) PATRON LOAD.** Patron load for the purpose of operational posting shall be determined the maximum number of patrons for an individual water attraction calculated as 15 square feet (4.5 m) of water surface area for each patron. For the purpose of this requirement, the splash zone of any water attraction shall be included in the calculation of the water surface.

**(18) ENTRIES, EXITS, POOL STAIRS, SWIMOUTS, UNDERWATER BENCHES AND SPECIAL FEATURES.** (a) *Entry and exit locations.* 1. Locations for entry and exit shall be in accordance with Table 90.20-5 or as otherwise acceptable to the department.

**Note:** For accessibility information, refer to the final accessibility guidelines for recreational facilities, Federal Register, Vol. 67, No. 170, as published Tuesday September 3, 2002. Requirements relating to swimming pools, wading pools and spas are found under ADDAG 15.8.

**Note:** Also refer to ch. HFS 172 for pool entrance and exit configurations relating to lifeguard and staffing functions.

**TABLE 90.20-5  
ENTRY AND EXIT LOCATIONS**

<b>Pool Type</b>	<b>Entry and Exit Points</b>
Activity	Ingress/egress at any point in the pool but no greater than 40 feet (12.2 m) from any point.
Leisure river	Minimum of one entry; any number of controlled exits. <sup>a</sup>
Plunge	Entry prohibited from deck areas. Egress by ladders, steps or ramps as determined by designer, but at least a minimum of 50 feet (15.25 m) from any point.
Sand bottom	Ingress/egress in accordance with functional pool classification.
Vortex	Minimum of one entry/exit point.
Wave	Patron access prohibited at all areas except beach end. Side and end wall passage located to accommodate guard needs.
Other pools	Contact the department.

<sup>a</sup> Controlled exits consist of stairs, steps and ladders.

2. Where the distance from the pool floor to the top of the wall is 24 inches (61 cm) or less, such areas shall be considered as providing their own natural entry or exit point.

3. All means of entry or exit shall be provided at the designed ingress and egress points of all pools and may consist of pool stairs, ladder, a ramp or a zero-depth entry.

4. When provided, a secondary means of entry or exit shall consist of one of the following: steps, stairs, ladders with grab rails, treads, ramps, zero-depth entries, swimouts, transfer walls or other designs that provide the minimum utility as specified in this section.

5. When diving facilities are part of the attraction, entries, exits, pool stairs, ladders, underwater benches, special features and other accessories shall be located outside the minimum diving water envelope.

(b) *Zero-depth and sloping pool entries.* 1. All sloping entries used as a pool entrance shall not exceed 1:12 feet (83 mm/m).

2. All sloping entries shall be permitted to be used in conjunction with steps and benches.



3. All zero-depth and sloping entry surfaces shall be of slip-resistant materials to a water depth of at least 18 inches (0.5 m).

(c) *Stairs and ladders.* 1. All treads shall have slip-resistant surfaces.

2. The design and construction of stairs into the shallow end and recessed pool stairs shall conform to the requirements of this paragraph.

3. All risers at the centerline shall have a maximum uniform height of 10 inches (25.4 cm).

4. When stairs are located in a water depth over 4 feet (1.2 m), the lowest tread shall be no less than 4 feet (1.2 m) below the deck.

5. The bottom riser height shall be allowed to vary from the other risers as may be required to meet the floor.

6. The leading edge of all steps shall be distinguished by a color contrasting with the color of the steps and pool floor.

7. Protruding corners shall be rounded to a minimum radius of ½ inch (1.27 cm).

(d) *Handrails.* 1. Handrails shall be located between 30 and 34 inches (76 and 86 cm) above the ramp or step surface.

2. Handrails shall be made of corrosion-resistant materials.

3. Handrails shall be installed so they cannot be removed without the use of tools.

4. The leading edge of handrails or handholds facilitating stairs and pool entry or exit points shall be located on the bottom tread.

5. The outside diameter of handrails shall be a minimum of 1¼ inches (2.8 cm) and not to exceed 1 15/16 inches (4.92 cm).

6. The leading edge of deck-mounted handrails shall be located within 3 inches (7.6 cm) horizontally from the vertical plane of the bottom riser.

(e) *Pool ladder design and construction.* 1. All ladder and staircase treads shall have slip-resistant surfaces.

2. Ladders shall provide two handholds or two handrails.

3. There shall be a clearance of 3 inches (7.6 cm) minimum and 6 inches (15.2 cm) maximum between the pool wall and the ladder.

4. The clear distance between ladder handrails shall be 17 inches (33.2 cm) minimum and 24 inches (61 cm) maximum.

5. There shall be a uniform distance between ladder treads reflecting a 7-inch (17.8 cm) minimum distance and 12-inch (30.5 cm) maximum distance.

6. Ladder treads shall have a minimum horizontal uniform depth of 2 inches (5.1 cm).

(f) *Recessed treads.* 1. All recessed treads shall have slip-resistant surfaces.

2. Recessed treads shall have a uniform vertical spacing of no less than 7 inches (17.8 cm) and no greater than 12 inches (30.5 cm) measured at the centerline.

3. The vertical distance between the pool coping edge, deck or step surface and the uppermost recessed tread shall be 9 inches (22.9 cm) maximum.

4. Recessed treads shall have a depth of no less than 5 inches (12.7 cm) and width of no less than 12 inches (30.5 cm).

5. Recessed treads shall drain into the pool.

6. Recessed treads shall be provided with a handrail, grab rail or handhold on each side of the treads.

**(19) UNDERWATER SEATS, BENCHES AND SWIMOUTS.** (a) *Swimouts.* 1. Swimouts shall be located in a recessed area to eliminate any protrusion beyond the pool wall.

2. The horizontal surface of swimouts shall be no greater than 20 inches (50.8 cm) below the waterline.

3. A minimum unobstructed surface equal to that required for the top tread of the pool stairs shall be provided in the swimout.

4. When used as an entry or exit access, swimouts shall be provided with a step to meet the pool stair requirements.

5. The leading edge of swimouts shall be visually set apart with a marking color to contrast with the swimout.

6. Swimouts shall be allowed in the deep or shallow areas of the pool.

(b) *Underwater seats and benches.* 1. Underwater seats and benches shall be located in a recessed area to eliminate any protrusion beyond the pool wall.

2. The height of any underwater seat or bench may not exceed 18 inches (0.5 m); the width of the bench seat may not exceed 18 inches (0.5 m); the depth of the water above the bench seat may not exceed 2 feet (61 cm) or a 2-inch (5.1 cm) leading edge of contrasting color.

3. The surface of all underwater seats and benches shall be of a color in distinct contrast to the color of the surrounding pool basin or have a 2-inch (5.1 cm) leading edge or contrasting boundary line.

4. The words “bench below” shall be placed on the deck at the edge of the pool at the bench area in a color in distinct contrast to the deck background.

5. Underwater seats and benches shall not be used as a required access entry or exit point.

6. Underwater seats shall not be located in deep area of the pool where diving equipment is installed.

7. Underwater seats and benches are allowed in conjunction with pool stairs.

SECTION 43. Comm 90.205 is created to read:

**Comm 90.205 Play features. (1) GENERAL.** (a) Structures and devices not intended for patron contact such as climbing, walking and hanging shall be either designed or supervised to prevent such contact.

(b) Rafts, tubes, noodles and other personal use devices shall not be subject to this section.

**Note:** For obstructions in wading pools, refer to s. Comm 90.18.

**(2) IN-WATER PLAY FEATURES.** (a) In-water play features permanently installed shall be subject to this subsection.

**Note:** Examples of in-water play features include, but are not limited to, floating boats and trucks, floatable walks, floatables, spray pad features not in conjunction with a pool or water attraction with a recirculation system and other permanently installed features.

(b) 1. Floating features may not be installed in pools with water depths of less than 36 inches (91.4 cm).

2. Except as provided in subd. 3., a minimum 3 feet (91.4 cm) of water depth shall be maintained at least 6 feet (1.8 m) from any tethered play feature.

3. A tethered play feature may be located at least 6 feet (1.8 m) of a wall when that portion of the wall is padded to a point 6 feet (1.8 m) from the play feature.

**Note:** Padding need only cover the wall above the waterline.

(c) Floating play features shall be anchored in such a manner to restrict their movement to a range as established by the designer.

(d) The means of anchoring of tethered play features shall be configured in such a manner as to minimize circumstances of possible entrapment of patrons, bodies, hair, limbs or appendages when in contact with any element of the play feature or its anchors.

**Note:** The use of jacketed chains or cables meets this requirement.

(e) All in-water play features shall be designed and installed to prevent injury to the user and constructed so as not to create a safety hazard.

(f) 1. When more than one pad walk is located in the same pool basin, a minimum separation of 10 feet (3.05 m) between pad walks shall be provided.

2. All deck or basin obstructions within 4 feet (1.2 m) of a pad walk shall be padded or encased so as to protect pool patrons from abrasion, laceration or contusion.

(g) A minimum separation of 10 feet (3.05 m) between two floatables, other than two pads within a pad walk, shall be provided.

**(3) ON-DECK PLAY FEATURES.** Play features permanently installed on decks shall be designed and installed to prevent injury to the user and constructed so as not to create a safety hazard.

**Note:** Examples of on-deck play features include basketball hoops, volleyball nets and other water games.

SECTION 44. Comm 90.206 is created to read:

**Comm 90.206 Interactive play attractions. (1) GENERAL.** Interactive play attractions may be included with pool complexes, water attraction complexes, or as a single water attraction.

**Note:** When an interactive play attraction is added to a single pool, the facility becomes a water attraction complex as specified in s. Comm 90.20.

**(2) DESIGN AND MATERIALS.** (a) The structural design and materials used shall be in accordance with generally accepted industry practice. All parts of an interactive play attraction shall be designed and constructed so as to not pose a safety hazard.

(b) All materials for walking surfaces shall be slip-resistant.

(c) 1. The splash zone shall be sloped to drain to the surge tank or pool within the same basin.

2. The maximum floor slope to drain of the splash zone shall be 1:12.

3. All exterior walking surfaces shall be sloped to drain away from the splash zone.

4. The minimum floor slope shall be 1/8 inch per foot.

(d) A minimum deck separation of 12 feet (3.6 m) shall be provided between basins with water depths greater than 24 inches (61 cm) and the splash zone.

**Note:** Other deck requirements for water attractions do not apply to interactive play attractions.

**(3) WATER SUPPLY, PIPING, CIRCULATION AND FILTRATION.** (a) *General.* All other applicable provisions under s. Comm 90.20 not specified in this section shall apply.

(b) *Water supply.* 1. The recirculation system shall be separate and not be interconnected with the feature pump system, unless otherwise approved by the department.

2. All nozzles that spray from the ground shall be flush with the floor so as to not create a tripping hazard.

3. The total water volume of a balance tank including associated piping shall be at a minimum of four times the combined flow rate of all the attraction pumps and of a sufficient volume so as to allow operation through all cycles of filtration operation

4. The recirculation system shall be separate from that of any other basin.

Note: See Appendix 90.206(3) for further explanatory material.

5. All aboveground piping shall automatically drain. Gravity drains shall be of a capacity of at least 125% of the discharge.

6. All filters shall comply with s. Comm 90.12 (9).

7. The turnover time shall be as listed in Table 90.20-3.

8. The suction intake of the recirculation pump shall be located in the lowest point of the balance tank.

(4) OTHER REQUIREMENTS. (a) Patron access points shall be provided as specified in s. Comm 90.20 (2) (g) and (15) (c).

(b) Fencing of an interactive play attraction is not required.

(c) Any plants or vegetation may not be located in the splash zone area.

SECTION 45. Comm 90.21 is renumbered Comm 90.045.

SECTION 46a. Comm 90 Subchapter V is created to read:

#### **Subchapter V – Slides**

[Note to Revisor: This subchapter title is inserted before s. Comm 90.30.]

SECTION 46b. Comm 90.30 is created to read:

**Comm 90.30 Slides. (1) GENERAL.** All slides installed as an appurtenance to a public swimming pool or water attraction shall be designed, manufactured and installed so as to provide a safe and healthy environment for the rider and other occupants of the facility .

**Note:** For accessibility information, refer to the final accessibility guidelines for recreational facilities, Federal Register, Vol. 67, No. 170, as published Tuesday September 3, 2002.

**(2) DESIGN AND MANUFACTURING.** (a) Pool slides, drop slides and waterslides over 6 feet (1.8 m) in height from the slide entrance to the deck of the pool or water attraction, and incorporating towers to support riders shall be submitted to the department for structural review in accordance with s. Comm 90.05 (2).

(b) Pool slides, drop slides and waterslides shall be submitted for functional review in accordance with s. Comm 90.05 (2).

(c) The total water volume of a separate balancing tank serving runout slides shall be a minimum of two times the combined flow rate the pumps or of a sufficient volume based on velocity and time of the propulsion system and backwash requirements.

(d) Pool slides, drop slides and waterslides shall be so designed that parts with external surfaces that may come in contact with a person using the slide are assembled, arranged and finished so that they are smooth and continuous with and will not cut, pinch, puncture, or cause an abrasion to any person.

(e) All slide flumes shall be designed and constructed so as each person using the waterslide remains inside the flume path during normal use.

(f) All curves, turns, and tunnels on the path of a flume shall be designed and constructed as not to present a hazard to any person using the slide under normal use.

(g) Pool slides, drop slides and waterslides shall be designed to support the intended use.

(h) All stairs, platforms and elevated decks associated with pool slides, drop slides and waterslides shall conform to ch. Comm 62 for guards, handrails and headroom.

(i) For slides without a lifeguard staffing plan, the maximum deck obstruction-width permitted shall be limited to 10 % of the pool perimeter with a maximum individual obstruction-width of 20 feet (6.1 m) and a minimum pool perimeter separation between obstructions of at least 20 feet (6.1 m).

**(3) INSTALLATION.** All slides shall be installed so as to comply with the installation parameters as specified in Table 90.30 –1 and the following requirements where applicable:

(a) For children's slides, the following obstructions shall be permitted without a lifeguard staffing plan:

1. The side view of the obstruction, as viewed from any point, shall be less than 50 square feet (15.25 sq. m)

2. The square footage of the obstruction shall be measured to a height of 6 feet (1.8 m) above the water line.

3. Individual obstructions shall have at least a 10-foot (3.05-m) horizontal separation.

4. No more than 20 % of the pool basin shall be occupied by obstructions.

(b) For waterslides and runout slides, all closed curved flumes shall be a minimum of 32 inches (81.3 cm) in diameter.

(c) For all other slides listed in Table 90.30 –1, the slide terminus shall be designed to not allow riders to cross into the path of another rider.

(d) Pool slides, drop slides and waterslides and the structural supports shall be located to provide at least 10 feet (3.05 m) of clearance from any uninsulated overhead electric power line energized to more than 50 volts, but less than or equal to 50,000 volts. For lines energized to more than 50,000 volts, the minimum clearance shall be increased 0.4 inch for each 1,000 volts over 50,000.

**Table 90.30-1  
INSTALLATION PARAMETERS BY SLIDE TYPE <sup>a</sup>**

<b>Slide Type</b>	<b>Maximum Slide Height Measured Vertically From the Slide Entrance (in feet)</b>	<b>Slide Terminus Drop to Water Level (in inches)</b>	<b>Water Depth Allowed for Slide Installation (in feet)</b>	<b>Minimum Clear Space In Front of Slide Terminus and Pool Wall (in feet)</b>	<b>Minimum Distance from Slide Flume or Entry to Side Obstructions, unless protected (in feet)</b>	<b>Minimum Separation Distance Between Slides in Same Structure Measured from Side of Sliding Surface, unless protected (in feet)</b>	<b>Maximum Overhang Distance for Deck-mounted Slides (Slide terminus extension into pool) (in feet)</b>
Children's slide	≤ 4 to slide terminus	≤ 6	≤ 2	≥ 7.5	≥ 4	As per manufacturer's recommendation	N/A
Pool slide	≤ 4 to deck	≤ 6	≤ 2	≥ 7.5	≥ 4	As per manufacturer's recommendation	N/A
Pool slide, discharging into water ≤ 2 feet deep	> 4 and ≤ 6 to deck	≤ 6	≤ 2	≥ 10	≥ 5	As per manufacturer's recommendation	2
Pool slide, discharging into water ≤ 2 feet deep	> 6 to deck	Not permitted.					
Pool slide, installed in water ≥ 3 feet deep	≤ 6	≤ 6	≥ 3	≥ 15	≥ 5	≥ 5	≤ 2
Pool slide, installed in water ≥ 3 feet deep	> 6	≤ 6	≥ 3	≥ 20	≥ 5	≥ 5	No maximum



**Table 90.30-1 (continued)**  
**INSTALLATION PARAMETERS BY SLIDE TYPE <sup>a</sup>**

<b>Slide Type</b>	<b>Maximum Slide Height Measured Vertically From the Slide Entrance (in feet)</b>	<b>Slide Terminus Drop to Water Level (in inches)</b>	<b>Water Depth Allowed for Slide Installation (in feet)</b>	<b>Minimum Clear Space In Front of Slide Terminus and Pool Wall (in feet)</b>	<b>Minimum Distance from Flume or Entry to Side Obstructions, unless protected (in feet)</b>	<b>Minimum Separation Distance Between Slides in Same Structure Measured from Side of Sliding Surface, unless protected (in feet)</b>	<b>Maximum Overhang Distance for Deck-mounted Slides (Slide terminus extension into pool) (in feet)</b>
Drop Slide, short drop	No limitation	20 to < 30 <sup>b</sup>	3.5 to 6 <sup>b</sup>	≥ 15	≥ 5	≥ 5	No maximum
Drop Slide, long drop	No limitation	30 to 60	6 to 12 <sup>b</sup>	≥ 15	≥ 5	≥ 5	No maximum
Waterslide <sup>c</sup>	No limitation	≤ 6 or as per manufacturer's recommendation	≥ 3	≥ 20	≥ 5	≥ 5	No maximum
Runout Slide	No limitation	N/A	N/A	For deceleration area, as per manufacturer's recommendation	≥ 5	≥ 3	--

N/A = not applicable; ≥ = greater than or equal to; ≤ = less than or equal to.

<sup>a</sup> Slide installation as per manufacturer's requirements if more stringent. For slide types not specifically listed in this table, contact the department.

<sup>b</sup> Interpolation would be used for increasing drop and increasing depth proportionally.

<sup>c</sup> Water slides with a drop shall comply with drop slide requirements in this table.

<sup>d</sup> No minimum separation distance where slide exit prevents exiting over adjacent slide path.

(4) SLIDE FLUME WATER. (a) Except for waterslides, water for flume lubrication shall be a maximum of 10% of the recirculation flow.

(b) The balance tank for runout slide flume lubrication systems shall be at a minimum of two times the combined flow rate of the water attraction pump and of a sufficient volume so as to allow operation through all cycles of filtration operation.

SECTION 47. Comm 90 Subchapter VI (title) is created to read:

**Subchapter VI – Incorporation of Standards**

[Note to Revisor: This subchapter title is inserted before s. Comm 90.40.]

SECTION 48. Comm 90.40 is created to read:

**Comm 90.40 Incorporation of standards by reference. (1) CONSENT.** Pursuant to s. 227.21 (2), Stats., the attorney general and the revisor of statutes have consented to the incorporation by reference of the standards listed in sub. (3).

**Note:** Copies of the adopted standards are on file in the offices of the department, the secretary of state and the revisor of statutes. Copies of the standards may be purchased through the respective organizations listed in Tables 90.40-1 to 90.40-2.

(2) ALTERNATE STANDARDS. (a) 1. Alternate standards that are equivalent to or more stringent than the standards referenced in this code may be used in lieu of the referenced standards when approved by the department or if written approval is issued by the department in accordance with sub. (b).

2. Up on receipt of a fee and a written request, the department may issue an approval for the use of the alternate standard.

3. The department shall review and make a determination on an application for approval within 40 business days of receipt of all forms, fees and documents required to complete the review.

**Note:** Fees for review of standards under this paragraph are listed in ch. Comm 2.

(b) Determination of approval shall be based on an analysis of the alternate standard and the standard referenced in this code, prepared by a qualified independent third party or the organization that published the standard contained in this code.

(c) The department may include specific conditions in issuing an approval, including an expiration date for the approval. Violations of the conditions under which an approval is issued shall constitute a violation of this code.

(d) If the department determines that the alternate standard is not equivalent to or more stringent than the referenced standard, the request for approval shall be denied in writing.

(e) The department may revoke an approval for any false statements or misrepresentations of facts on which the approval was based.

(f) The department may reexamine an approved alternate standard and issue a revised approval at any time.

(3) **ADOPTION OF STANDARDS.** The standards referenced in Tables 90.40-1 to 90.40-2 are hereby incorporated by reference into this chapter.

**Note:** The tables in this section provide a comprehensive listing of all of the standards adopted by reference in this code. For requirements or limitations in how these standards are to be applied, refer to the code section that requires compliance with the standard.

**Table 90.40-1**

<b>ANSI</b>		<b>American National Standards Institute, Inc.</b> 11 W 42 <sup>nd</sup> Street New York, New York 10036 Phone: (212) 642-4980 Web: <a href="http://www.ansi.org/public/std_info.html">www.ansi.org/public/std_info.html</a>
<b>Standard Reference Number</b>	<b>Title</b>	
ANSI/NSF 50-2001	Circulation System Components and Related Materials for Swimming Pools, Spas/Hot Tubs	

**Table 90.40-2**

<b>ASME</b>		<b>American Society of Mechanical Engineers</b> 3 Park Avenue New York, New York 10016-5990 Phone: (800) 843-2763 Web: <a href="http://www.asme.org/catalog/">www.asme.org/catalog/</a>
<b>Standard Reference Number</b>	<b>Title</b>	
ANSI/ASME A112.19.8M-1987 (R1996)	Suction Fittings for Use in Swimming and Wading Pools, Spas, Hot Tubs, and Whirlpool Bathtub Appliances	

(end)

\*\*\*\*\*

**EFFECTIVE DATE**

Pursuant to s. 227.22 (2) (intro.), Stats., these rules shall take effect on the first day of the month following publication in the Wisconsin Administrative Register.

\*\*\*\*\*

## Chapter Comm 90

### APPENDIX

---

The material contained in this appendix is for clarification purposes only. The notes, illustrations, etc., are numbered to correspond to the number of the rule as it appears in the text of the code.

#### A-90.03(15) Plan submittal and fees.

The following is a listing of when the department may waive submittal of pool plans and fees for the reconstruction and alteration of existing pools. This listing is based upon SPGL-7, Guidelines for Pool Designers, June 22, 1992, issued by Department of Health and Family Services.

1. A disinfection system equipped with a positive displacement pump is replaced by an approved pass-through (erosion) type system or visa versa, the replacement of a gas chlorine system with a positive displacement pump or approved pass-through feeder.

**Note:** The installation of a gas chlorine system will require plan submittal and a fee.

2. A recirculation pump is replaced by another pump from a different manufacturer provided that the capacity of the new pump is at least equal to the pump which is replaced.

3. A filter is replaced with an approved filter of the same type but with greater filter media surface.

4. The replacement of metal piping and fittings with the same size PVC piping and fittings.

5. A supplemental disinfecting system is installed (e.g. Ozone, etc.) provided that the halogen residual is maintained as stated in ch. HFS 172 and that there is no decrease in the required water recirculation flow rate.

6. For the installation of a slide 6 foot or less in height, no slide plan review in accordance with ch. Comm 61 is required. Such installations shall meet the guidelines listed in Tables 90.30-1 and 90.30-2.

**A-90.04(6)-1. Authorized Representatives of the Department.** In addition to department staff, the department has designated the following authorized representatives the authority to conduct inspections of construction or modification of any public swimming pool or water attraction for those installations located within the boundary limits of the municipality and which require approval under s. Comm 90.04.

**Note:** This list is maintained by the department and is subject to change.

#### Madison, City of

Madison Department of Public Health  
210 ML King Jr. Blvd., Rm 507  
Madison WI 53703-3346  
Phone: (608) 294-5335  
Fax: (608) 266-4858

#### Portage, County of

Portage County Health & Human Services  
817 Whiting Avenue  
Stevens Point, WI 54481-5292  
Phone: (715) 345 5350  
Fax: (715) 345 5966

#### Milwaukee, City of

City of Milwaukee  
Dept. of Neighborhood Services  
4001 S. 6<sup>th</sup> St. 2<sup>nd</sup> Fl.  
Milwaukee, WI 53221  
Phone: (414) 286-8674

#### Racine, City of

Environmental Health Division  
Racine Health Department  
730 Washington Avenue  
Racine WI 53403  
Phone (262) 636-9203  
Fax: (262) 636-6195

**A-90.09 (2) (b) Outdoor pool deck drain discharge point.**

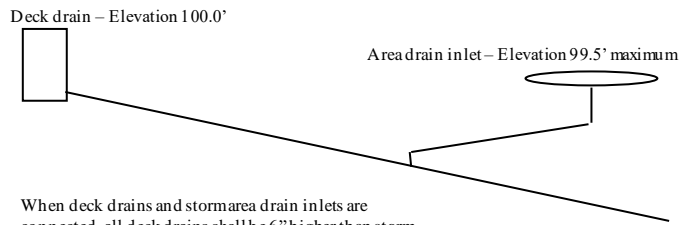
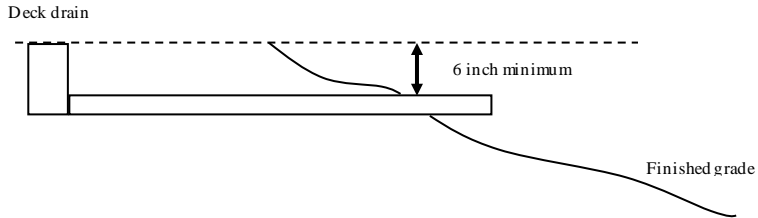

When deck drains and storm area drain inlets are connected, all deck drains shall be 6" higher than storm area drain inlets. It must be demonstrated that regardless of the location of any clogged drain, wastewater would discharge from the area drain inlet prior to ponding on the deck of the pool.

**A-90.11 (6) (b) Main drain piping.**

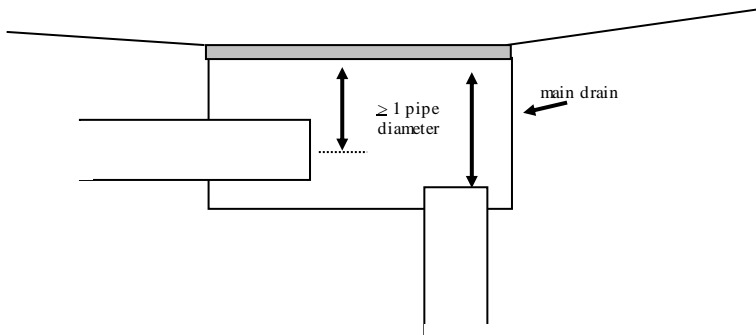

**A-90.16(1) Minimum number of plumbing facilities.** Sections 1003.2.2.2, 1003.2.2.9, and 2902.1 of the IBC, Tables 1003.2.22 (partial) and 2902.1 (partial) and respective text are reprinted for use within s. Comm 90.16. These tables and respective text are contained in the Commercial Building Code, chs. Comm 61 to 67.

**Table 1003.2.2.2 (partial)  
MAXIMUM FLOOR AREA ALLOWANCES PER OCCUPANT**

OCCUPANCY	FLOOR AREA IN SQ. FT. PER OCCUPANT
Skating rinks, swimming pools	
Rink and pool	50 gross
Decks	15 gross

**Section 1003.2.2.9 Fixed seating.** For areas having fixed seats and aisles, the occupant load shall be determined by the number of fixed seats installed therein.

For areas having fixed seating without dividing arms, the occupant load shall not be less than the number of seats based on one person for each 18 inches (457 mm) of seating length.

The occupant load of seating booths shall be based on one person for each 24 inches (610 mm) of booth seat length measured at the backrest of the seating booth.

**Table 2902.1(partial)  
MINIMUM NUMBER OF PLUMBING FACILITIES <sup>a</sup>**

OCCUPANCY	WATER CLOSETS (see s. Comm 62.2902(1) for urinals)		LAVATORIES	BATHTUBS/ SHOWERS	DRINKING FOUNTAINS (see the <i>International Plumbing Code</i> )	OTHERS
	Male	Female				
Theatres, halls, museums, etc. <sup>*</sup>	1 per 100	1 per 75	1 per 200	--	1 per 500	1 service sink

<sup>\*</sup> Public swimming pools and water attractions are included here.

**A-90.16(2)-2 – Nationally Recognized Listing Agencies Acceptable to the Department.**

American Gas Association (AGA)  
400 N. Capitol Street, N.W.  
Washington, DC 20001  
Phone: (202) 824-7000  
Fax: (202) 824-7115  
Web page: <http://www.aga.org>

ETL Intertek Testing Services NA, Inc.  
(ITS)  
3233 US Route 11  
Cortland, NY 13045  
Phone: (607) 753-6711  
Web page: [www.intertek-testing.com](http://www.intertek-testing.com)

American Society of Mechanical Engineers  
ASME International  
1828 L Street, NW, Ste. 906  
Washington, DC 20036  
Phone: (202) 785-3756  
Fax: (202) 429-9417  
Web page: <http://www.inforcentral@asme.org>

Underwriters Laboratories Inc. (UL)  
333 Pfingsten Road  
Northbrook, IL 60062-2096 USA  
Phone: (847) 272-8800  
Fax: (847) 272-8129  
E-mail: [northbrook@us.ul.com](mailto:northbrook@us.ul.com)  
Web page: <http://www.ul.org/>

**A-90.18 (2)-1. Filling options for wading pool or whirlpool from a swimming pool.**

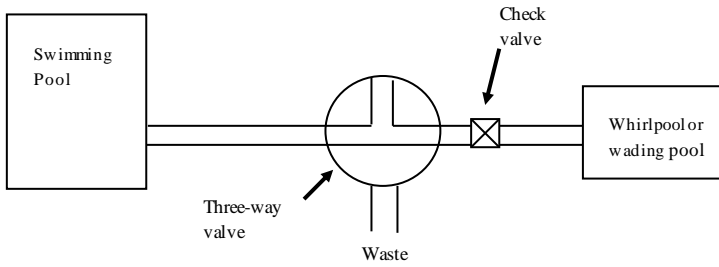

**A-90.18(2)-2. Operational position option for a three-way valve filling wading pool or whirlpool from a swimming pool.**

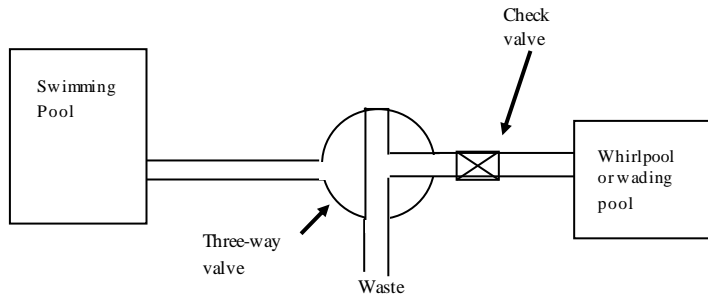

**A-90.18(3) Obstructions extending from the bottom of a wading pool.** In this sample sketch, the obstructed area between the water level to height of 6 feet (using  $\frac{1}{2}$  foot as the width of the obstruction) equals 3 square feet. As provided in s. Comm 90.18, this obstruction would be permitted in a wading pool without a lifeguard staffing plan.

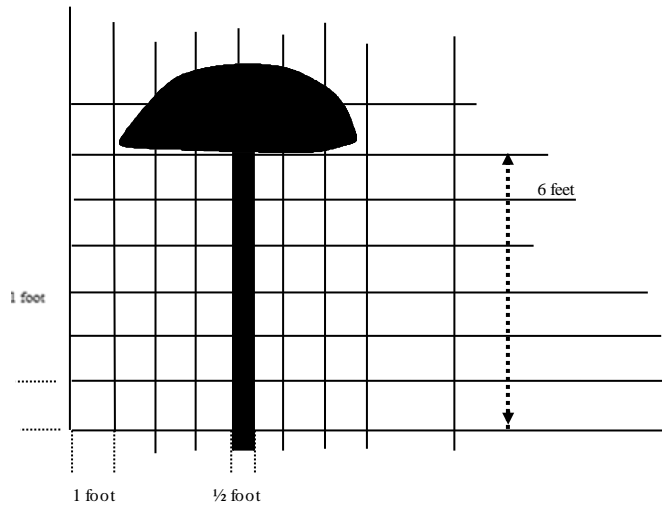



**A-90.19(6) Whirlpool location.** Sample sketch depicting whirlpool location and measurements for access, as specified in s. Comm 90.19(6)(a) 2.

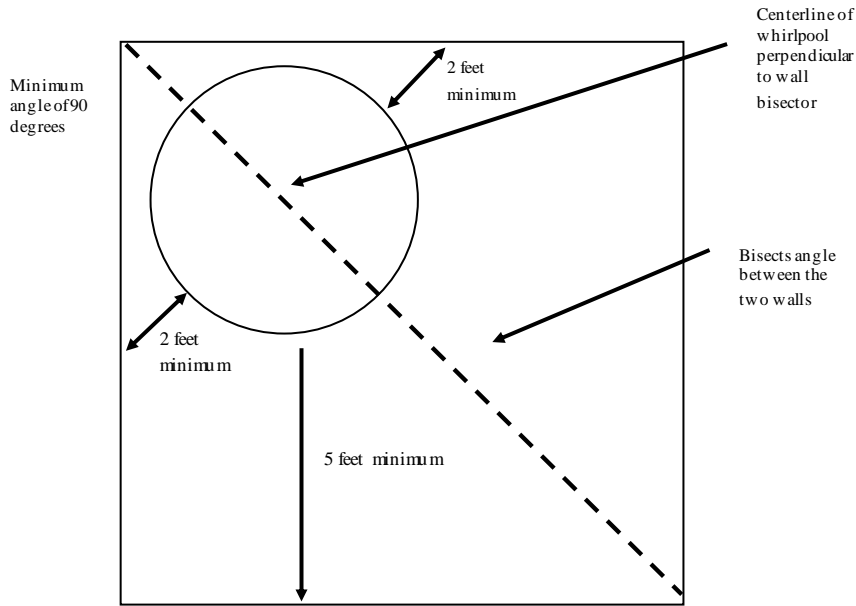

**A-90.20(8)-1. Drain layout details for suction fittings.**

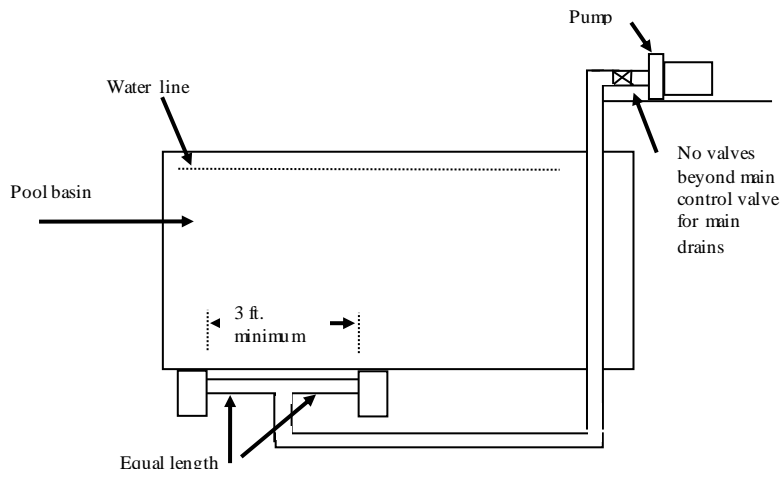

**A-90.20(8)-2. Suction outlet options.**

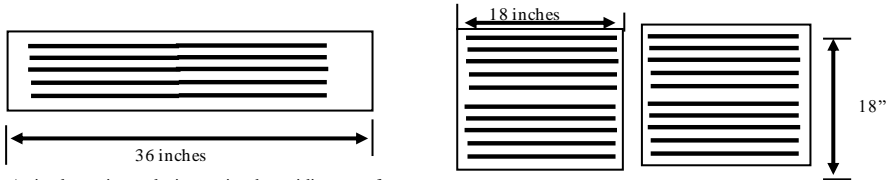

A single suction outlet is permitted providing one of the dimensions (length or width) is at least 36 inches.

Two suction fittings 18" X 18" may be closer than 3 feet apart.

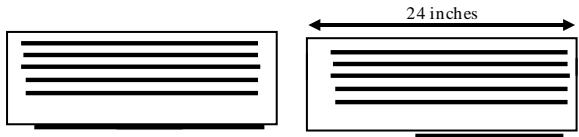

Two suction fittings that have at least one dimension (length or width) that is 24" or more, may be located within 3 feet of one another.

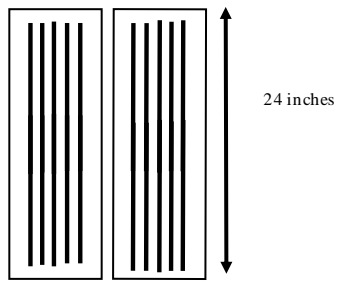

**A-90.20(12)-1. Swimming pool source and makeup water.** A partial listing of s. Comm 82.70 Table 82.70-1 relating to plumbing treatment standards is listed herein.

**Table 82.70-1 (partial)  
PLUMBING TREATMENT STANDARDS**

Intended Use	Plumbing Treatment Standards
4. Swimming pool makeup water	NR 811 and 812 approved sources
5. Swimming pool fill water	HFS 172 requirements

**A-90.20(12)-2. Allowable discharge points for pool wastewater.** The following table has been copied from ch. Comm 82 relating to allowable discharge points for public swimming pools.

**Table 82.38 – 1  
ALLOWABLE DISCHARGE POINTS BY FIXTURE OR SPECIFIC USES**

Use or Fixture	Allowable Discharge Points					
	POWTS <sup>a</sup>	Municipal Sanitary Sewer	Municipal Storm Sewer	Ground Surface	Combined Sanitary-Storm Sewer	Subsurface Dispersal <sup>i</sup>
1. Cross connection control device or assembly [see s. Comm 82.33 (9) (k)]	X	X		X <sup>b, c, e</sup>	X	
2. Domestic wastewater	X	X			X	
3. Condensate from high efficiency furnace or water heater	X	X			X	
4. Drinking fountain	X	X	X	X <sup>b</sup>	X	X
5. Elevator pit drain [see s. Comm 82.33 (9) (f)]			X	X <sup>b</sup>	X	X
6. Enclosed public parking levels	X	X		X <sup>b</sup>	X	X
7. Industrial wastewater <sup>h</sup>	X <sup>f</sup>	X			X	
8. Municipal well pump house floor drain and sink	X	X		X <sup>b</sup>	X	X
9. One- and 2-family garage floor area [see s. Comm 82.34 (4) (b)]	X	X		X <sup>b</sup>	X	
10. Storm water, groundwater and clear water	X	X <sup>g</sup>	X <sup>c</sup>	X <sup>b</sup>	X	X
11. Swimming pool or wading pool--diatomaceous earth filter backwash	X	X			X	
12. Swimming pool or wading pool--drain wastewater	X	X <sup>b</sup>	X <sup>b,c</sup>	X <sup>b,c</sup>	X <sup>b</sup>	X
13. Swimming pool or wading pool--sand filter backwash	X	X <sup>b</sup>	X <sup>b,c</sup>	X <sup>b,c</sup>	X <sup>b</sup>	X
14. Water heater temperature and pressure relief valve [see s. Comm 82.40 (5)]	X	X	X	X <sup>b</sup>	X	X
15. Wastewater from water treatment device	X	X <sup>g</sup>	X <sup>c</sup>	X <sup>b,c</sup>	X	X
16. Whirlpool backwash drain and wastewater	X	X	X <sup>c</sup>	X <sup>b,c</sup>	X	
17. Discharges not specifically listed above						Contact the department

<sup>a</sup> Allowed when the POWTS is designed to include designated wastewater.

<sup>b</sup> Unless prohibited by local municipality and when no nuisance is created.

<sup>c</sup> A discharge permit may be required by the department of natural resources.

<sup>e</sup> Allowed for exterior installation and when no sanitary sewer is in the building.

<sup>f</sup> Refer to the department of natural resources for discharge regulations.

<sup>g</sup> Fifty gpd clearwater.

<sup>h</sup> The department of natural resources may require WPDES permits for industrial discharges and may allow other options.

<sup>i</sup> Subsurface dispersal must comply with s. Comm 82.365.

**A 90.20 (3) Calculating turnover times.**

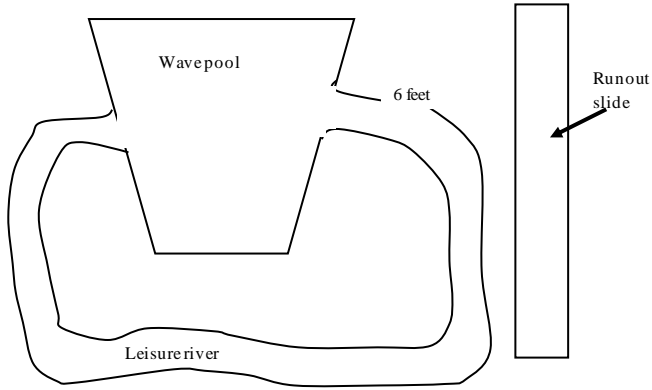

Where a runout slide is connected to a pool basin, the following method is used to calculate turnover time.

- Leisure river = 40,000 gallons at a turnover time of 2 hours
- Wave pool = 50,000 gallons at a turnover time of 2 hours
- Basin requires a turnover time of 2 hours for 90,000 gallons

The first runout slide connected to a basin requires that an “imaginary plunge pool” volume is considered in the calculation. That volume must be turned over at a one-hour turnover time, as provided in Table Comm 90.20-3. Subsequent runout slides are calculated with an additional 4,500 gallons per slide.

This ‘imaginary volume’ is subtracted from the total volume of the basin:  
 As an example, a volume of 6,700 gallons is subtracted from the total volume of the basin.

$$90,000 \text{ gallons} - 6,700 \text{ gallons} = 83,300 \text{ gallons}$$

The remainder of the basin (83,300 gallons) will have a turnover time of 2 hours, while the 6,700 gallons will be turned over in one hour.

- 83,300 at 2-hour turnover time requires a pump with a discharge rate of 695 gpm (83,300/120)
- 6,700 at one-hour turnover time requires a pump with a discharge rate of 112 gpm (6,700/60)

The pump capacity at the total dynamic head required is 807 gpm

The basin plus the runout slide turnover time for this example is: 90,000 gallons/807 gpm or 1.86 hours.

A-90.30(3)(a) Children's slide obstructions in wading pools.

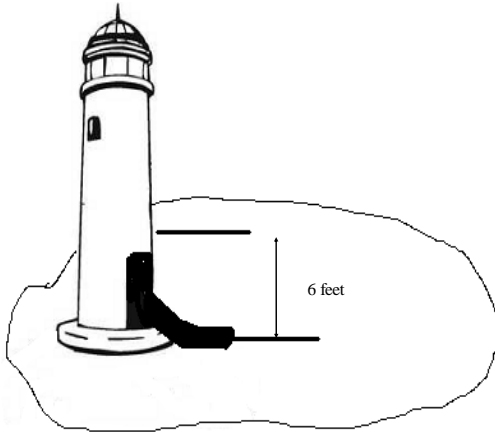

The square footage of the obstruction between the water level to a height of 6 feet for the obstruction shown is 48 square feet. This obstruction is code compliant, as provided in s. Comm 90.30, without a lifeguard staffing plan.

(end)